

PARTIAL SWING-OUT RACK FRAME



APPLICATION

This 19-in. Rack Frame is used when a smaller, medium-duty swing-out frame is desired. Light-weight rack equipment fits nicely into this 800-mm tall swing-out frame, providing 90 degrees of rotation and increased accessibility.

FEATURES

- Side hinge brackets are used to mount the swing frame, allowing free access above and below the swing frame
- Used with any height enclosure and hinged on the right or left

SPECIFICATIONS

- Furnished with hinges, two quarter-turn latches and mounting hardware
- Complies with ANSI/EIA RS-310-D rack mounting standards
 1. Swing-Out Rack Frame assemblies are supplied with mounting supports. Swing-Out Rack Frames can also be installed in right, left or both bays of 1200-mm wide frames using center uprights.
 2. Swing-out mounting supports mount to inside of frame at any vertical location.
 3. Mounting supports and swing-out frame can be located deeper into frame using grid system straps. Deeper mounting affects the degree of opening of swing-out frame.

FINISH

- Polyester powder paint; RAL 7035 textured light gray standard
- Custom colors available

LOAD RATING

Maximum load rating is 100 lb [45 kg]

BULLETIN: P20

Catalog Number	W (mm)	W (in.)	Fits Frame Width (mm)	Rack Units
PSF6	507	20.0	600	16
PSF8	697	27.4	800	16

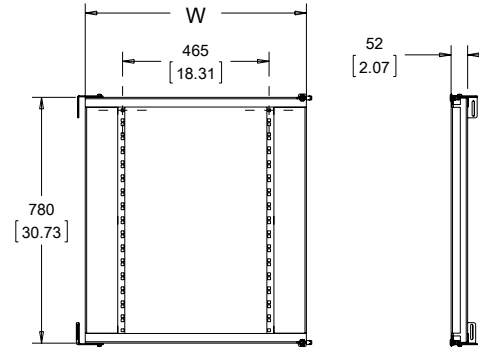

89146939

HEAVY-DUTY SWING-OUT RACK FRAME

- Allows 19-in. rack equipment to pivot out of the enclosure frame for better accessibility. The frames mount on hinges capable of 120-degree rotation. Hinges that provide 170-degree rotation are optional.
- Spring-loaded pivot post makes installation easy
- Rack Frames are available for 600-, 700- and 800-mm wide enclosure frames
- Mounting supports for an 800-mm wide enclosure frame permit you to either center the rack-mounting frame or position it right or left. The frame can also pivot from either the left or the right for maximum flexibility.
- Mounting supports can be assembled to the top and bottom of the frame for full-height rack-mounting frames. Smaller rack-mounting frames can be mounted to the vertical frame members or to the grid straps. Order separately.
- Furnished with hinges, two quarter-turn latches and mounting hardware RAL 7035 textured gray finish
- Complies with ANSI/EIA RS-310-D rack-mounting standards
- Maximum equipment load is 300 lb.
- Mounting holes accommodate either English or metric cage nuts, which are ordered separately
 1. *Swing-Out Rack Frame assemblies are supplied with mounting supports. Swing-Out Rack Frames can also be installed in right, left or both bays of 1200-mm wide frames using center uprights.*
 2. *Swing-out mounting supports mount to inside of frame at any vertical location.*
 3. *Mounting supports and swing-out frame can be located deeper into frame using grid system straps. Deeper mounting affects the degree of opening of swing-out frame.*

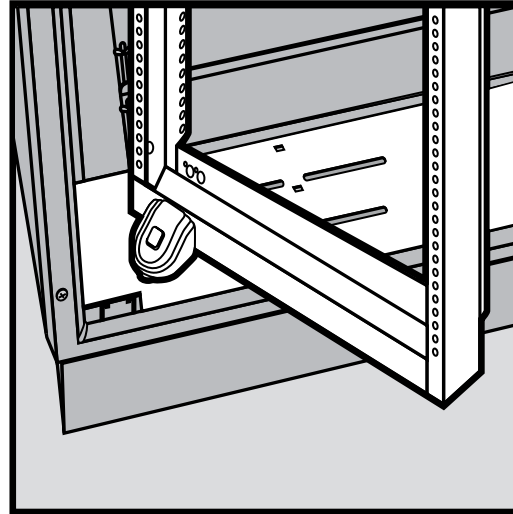

BULLETIN: P20

Catalog Number	H mm/in.	W mm/in.	Rack Units	Fits Frame Height	Fits Frame Width
PSF76	538	496	10	700 or taller	600
	21.18	19.53			
PSF77	538	496	10	700 or taller	700
	21.18	19.53			
PSF78	538	496	10	700 or taller	800
	21.18	19.53			
PSF146	1215	496	25	1400 or taller	600
	47.83	19.53			
PSF148	1215	496	25	1400 or taller	800
	47.83	19.53			
PSF168	1438	496	30	1600 or taller	800
	63.58	19.53			
PSF186	1615	496	34	1800 or taller	600
	63.58	19.53			
PSF188	1615	496	34	1800 or taller	800
	63.58	19.53			
PSF206	1838	496	39	2000 or taller	600
	72.36	19.53			
PSF207	1838	496	39	2000 or taller	700
	72.36	19.53			
PSF208	1838	496	39	2000 or taller	800
	72.36	19.53			
PSF226	2015	496	43	2200 tall	600
	79.33	19.53			
PSF227	2015	496	43	2200 tall	700
	79.33	19.53			
PSF228	2015	496	43	2200 tall	800
	79.33	19.53			

Standard 120° Frame Hinging

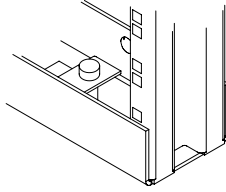

120° Mounting Position

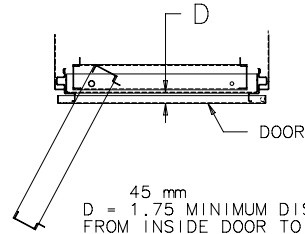

Maximum Installation Depth for 600 mm Wide Enclosures

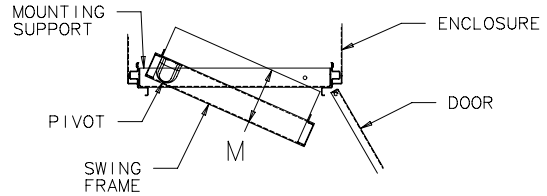
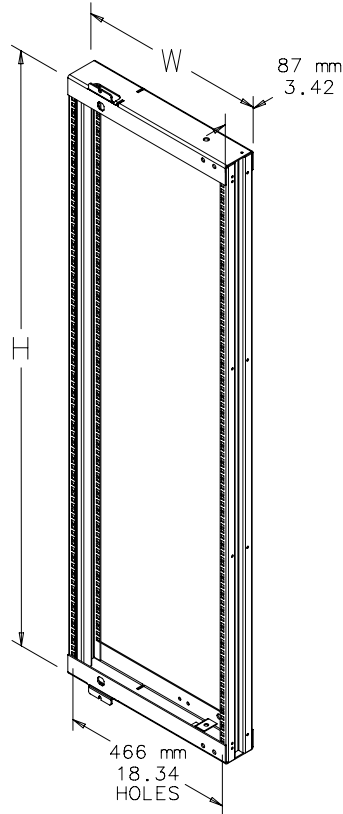

M = Max Installation Depth = 216 mm (8.50 in.)

Maximum Installation Depth for 700 mm Wide Enclosures

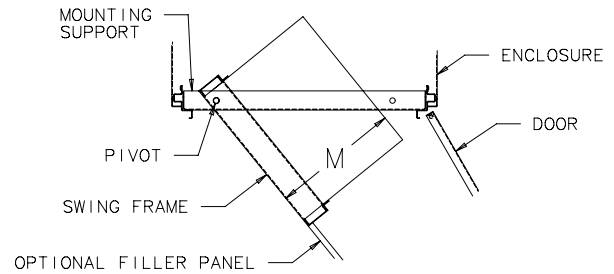

M = Max Installation Depth = 394 mm (15.50 in.)

Maximum Installation Depth for 800 mm Wide Enclosures

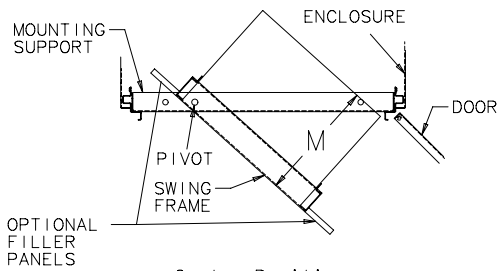

Center Position

M = Max Installation Depth = 394 mm (15.50 in.)

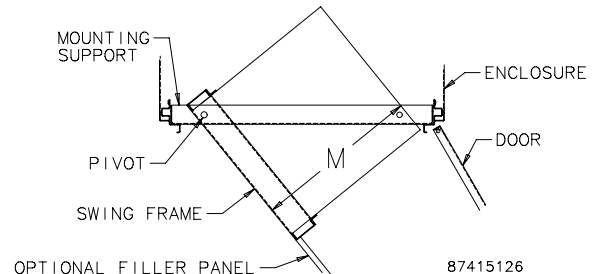

Side Position

M = Max Installation Depth = 514 mm (20.25 in.)

87415126

170-DEGREE HINGE KIT

Use this kit in conjunction with the Heavy-Duty Swing-Out Frame. It provides increased accessibility to the back of rack equipment.

BULLETIN: P20

Catalog Number	Fits Cabinets
PSF170K	600, 700 and 800

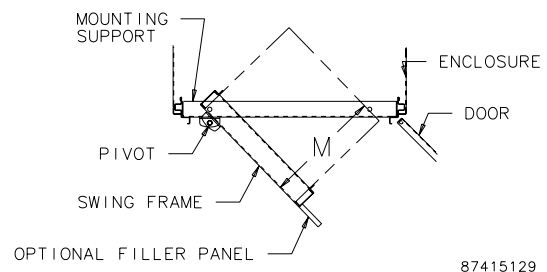
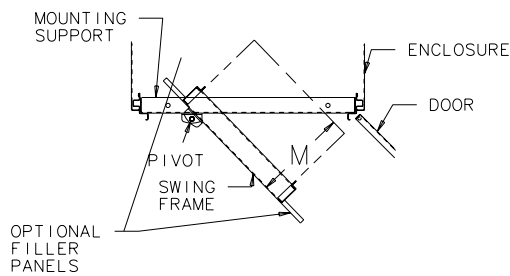
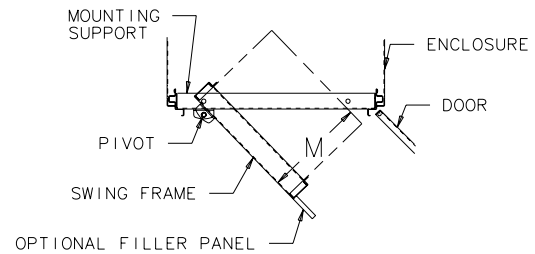
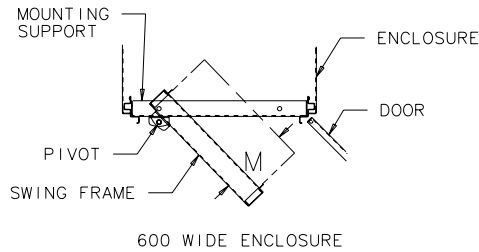
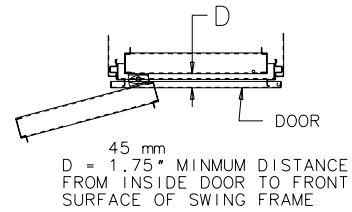
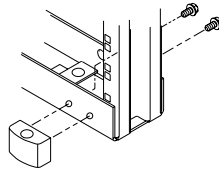
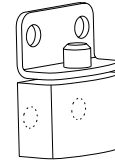

87415129

STOP ARM KIT

Used with Heavy-Duty Swing-Out Rack Frames to lock the frame in the open position. Consists of stop arm and mounting hardware.

BULLETIN: P20

Catalog Number	Description
PSAK120	120-degree Stop Arm Kit

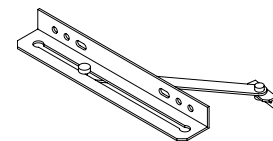

87794539



Used when mounting the PROLINE G2 Heavy-Duty Swing-Out Rack Frames in 800-mm wide frames. The Filler Panel occupies the extra space between the frame and the swing frame. Includes a handle and all the hardware for mounting to the Swing-Out Rack Frame.

BULLETIN: P20

Catalog Number	Swing Frame Height mm	Enclosure Width mm	Mounting
PFPK77LR	700	700	Left or Right
PFPK78C	700	800	Center
PFPK147LR	1400	700	Left or Right
PFPK148C	1400	800	Center
PFPK167LR	1600	700	Left or Right
PFPK168LR	1600	800	Left or Right
PFPK168C	1600	800	Center
PFPK187LR	1800	700	Left or Right
PFPK188LR	1800	800	Left or Right
PFPK188C	1800	800	Center
PFPK208LR	2000	800	Left or Right
PFPK208C	2000	800	Center
PFPK227LR	2200	700	Left or Right
PFPK228LR	2200	800	Left or Right
PFPK228C	2200	800	Center

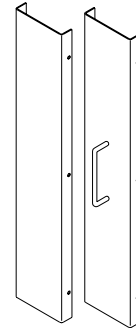
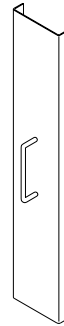

87415128

Notes