

CONCEPT HMI OVERVIEW

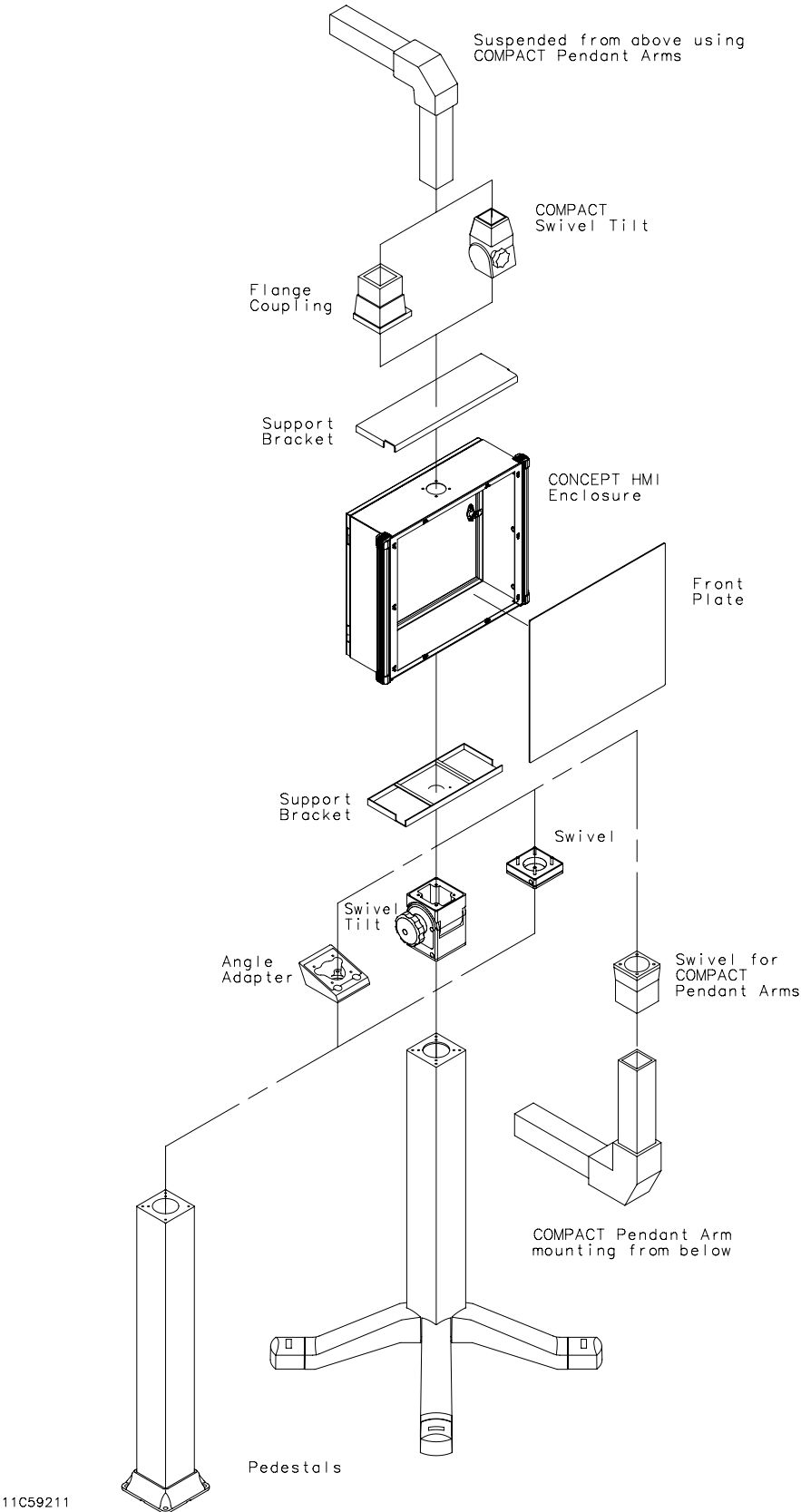

These human-machine interface (HMI) enclosures are appropriate for applications incorporating flat-screen devices, pushbuttons and other similar devices. Available in three depths, the system’s capability for pendant or pedestal mounting offers exceptional design flexibility.





INDUSTRY STANDARDS

UL 508A Listed; Type 4, 12; File Number E61997
 cUL Listed per CSA C22.2 No. 94; Type 4, 12; File No. E61997

NEMA Type 4, 12
 IEC 60529, IP66

APPLICATION

A traditional landscape-oriented HMI enclosure made of light-gray steel, the Concept HMI is unique among HMI enclosure systems when you need a range of customization options. This pendant- or pedestal-mounted system has many possible configurations and modifications, including a removable front plate that makes it easy to install HMI components and the ability to accommodate cutouts anywhere on the enclosure.

FEATURES

- Predrilled hole in top for pendant arm mounting
- Pedestal mounting when enclosure is inverted
- Integral handle extrusions have a comfort grip that extends the length of the profile; standard color black
- Blue integral handle extrusions and end caps are also available
- Hinged rear corner-formed door has a single-point latch, seamless foam-in-place gasket and panel studs
- Aluminum front plate

SPECIFICATIONS

- Body manufactured from 14 gauge steel
- Front plate is .125-in. aluminum
- Grounding stud on body; bonding provision on door
- Simple easy-to-remove and install hinge pins with built-in captive clip
- High-torque threadless studs and fasteners on door

FINISH

Enclosure body and front plate have RAL 7035 light-gray polyester powder paint finish. Standard handle extrusions and end caps have RAL 9005 black polyester powder paint finish.

ACCESSORIES

- See also Accessories Chapter.*
- Industrial Corrosion Inhibitors
 - Thermoplastic Data Pocket
 - Electric Heater
 - Compact Cooling Fans
 - Touch-Up Paint

MODIFICATION AND CUSTOMIZATION

Hoffman excels at modifying and customizing products to your specifications. Contact your local Hoffman sales office or distributor for complete information.

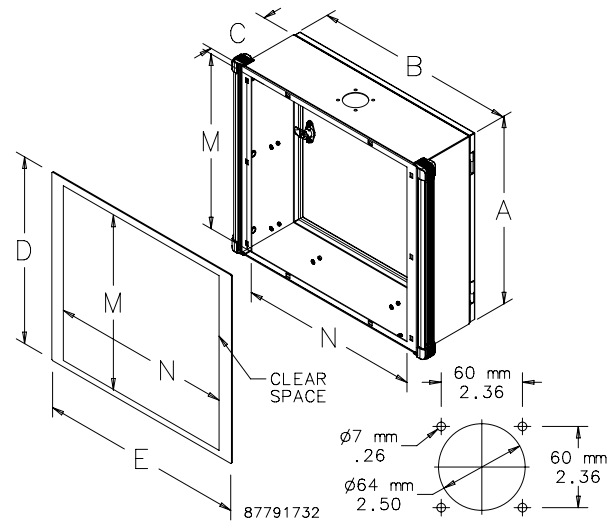

BULLETIN: C2

Standard Product **Concept HMI Enclosures with Black Extrusions**

Catalog Number	AxBxC mm	AxBxC in.	Front Opening M (mm)	Front Opening M (in.)	Front Opening N (mm)	Front Opening N (in.)	Front Plate D (mm)	Front Plate D (in.)	Front Plate E (mm)	Front Plate E (in.)	Product Weight (lb.)
CP253512	250 x 350 x 120	9.84 x 13.78 x 4.72	210	8.27	280	11.02	250	9.86	361	14.22	10.5
CP304012	300 x 400 x 120	11.81 x 15.75 x 4.72	260	10.24	330	12.99	300	11.83	411	16.19	14.9
CP323512	320 x 350 x 120	12.60 x 13.78 x 4.72	285	11.22	280	11.02	325	12.81	361	14.22	16.5
CP354512	350 x 450 x 120	13.78 x 17.72 x 4.72	310	12.20	380	14.96	350	13.79	461	18.16	20.0
CP354518	350 x 450 x 180	13.78 x 17.72 x 7.09	310	12.20	380	14.96	350	13.79	461	18.16	22.3
CP354530	350 x 450 x 300	13.78 x 17.72 x 11.80	310	12.20	380	14.96	350	13.79	461	18.16	26.9
CP374012	370 x 400 x 120	14.57 x 15.75 x 4.72	335	13.19	330	12.99	375	14.78	411	16.19	20.0
CP405012	400 x 500 x 120	15.75 x 19.69 x 4.72	360	14.17	430	16.93	400	15.76	511	20.13	24.3
CP405018	400 x 500 x 180	15.75 x 19.69 x 7.09	360	14.17	430	16.93	400	15.76	511	20.13	26.5
CP405030	400 x 500 x 300	15.75 x 19.69 x 11.80	360	14.17	430	16.93	400	15.76	511	20.13	30.9
CP424512	420 x 450 x 120	16.54 x 17.72 x 4.72	385	15.16	380	14.96	425	16.75	461	18.16	23.9
CP424518	420 x 450 x 180	16.54 x 17.72 x 7.09	385	15.16	380	14.96	425	16.75	461	18.16	25.8
CP424530	425 x 450 x 300	16.73 x 17.72 x 11.80	385	15.16	380	14.96	425	16.75	461	18.16	30.2
CP455512	450 x 550 x 120	17.72 x 21.65 x 4.72	410	16.14	480	18.90	450	17.73	561	22.10	28.6
CP455518	450 x 550 x 180	17.72 x 21.65 x 7.09	410	16.14	480	18.90	450	17.73	561	22.10	31.0
CP455530	450 x 550 x 300	17.72 x 21.65 x 11.80	410	16.14	480	18.90	450	17.73	561	22.10	35.8
CP475012	470 x 500 x 120	18.50 x 19.69 x 4.72	435	17.13	430	16.93	475	18.72	511	20.13	28.0
CP475018	470 x 500 x 180	18.50 x 19.69 x 7.09	435	17.13	430	16.93	475	18.72	511	20.13	30.2
CP475030	475 x 500 x 300	18.70 x 19.69 x 11.80	435	17.13	430	16.93	475	18.72	511	20.13	34.6
CP486012	480 x 600 x 120	18.90 x 23.62 x 4.72	440	17.32	530	20.87	480	18.90	611	24.06	32.2
CP486018	480 x 600 x 180	18.90 x 23.62 x 7.09	440	17.32	530	20.87	480	18.90	611	24.06	34.6
CP486030	480 x 600 x 300	18.90 x 23.62 x 11.80	440	17.32	530	20.87	480	18.90	611	24.06	39.4
CP525512	520 x 550 x 120	20.47 x 21.65 x 4.72	485	19.09	480	18.90	525	20.68	561	22.10	32.5
CP525518	520 x 550 x 180	20.47 x 21.65 x 7.09	485	19.09	480	18.90	525	20.68	561	22.10	34.9
CP525530	525 x 550 x 300	20.67 x 21.65 x 11.80	485	19.09	480	18.90	525	20.68	561	22.10	39.7
CP556012	555 x 600 x 120	21.85 x 23.62 x 4.72	515	20.28	530	20.87	555	21.86	611	24.06	36.8
CP556018	555 x 600 x 180	21.85 x 23.62 x 7.09	515	20.28	530	20.87	555	21.86	611	24.06	38.8
CP556030	555 x 600 x 300	21.85 x 23.62 x 11.80	515	20.28	530	20.87	555	21.86	611	24.06	43.6

Standard Product **Concept HMI Enclosures with Blue Extrusions**

Catalog Number	AxBxC mm	AxBxC in.	Front Opening M (mm)	Front Opening M (in.)	Front Opening N (mm)	Front Opening N (in.)	Front Plate D (mm)	Front Plate D (in.)	Front Plate E (mm)	Front Plate E (in.)	Product Weight (lb.)
CP253512B	250 x 350 x 120	9.84 x 13.78 x 4.72	210	8.27	280	11.02	250	9.86	361	14.22	10.5
CP304012B	300 x 400 x 120	11.81 x 15.75 x 4.72	260	10.24	330	12.99	300	12.99	411	16.19	14.9
CP323512B	320 x 350 x 120	12.60 x 13.78 x 4.72	285	11.22	280	11.02	325	12.81	361	14.22	16.5
CP354512B	350 x 450 x 120	13.78 x 17.72 x 4.72	310	12.20	380	14.96	350	13.79	461	18.16	20.0
CP354518B	350 x 450 x 180	13.78 x 17.72 x 7.09	310	12.20	380	14.96	350	13.79	461	18.16	22.3
CP354530B	350 x 450 x 300	13.78 x 17.72 x 11.80	310	12.20	380	14.96	350	13.79	461	18.16	26.9
CP374012B	370 x 400 x 120	14.57 x 15.75 x 4.72	335	13.19	330	12.99	375	14.78	411	16.19	20.0
CP405012B	400 x 500 x 120	15.75 x 19.69 x 4.72	360	14.17	430	16.93	400	15.76	511	20.13	24.3
CP405018B	400 x 500 x 180	15.75 x 19.69 x 7.09	360	14.17	430	16.93	400	15.76	511	20.13	26.5
CP405030B	400 x 500 x 300	15.75 x 19.69 x 11.80	360	14.17	430	16.93	400	15.76	511	20.13	30.9
CP424512B	420 x 450 x 120	16.54 x 17.72 x 4.72	385	15.16	380	14.96	425	16.75	461	18.16	23.9
CP424518B	420 x 450 x 180	16.54 x 17.72 x 7.09	385	15.16	380	14.96	425	16.75	461	18.16	25.8
CP424530B	425 x 450 x 300	16.73 x 17.72 x 11.80	385	15.16	380	14.96	425	16.75	461	18.16	30.2
CP455512B	450 x 550 x 120	17.72 x 21.65 x 4.72	410	16.14	480	18.90	450	17.73	561	22.10	28.6
CP455518B	450 x 550 x 180	17.72 x 21.65 x 7.09	410	16.14	480	18.90	450	17.73	561	22.10	31.0
CP455530B	450 x 550 x 300	17.72 x 21.65 x 11.80	410	16.14	480	18.90	450	17.73	561	22.10	35.8
CP475012B	470 x 500 x 120	18.50 x 19.69 x 4.72	435	17.13	430	16.93	475	18.72	511	20.13	28.0
CP475018B	470 x 500 x 180	18.50 x 19.69 x 7.09	435	17.13	430	16.93	475	18.72	511	20.13	30.2
CP475030B	475 x 500 x 300	18.70 x 19.69 x 11.80	435	17.13	430	16.93	475	18.72	511	20.13	34.6
CP486012B	480 x 600 x 120	18.90 x 23.62 x 4.72	440	17.32	530	20.87	480	18.90	611	24.06	32.2
CP486018B	480 x 600 x 180	18.90 x 23.62 x 7.09	440	17.32	530	20.87	480	18.90	611	24.06	34.6
CP486030B	480 x 600 x 300	18.90 x 23.62 x 11.80	440	17.32	530	20.87	480	18.90	611	24.06	39.4
CP525512B	520 x 550 x 120	20.47 x 21.65 x 4.72	485	19.09	480	18.90	525	20.68	561	22.10	32.5
CP525518B	520 x 550 x 180	20.47 x 21.65 x 7.09	485	19.09	480	18.90	525	20.68	561	22.10	34.9
CP525530B	525 x 550 x 300	20.67 x 21.65 x 11.80	485	19.09	480	18.90	525	20.68	561	22.10	39.7
CP556012B	550 x 600 x 120	21.65 x 23.62 x 4.72	515	20.28	530	20.87	555	21.86	611	24.06	36.8
CP556018B	550 x 600 x 180	21.65 x 23.62 x 7.09	515	20.28	530	20.87	555	21.86	611	24.06	38.8
CP556030B	555 x 600 x 300	21.85 x 23.62 x 11.80	515	20.28	530	20.87	555	21.86	611	24.06	43.6

ACCESSORY HANDLE KIT



Install handles on the integral handle extrusions or the bottom of the enclosure. Handle is 13.40-in. long and can be cut down to fit smaller enclosure sizes. Aluminum tube has RAL 9005 black polyester powder paint finish. Plastic ends are RAL 9005 black. Kit includes one pair of handles and all mounting hardware.

BULLETIN: C2

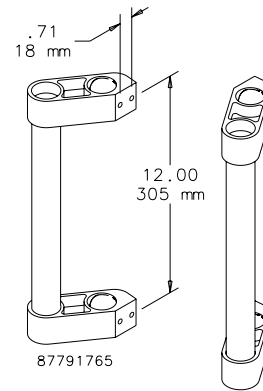

Catalog Number	Description	Product Weight (lb.)
CHDLK	One pair of handles and mounting hardware	1.7

CLIPBOARD/WHITE BOARD



The Clipboard/White Board can be installed on either handle extrusion. All mounting hardware and installation instructions are included. Finished with white paint. Dry-erase markers can be used on the front writing surface.

BULLETIN: C2

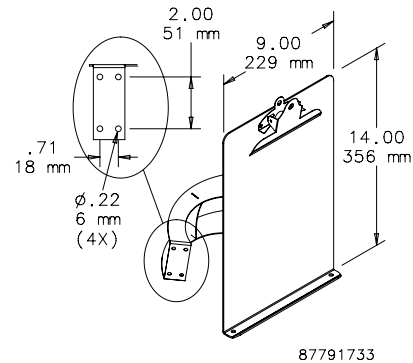

Catalog Number	Description	Product Weight (lb.)
CCLPBRD	Clipboard and mounting hardware	2

DRIVE ACCESS DOOR



Drive door can be installed only on enclosures to access internal disk drives. Key-locking latch is included. An installation template is included in the installation instructions. All installation hardware is included. RAL 7035 light-gray polyester powder paint finish. Hinges have RAL 9005 black polyester powder paint finish. Maintains NEMA Type 12 rating. Cannot be used on 120-mm deep enclosures.

BULLETIN: C2

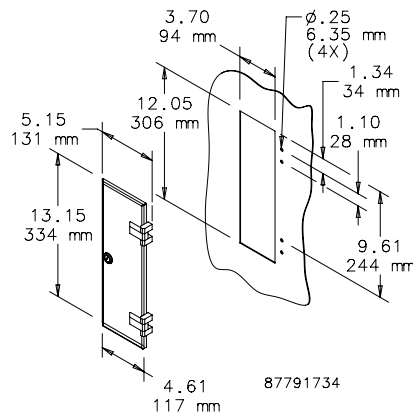

Catalog Number	Description	Product Weight (lb.)
CDACCDR	Door and installation hardware	1.7

KEYBOARD TRAY

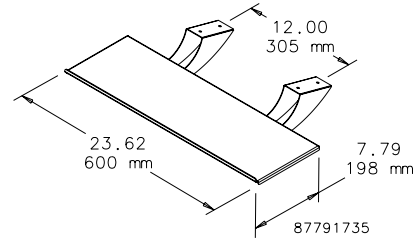

The Keyboard Tray mounts under the enclosure for a keyboard and mouse. All mounting hardware is included. The tray has RAL 7035 light-gray polyester powder paint finish.

BULLETIN: C2

Catalog Number	Description	Product Weight (lb.)
CKBT	Keyboard tray and mounting hardware	3.2

REPLACEMENT FRONT PLATE

Aluminum plate is .125-in. thick. Finish is RAL 7035 light-gray polyester powder paint. Mounting hardware is included.

BULLETIN: C2

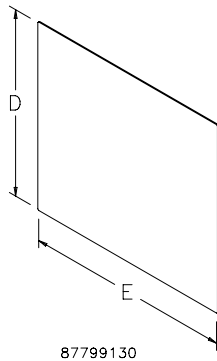

87799130

Catalog Number	D mm/in.	E mm/in.	Fits Enclosure A x B mm/in.	Product Weight (lb.)
CPFP2535	250 9.84	361 14.22	250 x 350 9.84 x 13.78	1.7
CPFP3040	300 11.81	411 16.19	300 x 400 11.81 x 15.75	2.4
CPFP3235	325 12.80	361 14.22	325 x 350 12.80 x 13.78	2.3
CPFP3545	350 13.78	461 18.16	350 x 450 13.78 x 17.72	3.1
CPFP3740	375 14.76	411 16.19	375 x 400 14.76 x 15.75	3.0
CPFP4050	400 15.75	511 20.13	400 x 500 15.75 x 19.68	3.9
CPFP4245	425 16.73	461 18.16	425 x 450 16.73 x 17.72	3.8
CPFP4555	450 17.72	561 22.10	450 x 550 17.72 x 21.65	4.8
CPFP4750	475 18.70	511 20.13	475 x 500 18.70 x 19.68	4.7
CPFP4860	480 18.90	611 24.06	480 x 600 18.90 x 23.62	5.6
CPFP5255	525 20.67	561 22.10	525 x 550 20.67 x 21.65	5.6
CPFP5560	555 21.85	611 24.06	555 x 600 21.85 x 23.62	6.5

SUPPORT BRACKET

Support Bracket provides extra rigidity in 180-mm-deep enclosures that are either pendant- or pedestal-mounted. The bracket mounts in the top or bottom of the enclosure; drilling is required (drill points included on enclosure). The support bracket is not required for 120-mm-deep enclosures.

BULLETIN: C2

Catalog Number	Description	Product Weight (lb.)
CSB180	One bracket per package	1.8

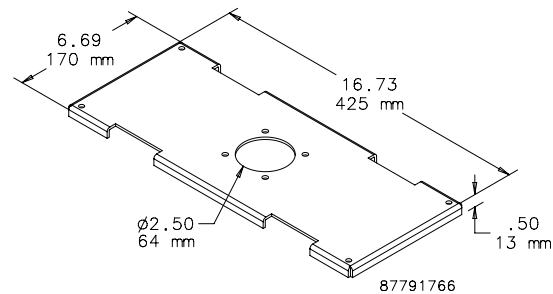

87791766

GROUNDING KIT

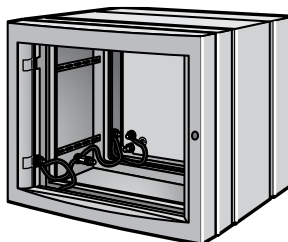

Kit provides a means of attaching a grounding conductor to an enclosure. Kit consists of two insulated copper wires with all installation hardware and instructions included.

BULLETIN: C2

Catalog Number
CCGK

DOOR PANELS



Use Concept HMI Door Panels for mounting in the rear door of a Concept HMI enclosure. Constructed of 14 gauge steel and painted white; conductive panels have a galvanized finish.

BULLETIN: C2

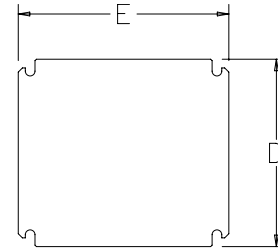

87923202

Catalog Number	Type	Gauge	D (mm)	D (in.)	E (mm)	E (in.)
CP2535	Steel	14	131	5.18	232	9.14
CP2535G	Conductive	12	131	5.18	232	9.14
CP3040	Steel	14	181	7.15	282	11.11
CP3040G	Conductive	12	181	7.15	282	11.11
CP3235	Steel	14	206	8.13	232	9.14
CP3235G	Conductive	12	206	8.13	232	9.14
CP3545	Steel	14	232	9.12	332	13.08
CP3545G	Conductive	12	232	9.12	332	13.08
CP3740	Steel	14	256	10.10	282	11.11
CP3740G	Conductive	12	256	10.10	282	11.11
CP4050	Steel	12	281	11.09	382	15.04
CP4050G	Conductive	12	281	11.09	382	15.04
CP4245	Steel	12	306	12.07	332	13.08
CP4245G	Conductive	12	306	12.07	332	13.08
CP4555	Steel	12	331	13.05	432	17.01
CP4555G	Conductive	12	331	13.05	432	17.01
CP4750	Steel	12	356	14.04	382	15.04
CP4750G	Conductive	12	356	14.04	382	15.04
CP4860	Steel	12	361	14.23	482	18.98
CP4860G	Conductive	12	361	14.23	482	18.98
CP5255	Steel	12	407	16.01	432	17.01
CP5255G	Conductive	12	407	16.01	432	17.01
CP5560	Steel	12	436	17.19	482	18.98
CP5560G	Conductive	12	436	17.19	482	18.98

Notes