

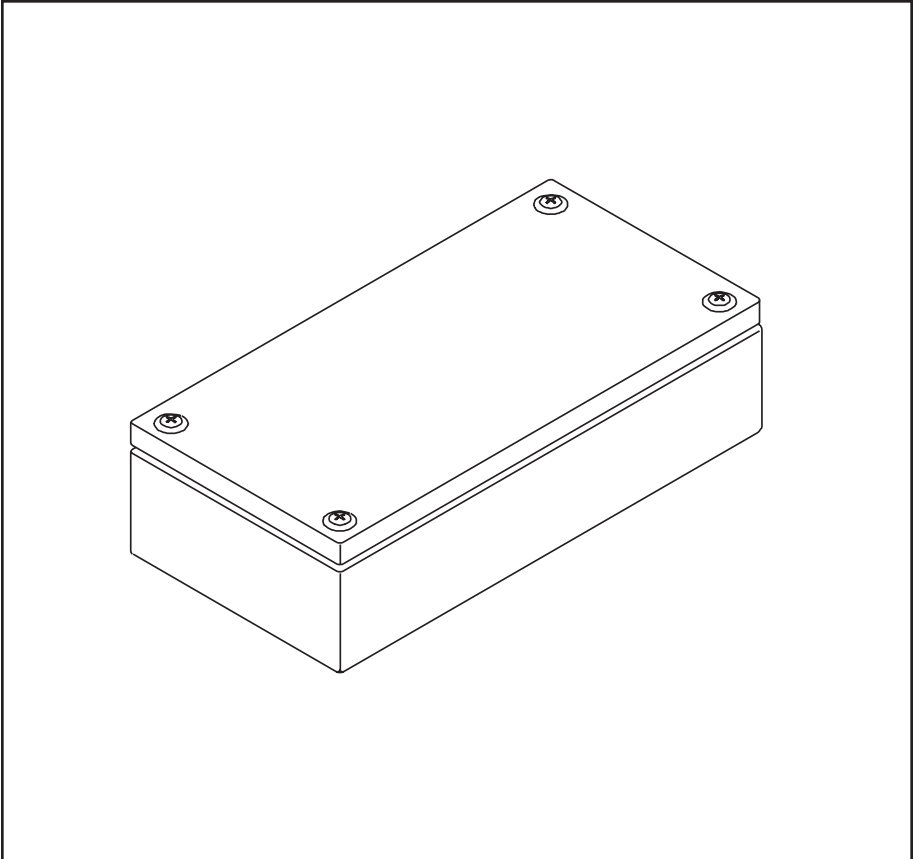







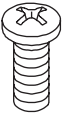

INLINE



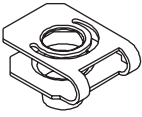

<p>1</p>  <p>(4x)</p>	<p>2</p>  <p>(4x)</p>	<p>3</p>  <p>(0x)</p>
<p>4</p>  <p>(4x)</p>	<p>5</p>  <p>(4x)</p>	<p>6</p>  <p>(2x)</p>
<p>7</p>  <p>(2x)</p>	<p>8</p> <p>M5x8</p>  <p>(6x)</p>	<p>9</p>  <p>(4x)</p>

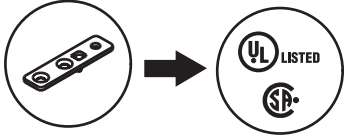
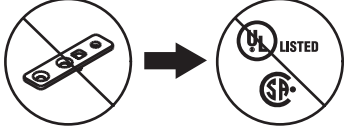

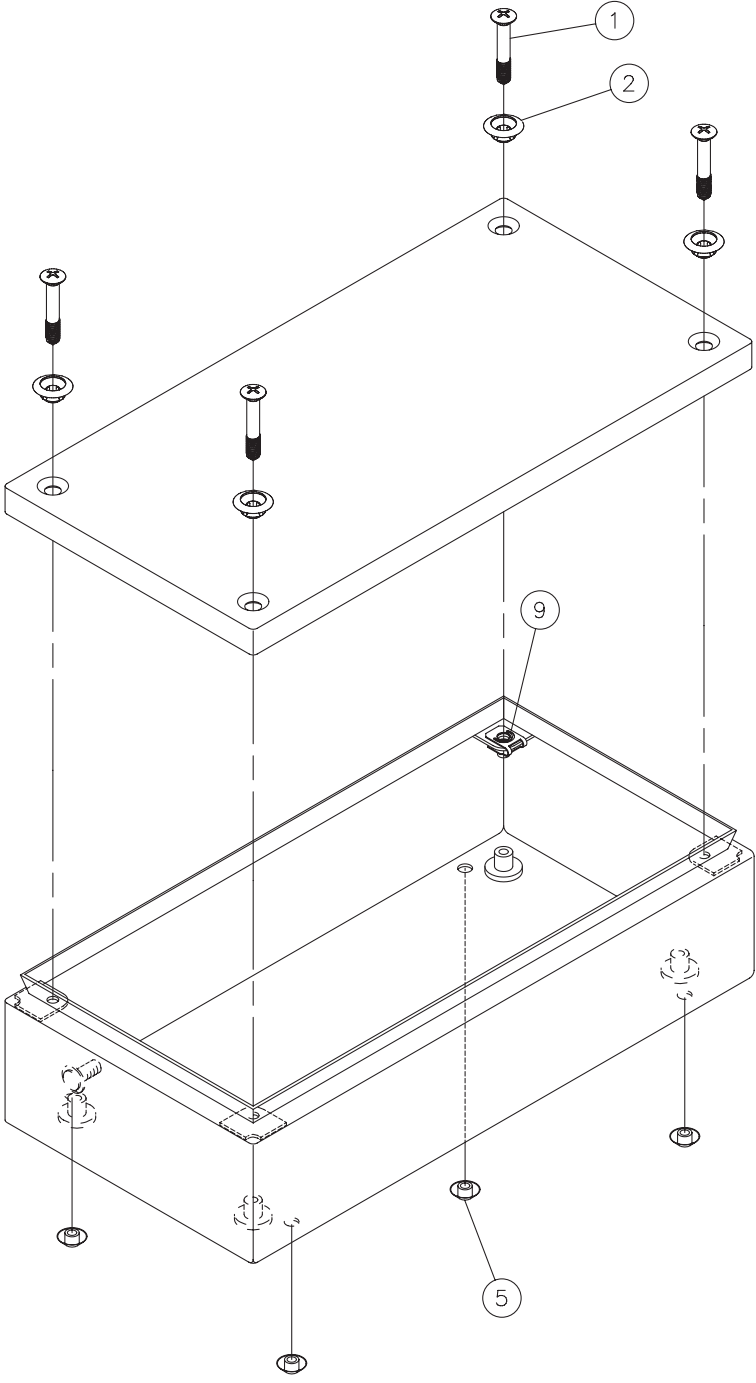

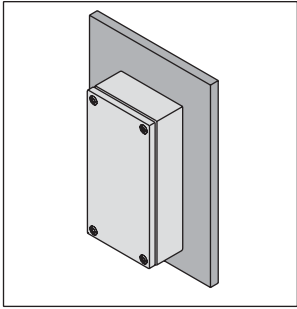



LMFK
LMFKSS

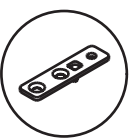









 → 

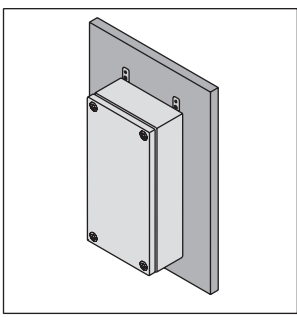
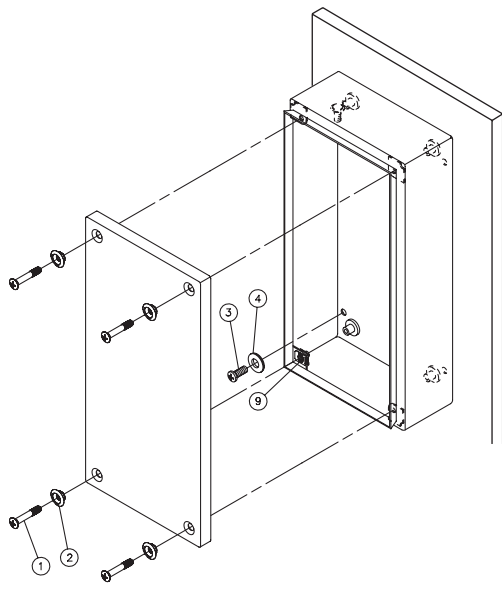

 → 

LMFK
LMFKSS

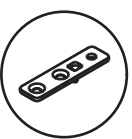



 → 

 → 

LMFK
LMFKSS

