

Angle and Offset Bracket Supports

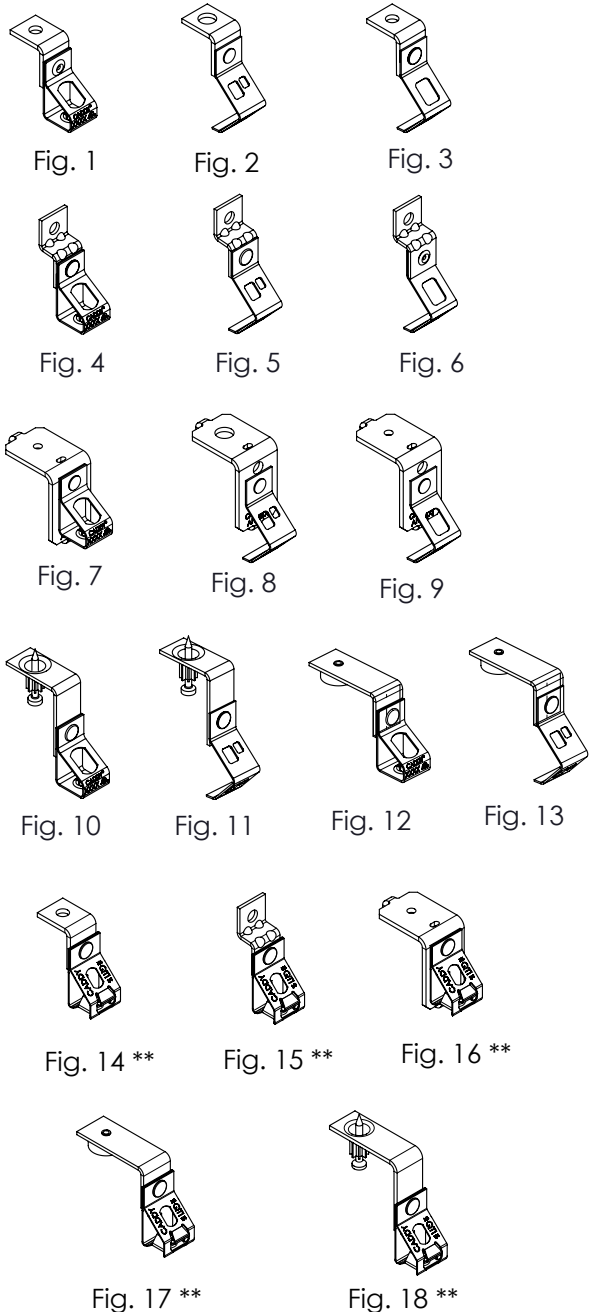

SIZING CHART

Angle Bracket		Offset Bracket		Attachment (in. [mm])	Rod Size (in. [mm])	F (lbs. [N])
Part Number	Fig.	Part Number	Fig.			
4TIB	1	4TIO		1/4 [6]	1/4" Threaded Rod	160 [700]
6TIB	1	6TIO	4		3/8" Threaded Rod	
6TB	1	6TO			* Plain Hole For 3/8" [M10] Threaded Rod	
708AB	2	708AO	5		#8 Wire or 1/4" Plain Rod	
6AB	3	6AO	6		3/8" Plain Rod	
Angle Bracket						
Part Number	Article Number	Fig.				
M6TIB	174850	1	1/4 [6]	M6 Threaded Rod	160 [700]	
M8TIB	174940			M8 Threaded Rod		
M10TIB	175030			M10 Threaded Rod		
4TIAFAB3		7	3/16"	1/4" Threaded Rod	160 [700]	
6TIAFAB3				3/8" Threaded Rod		
6TAFAB3				* Plain Hole For 3/8" [M10] Threaded Rod		
708AFAB3				#8 Wire or 1/4" Plain Rod		
6AFAB3				3/8" Plain Rod		
4TIBSF	N/A	10	+ Drive Pin	1/4" Threaded Rod	100 [440]	
6TIBSF				3/8" Threaded Rod		
6TBSF				* Plain Hole For 3/8" [M10] Threaded Rod		
6ASF				3/8" Plain Rod		
708SF				#8 Wire or 1/4" Plain Rod		
4TIBGBSF	170906	12	Nozzle Insert	1/4" Threaded Rod	75 [330]	
6TIBGBSF				3/8" Threaded Rod		
M8TIBGBSF				M8 Threaded Rod		
M10TIBGBSF	170916			M10 Threaded Rod		
708GBSF	N/A	13		#8 Wire or 1/4" Plain Rod		
4QTIB		14	1/4 [6]	1/4" or M6 Threaded Rod ** Push To Install	75 [330]	
4QTIO		15				
4QTIAFAB3		16	3/16"			
4QTIGBSF	170896	17	Nozzle Insert			
4QTIBSF	N/A	18	+ Drive Pin			

Portions of All Parts Made From Spring Steel * Nuts Required

+ Uses DeWalt® DFD3374 with pin number 50032. For minimum fastener embedment depths in steel or concrete, please consult www.anchors.dewalt.com Load = 100 lbs.

WARNING:

- nVent products shall be installed and used only as indicated in nVent product instruction sheets and training materials. Instruction sheets are available at www.nVent.com and from your nVent customer service representative.
- nVent products must never be used for a purpose other than the purpose for which they were designed or in a manner that exceeds specified load ratings.
- All instructions must be completely followed to ensure proper and safe installation and performance.
- Improper installation, misuse, misapplication or other failure to completely follow nVent's instructions and warnings may cause product malfunction, property damage, serious bodily injury and/or death, and void your warranty.
- Products that are manufactured using spring steel components shall be used only in a non-corrosive indoor environment.
- All pipe supports, hangers, intermediate components and structural attachments must ONLY be used as described herein and are NEVER to be used for any other purpose.

NOTE: All load ratings are for static conditions and do not account for dynamic loading such as wind, water or seismic loads, unless otherwise noted.

The customer is responsible for:

- Conformance to all governing codes.
- The integrity of structures to which the products are attached, including their capability of safely accepting the loads imposed, as evaluated by a qualified engineer.
- Using appropriate industry standard hardware as noted above.

SAFETY INSTRUCTIONS:

All governing codes and regulations and those required by the job site must be observed. Always use appropriate safety equipment such as eye protection, hard hat, and gloves as appropriate to the application.

nVent, nVent CADDY, nVent ERICO Cadweld, nVent ERICO Critec, nVent ERICO, nVent ERIFLEX, and nVent LENTON are owned by nVent or its global affiliates. All other trademarks are the property of their respective owners. nVent reserves the right to change specifications without prior notice.

TECHNICAL SUPPORT:
www.nVent.com

CFS139_J

1 OF 2

© 1998 - 2020 nVent All Rights Reserved



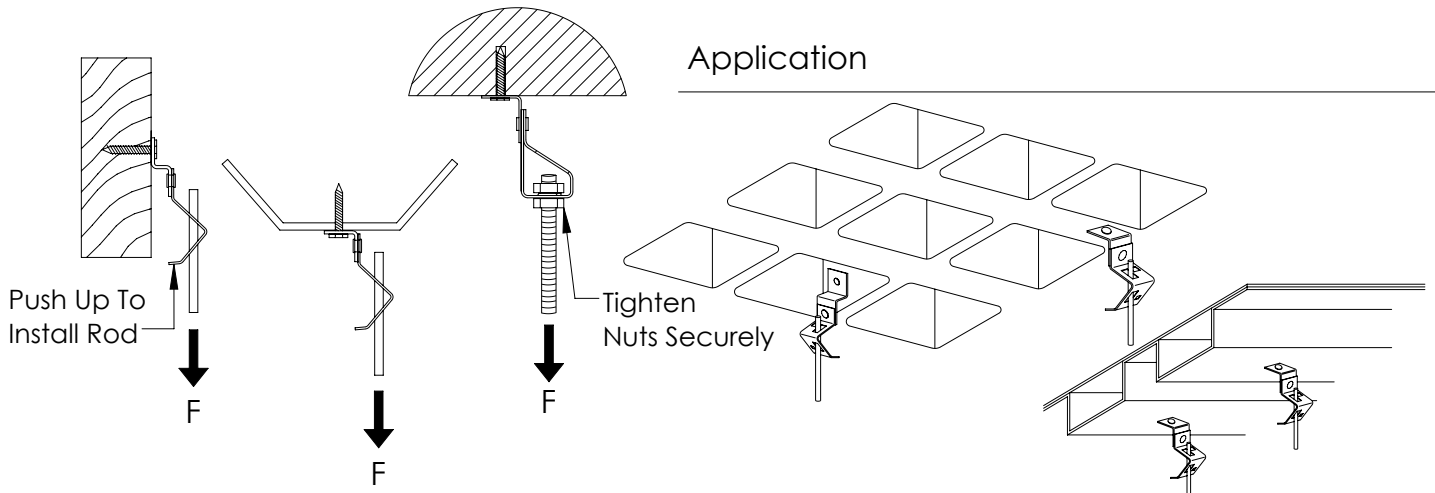

Wood joist or wall -- concrete, etc. Static load limit per sizing chart. Load is for fastener only, attachment method must be evaluated separately.

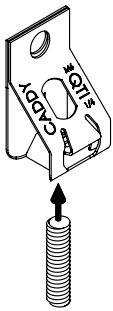

INSTALLATION AND ADJUSTMENT

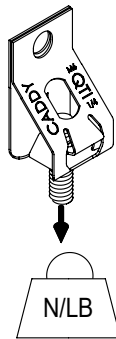

MAX TORQUE
20 in-lb
2.25 Nm

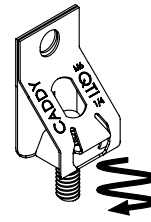

REMOVAL OPTION 1

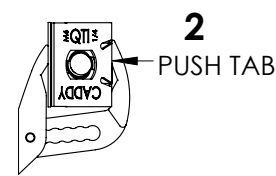
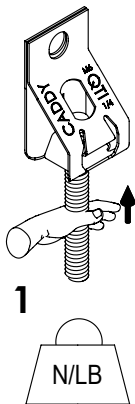

LARGE ADJUSTMENTS OR OPTION 2 REMOVAL

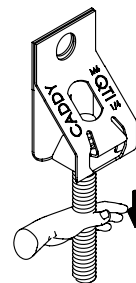
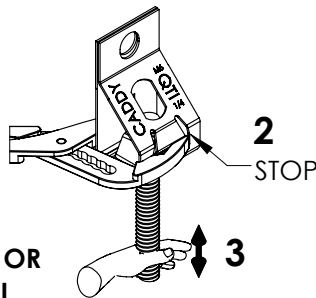

4 CHECK

