

Contents

Application and Description	1-2
Product Offering and Specification Guide	1-3
Product Features and Customer Benefits	1-4
Catalogue Numbering System	1-5
EQL, SNC, & SEQ Single phase Loadcentres	
EQL Loadcentres with main lug only	1-6
SNC Loadcentres with main lug only	1-6
SEQ Service Entrance Loadcentres	1-6
EQL Loadcentres Type 3R	1-7
SEQ Service Entrance Loadcentres Type 3R	1-7
SEQ Dual Listed/cULus Loadcentres	1-8
EQ3 Single phase & EQ4 Three phase Loadcentres	1-9
SPA panel, Mini panels and Enclosed Breaker	1-10
EQG Generator Panels	
EQG 3 Pole	1-11
EQG 2 Pole	1-11
Plug in Branch Breakers Type Q	
Full Module (1" per pole)	1-12
Half Module (1/2" per pole): Twin and Quad Type	1-12
Replacement Main Breakers	1-13
Arc Fault Interrupters	1-14
Ground Fault Interrupters	1-14
Bolt-On Branch Breakers Type BQ	
Full Module (1" per pole)	1-15
Blue Line Breakers	1-15
Accessories and Replacement Parts	1-16 – 1-18
Surge Protection	
Circuit Breaker and Surge Protective Device (SPD)	1-19
Power Service Entrance Surge Protection	1-20
Telephone Service Entrance Surge Protection	1-21
Coaxial Service Entrance Surge Protection	1-21
Knockout Data for Loadcentres	1-22 - 1-23
Line Diagrams/Dimension Drawings for Breakers	1-24
Lug Data	1-24

Loadcentres

Applications and Descriptions

Description

No. Applications	Products
1 Miscellaneous Applications Standard Main Lugs Only Panel	 EQL & SNC Loadcentre-Indoor & Outdoor Type
2 Single Family	SEQ Loadcentre – Indoor & Outdoor Type
3 Duplex Units, Small Apartment Building, Small Professional and Commercial Building (Two to Six Units Maximum)	a) SEQ Service Entrance Equipment – Indoor & Outdoor Type b) EQL Main Lugs Loadcentre – Indoor & Outdoor Type c) SNC Main Lugs Loadcentre - Indoor type
4 Office Building/Condo/Apartment Building (3Ø Application)	a) Switchboards b) Busways c) Modular Metering d) EQ4 Loadcentres Main Lug only or Main Breaker
5 Small Industrial/Commercial Building (3Ø Application)	a) Switchboards b) Busways c) 3Ø Modular Metering d) EQ4 Loadcentres Main Lug Only or Main Circuit Breaker

A loadcentre is a metal enclosed distribution panel containing circuit breakers which distribute, protect and control lighting and power circuits in residential and light commercial applications, including single-family homes, townhouses, apartment buildings, and small office buildings.

All Siemens loadcentres can be classified into two types: main lug or main circuit breaker. Each Siemens loadcentre consists of three basic components: the enclosure, the interior, and the trim. The enclosure is used to contain the circuit breakers which mount on the interior. The trim seals the enclosure, offering protection to personnel from the environment.

A complete line of breakers and accessories which give Siemens loadcentres flexibility. For example, Ground Fault Interrupters protect personnel, an important consideration with the stress placed on personnel protection by the CEC. Handle ties, handle blocking devices, padlocking devices and filler plates are also available. Neutral lug kits in a variety of wire range sizes.



Included into all Loadcentres and Q Breakers

Loadcentres

Product Offering and Specification Guide

Description

Application

Main lug loadcentre

- 1 Phase 3 W 120/240V, 60 to 200A, 2/4 - 40/80 circuits
- 3 Phase 4W 120/208V, 100 to 225A, 12 - 42 circuits
- Outdoor Type 3R, 1 Phase 3 W, 120/240V, 100 to 200A, 8/16 - 40/80 circuits

Main breaker loadcentre

- 1 Phase 3 W 120/240V, 60 to 200A, 12/24 - 60/120 circuits
- 3 Phase 4W 120/208V, 100 to 200A, 24 - 42 circuits
- Outdoor Type 3R, 1 Phase 3 W 120/240V, 100 to 200A, 16/32 - 40/80 circuits
- Dual certified loadcentre 1 Phase 3 W 120/240V, 100 to 200A, 38 circuits

Generator panel

- Generator panel 3 Pole 1 Phase 3 W 120/240V, 30 to 100A, 6/12- 34/68 circuits
- Generator panel 2 Pole 1 Phase 3 W 120/240V, 30 to 100A, 8/16 - 36/72 circuits

SPA panel

- Type 3R, 1Phase 3 W 120/240V, 125A, 4/8 circuits

Mini panel/ Enclosed breaker,

- Indoor, 1Phase 3 W 120/240V, 60 & 125A, 2 circuits
- Outdoor Type 3R, 1 Phase 3 W 120/240V, 60 & 125A, 3 & 2/4 - 4/8 circuits

Circuit breaker

Plug-in

Interrupting rating of 10kA

- Full module
 - 1 Pole 15-70 Amp
 - 2 Pole 15-200 Amp
 - 3 Pole 15-100 Amp
- Half module
 - Twin: two single-pole, 15-15 to 40-15 Amp
 - Quad: two single-pole and one 2-pole inner breaker, 15-15 to 15-40 Amp

Bolt-on

Interrupting rating of 10kA & 22kA

- Full module
 - 1 Pole 15-70 Amp
 - 2 Pole 15-125 Amp
 - 3 Pole 15-100 Amp

Ground fault circuit interrupter

- 1 and 2 Pole, 15- 60A, 5 and 30mA sensitivity

Arc fault circuit interrupter

Interrupting rating of 10kA & 22kA

- 1 Pole, 15 and 20 Amp

Surge arrester breakers

- Two single pole breakers and one surge arrester, 15 and 20 Amp

Surge protection device (SPD)

- Power service entrance surge protection
- Telephone service entrance surge protection
- Coaxial service entrance surge protection

Specification Guide - Loadcentres

Loadcentre enclosures and trims are formed of cold rolled, code gauge steel. All devices are finished with ANSI 61 grey paint (electro deposition painting process).

The combination flush/surface trim is flat and plumb in appearance. The Siemens Type 3R loadcentre features industry exclusive gasketed door for improved weatherproof protection. The enclosures and interiors provide 4^{1/4}" (108 mm) side wiring gutters for branch circuits. Main bus bars are formed of cold rolled, one piece tin plated (acid bath tin, zincate process) aluminum. Copper bus is also available. Main lugs, neutral assemblies, and ground bars are suitable for copper or aluminum conductors and comply with the requirements of CSA. The extended capacity fully distributed neutrals give a neutral termination at every breaker position, and is mounted, along with bus bars, on a base part made of engineered resin. CSA listed for 60/75YC wiring applications; ratings are as follows: loadcentre main terminals 60/75YC cu/al wire; branch breaker terminals-60/75YC cu/al wire. All loadcentres are CSA listed under file #13069.

Individual circuit breakers are thermal magnetic, quick-make quick-break, trip free, plug-in construction. All two and three pole breakers are common trip. All circuit breakers are CSA listed under file #14374.

*Series rating labels on all loadcentres.



Loadcentres

Product Features and Customer Benefits

1

LOADCENTRES

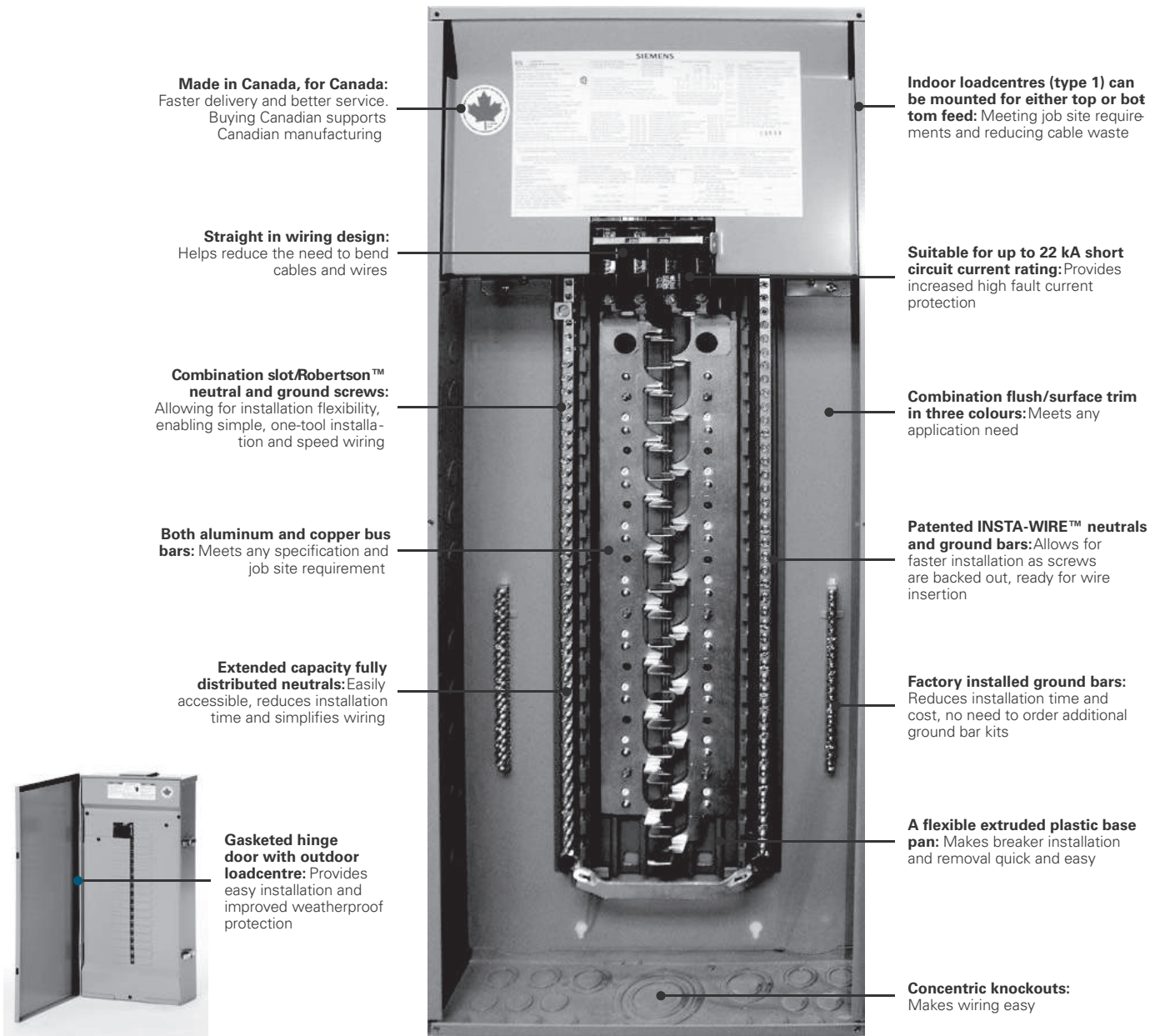

Features and Benefits

Siemens provides the broadest product portfolio related to single and multifamily applications. Flexibility, innovation and quality are the hallmarks of Siemens products for single and multi-family applications providing the customer with unmatched value. One example is our quick-make quick-break circuit breakers which give homeowners peace of mind and fast acting circuit protection. Our whole house surge protection solutions, arc fault and ground fault circuit interrupters provide additional protection against the risks of electrocution, fire hazard and property damage. With the comprehensive selection of options and accessories, Siemens loadcentres and breakers are the smart choice for the conscientious customer.

Loadcentres

Catalogue Numbering System

Catalogue Numbering System^①

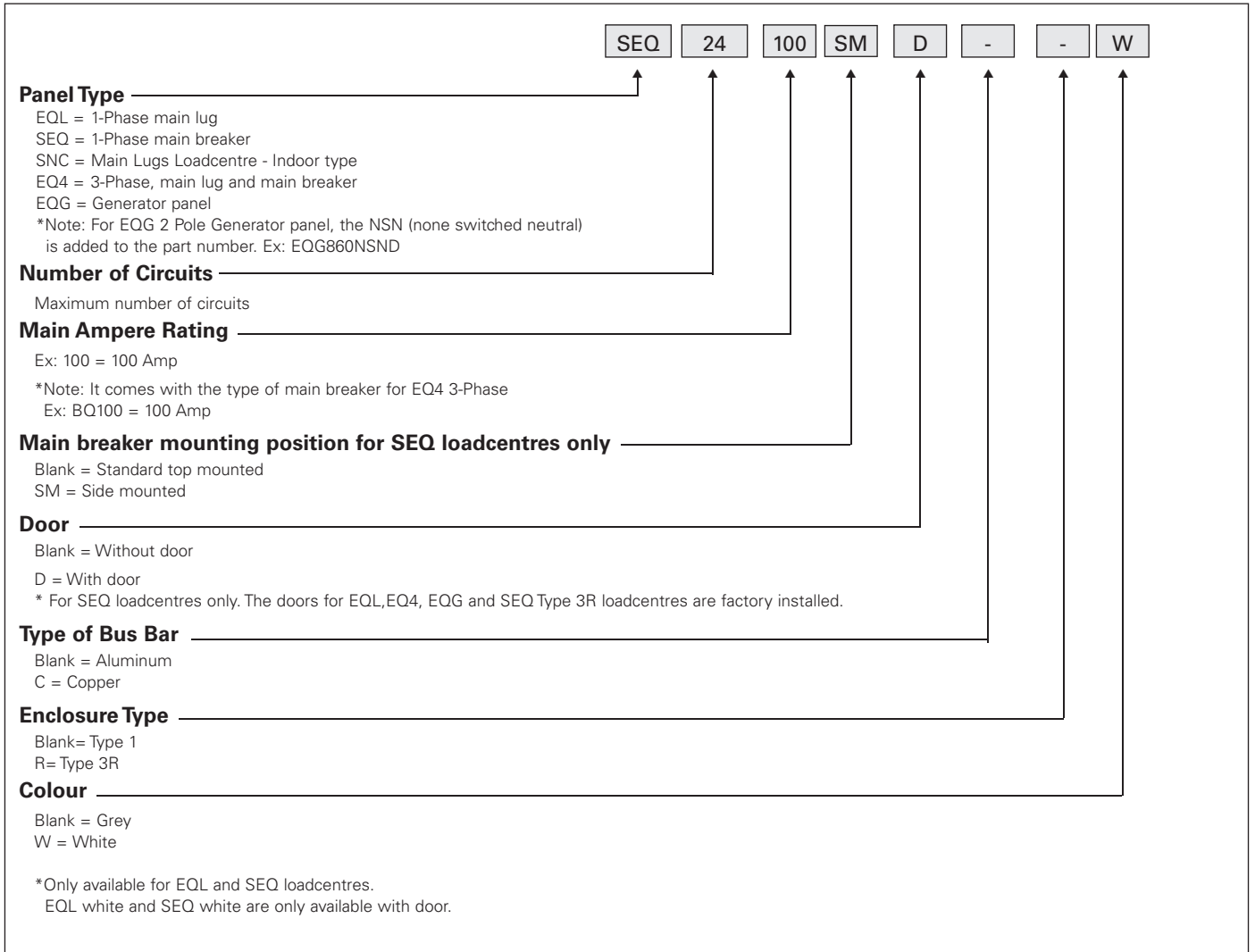

^① The Catalogue numbering system applies only to EQL, EQL Type 3R, SEQ, SEQ Type 3R, EQ4 and EQG loadcentres.

Loadcentres

EQL & SEQ Single Phase Main Lug & Main Breaker Loadcentres

Selection
INSTA WIRE™

Selection and Ordering Data

LOADCENTRES

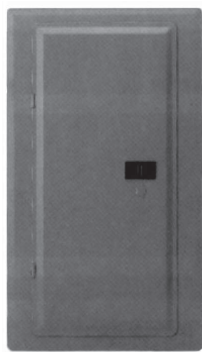

EQL24125D



SEQ40200

EQL Loadcentres with main lugs only 1 phase 3 wire 240 V AC max.

Number of Circuits	Catalogue Number	Skid Qty.	Main Amps	Dimensions - Inches (mm)			Lug Data	Mounting Trim	Door Kit Catalogue Number	Factory Mod.
				H	W	D				
2/4	EQL260S	330	60	7 (178)	5 (127)	2 ³ / ₄ (70)	3	surface	N/A	N/A
4/8	EQL4100	90	100	12 ⁵ / ₈ (322)	6 ⁵ / ₈ (168)	3 ¹ / ₂ (90)	1	comb.	N/A	N/A
8/16	EQL8100D*	72	100	14 ⁷ / ₈ (378)	12 (305)	3 ³ / ₄ (95)	4-2/0	comb.	DK8-A	N/A
12/24	EQL12125D [Ⓢ]	45	125	16 ⁷ / ₈ (429)	12 (305)	3 ³ / ₄ (95)	4-2/0	comb.	DK12-A	①
16/32	EQL16125D [Ⓢ]	45	125	18 ⁷ / ₈ (479)	12 (305)	3 ³ / ₄ (95)	4-2/0	comb.	DK16-A	①
24/48	EQL24125D [Ⓢ]	36	125	24 ¹ / ₈ (613)	13 ¹ / ₂ (331)	3 ³ / ₄ (95)	4-2/0	comb.	DK24-A	①
32/64	EQL32200D [Ⓢ]	27	200	33 (838)	14 ¹ / ₄ (362)	4 (102)	6-250 MCM	comb.	DKL32-2A	①
40/80	EQL40200D [Ⓢ]	27	200	33 (838)	14 ¹ / ₄ (362)	4 (102)	6-250 MCM	comb.	DKL40-2A	①

Note: EQL8100D through EQL40200D[Ⓢ] are stocked complete with doors *Neutral bar only on one side of panel.

12/24	SNC1224L1125 [Ⓢ]	28	125	18	14 ¹ / ₄	3 ⁷ / ₈	2/0	comb.	RSCT1224L1125	N/A
16/32	SNC1632L1125 [Ⓢ]	28	125	21	14 ¹ / ₄	3 ⁷ / ₈	2/0	comb.	RSCT1632L1125	N/A
24/48	SNC2448L1125 [Ⓢ]	28	125	24	14 ¹ / ₄	3 ⁷ / ₈	2/0	comb.	RSCT2448L1125	N/A
30/48	SNC3048L1200 [Ⓢ]	21	200	30	14 ¹ / ₄	3 ⁷ / ₈	300 kcmil	comb.	RSCT3048L1200	N/A
40/60	SNC4060L1200 [Ⓢ]	21	200	36	14 ¹ / ₄	3 ⁷ / ₈	300 kcmil	comb.	RSCT4060L1200	N/A

Service Entrance Loadcentres with Factory installed main breaker 1 phase 3 wire 240 V AC max.

12/24	SEQ12060SM	54	60	17 ⁵ / ₈ (448)	13 ¹ / ₈ (333)	3 ³ / ₄ (95)	6-2/0	comb.	DK1216SM-1	①
16/32	SEQ16060SM [Ⓢ]	36	60	19 ⁵ / ₈ (498)	13 ¹ / ₈ (333)	3 ³ / ₄ (95)	6-2/0	comb.	DK1216SM-1	①
24/48	SEQ24060SM [Ⓢ]	36	60	24 ¹ / ₈ (613)	13 ¹ / ₈ (333)	3 ³ / ₄ (95)	6-2/0	comb.	DK24SM-1	①
12/24	SEQ12100SM	54	100	17 ¹ / ₂ (444)	13 ¹ / ₈ (333)	3 ³ / ₄ (95)	4-2/0	comb.	DK1216SM-1	①
16/32	SEQ16100SM	36	100	17 ¹ / ₂ (444)	13 ¹ / ₈ (333)	3 ³ / ₄ (95)	4-2/0	comb.	DK1216SM-1	①
24/48	SEQ24100SM [Ⓢ]	36	100	24 ¹ / ₈ (613)	13 ¹ / ₈ (333)	3 ³ / ₄ (95)	4-2/0	comb.	DK24SM-1	①
24/48	SEQ24100SMK [■]	36	100	24 ¹ / ₈ (613)	13 ¹ / ₈ (333)	3 ³ / ₄ (95)	4-2/0	comb.	DK24SM-1	①
24/48	SEQ24125SM [Ⓢ]	36	125	24 ¹ / ₈ (613)	13 ¹ / ₈ (333)	3 ³ / ₄ (95)	4-2/0	comb.	DK24SM-1	①
24/48	SEQ24150 [Ⓢ]	27	150	27 (686)	14 ¹ / ₄ (362)	4 (102)	6-250 MCM	comb.	DKS24-2A	①
24/48	SEQ24200 [Ⓢ]	27	200	27 (686)	14 ¹ / ₄ (362)	4 (102)	6-250 MCM	comb.	DKS24-2A	①
32/64	SEQ32100SM	27	100	27 ¹ / ₈ (689)	13 ¹ / ₈ (333)	3 ³ / ₄ (95)	4-2/0	comb.	DK32SM-1	①
32/64	SEQ32125SM	27	125	27 ¹ / ₈ (689)	13 ¹ / ₈ (333)	3 ³ / ₄ (95)	4-2/0	comb.	DK32SM-1	①
32/64	SEQ32150	27	150	33 (838)	14 ¹ / ₄ (362)	4 (102)	6-250 MCM	comb.	DKS32-2A	①
32/64	SEQ32200	27	200	33 (838)	14 ¹ / ₄ (362)	4 (102)	6-250 MCM	comb.	DKS32-2A	①
40/80	SEQ40100	27	100	36 (914)	14 ¹ / ₄ (362)	4 (102)	6-250 MCM	comb.	DKS40-1A	①
40/80	SEQ40125	27	125	36 (914)	14 ¹ / ₄ (362)	4 (102)	6-250 MCM	comb.	DKS40-1A	①
40/80	SEQ40150	27	150	36 (914)	14 ¹ / ₄ (362)	4 (102)	6-250 MCM	comb.	DKS40-2A	①
40/80	SEQ40200 [Ⓢ]	27	200	36 (914)	14 ¹ / ₄ (362)	4 (102)	6-250 MCM	comb.	DKS40-2A	①
60/120	SEQ60200	18	200	46 (1168)	14 ¹ / ₄ (362)	4 (102)	6-250 MCM	comb.	N/A	N/A

[■] Standard SEQ24100SMK with additional knockouts to bottom plate

Note: Comb= Combination Flush/Surface mounted Certified for use with any combination of full or half module plug-in circuit breakers. Certified for mounting vertical, horizontal or inverted and for use with CU/AL conductors including compact stranded. All neutral bar connectors are No. 14 - No.4.

Typical circuit rating (ie. 24/48) indicates the circuit capacity of the loadcentre is 24 full module (1") breaker of 48 half-module (1/2") breakers.

① Factory modification, see next page.
Ⓢ For copper bus add suffix C to existing part number. 4 weeks delivery required.

Ⓢ EQL and SNC available in White paint colour. Add "W" to end of part number.



Loadcentres

EQL, SNC, & SEQ Single Phase Main Lug & Main Breaker Loadcentres

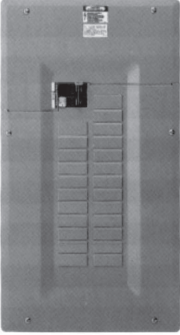

Selection and Ordering Data

1
LOADCENTRES

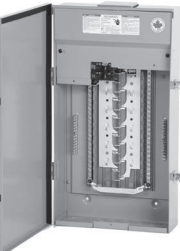
 <p>SEQ24125SM</p>	Factory Modifications[®]											
	Type	Description	Catalogue Number			Example			Delivery			
	EQL	White door and trim	add suffix... W			EQL24125DW			2 weeks			
	SNC	White door and trim	add suffix... W			SNC1224L1112SW						
	SEQ	Grey door installed White door and trim	add suffix... D add suffix... DW			SEQ24125SMD SEQ24125SMDW						
	Door Kit	White Door kit	add suffix... W			DK24SM-1W						
Note: All door kits are available in Grey and White colours.												
EQL	Copper Bus	add suffix... CR			EQL24125DCR			4 weeks				
Weatherproof Loadcentre Main Lug Only, 1 phase 3 wire 120/240V AC max.												
 <p>EQL24125DCR</p>	Number of Circuits	Catalogue Number	Skid Qty.	Main Amps	Dimensions - Inches (mm)			Lug Data	Mounting Trim	Factory Mod.	Hubs (sold separately)	
					H	W	D				Conduit size (")	Catalogue Number
	12/24	EQL12125DCR	35	125	19 ⁷ / ₈ (505)	13 ³ / ₄ (349)	5 (127)	6-2/0	surface only	N/A	3/4 1	ECHS075 ECHS100
	24/48	EQL24125DCR	28	125	24 ⁷ / ₈ (632)	13 ³ / ₄ (349)	5 (127)	6-2/0	surface only	N/A	1 1/4 1 1/2	ECHS125 ECHS150
	40/80	EQL40200DCR	21	200	33 ⁵ / ₈ (853)	15 (381)	5 (127)	6-250 MCM	surface only	N/A	2 2 1/2	ECHS200 ECHS250
* Neutral bar only on one side of panel.												
SEQ Type 3R Weatherproof Loadcentre with Factory installed main breaker 1 phase 3 wire 240V AC max.												
 <p>SEQ24100SMCR</p>	Number of Circuits	Catalogue Number	Skid Qty.	Main Amps	Dimensions - Inches (mm)			Lug Data	Mounting Trim	Factory Mod.	Hubs (sold separately)	
					H	W	D				Conduit size (")	Catalogue Number
	16/32	SEQ16100SMCR	35	100	21 ⁵ / ₈ (549)	13 ⁹ / ₁₆ (345)	5 (127)	6-2/0	surface only	N/A	3/4 1	ECHS075 ECHS100
	24/48	SEQ24100SMCR	28	100	24 ⁵ / ₈ (625)	13 ⁹ / ₁₆ (345)	5 (127)	6-2/0	surface only	N/A	1 1/4 1 1/2	ECHS125 ECHS150
	24/48	SEQ24200CR	21	200	27 ¹ / ₂ (699)	15 (381)	5 (127)	6-250 MCM	surface only	N/A	2 2 1/2	ECHS200 ECHS250
40/80	SEQ40200CR	21	200	36 ¹ / ₂ (927)	15 (381)	5 (127)	6-250 MCM	surface only	N/A			
Note: Both SEQ and EQL weatherproof panels are stocked complete with gasketed hinged door for improved weatherproof protection. All SEQ and EQL Type 3R panels come standard with copper bus.												

Loadcentres

EQL, SNC, & SEQ Single Phase Main Lug & Main Breaker Loadcentres (continued)

Selection

Selection and Ordering Data

LOADCENTRES

Dual Listed/cULus Loadcentres 120/240V 1 phase 3 Wire									
Number of Circuits	Catalogue Number	Skid Qty.	Main Amps	Dimensions - Inches (mm)			Lug Data	Mounting Trim	Door Kit Catalogue Number
				H	W	D			
38	SEQ38100U	27	100	36 (362)	14 ¹ / ₄ (362)	4 (102)	6-250MCM	comb.	DKS38-1A
	SEQ38125U	27	125						DKS38-2A
	SEQ38150U	27	150						
	SEQ38200U	27	200						
<p>Branch breakers: Only 1" full module breakers that are both UL & CSA certified are allowed to be installed in this loadcentre; 1/2" twin and quad branch breakers must not be used as per NEC 384-14(a) and NEC-384-15. Consult Siemens Sales Rep. for details.</p> <p>Application benefit: Allows modular home builders who have businesses in both US & Canada to carry only one line of inventory.</p>									



SEQ38200U

Loadcentres

EQ3 Single Phase & EQ4 Three Phase Loadcentres

Selection

Selection and Ordering Data

1
LOADCENTRES

EQ3 Single Phase Loadcentres									
With Main Lugs only 1 phase 3 Wire 120/240 V AC max. 10KA									
Number of Circuits	Catalogue Number	Main Amps	Dimensions - Inches (mm)			Lug Data	Mounting Trim	Door Catalogue Number	Factory Mod.
			H	W	D				
24	EQ324225	225	34 (864)	14 ³ / ₈ (365)	4 ³ / ₈ (111)	6-300 MCM	comb.	DKEQ2430	①
40	EQ340225	225	40 (1016)					DKEQ42	
EQ3 Service Entrance Loadcentre									
With factory Installed Main Breaker 1 phase 3 Wire 120/240 V AC max. 10KA									
24	EQ324BQ125	125	34 (864)	14 ³ / ₈ (365)	4 ³ / ₈ (111)	#6 - 2/0	comb.	DKEQ24BQ	①
32	EQ332BQ125	125	40 (1016)					DKEQ42	
EQ Three Phase Loadcentres ^①									
With main lugs only 3 phase 4 wire 240V AC max. 10 KA									
12	EQ412100	100	28 (711)	14 ³ / ₈ (365)	4 ³ / ₈ (111)	14-2/0	comb.	DKEQ1218	①
18	EQ418100	100	28 (711)					DKEQ1218	
24	EQ424225	225	34 (864)			6-300 MCM		DKEQ2430	
30	EQ430225	225	34 (864)					DKEQ2430	
42	EQ442225	225	40 (1016)					DKEQ42	
Service Entrance Loadcentres									
With factory installed main breaker 3 phase 4 wire 240 V AC max. 10 KA.									
24	EQ424BQ100	100(BQ)	34 (864)	14 ³ / ₈ (365)	4 ³ / ₈ (111)	4-2/0	comb.	DKEQ24BQ	①
42	EQ442QR100	100(QR)	46 (1168)					6-300 MCM	
42	EQ442QR125	125(QR)	46 (1168)			DKEQ42QR			
42	EQ442QR150	150(QR)	46 (1168)			DKEQ42QR			
42	EQ442QR200	200(QR)	46 (1168)			DKEQ42QR			
Factory Modifications ^①									
Type	Description	Catalogue Number	Example			Delivery			
EQ4	Copper Bus	add suffix...C	EQ430225C			4 Weeks			
Lug Kits For EQ Loadcentres									
Catalogue Number	Loadcentre Amps Rating		Description						
SFK100	100		Sub-feed Kit 14-2/0 (Per Phase)						
SFK225	225		Sub-feed Kit 1/0-250 MCM (Per Phase)						
TFK100	100		Through-feed Kit 14-2/0 (Per Phase)						
TFK225	225		Through-feed Kit 6-300 MCM (Per Phase)						



EQ424BQ100



SFK225



TFK100

Note : Certified for use with either plug-in (Type Q) or bolt-on (Type BQ) branch breakers. Number of circuits can be doubled by use of plug-in (Type QT) twin breakers. Certified for mounting vertical, horizontal or inverted and for use with CU/AL conductor including compact stranded. All neutral bar connectors are No. 14 - No. 4.

①All Three Phase EQ loadcentres are stocked complete with doors. Interior only is not available. Must be ordered as a complete unit.

Note: For copper bus add suffix C to existing part number. 4 weeks delivery required





Loadcentres

SPA panel and Mini Panel/Enclosed Breaker

Selection
INSTA WIRE™

Selection and Ordering Data

LOADCENTRES

 W0408ML1125  2-POLE GFCI	SPA panel package, 3R enclosure 120/240V 1 Phase 3 Wire																																							
	Number of Circuits	Package Catalogue Number	Main Amps.	GFCI Included	Enclosure Dimensions - Inches (mm)			Hubs (sold seperately)																																
					H	W	D	Conduit Size (")	Catalogue Number																															
	4/8	W0408ML1125-20	125	QF220A	12 1/4 (312)	6 (153)	4 1/4 (108)	Cover 3/4 1 1 1/4 1 1/2 2 2 1/2	ECHS000 ECHS075 ECHS100 ECHS125 ECHS150 ECHS200 ECHS250																															
		W0408ML1125-30		QF230A																																				
		W0408ML1125-40		QF240A																																				
W0408ML1125-50		QF250A																																						
W0408ML1125-60		QF260A																																						
Each package also includes a 4-point ground bar and French instructions.																																								
 EQS260	Circuit Breaker Enclosures for Service Entrance and Commercial Use																																							
	EEMAC 1 Enclosure (Indoor) 1 phase 3 wire 240V AC Max.																																							
	Breaker Range	Catalogue Number	Main Amps.	Number of Poles	Dimensions - Inches (mm)			Lug Data																																
					H	W	D																																	
	15-60A	EQS260* ^①	60	1,2	7 3/4 (197)	5 (127)	2 3/4	14-4 (70)																																
15-125A	EQS2125* ^①	125	1,2	13 (330)	6 5/8 (168)	3 3/8	14-2/0 (86)																																	
*Does not accept quad type breaker.																																								
 WEQ60-4  W0816ML1125CU	EEMAC 3R Weatherproof Enclosure, 1 phase 3 wire 240V AC Max.																																							
	Full Module Circuits	Catalogue Number	Main Amps.	Dimensions - Inches (mm)			Weight lbs.	Hub ^② Type																																
				H	W	D																																		
	3	WEQ60-4 ^③	60	10 1/4 (260)	9 1/2 (241)	5 5/8 (143)	8	HR																																
	2/4	W0204ML1060 ^③	60	8 (204)	5 (127)	4 1/4 (108)	4	HA																																
4/8	W0408ML1125 ^③	125	12 1/4 (312)	6 (153)	4 1/4 (108)	7	HS																																	
8/16	W0816ML1125CU ^③	125	14 3/4 (375)	12 1/8 (308)	4 1/4 (108)	7	HS																																	
Note: Package does not include a 4-point ground bar, please order: GBK4																																								
Key Features: Outdoor EEMAC 3R enclosure • Accepts plug-in Q type breakers • One piece bus bar construction • Combination trim flush/surface				Hubs <table border="1"> <thead> <tr> <th>Catalogue Number</th> <th>Conduit size (")</th> <th>Catalogue Number</th> <th>Conduit size (")</th> </tr> </thead> <tbody> <tr> <td>ECHA075</td> <td>3/4</td> <td>ECHS075</td> <td>3/4</td> </tr> <tr> <td>ECHA100</td> <td>1</td> <td>ECHS100</td> <td>1</td> </tr> <tr> <td>ECHA125</td> <td>1 1/4</td> <td>ECHS125</td> <td>1 1/4</td> </tr> <tr> <td>ECHR075</td> <td>3/4</td> <td>ECHS150</td> <td>1 1/2</td> </tr> <tr> <td>ECHR100</td> <td>1</td> <td>ECHS200</td> <td>2</td> </tr> <tr> <td>ECHR125</td> <td>1 1/4</td> <td>ECHS250</td> <td>2.5</td> </tr> <tr> <td>ECHR150</td> <td>1 1/2</td> <td></td> <td></td> </tr> </tbody> </table>					Catalogue Number	Conduit size (")	Catalogue Number	Conduit size (")	ECHA075	3/4	ECHS075	3/4	ECHA100	1	ECHS100	1	ECHA125	1 1/4	ECHS125	1 1/4	ECHR075	3/4	ECHS150	1 1/2	ECHR100	1	ECHS200	2	ECHR125	1 1/4	ECHS250	2.5	ECHR150	1 1/2		
Catalogue Number	Conduit size (")	Catalogue Number	Conduit size (")																																					
ECHA075	3/4	ECHS075	3/4																																					
ECHA100	1	ECHS100	1																																					
ECHA125	1 1/4	ECHS125	1 1/4																																					
ECHR075	3/4	ECHS150	1 1/2																																					
ECHR100	1	ECHS200	2																																					
ECHR125	1 1/4	ECHS250	2.5																																					
ECHR150	1 1/2																																							
Remark: ① The panels will not accommodate a 2 pole ground fault breaker (GFCI) or breaker with shunt trip. ② Hubs sold seperately ③ Not to be used as service entrance.																																								

Loadcentres

Generator panel

Selection

Selection and Ordering Data

1

LOADCENTRES

Generator Panel, 3 Pole 1 phase 3 wire 240V AC Max. Suitable for use with a generator having a bonded neutral conductor.								
Number of Circuits	Catalogue Number	Skid Qty.	Main Amps	Dimensions - Inches (mm)			Lug Data	Mounting Trim
				H	W	D		
6/12	EQG630D	63	30	16 ^{7/8} (429)	12 (305)	3 ^{3/4} (95)	14-6	Comb.
	EQG660D		60				6-2/0	
	EQG680D		80				6-2/0	
	EQG6100D		100				6-2/0	
10/20	EQG1030D	45	30	18 ^{7/8} (479)	12 (305)	3 ^{3/4} (95)	14-6	Comb.
	EQG1060D		60				6-2/0	
	EQG1080D		80				6-2/0	
	EQG10100D		100				6-2/0	
18/36	EQG1830D	36	30	24 ^{1/8} (613)	13 ^{1/32} (331)	3 ^{3/4} (95)	14-6	Comb.
	EQG1860D		60				6-2/0	
	EQG1880D		80				6-2/0	
	EQG18100D		100				6-2/0	
26/52	EQG2630D	27	30	33 (838)	14 ^{1/4} (362)	4 (102)	14-6	Comb.
	EQG2660D		60				6-2/0	
	EQG2680D		80				6-2/0	
	EQG26100D		100				6-2/0	
34/68	EQG3430D	27	30	33 (838)	14 ^{1/4} (362)	4 (102)	14-6	Comb.
	EQG3460D		60				6-2/0	
	EQG3480D		80				6-2/0	
	EQG34100D		100				8-2/0	
Generator Panel, 2 Pole 1 phase 3 wire 240V AC Max. Suitable for use with a generator having an unbonded neutral conductor.								
8/16	EQG830NSND	63	30	16 ^{7/8} (429)	12 (305)	3 ^{3/4} (95)	14-8	Comb.
	EQG860NSND		60				6-2/0	
	EQG880NSND		80				6-2/0	
	EQG8100NSND		100				6-2/0	
12/24	EQG1230NSND	45	30	18 ^{7/8} (479)	12 (305)	3 ^{3/4} (95)	14-8	Comb.
	EQG1260NSND		60				6-2/0	
	EQG1280NSND		80				6-2/0	
	EQG12100NSND		100				6-2/0	
20/40	EQG2030NSND	36	30	24 ^{1/8} (613)	13 ^{1/32} (331)	3 ^{3/4} (95)	14-8	Comb.
	EQG2060NSND		60				6-2/0	
	EQG2080NSND		80				6-2/0	
	EQG20100NSND		100				6-2/0	
28/56	EQG2830NSND	27	30	33 (838)	14 ^{1/4} (362)	4 (102)	14-8	Comb.
	EQG2860NSND		60				6-2/0	
	EQG2880NSND		80				6-2/0	
	EQG28100NSND		100				6-2/0	
36/72	EQG3630NSND	27	30	33 (838)	14 ^{1/4} (362)	4 (102)	14-8	Comb.
	EQG3660NSND		60				6-2/0	
	EQG3680NSND		80				6-2/0	
	EQG36100NSND		100				6-2/0	
<p>Note: The EQG panels are stocked complete with doors</p> <p>Key Features:</p> <ul style="list-style-type: none"> • Ensures reliable and continuous operation, allows customers to permanently connect critical loads to back up generators in cases of main power failures • Factory ready for use in both switched and non-switched neutral applications • Additional number of generator circuits for more flexibility 								



EQG630D



EQG860NSND

Circuit Breakers

Type Q Plug-In Breakers

Selection and Ordering Data

Selection
INSTA WIRE™

LOADCENTRES

Full Module (1" per pole) 10,000 A.I.C			
Ampere Rating		Catalogue Number	Standard Package
Single Pole			
	15 20 25 30 40 50 60 70	Q115 [Ⓞ] Q120 [Ⓞ] Q125 Q130 Q140 Q150 Q160 Q170	48
Two Pole Common Trip			
	15 20 25 30 35 40 50 60	Q215 Q220 Q225 Q230 Q235 Q240 Q250 Q260	24
	70 80 90 100 110 125	Q270 Q280 Q290 Q2100 Q2110 Q2125	5
	150 200	QN2150R ^{ⓄⓈ} QN2200R ^{ⓄⓈ}	1
Three Pole Common Trip			
	15 20 25 30 40 50 60 70	Q315 Q320 Q325 Q330 Q340 Q350 Q360 Q370	3
	80 90 100	Q380 Q390 Q3100	2
Half Module (1/2" per pole) 10,000 A.I.C.			
Poles	Amps	Catalogue Number [Ⓞ]	Standard Package
QT Dual (Twin)	15-15	Q1515NC	48
	15-20	Q1520NC	
	15-30	Q1530NC	
	15-40	Q1540NC	
	20-15	Q2015NC	
	20-20	Q2020NC	
	30-15	Q3015NC	
	30-20	Q2030NC	
30-30	Q3030NC		
40-15	Q4015NC		
Quad Type (1/2" per pole) 10,000 A.I.C. Common Trip - centre poles only.			
Poles	Ampere Rating	Catalogue Number [Ⓞ]	Standard Package
QT Quad	15-15	Q21515CTNC	24
	15-20	Q21520CTNC	
	15-25	Q21525CTNC	
	15-30	Q21530CTNC	
	15-40	Q21540CTNC	



Q115

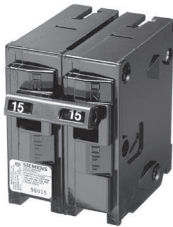

Q215

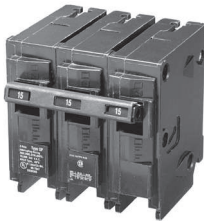

Q315



Q1515NC



Q21515CTNC

Ⓞ Typical catalogue number (ie. Q1515NC) represents two single-pole 15A circuit breakers - total width 1"
 Ⓞ Typical catalogue number (ie. Q21520CTNC) represents two single-pole, outer poles (two 15A 1-pole circuit breakers) and one 2-pole inner breaker with common trip (one 20A 2-pole circuit breaker) - total width 2"

Ⓢ Typical CSA Listed for frequent switching applications (SWD). 120V AC Fluorescent Lighting.
 Ⓞ Requires 4 panel circuits, 2 adjacent and 2 opposite. Two twist outs should be only removed.
 Ⓞ Will not fit in EQ3 or EQ4 loadcenters

Circuit Breakers

Surge Arrester and Replacement Main Breakers

Selection and Ordering Data



1
LOADCENTRES

 <p>EQ9675</p>	Replacement Main Breakers for EQ4 and EQ3 Loadcentres 22,000 A.I.C.			
	Poles	Ampere Rating	Catalogue Number	Standard Package
	N/A	60	Q260H	6
		100 125 150 200	EQ9675 EQ9677 EQ9683 EQ9685	1

Loadcentres

Arc-Fault and Ground Fault Circuit Interrupters

Selection

LOADCENTRES

Selection and Ordering Data

Poles	Ampere Rating	Interrupting Rating		
		10Ka	22kA	65Ka
		Catalogue Number		
Combination Arc Fault Circuit Interupters (AFCI) Detects all three possible types of arc faults: line-to-ground, line-to-neutral, and series. Pig Tail Version, Full Module (1" per pole)				
1	15 20	QA115AFCCSA QA120AFCCSA	QA115AFCH QA120AFCH	QA115AFCHH QA120AFCHH
2	15 20	Q215AFCCSA Q220AFCCSA	Q215AFCH Q220AFCH	N/A N/A
Plug On Neutral Version, Full Module (1" per pole)				
1	15 20	QA115AFNCNSA QA120AFNCNSA	N/A N/A	N/A N/A
2	15 20	Q215AFNCNSA Q220AFNCNSA	N/A N/A	N/A N/A
Pig Tail Twin Version, Half Module (1/2" per pole)				
1	15 20	Q1515AFCCSA Q2020AFCCSA	N/A N/A	N/A N/A
Plug On Neutral Twin Version, Half Module (1/2" per pole)				
1	15 20	Q1515AFNCNSA Q2020AFNCNSA	N/A N/A	N/A N/A
Dual Function AFCI/GFCI The Dual Function Circuit Breaker combines Combination Type AFCI and GFCI, protecting against both Arc Faults and (5mA) Ground Faults. Includes Self Test as an added safety feature. Pig Tail Version, Full Module (1" per pole)				
1	15 20	Q115DFCNSA Q120DFCNSA	Q115DFH Q120DFH	Q115DFHH Q120DFHH
Plug On Neutral Version, Full Module (1" per pole)				
1	15 20	Q115DFNCNSA Q120DFNCNSA	N/A N/A	N/A N/A
Ground Fault Circuit Interrupters, Class A (5mA) Sensitivity Provides Class A (5mA) ground fault protection. Intended for personnel protection. Includes Self Test as an added safety feature. Pig Tail Version, Full Module (1" per pole)				
1	15 20 30	QF115ACNSA QF120ACNSA QF130ACNSA	QF115AH QF120AH QF130AH	QF115AHH QF120AHH QF130AHH
2	15 20 30 40 50 60	QF215ACNSA QF220ACNSA QF230ACNSA QF240ACNSA QF250ACNSA QF260ACNSA	QF215AH QF220AH QF230AH QF240AH QF250AH QF260AH	N/A N/A N/A N/A N/A N/A
Plug On Neutral Version, Full Module (1" per pole)				
1	15 20 30	QF115ANCNSA QF120ANCNSA QF130ANCNSA	N/A N/A N/A	N/A N/A N/A
Ground Fault Equipment Protection (QE), Full Module (1" per pole) 30mA Sensitivity Provides protection of equipment from damaging line-to-ground faults currents.				
1	15 20 30	QE115 QE120 QE130	N/A N/A N/A	N/A N/A N/A
2	15 20 30 40 50 60	QE215 QE220 QE230 QE240 QE250 QE260	N/A N/A N/A N/A N/A N/A	N/A N/A N/A N/A N/A N/A

Loadcentres

Type BQ Bolt-on^① and Blue line Circuit Breakers

Selection

Selection and Ordering Data



LOADCENTRES

Full Module BQ Breakers (1" per pole) 10,000 A.I.C. & 22,000 A.I.C.				
Ampere Rating	10,000 A.I.C. Catalogue Number	22,000 A.I.C. Catalogue Number	Std. Pkg.	
Single Pole				
15	BQ1B015	BQ1B015H	12	
20	BQ1B020	BQ1B020H		
25	BQ1B025	BQ1B025H		
30	BQ1B030	BQ1B030H		
40	BQ1B040	BQ1B040H		
50	BQ1B050	BQ1B050H		
60	BQ1B060	BQ1B060H		
70	BQ1B070	BQ1B070H		
Two Pole Common Trip				
15	BQ2B015	BQ2B015H	6	
20	BQ2B020	BQ2B020H		
25	BQ2B025	BQ2B025H		
30	BQ2B030	BQ2B030H		
40	BQ2B040	BQ2B040H		
50	BQ2B050	BQ2B050H		
60	BQ2B060	BQ2B060H		
70	BQ2B070	BQ2B070H		
80	BQ2B080	BQ2B080H		
90	BQ2B090	BQ2B090H		
100	BQ2B100	BQ2B100H		
125	BQ2B125	—		
Three Pole Common Trip				
15	BQ3B015	BQ3B015H		4
20	BQ3B020	BQ3B020H		
30	BQ3B030	BQ3B030H		
40	BQ3B040	BQ3B040H		
50	BQ3B050	BQ3B050H		
60	BQ3B060	BQ3B060H		
70	BQ3B070	BQ3B070H		
90	BQ3B090	BQ3B090H		
100	BQ3B100	BQ3B100H		



BQ1B015

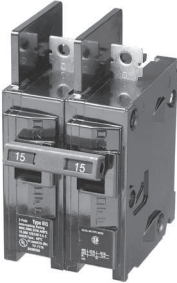

BQ2B015

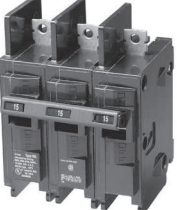

BQ3B015

BQ Screws are sold separately^①

Type Blue line circuit breakers		
Ampere Rating	Catalogue Number	Standard Package
15	BL1-015	20
20	BL1-020	
30	BL1-030	
40	BL1-040	
50	BL1-050	
15	BL2-015	10
20	BL2-020	
30	BL2-030	
40	BL2-040	
Description	Catalogue Number	Standard Package
Tie Handle	BLTH1	20
6 - 1 Pole Fillers	BLF6	

Note: These breakers are used as replacement in old ITE Loadcentres



BL1-015

① Order line side screw kits separately: 8217-6 (6 pcs.)
8217-12 (12 pcs.) 8217-100 (100 pcs.) 8217-200 (200 pcs.)

Loadcentres

Accessories and Replacement Parts

Selection

INSTA WIRE™

Selection and Ordering Data

LOADCENTRES

Catalogue Number	Description	Std. Pkg.
Tie Handle		
ECQTH2	QT Dual Tie Handle-Floating	25
ECQTH3	Q 2-Pole Tie Handle	50
QTH4	QT Dual Tie Handle - Bar Type	5
Blocking Device		
ECQL1	Handle Blocking Device (1,2 or 3 Pole)	10
ECQLD3	Padlocking Device (1,2 or 3 Pole) for full module breakers	
ECPLD1	Padlocking Device (1 Pole) for Twin type breakers	3
ECPLD2	Padlocking Device (2 Pole) for Quad type breakers	
Lock		
ECQFL2	Add-A-Lock (all EQ Loadcentres)	1
Neutral Lug Kits		
LK2	No. 4-2/0 CU/AL	1
LK3	No. 1-300 MCM CU/AL	
LK4	No. 1-400 MCM CU/AL	
Lug Kit[®]		
ECLK2225	No. 2-300 MCM CU/AL	1
Miscellaneous		
QF3	Three 1-Pole Fillers	1
SL3	Sliding Black Latch	
SL3W	Sliding White Latch	
IG21	Insulated Ground Bar Kit	
Truck-Kit	Contractor Truck Kit	
TRIMSCK1Z	Screws for trims "Zink"	
CIRNOLA32	Circuit labels up to 32 circuits for SEQ 125A	
CIRNOLA40	Circuit labels up to 40 circuits	
CIRNOLA60	Circuit labels up to 60 circuits	
DIRLBLK-EQLSEQ	Directory labels EQL, SEQ	
DIRLBLK-SM	Directory labels SEQ side mounted NMMB	
DIRLBLKSEQ60	Directory Card "Package of 25"	
MAINLBLK-EQLSEQ	Replacement Main Label Kit SEQ-EQL	
TUP-RA236QF	White Powder Coat Spray Paint	
TUP-PL126Q	Grey Powder Coat Spray Paint	

®These lug kits simply plug on to the bus of any SEQ or EQL Loadcentre as sub-feed or through-feed lugs to take advantage of CEC Rule 14-100 (c).

Loadcentres



Accessories and Replacement Parts

Selection





LOADCENTRES

SEQ Loadcentres

	# of Circuits	Catalogue Number	Door Kit		Door & Trim	
			Grey	White	Grey	White
 <p>Door Kit</p>  <p>Door & Trim</p>	12/24	SEQ12060SM	DK1216SM-1	DK1216SM-1W	DK12SM	DK12SMW
	16/32	SEQ16060SM			DK16SM	DK16SMW
	24/48	SEQ24060SM	DK24SM-1	DK24SM-1W	DK24SM	DK24SMW
	12/24	SEQ12100SM	DK1216SM-1	DK1216SM-1W	DK12SM	DK12SMW
	16/32	SEQ16100SM			DK16SM	DK16SMW
	24/28	SEQ24100SM SEQ24125SMK SEQ24125SM	DK24SM-1	DK24SM-1W	DK24SM	DK24SMW
	24/48	SEQ24150 SEQ24200	N/A	N/A	DKS24-2A	DKS24-2AW
	32/64	SEQ32100SM SEQ32125SM	DK32SM-1	DK32SM-1W	DK32SM	DK32SMW
	32/64	SEQ32150 SEQ32200	N/A	N/A	DKS32-2A	DKS32-2AW
	40/80	SEQ40100 SEQ40125	N/A	N/A	DKS40-1A	DKS40-1AW
40/80	SEQ40150 SEQ40200	N/A	N/A	DKS40-2A	DKS40-2AW	
60/120	SEQ60200	N/A	N/A	DKS60-2A	DKS60-2AW	

SEQ Loadcentres

	# of Circuits	Catalogue Number	Main Breaker Cover		Branch Breaker Cover	
			Grey	White	Grey	White
 <p>Main Breaker Cover</p>  <p>Branch Breaker Cover</p>	12/24	SEQ12060SM	DKMCSM	DKMCSMW	SEQ12060SM-T	SEQ12060SM-TW
	16/32	SEQ16060SM			SEQ16060SM-T	SEQ16060SM-TW
	24/48	SEQ24060SM			SEQ24060SM-T	SEQ24060SM-TW
	12/24	SEQ12100SM			SEQ12100SM-T	SEQ12100SM-TW
	16/32	SEQ16100SM			SEQ16100SM-T	SEQ16100SM-TW
	24/28	SEQ24100SM SEQ24125SMK SEQ24125SM			SEQ24100SM-T	SEQ24100SM-TW
					SEQ24125SM-T	SEQ24125SM-TW
					SEQ24125SM-T	SEQ24125SM-TW
	24/48	SEQ24150 SEQ24200	N/A [Ⓞ]	N/A [Ⓞ]	SEQ24-TA	SEQ24-TAW
	32/64	SEQ32100SM SEQ32125SM	DKMCSM	DKMCSMW	SEQ32100SM-T	SEQ32100SM-TW
SEQ32125SM-T					SEQ32125SM-TW	
32/64	SEQ32150 SEQ32200	N/A [Ⓞ]	N/A [Ⓞ]	SEQ32-T	SEQ32-TW	
40/80	SEQ40100 SEQ40125			SEQ40100-T	SEQ40100-TW	
40/80	SEQ40150 SEQ40200			SEQ40-T	SEQ40-TW	
60/120	SEQ60200			SEQ60-T	SEQ60-TW	

[Ⓞ] Branch Breaker Cover part covers the main breaker area and branch circuits.

Loadcentres

Accessories and Replacement Parts



LOADCENTRES

EQL Loadcentres

	# of Circuits	Catalogue Number	Door Kit	
			Grey	White
			2/6	EQL260S
4/8	EQL4100			
8/16	EQL8100D	DK8-A	DK8-AW	
12/24	EQL12125D	DK12-A	DK12-AW	
16/32	EQL16125D	DK16-A	DK16-AW	
24/48	EQL24125D	DK24-A	DK24-AW	
32/64	EQL32200D	DKL32-2A	DKL32-2AW	
40/80	EQL40200D	DKL40-2A	DKL40-2AW	

SNC Loadcentres

	# of Circuits	SNC Catalogue Number	SNC Door Kit	
			Grey	White
			12/24	US2:SNC1224L1125
16/32	US2:SNC1632L1125	US2:RSCT1632L1125	US2:RSCT1632L1125W	
24/48	US2:SNC2448L1125	US2:RSCT2448L1125	US2:RSCT2448L1125W	
30/48	US2:SNC3048L1200	US2:RSCT3048L1200	US2:RSCT3048L1200W	
40/60	US2:SNC4060L1200	US2:RSCT4060L1200	US2:RSCT4060L1200W	
12/24	US2:SNC1224L1125W	US2:RSCT1224L1125	US2:RSCT1224L1125W	
16/32	US2:SNC1632L1125W	US2:RSCT1632L1125	US2:RSCT1632L1125W	
24/48	US2:SNC2448L1125W	US2:RSCT2448L1125	US2:RSCT2448L1125W	
30/48	US2:SNC3048L1200W	US2:RSCT3048L1200	US2:RSCT3048L1200W	
40/60	US2:SNC4060L1200W	US2:RSCT4060L1200	US2:RSCT4060L1200W	

EQ3 & EQ4 Loadcentres

	# of Circuits	Catalogue Number		Door Kit	
		EQ3	EQ4	Grey	White
		12	N/A	EQ412100	DKEQ1218
18	N/A	EQ418100			
24	EQ324225	EQ424225	DKEQ2430	N/A	
30	N/A	EQ430225			
40	EQ340225	N/A	DKEQ42	N/A	
42	N/A	EQ442225			

EQ3 & EQ4 Service Entrance Rated

	# of Circuits	Catalogue Number		Door Kit	
		EQ3	EQ4	Grey	White
		24	EQ324BQ125	EQ424BQ100	DKEQ24BQ
32	EQ332BQ125	N/A	DKEQ42	N/A	
42	N/A	EQ442QR100	DKEQ42QR	N/A	
		EQ442QR125 EQ442QR125C EQ442QR150 EQ442QR200	DKEQ42QR	N/A	

Loadcentres Surge Protection

Circuit Breaker and Surge Protective Device (SPD)

Selection

Features

- 2 inch wide plug-on design
 - Includes (2) 1 Pole circuit breakers
 - No loss of loadcentre spaces
- Easy to install and perfect for retrofit
- LEDs provide protection status

Benefits

By installing a Siemens Circuit Breaker and Surge Protective Device (SPD) in the loadcentre of the residence, surge protection is provided for all branch circuits^①.

Two green LED indicator lights are provided to show that surge protection is provided for all circuits connected to the loadcentre. These breakers should be used for circuit protection of frequently used household or facility circuits because the lights and devices connected to these circuits provide an effective indication that surge protection is being provided.

The circuit breaker and SPD utilize Siemens-built 150V AC, 40mm, metal oxide varistors (MOVs). The maximum impulse rating for the SPD module is 40kA. The standard interrupting rating for the circuit breakers is 10kAIC. All Type QP circuit breakers and SPD are plug-on style, with load terminals provided. The devices are rated for 120/240V AC and are calibrated for 40 degrees C maximum ambient applications.

Breaker Type	Ampere Rating	Catalogue Number	Surge Type
QP 1- Pole 120/240V AC 10K AIC	(2) 15	QSA1515SPD	SPD
	(2) 20	QSA2020SPD	SPD

Catalogue Number	QSA1515SPD QSA2020SPD
Amperage	15 or 20 Amp
Number of Poles	(2) 1-Pole Circuit Breakers
Initial Clamping Level	240 Volts
Transient Energy Rating	360 Joules line-to-neutral 720 Joules line-to-line
Transient Suppression	500 volts peak, line-to-neutral
Voltage Rating	1000 volts peak, line-to-line
Peak Current Rating (impulse)	40,000 amperes
Discharge Voltage Characteristic	@ 1,500A, 600 volts @ 5,000A, 800 volts (both line-to-neutral)
Discharge Current Withstand Rating	10,000 amperes line-to-neutral
Circuit Breaker Interrupting Rating	10,000A, 120/240V AC
Listings/Certifications	UL, CSA Meets UL 1449 4th Edition



1
LOADCENTRES

^① For warranty information please refer to the surge website www.usa.siemens.com/surge

Loadcentres Surge Protection

Power Service Entrance Surge Protection

Selection

FirstSurge™

Total Home Protection

Siemens believes today's residential surge protectors come up short when protecting today's modern home filled with smart appliances and electronics.

This is why we developed our FirstSurge™ commercial class total home surge protectors. These electrical system surge protectors are sized for where you live. They will let you know when there is something wrong or when they are worn out.

Based upon thunderstorm frequency, geographic location, and home size, we developed a surge exposure map correlating with FirstSurge™ current capacities known to provide years of protective service for each shaded area.

Sized For Where You Live

Model	Surge Capacity
FirstSurge™ Power	(FS060) 60,000 A
FirstSurge™ Plus	(FS100) 100,000 A
FirstSurge™ Pro	(FS140) 140,000 A

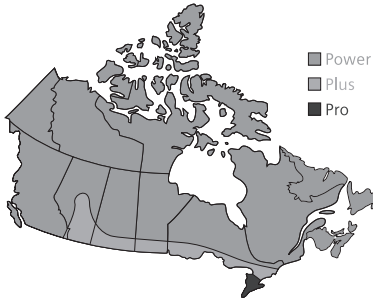

Know You're Protected:

3 Stage Commercial Grade Notification

When there is a problem, Siemens FirstSurge™ takes the guesswork out of knowing when it is time to be replaced. What will you see and hear when this occurs?

Audible Alarm: Beeps
 Green LED(s): Extinguish
 Red Service Light: Flashes

Ground Reference Monitoring (GRM)

FirstSurge™ is GRM-equipped notifying you a rare safety hazard exists due to a compromised electrical system neutral to ground bond. What will you see and hear when this occurs?

Audible Alarm: Beeps
 Green LED(s): Remains Lit
 Red Service Light: Flashes

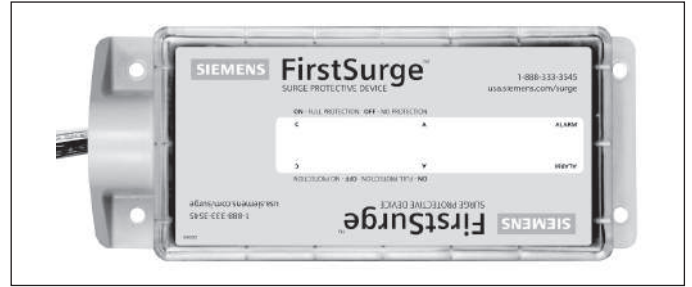

Features & Benefits

- UL 1449 4th Ed Listed, CSA 22.2 No.269.2-13, Type 2 Surge Protective Device (SPD)
- Rated for 120/240 split phase panels up to 400A
- Surge Current Capacities:
 - 60,000 A
 - 100,000 A
 - 140,000 A
- 3 Stage Commercial Grade Notification
- Ground Reference Monitoring (GRM)
- Installs onto any brand loadcenter
- Type 4 rated outdoor enclosure
- 10 year product and connected equipment warranty*

Technical Specifications		
Surge Spike Capacity	FirstSurge™ Power (FS060)	60,000 A
	FirstSurge™ Plus (FS100)	100,000 A
	FirstSurge™ Pro (FS140)	140,000 A
Line Voltage	120/240 Split Phase, 50/60 Hz	
UL 1449 4th Ed VPR	L-N: 600 V	
	L-G: 600 V	
	N-G: 600 V	
	L-L: 900 V	
Rated Voltage (MCOV)	150V – L-N, L-G, and N-G; 300V – L-L	
Response Time	<1 nanosecond	
Enclosure	NEMA 4X Indoor and Outdoor Rated	
Selection Information		
FirstSurge™ Power	FS060	
FirstSurge™ Plus	FS100	
FirstSurge™ Pro	FS140	
FirstSurge™ Flush Mount Kit	XMFMKIT	

*See warranty for details

Loadcentres Surge Protection

Telephone Service Entrance Surge Protection

Siemens FSPHONE is a 2 pair, hardwired surge protector for telephone, DSL or modem connected electronics in residential and light commercial applications. The FSPHONE protects against electrical power surges that can enter through the main telephone connection and is equipped with a failshort device to permanently ground the telephone line in the event of a power cross.

The FSPHONE is designed for indoor applications or can be mounted inside another weatherproof enclosure for outdoor mounting applications.

The FSPHONE4X consists of the FSPHONE plus a weatherproof enclosure to facilitate indoor or outdoor applications. The enclosure is molded of temperature and humidity resistant thermoplastic to resist cracking and discoloration. The cover can be secured with a tie wrap or similar locking device.

For total home protection please use FirstSurge™ to protect your incoming AC Power lines and FSPHONE to protect your incoming telephone line.

Features & Benefits

- UL listed
- Hardwired Modem/Fax/DSL protection
- Easy to install
- Exceptionally fast response time
- Low insertion loss
- Available with or without enclosure
- 5-Year product warranty*

Selection



Technical Specifications	
Catastrophic Surge Circuit	Yes
Spike Capacity	200 Amps
Let Through Voltage	<270 V
Overcurrent Protection	Yes
Response Time	<1 nanosecond
Enclosure	Yes
Agency Approvals & Warranty	
UL/cUL Listings	497C
Meets Telcordia (formally Bellcore) GR-974-CORE Requirements for Telecommunications Line Protectors	Yes
Product Warranty	FS140
Catalogue Number	
FSPHONE	2 pair protection module
FSPHONE4X	2 pair protection module & 1 Weatherproof Enclosure

UL Model No. - SATH2

Coaxial Service Entrance Surge Protection

Siemens FSCATV shields coaxial connected electronics in residential and light commercial applications against electrical transient damage, including lightning, from entering through the main cable connection.

FSCATV includes a section of coaxial cable with female to female splice for line side application. The Siemens warranty covers product defects for 5 years. To have complete protection for your equipment, home, or business, it is important to protect AC power lines and all data lines the equipment is connected through.

Features & Benefits

- UL Listed
- Rated for CATV, DSS, TV, VCR, and Cable Modem
- Easy to install
- Standard Female to Female F connector
- Low insertion loss
- Automatic recovery
- 5 Year product warranty*

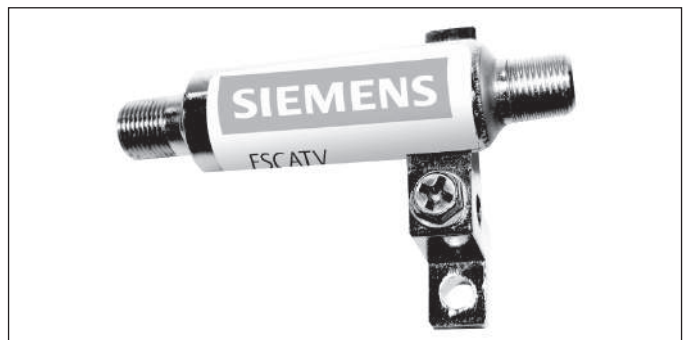

Technical Specifications	
Frequency Range	DC thru 1.5 GHz
Catastrophic Surge Circuit	Yes
Spike Capacity	5000 Amps, 8/20 μSec
Impedance	75 Ohms
Overcurrent Protection	Yes
Return Loss	30dB @ 1 GHz
Insertion Loss	<0.1dB
Agency Approvals & Warranty	
UL/cUL Listings	497C
Meets IEEE C62.41.1 Requirements	Yes
Product Warranty	FS140
Catalogue Number	
FSCATV	F-Type Inline Coax Protector

UL Model No. - Surgeassure™ SAVFFF

*See warranty for details

Loadcentres

Knockout Data

Selection

		K.O. Qty			
		A	B	C	D
EQL8	Box	6	6	6	4
	Top	1	6	4	2
	Bot.	1	6	4	2
EQG 6 EQL 12	Box	6	6	6	4
	Top	1	6	4	2
EQG 8NSND	Bot.	1	6	4	2
EQG 10 EQL 16	Box	6	8	8	4
	Top	1	6	4	2
EQG 12NSND	Bot.	1	6	4	2
		K.O. Trade Dia.			
A	3/4" - 1" - 1 1/4" - 1 1/2"				
B	1/2" - 3/4"				
C	1/2"				
D	1/4"				

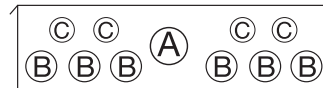
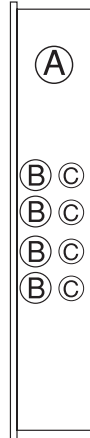
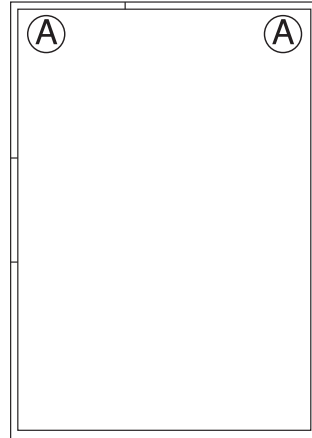

Top and Bottom

		K.O. Qty.				
		A	B	C	D	E
EQG 18	Box	4	2	-	18	16
EQL 24	Top	1	-	1	6	4
EQG 20NSND	Bot.	1	-	1	6	4
EQG 24	Box	4	2	2	2	36
EQL 32	Top	1	1	1	4	13
EQG 28NSND	Bot.	1	1	1	4	13
EQL 34	Box	4	2	2	2	36
EQL 40	Top	1	1	1	4	13
EQG 36NSND	Bot.	1	1	1	4	13
		K.O. Trade Dia.				
A	1 1/4" - 1 1/2" - 2" - 2 1/2"					
B	3/4" - 1" - 1 1/4"					
C	1/2" - 3/4" - 1"					
D	1/2" - 3/4"					
E	1/2"					

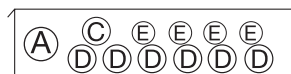
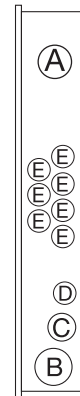
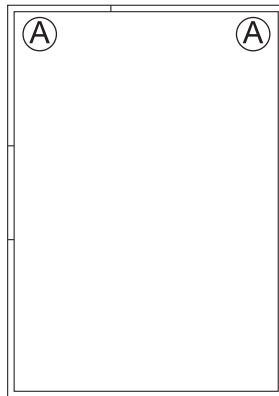

Top and Bottom for
EQL 24
EQG 18
EQG 20NSND

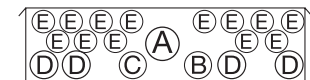

Top and Bottom for
EQL 32 & 40 cir.

Loadcentres

Knockout Data

Selection

Service Entrance Loadcentres with Plug-in Breakers

1
LOADCENTRES

		K.O. Qty.				
		A	B	C	D	E
SEQ 12 SM	Box	4	2	0	10	8
SEQ 16 SM	Top	3	0	0	0	2
	Bot.	1	0	1	6	4
SEQ 24 SM	Box	4	2	-	18	16
SEQ 32 SM	Top	3	-	-	-	2
	Bot.	1	-	1	6	4
	Box	4	2	2	2	22
SEQ 24	Top	1	1	1	4	13
	Bot.	1	1	1	4	13
	Box	4	2	2	2	36
SEQ 32	Top	1	1	1	4	13
	Bot.	1	1	1	4	13
	Box	4	2	2	2	36
SEQ 40	Top	1	1	1	4	13
	Bot.	1	1	1	4	13
	Box	4	2	2	2	68
SEQ60200	Top	1	1	1	4	13
	Bot.	1	1	1	4	13

K.O. Trade Dia.	
A	1 1/4" - 1 1/2" - 2" - 2 1/2"
B	3/4" - 1" - 1 1/4"
C	1/2" - 3/4" - 1"
D	1/2" - 3/4"
E	1/2"

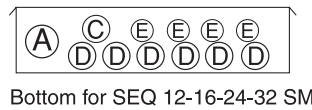
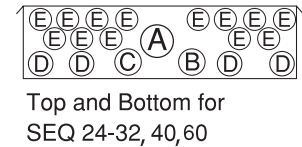
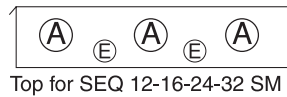
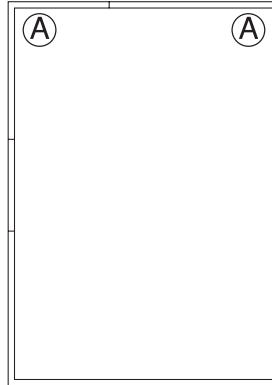

Service Entrance Loadcentres (Type 3R) Bottom Only

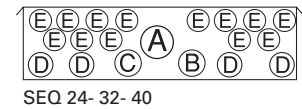
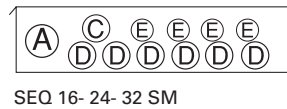

EQ Loadcentres with Plug-in or Bolt-on Breakers

		K.O. Qty.				
		A	B	C	D	E
All	Box	6	-	-	4	-
EQ 1PH	Top	1	1	1	4	13
EQ 3PH	Bot.	1	1	1	4	13

K.O. Trade Dia.	
A	1 1/4" - 1 1/2" - 2 1/2"
B	3/4" - 1" - 1 1/4"
C	1/2" - 3/4" - 1"
D	1/2" - 3/4"
E	1/2"

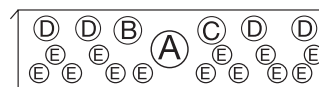
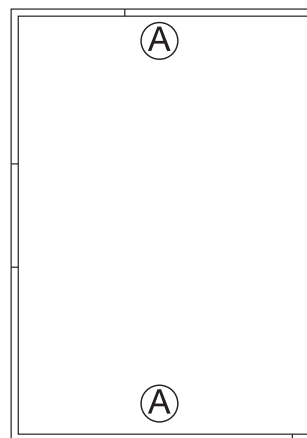

Loadcentres

Line Diagrams/Dimension Drawings for Circuit Breakers/Lug Data

Selection

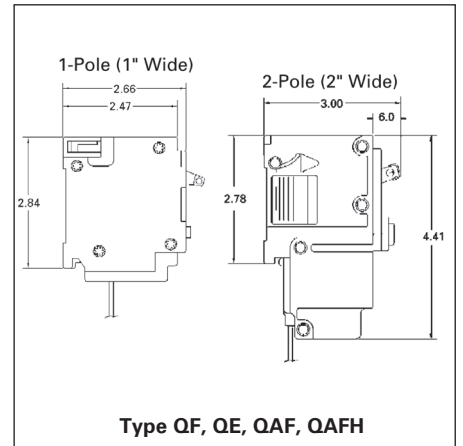
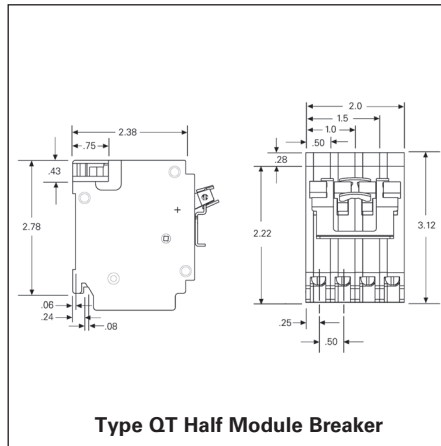
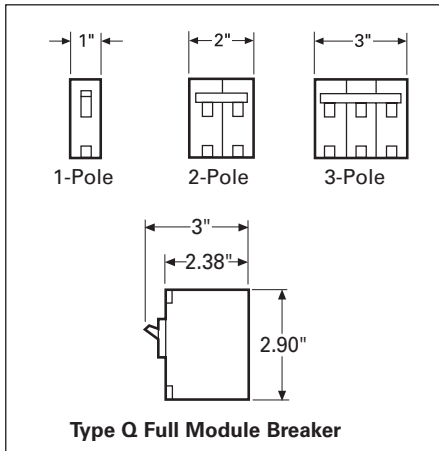

Lug Data

Circuit Breaker Type	Circuit Breaker Ampere Rating	Cables Per Connector	Connector Wire Range
LOAD SIDE			
Q	15-30	1 1	#14-#8 AWG Cu #12-#8 AWG Al
	40-50	1 1	#8-#6 AWG Cu #8-#4 AWG Al
	60-70	1 1	#6-#2/0 AWG Cu #6-#2/0 AWG Al
	80-125	1 1	#8-#2/0 AWG Cu #8-#2/0 AWG Al
QNR	150-200	1	#1-300kcmil Cu-Al
QT	15-30	1 1	#14-#8 AWG Cu #12-#8 AWG Al
	40	1	#8 AWG CU-Al
QF, QE	15-30	1 1	#14-#10 AWG Cu #12-#8 AWG Al
	40-60	1 1	#8-#6 AWG Cu #8-#4 AWG Al
QAF, QAFH	15-20	1 1	#14-#12 AWG Cu #12-#10 AWG Al

