



BURNDY® SOLUTIONS Master Catalog



This Page Intentionally Left Blank



www.burndy.com
1-800-346-4175 (US)

Sections

Section A — Mechanical

Section B — Small Terminals

Section C — Compression Connections

Section D — Shrink Tubing

Section E — Grounding
(Compression, Mechanical, Exothermic, Wiley Solutions)

Section F — Accessories

Section G — Wire Management

Section H — Overhead Distribution

Section I — Transmission

Section J — OH Distribution & Transmission

Section K — Underground

Section L — Bolted Substation

Section M — Welded/EHV Substation

Section N — Tooling

Section O — Reference

Most frequently ordered catalog numbers are highlighted in BLUE

This Page Intentionally Left Blank

Table of Contents

Lightning Protection Information A-2	QIKLUG™ (Cu) Types QA / QQA.....A-17	Transformer Lug Kits (Cu/Al) Type KAU-KITA-33
Special Features..... A-2	QIKLUG™ Two Conductor (Cu) Type Q2AA-18	Mechanical Adapters (Cu/Al) Type KAP / KAPOA-34
SERVIT® Split-bolts (Cu/Cu-Weld) Types KS / KS-3 A-3	QIKLUG™ Three Conductor (Cu) Type Q3A.....A-18	Splice/Reducer (Cu/Al) Type AMS.....A-35
SERVIT® Covers Type SC..... A-3	QIKLUG™ (Cu) Type QB.....A-19	POLYTAP™ Insulated Gutter Tap (Cu/Al) Type KPU-TC.....A-36
Universal SERVIT® Split-bolts (Cu/Al/ACSR/AAAC/5005/Steel) Type KSU..... A-4	QIKLUG™ Two Conductor (Cu) Type Q2B.....A-19	Riser Tap (Cu/Al) Type UCU-ACA-36
TRITAP™ SERVIT® Split-bolts (Al/Cu) Type KSA..... A-5	QIKLUG™ (Cu) Type QDA.....A-20	Above Grade Splice Kit (Cu/Al) Type AGSKITA-37
OKLIP™ (Cu/Cu-Weld) Type KVS ... A-6	QIKLINK™ Splice/Reducer (Cu) Type QR.....A-20	Underground/Watertight Splice Kit (Cu/Al) Type UGSKITA-37
Universal OKLIP™ (Cu/Al/ACSR/ AAAC/5005) Type KVSU A-6	VARILUG™ (Cu) Types VA / VVA.....A-21	Direct Burial Splice Kit (Cu) Type UGSKIT8A-38
OKLIP™ (Cu/Cu-Weld) Type KVSW..... A-7	Lay-in QIKLUG™ (Cu) Type CL50-1.....A-22	Direct Burial In-Line Splice/Reducer (Cu/Al) Type UGS350ULDB.....A-38
OKLIP™ (Cu/Al/ACSR/AAAC/5005) Type KVS-A A-7	Lay-in QIKLUG™ (Cu) Type CL.....A-22	THE MOLE™ Direct Burial Splice/Reducer Type BISR-DBA-39
VERSITAP™ Parallel Clamp (Cu/Cu-Weld) Type QPX A-8	QIKLUG™ Lay-In (Cu/Al) Type BGBL.....A-23	Direct Burial Submersible Connectors (Cu/Al) Type BIBS-DB.....A-40
Universal VERSITAP™ Parallel Clamp (Cu/Al) Type QPX-Y A-9	Shear Bolt Mechanical Connectors (Cu/Al) Type K-SBA-24	UNITAP™ Clear Insulated Multi-Tap (Cu/Al) Code OnlyA-41
BARTAP™ (Cu Cable to Flat) Type QGFL.....A-10	Universal Terminals (Cu/Al) Type KA-U / KKA-UA-26	UNITAP™ Clear Insulated Multi-Tap (Cu/Al) Code & FlexA-49
Transformer Tap Adapter (Cu/Al) Type FCB.....A-10	Two Conductor Universal Terminals (Cu/Al) Type K2A-UA-27	UNITAP™ UV Rated BlackA-58
Insulation Piercing (Cu/Al) with Shear Bolt Type BIPCA-11	Three Conductor Universal Terminals (Cu/Al) Type K3A-U / KK3A-UA-28	VERSIPOLE™ Configurable Power Distribution Blocks (Cu/Al) Code and FlexA-61
Insulation Piercing (Cu/Al) Type BIPCA-13	Four Conductor Universal Terminals (Cu/Al) Type K4A-U / KK4A-UA-29	VERSIPOLE™ (Cu/Al) Double-Wide, Box-to-Stud, Stud-to-Stud.....A-64
SCRULUG™ (Cu) Type KPA.....A-14	Panelboard Universal Lugs (Cu/Al) Type K11A-U / K21A-U / K22A-UA-29	VERSIPOLE™ (Cu/Al) Double-Wide, Lay-In Style.....A-66
SCRULUG™ Unplated (Cu) Type KPA-UPA-14	Universal Terminals (Cu/Al) 1-4 Conductors, NEMA-Spacing Type K-A-U2NA-30	
SCRULUG™ Offset Tongue (Cu) Type KLUA-15	Six and Eight Conductor Universal Terminals (Cu/Al) Types K6A-U / KK6A-U / K8A-U / KK8A-U.....A-31	
KA-LUG™ (Cu) Type KA.....A-16	Stacked and Lay-In Style Universal Terminals (Cu/Al) Types KK-A-US, KK-A-U-L.....A-32	
VERSILUG™ (Cu) Type EA.....A-16		

Most frequently ordered catalog numbers are highlighted in BLUE

LIGHTNING PROTECTION INFO.

Basic rules for selection are:

1. Must be like material to the conductor.
2. Two bolts to ground rod - minimum.
3. Cable to cable connections can be anything, one bolt, two bolt, compression, etc.
4. Cable to steel structure must have 8 square inch contact with steel.
5. Heavy duty stacks - mechanical only.

6. On all connectors with heavy duty stack rating, we must offer 1/16" thick lead plating as an option. The reason for that is closest 25 ft. to stack opening must use lead coated product.

✓ Complies with NFPA 78-86 Ordinary Structures.

✓ ✓ Complies with NFPA 78-86 Heavy Duty Stacks. (Order: LD for Lead Plating for Heavy Duty Stack applications.)

SPECIAL FEATURES

Other features are also available for products listed, such as undrilled or special drilling, 45° or 90° pad angles, belling for extra flexible cable, smooth or special threaded studs, special labeling or packaging, extra long braid, and nuclear certification. Please contact BURNDY Customer Service for any inquiries.

**ALL OTHER SPECIAL REQUESTS
PLEASE CONTACT
BURNDY CUSTOMER SERVICE
1-800-346-4175**

REVOLUTIONARY BURNDY® DESIGN MEETS STRICT UL486B STANDARDS

Unique "bite and grip" TRITAP™ SERVIC® contact delivers safe, long-term reliability — even without scratch brushing ... without oxide inhibiting compounds.†

... and puts the bite on aluminum connections forever!

For use on all combinations

- Aluminum to aluminum
- Aluminum to copper
- Copper to copper



† When used in NEC applications of insulated cables only.

Patented

Triangular edges bite into cable to break through surface oxides:

- provide low contact resistance
- produces gas tight seal

Tin-plated contact surface inhibits oxide formation

Special heat-treated hard, aluminum alloy

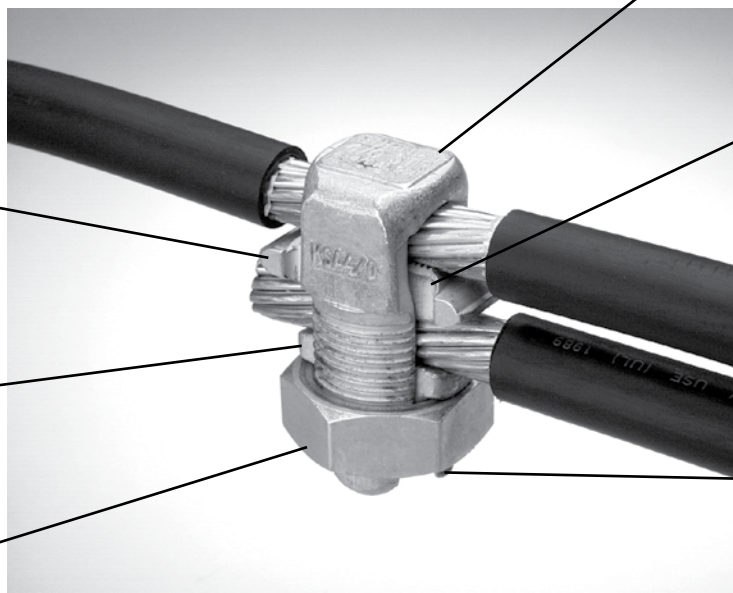

Available in sizes from #10 through 500 kcmil

Spacer provides built-in separation to retard galvanic corrosion

Anti-galling, high efficiency threaded components result in high contact force. Easily installed using standard, everyday wrenches.

TYPES KS & KS-3

SERVIT®



Copper, Copperweld

Compact, high strength, high copper alloy SERVIT® split-bolt has free-running threads and easy to grip wrench flats. Highly resistant to season cracking and corrosion, the SERVIT® provides maximum pressure and assures a secure connection on all combinations of run and tap conductors. Type KS-3 accommodates 3 maximum size conductors.

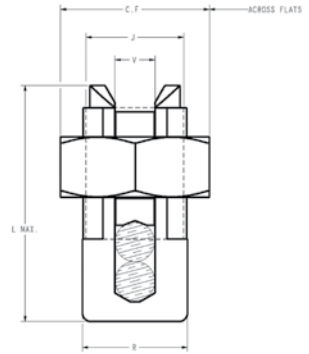

Catalog Number	Cross Flats	L	W	Conductor						▲ Recommended Tightening Torque (in-lb)
				Copper		Copperweld				
				Equal Run & Tap	Min Tap with Max Run	Maximum Run and Tap				
				Sol.	Str.	Type A	Type D			
† KS90	0.50	0.85	0.38	12 - 10 Str.	16 Str.	#10	—	—	—	80
† KS15	0.50	0.85	0.38	10 - 8 Str.	14 Str.	#8	—	—	—	80
† KS17	0.63	1.14	0.45	8 Str. - 6 Sol.	14 Str.	#6	3 #12	8A	9-1/2D	165
* KS173	0.62	0.98	0.70	8 Str. - 6 Sol.	16 Str.	#6	3 #12	8A	9-1/2D	165
† KS20	0.69	1.20	0.51	8 Str. - 4 Sol.	14 Str.	#4	3 #10	6A	8D	165
* KS203	0.68	1.17	0.78	8 Str. - 4 Sol.	14 Str.	#4	3 #10	6A	8D	165
† KS22	0.75	1.50	0.60	6 Str. - 2 Sol.	14 Str.	#2	3 #8	4A	6D	275
* KS223	0.74	1.33	0.84	6 Str. - 2 Sol.	14 Str.	#2	3 #8	4A	6D	275
† KS23	0.82	1.54	0.62	6 Str. - 2 Str.	14 Str.	#1	3 #7	3A	5D	275
† KS25	0.94	1.77	0.73	4 Str. - 1/0 Str.	14 Str.	2/0	3 #5	2A	4D	385
† KS26	1.05	1.94	0.82	2 Str. - 2/0 Str.	14 Str.	3/0	7 #7	—	—	385
† KS27	1.36	1.86	1.17	1 Str. - 3/0 Str.	8 Sol.	—	—	—	—	500
† KS29	1.36	2.07	1.17	1 Str. - 250	8 Str.	4/0	7 #5	—	—	650
† KS31	1.70	2.51	1.41	1/0 Str. - 350	1/0 Str.	—	19 #8	—	—	650
† KS34	1.82	2.79	1.48	2/0 Str. - 500	2/0 Str.	—	19 #6	—	—	825
KS39	2.31	3.29	1.94	4/0 Str. - 750	4/0 Str.	—	19 #5	—	—	1000
KS44	2.56	3.73	2.19	300 - 1000	4/0 Str.	—	—	—	—	1100

▲ Listed torque values are for maximum conductor combinations accommodated. Consult UL486 Tables 7-4, 7-5, 7-6 for smaller conductor combinations. See note LIGHTNING PROTECTION INFO.

* Not UL Listed or CSA Certified.

† In addition to UL Listed for wire connectors and CSA Certified, these items are also UL rated for direct burial.

TYPE SC

SERVIT® COVER



HUG-A-BUG

Used indoors or outdoors, this compact, one-piece plastic SERVIT® cover saves time and material, eliminates costly taping of split-bolts. Positive latch snaps easily and quickly over connector, ideal for tight quarters. Self-positioning plastic fingers wrap around wires fully insulating joint. UL Listed for 600 volt indoor application with type KS. Three covers accommodate a range of 6 SERVIT® sizes through 2/0 Str.

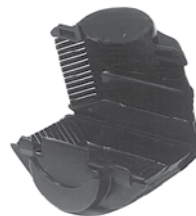

Catalog Number	For Use With
SC4	KS17, KS173, KS20, KSU17, KSU20
SC2	KS22, KS203, KS23, KS223, KSA6, KSA4, KSU22, KSU23
SC2/0	KS25, KS26, KSA2, KSA1/0, KSU25, KSU26

TYPE KSU

UNIVERSAL SERVIT®

All Combinations of Copper, Aluminum, ACSR, AAAC, 5005, and Steel

Tin-plated, high strength, copper alloy SERVIT® split-bolt with spacer. Spacer separates dissimilar conductors and provides long contact length that prevents high pressure point contacts between run and tap conductors.

Use of PENETROX™ joint compound recommended with Aluminum and ACSR.

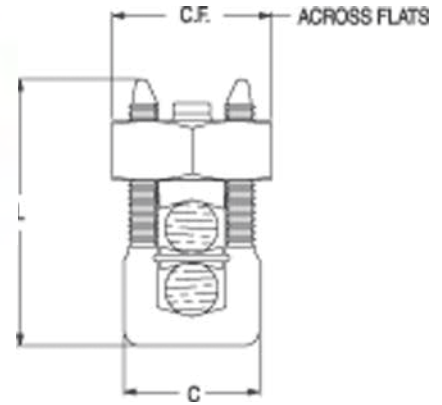

Copper Only



486A
Copper Only

Catalog Number	Cross Flats	L	W	Conductor							Recommended Tightening Torque (in-lb)
				Run		Tap		Steel (Max Conductor)			
				Copper & Aluminum	ACSR AAAC 5005	Copper & Aluminum	ACSR AAAC 5005	Sol. BWG	3 Str. BWG	Nom. Dia.	
KSU17	0.62	0.92	0.42	12 Sol. - 6 Sol.	8 (6-1)	12 Sol. - 6 Sol.	8 (6-1)	8	—	5/32	165
KSU20	0.69	1.05	0.48	10 Sol. - 4 Sol.	6 (6-1)	10 Sol. - 4 Sol.	6 (6-1)	6	8	7/32	165
KSU22	0.74	1.25	0.57	10 Sol. - 2 Sol.	6 (6-1) - 4 (7-1)	10 Sol. - 2 Sol.	6 (6-1) - 4 (7-1)	4	6	1/4	275
KSU23	0.81	1.48	0.59	8 Str. - 2 Str.	3 (6-1) - 2 (6-1)	8 Sol. - 2 Str.	6 (6-1) - 2 (6-1)	—	4	5/16	275
KSU25	0.93	1.77	0.70	2 Str. - 1/0 Str.	3 (6-1) - 1 (6-1)	10 Str. - 1/0 Str.	6 (6-1) - 1 (6-1)	—	—	3/8	385
KSU26	1.04	1.93	0.79	2 Str.-2/0 Str.	1 (6-1) - 1/0 (6-1)	8 Str. - 2/0 Str.	6 (6-1) - 1/0 (6-1)	—	—	7/16	385
KSU27	1.38	2.34	1.12	1 Str. - 3/0 Str.	1 (6-1) - 2/0 (6-1)	8 Sol. - 3/0 Str.	8 (6-1) - 2/0 (6-1)	—	—	1/2	500
KSU29	1.38	2.50	1.58	1Str. -250 kcmil	2/0 (6-1) - 4/0 (6-1)	8 Str. - 250	6 (6-1) - 4/0 (6-1)	—	—	1/2	650
KSU31	1.69	2.88	1.36	1/0 Str. - 350 kcmil	3/0 (6-1) - 4/0 (6-1)	4 Str. - 350	4 (6-1) - 4/0 (6-1)	—	—	5/8	650
KSU34	2.00	3.12	1.47	400 - 500 kcmil	336 (30-7) - 477 (18-1)	2 Str. - 500	2 (6-1) - 477 (18-1)	—	—	—	825

Accommodates compressed conductors within conductor ranges.

✓ See note LIGHTNING PROTECTION INFO.

TYPE KSA

TRITAP™ SERVIT®

All Combinations of Aluminum to Aluminum, Aluminum to Copper and Copper to Copper, Aluminum Alloy Tin Plated

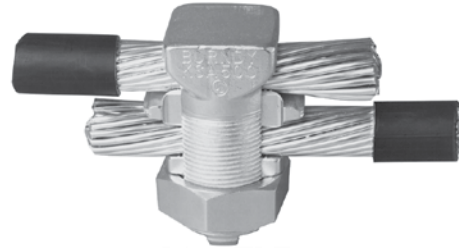

PATENTED TRIANGULAR PENETRATION TECHNOLOGY (TPT) CONTACT

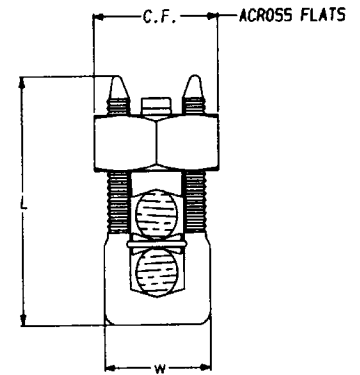

Features & Benefits

- No scratch brushing required
- No oxide inhibitor required
- Orients the conductor
- Provides maximum pressure and assures a secure connection of run and tap conductors
- Facilitates piercing the aluminum conductor surface oxides
- UL 486B listed, 90°C rated
- Provides a low contact resistance
- Provides equal coefficient of expansion
- Inhibits the reformation of oxides by producing a gas-tight seal
- Provides improved retention of minimum to maximum conductor combinations

Catalog Number	Cross Flats	L	W	Alum. to Alum., Alum. to Copper, Copper to Copper Conductors			Recommended ▲ Tightening Torque (in-lb)
				Max Run to Max Tap	Min Run to Min Tap	Max Run to Min Tap	
KSA6	0.75	1.58	0.56	#6 Str. (0.184) - #6 Str. (0.184)	#10 Sol. (0.102) - #10 Sol. (0.102)	#6 Str. (0.184) - #10 Sol. (0.102)	165
KSA4	0.81	1.38	0.62	#4 Str. (0.232) - #4 Str. (0.232)	#8 Sol. (0.129) - #10 Sol. (0.102)	#4 Str. (0.232) - #10 Sol. (0.102)	165
KSA2	0.94	1.58	0.69	#2 Str. (0.292) - #2 Str. (0.292)	#6 Sol. (0.169) - #8 Str. (0.146)	#2 Str. (0.292) - #8 Sol. (0.146)	275
KSA1/0	1.00	1.92	0.75	1/0 Str. (0.373) - 1/0 Str. (0.373)	#2 Str. Compact (0.268) - #8 Sol. (0.129)	1/0 Str. (0.373) - #8 Sol. (0.129)	385
KSA2/0	1.12	1.92	0.88	2/0 Str. (0.418) - 2/0 Str. (0.418)	#2 Str. Compact (0.268) - #8 Str. (0.146)	2/0 Str. (0.418) - #8 Str. (0.146)	385
KSA4/0	1.49	2.54	1.13	4/0 Str. (0.528) - 4/0 Str. (0.528)	#2 Str. Compact (0.268) - #6 Str. (0.184)	4/0 Str. (0.528) - #6 Str. (0.184)	500
KSA350	1.69	3.24	1.50	350 kcmil (0.681) - 350 kcmil (0.681)	1/0 Str. Compact (0.336) - #4 Str. (0.232)	350 kcmil (0.681) - #4 Str. (0.232)	650
KSA500	2.00	3.62	1.73	500 kcmil (0.813) - 500 kcmil (0.813)	400 kcmil Compact (0.659) - #2 Str. Compact (0.268)	500 kcmil (0.813) - #2 Str. Compact (0.268)	825

▲ Listed torque values are for maximum conductor combinations accommodated. Consult UL486 Tables 21, 22, 23 (found in Section O of this catalog) for smaller conductor combinations.
 ** No scratch brushing or oxide inhibiting compounds required for insulated 90° C max. rated conductor for N.E.C. applications.

TYPE KVS

OKLIP™



Copper & Copperweld

Compact, two-piece, high strength, high copper alloy BURNDY® OKLIP™ recommended for heavy duty connections. Neoprene rings hold DURIMUM™ silicon bronze bolts in place during installation. Installed with ordinary wrench.

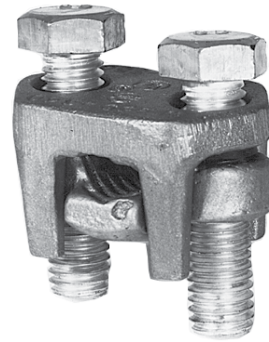

Catalog Number	Conductor					▲ Recommended Tightening Torque (in-lb)
	Copper		Copperweld			
	Run	Tap	Sol.	Str.	Type V	
KVS26	2 Str. - 2/0 Str.	6 Str. - 2/0 Str.	3/0	7 #8	—	180
KVS28	1/0 Str. - 4/0 Str.	10 Str. - 4/0 Str.	4/0	7 #6	V3/0	250
KVS31	250 - 350 kcmil	10 Str. - 350 kcmil	—	19 #8	V250	325
KVS34	400 - 500 kcmil	10 Str. - 500 kcmil	—	19 #6	V350	375
KVS40	400 - 800 kcmil	3/0 Str. - 800 kcmil	—	19 #5	—	500
KVS44	500 - 1000 kcmil	3/0 Str. - 1000 kcmil	—	—	—	500

▲ Listed torque values are for maximum conductor combinations accommodated. Consult UL486 Tables 21, 22, 23 (found in Section O of this catalog) for smaller conductor combinations.
✓ See note LIGHTNING PROTECTION INFO.

TYPE KVSU

UNIVERSAL OKLIP™



All Combinations of Copper, Aluminum, ACSR, AAAC & 5005

Compact, high strength, tin plated copper alloy two-piece connector with spacer and tin-plated silicon bronze DURIMUM™ hardware. Recommended for heavy duty connections. Spacer separates dissimilar conductors and provides long contact length. Neoprene ring prevents loss of shorter bolt during installation. Longer peened bolt permits swivel action for easier installation. Use of PENETROX™ joint compound recommended with aluminum and ACSR.

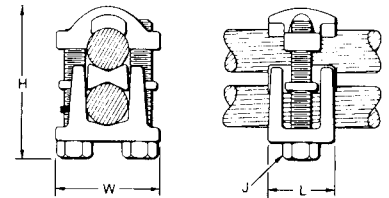

Catalog Number	Conductor								H	J	L	W	Rec. Tightening Torque (in-lb)
	Run		Tap		Run		Tap						
	Copper & Alum	ACSR, AAAC, & 5005	Copper & Alum	ACSR, AAAC, & 5005	Copper Sol., Copperweld Sol.	Steel Nom. Dia.	Copper Sol., Copperweld Sol.	Steel Nom. Dia.					
KVSU26	2 Str. - 2/0 Str.	3 - 2/0	6 Str. - 2/0 Str.	6 - 2/0	1 - 3/0	5/16 - 7/16	#6 - 3/0	3/16 - 7/16	2	5/16	1	1-1/2	180
KVSU28	1/0 Str. - 4/0 Str.	1/0 - 4/0	6 Str. - 4/0 Str.	6 - 4/0	2/0 - 4/0	3/8 - 1/2	#6 - 4/0	5/32 - 1/2	2-3/8	3/8	1-1/8	1-3/4	250
KVSU31	250 - 350 kcmil	4/0 - 300	#6 - 350	6 - 300	-	9/16 - 5/8	#6 - 4/0	3/16 - 5/8	2-5/8	1/2	1-3/8	2-1/8	325
KVSU34	400 - 500 kcmil	336.4 - 397.5	#4 - 500	5 - 397.5	-	3/4 - 3/4	#4 - 4/0	7/32 - 3/4	3	1/2	1-1/2	2-1/4	375
KVSU40	400 - 800 kcmil	4/0 - 800	4/0 - 800	3/0 - 715.5	-	3/4 - 1	-	1/2 - 1	3-1/2	1/2	1-5/8	2-1/2	500
KVSU44	500 - 1000 kcmil	4/0 - 1000	4/0 - 1000 kcmil	4/0 - 900	-	7/8 - 1 1/8	-	1/2 - 1 1/8	4	3/8	2	3	500

Accommodates compressed conductors within diameter range. ✓ See note LIGHTNING PROTECTION INFO.

TYPE KVSW

OKLIP™

Copper and Copperweld

Similar to OKLIP™ Type KVS except for a high copper alloy spacer that separates run and tap conductors. Provides high contact pressure, confines conductor strands, and assures vibration-proof connection. Longer peened bolt, permits swivel action for easier installation. Silicon bronze DURIMUM™ hardware.

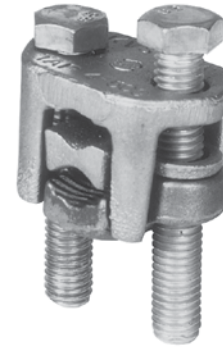

Catalog Number	Conductor		Recommended Tightening Torque (in-lb)
	Run	Tap	
KVSW26	2 Str. - 2/0 Str.	6 Sol. - 2/0 Str.	180
KVSW28	1/0 Str. - 4/0 Str.	6 Sol. - 4/0 Str.	250
KVSW31	250 - 350 kcmil	4 Sol. - 350 kcmil	325
KVSW34	400 - 500 kcmil	4 Str. - 500 kcmil	375
KVSW40	400 - 800 kcmil	AWG 4/0 - 800 kcmil	500
KVSW44	500 - 1000 kcmil	250 - 1000 kcmil	500

✔ See note LIGHTNING PROTECTION INFO.

TYPE KVS-A

ALUMINUM OKLIP™

All Combinations of Copper, Aluminum†, ACSR†, AAAC and 5005

Three-piece, high-conductivity, non-copper bearing aluminum alloy connector with thick spacer and aluminum hardware. Hardware in KVS26A and KVS28A is stainless steel. Recommended for heavy duty dissimilar metal applications. Spacer separates conductors and provides long contact length. Belled entrances prevent chafing, permit easier assembly of conductors. Longer peened bolt permits swivel action for easier installation. Neoprene ring prevents loss of shorter bolt. PENETROX™ joint compound recommended with aluminum and ACSR.

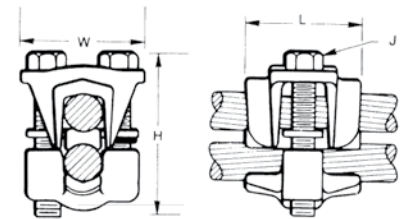

THESE CONNECTORS CAN ACCOMMODATE ACSR CONDUCTORS OVER ARMOR ROD WITHIN THE DIAMETER RANGE INDICATED.

APPLICATION OVER ARMOR ROD

Catalog Number	Conductor				Rec. Tightening Torque (in-lb)	Conductor Range by Diameter			H	J	L	W
	Run		Tap			Min. Run Dia.	Min. Tap Dia.	Max. Run & Tap Dia.				
	Copper, & Alum.†	ACSR†, AAAC, & 5005	Copper, & Alum.†	ACSR†, AAAC & 5005								
KVS26A	2 Str. - 2/0 Str.	#4 - 2/0	10 Str. - 2/0 Str.	#6 - 2/0	180	0.28	0.12	0.45	2-1/4	5/16	1-1/4	1-5/8
KVS28A	1/0 Str. - 4/0 Str.	1/0 - 4/0	10 Str. - 4/0 Str.	#6 - 4/0	240	0.36	0.12	0.56	3	3/8	1-5/8	2-1/16
KVS31A	250 - 350	4/0 - 336.4	6 Str. - 350 kcmil	#6 - 336.4 kcmil	300	0.57	0.18	0.68	3-1/16	1/2	1-15/16	2-7/16
KVS34A	400 - 500	336.4 - 397.5	4 Str. - 500 kcmil	#5 - 397.5 kcmil	300	0.73	0.22	0.81	3-9/16	1/2	2-5/16	2-5/8
KVS40A	400 - 800	336.4 - 715.5 kcmil	3/0 Str. - 800 kcmil	#3/0 - 715.5	300	0.73	0.47	1.04	4-1/16	1/2	2-7/16	2-7/8
KVS44A	500 - 1000	397.5 - 900 kcmil	3/0 Str. - 1000 kcmil	#3/0 - 900 kcmil	480	0.80	0.47	1.16	4-7/8	5/8	2-1/2	3-1/8

† Accommodates compressed conductors within diameter range. ✔ See note LIGHTNING PROTECTION INFO.

TYPE QPX

VERSITAP™



Copper, Copperweld, Copperweld-Copper

The VERSITAP™ Type QPX is recommended for Tee, Cross, Parallel, Butt and Tap connections. Range-taking, only 10 connectors required to accommodate conductor sizes from #6 Str. to 1000 kcmil. Edges are rounded for easy taping. Made of high strength, high-conductivity copper alloy and silicon bronze DURIMUM™ hardware.



* For various configurations, see page with TYPE QPX-Y

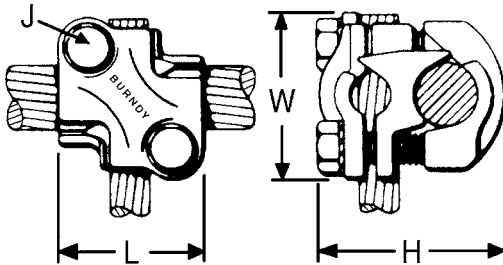

Fig. 1

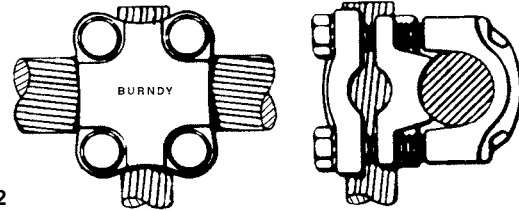

Fig. 2

Catalog Number	Copper Conductor		Fig. No.	Dimensions				Rec. Tightening Torque in-lb ▲	Conductor									
	Run	Tap		H	J	L	W		Run		Tap							
									Copperweld	Copperweld - Copper	Copperweld	Copperweld - Copper						
QPX2C2C	6 Str. - 2 Str.	6 Str. - 2 Str.	1	1-1/2	5/16	1-5/16	1-3/8	150	5 Sol. - 3 #7	8A - 4A	5 Sol. - 3 #7	8A - 4A						
QPX282C	1 Str. - 4/0 Str.	6 Str. - 2 Str.		2-1/16									3/8	1-13/16	1-13/16	250	7 #9 - 7 #5	3A - 3/0V
QPX2828	1 Str. - 4/0 Str.	1 Str. - 4/0 Str.		2-3/8	5/16	1-3/8	1-7/8											
QPX342C	250 - 500 kcmil	6 Str. - 2 Str.		2-3/4									3/8	1-3/4	2-1/16	19 #19 - 19 #6	4/0 EK	7 #9 - 7 #5
QPX3428	250 - 500 kcmil	1 Str. - 4/0 Str.			2-3/4	3/8	1-3/4											
QPX3434	250 - 500 kcmil	250 - 500 kcmil	2	3	2-1/16			2-3/16	500	19 #6	—	19 #19 - 19 #6	4/0 EK	—				
QPX442C	500 - 1000 kcmil	6 Str. - 2 Str.	1	2-11/16	5/16	1-3/8	2-1/4	19 #6							—	19 #19 - 19 #6	4/0 EK	—
QPX4428	500 - 1000 kcmil	1 Str. - 4/0 Str.		2-7/8					3/8	1-13/16	2-7/16	19 #6	—	19 #19 - 19 #6				
QPX4434	500 - 1000 kcmil	250 - 500 kcmil	2	3-1/16	3/8	2-1/16	2-9/16	19 #6							—	19 #6	—	—
QPX4444	500 - 1000 kcmil	500 - 1000 kcmil		3-7/16					2-5/8	2-9/16	2-9/16	19 #6	—	19 #6				

▲ Listed torque values are for maximum conductor combinations accommodated.
 Consult UL486 Tables 21, 22, 23 (found in Section O of this catalog) for smaller conductor combinations.
 ✓ See note LIGHTNING PROTECTION INFO.

TYPE QPX-Y

UNIVERSAL VERSITAP™

Universal Parallel Clamp For Copper and Aluminum

High copper alloy cast connector, tin-plated for use with copper or aluminum cable. Makes parallel, tap, tee, cross or end-to-end connections. Edges rounded for easy taping. PENETROX™ joint compound recommended.

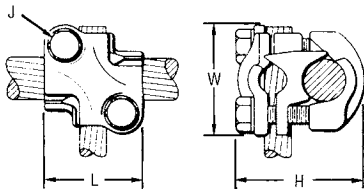
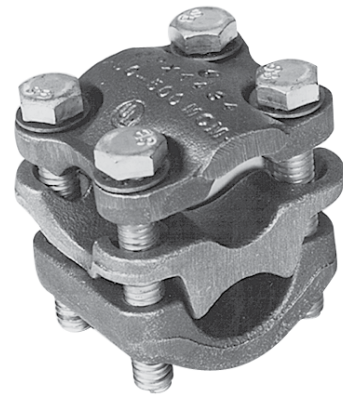

Fig. 1

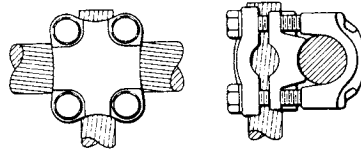

Fig. 2

Catalog Number	Run	Tap	Fig. No.	H	J	L	W	Recommended Tightening Torque in-lb ▲
QPX2C2CY	6 Str.-2 Str.	6 Str.-2 Str.	1	1-5/8	5/16	1-1/2	1-5/8	150
QPX282CY	1 Str. - 4/0 Str.	6 Str.-2 Str.	1	1-7/8	5/16	1-1/2	1-7/8	150
QPX2828Y	1 Str. - 4/0 Str.	1 Str. - 4/0 Str.	1	2	3/8	2	2-1/8	250
QPX342CY	250 - 500 kcmil	6 Str.-2 Str.	1	2-1/4	5/16	1-1/2	2-1/8	375
QPX3428Y	250 - 500 kcmil	1 Str. - 4/0 Str.	1	2-1/2	3/8	2	2-1/2	375
QPX3434Y	250 - 500 kcmil	200 - 500 kcmil	2	2-7/8	3/8	2-1/2	2-5/8	375
QPX4444Y	750 - 1000 kcmil	750 - 1000 kcmil	2	3-7/8	1/2	3-1/2	3-1/2	500

▲ Listed torque values are for maximum conductor combinations accommodated. Consult UL486 Tables 21, 22, 23 (found in Section O of this catalog) for smaller conductor combinations.
 ✓ See note LIGHTNING PROTECTION INFO.

APPLICATION VARIATIONS

PARALLEL



TAP



CROSS



SPLICE



TEE



TYPE QGFL

BARTAP™

Copper Cable to Flat Bar or Pad

High copper alloy BARTAP™ for joining a range of cable to bar or pad. One-wrench installation. DURIUM™ nut and lockwasher

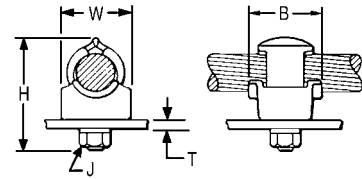

Catalog Number	Copper Conductor	B	H	J	T (Max)	W
QGFL1CB1	#10 Sol-#1 Str	1-1/8	1-7/8	3/8	1/4	1
QGFL1CB1T6	#10 Sol-#1 Str	1-1/8	2-3/8	3/8	3/4	1
QGFL26B1	#8 Sol-#2/0 Str	1-1/4	2-1/8	3/8	1/4	1-1/8
QGFL26B1T6	#8 Sol-#2/0 Str	1-1/4	2-5/8	3/8	3/4	1-1/8
QGFL26B2*	#8 Sol-#2/0 Str	1-1/4	2-5/16	1/2	1/4	1-1/8
QGFL26B2T6*	#8 Sol-#2/0 Str	1-1/2	2-13/16	1/2	3/4	1-1/8
QGFL29B1*	#6 Str-250 kcmil	1-3/8	2-5/8	1/2	1/4	1-3/8
QGFL29B1T6*	#6 Str-250 kcmil	1-5/8	3-1/8	1/2	3/4	1-3/8
QGFL31B1*	2 AWG-350 kcmil	1-3/4	2-7/8	1/2	1/4	1-5/8
QGFL31B1T6*	2 AWG-350 kcmil	1-3/4	3-1/4	1/2	3/4	1-5/8
QGFL34B1	1/0-500 kcmil	2	3-1/8	1/2	1/4	1-3/4
QGFL34B1T6	1/0-500 kcmil	2	3-5/8	1/2	3/4	1-3/4
QGFL39B1	350 kcmil-750 kcmil	2-1/4	3-1/4	1/2	1/4	1-3/4
QGFL39B1T6	350 kcmil-750 kcmil	2-1/4	3-5/8	1/2	3/4	1-3/4
QGFL44B1	750 kcmil-1000 kcmil	2-1/4	3-3/8	1/2	1/4	2-1/8
QGFL44B1T6	750 kcmil-1000 kcmil	2-1/4	4-1/8	1/2	3/4	2-1/8
QGFL46B1	1000 kcmil-1500 kcmil	2-1/4	4	1/2	1/4	2-1/2
QGFL46B1T6	1000 kcmil-1500 kcmil	2-1/4	4-1/2	1/2	3/4	2-1/2
QGFL48B1	1500 kcmil-2000 kcmil	2-1/4	4-3/4	1/2	1/4	3

* Can be installed side by side or in-line on NEMA drilled bar.

TYPE FCB

TRANSFORMER TAP ADAPTER

Copper and Aluminum

Cast in one piece from copper alloy. Transformer tap adapter designed to accommodate from 1 to 6 NEMA drilled copper or aluminum terminal taps from a single secondary transformer outlet. Tin-plated. Order mounting hardware and tap terminals separately.

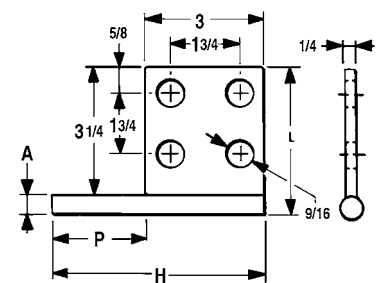

Fig. 1

Catalog Number	Fig. No.	A Diameter	H Ref.	L	P
FCB634N	1	0.50	5.25	3.75	2.25
FCB636N	2	0.50	5.25	5.50	2.25
FCB644N	1	0.75	5.75	4.00	2.75
FCB646N	2	0.75	5.75	5.75	2.75
FCB654N	1	1.00	7.00	4.25	4.00
FCB632NP300	Not Shown	0.50	5.00	3.50	3.00
FCB6444NP50	Not Shown	0.75	9.00	5.00	5.00

NOTE: All pads are NEMA drilled.

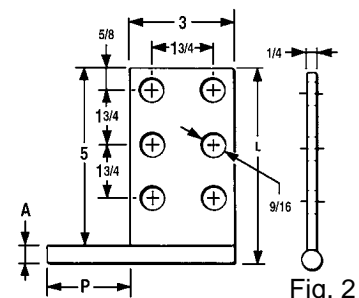

Fig. 2

TYPE BIPC

Continued

Features & Benefits

- Flexibility! One connector allows for tap, splice or dead-end configurations
- Time Savings! Requires no cable stripping, conductor brushing, inhibitor application or after installation taping
- Engineered shear bolt technology applies consistent torque for efficient and reliable connectors
- Easy installation and removal - only requires 6-point socket impact driver
- cULus Listed Splicing Wire Connector, AL9CU Rated, for copper and aluminum conductor combinations up to 90°C, *600 Volt applications
- Insulation piercing design for use in multiple applications - overhead covered and bare taps, service and metering connections, and lighting system work
- Range taking design reduces the number of SKUs necessary to cover from #14 AWG up to 750 kcmil

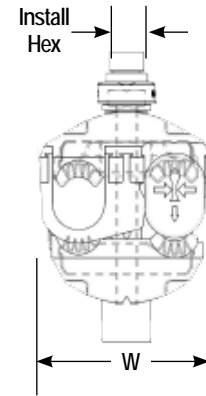
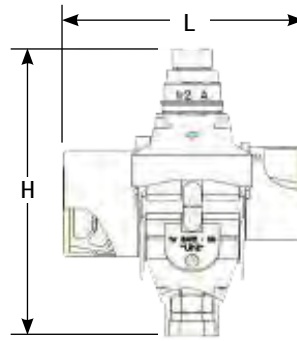

Catalog Number	Conductor Range		Figure	Install Hex Socket	H	L	W
	Run	Tap					
BIPC1/010SC	#8 - 1/0	#10 - #2	1	1/2	3.70	3.00	2.00
BIPC1/08SC	#8 - 1/0	#8 - 1/0	1	1/2	3.70	3.00	2.00
BIPC2/014S	#6 - 2/0	#14 - #8	1	1/2	2.87	2.16	1.54
BIPC4/010S	#3 - 4/0	#10 - #2	1	1/2	3.66	2.76	1.73
BIPC2504SC	#1 - 250	#4 - 4/0	1	1/2	4.09	3.46	2.64
BIPC50010SC*	3/0 - 500	#10 - #2	1	1/2	4.09	2.20	2.40
BIPC75014	3/0 - 750	#14 - #10	1	1/2	4.13	2.76	2.40
BIPC3501/0SC	1/0 - 350	1/0 - 350	2	5/8	5.16	5.04	3.11
BIPC5004SC	2/0 - 500 (750**)	#4 - 4/0	2	5/8	5.28	5.04	3.11
BIPC5001/0S	4/0 - 500	1/0 - 350	2	5/8	5.28	5.04	2.91
BIPC5004/0SC*	4/0 - 500	4/0 - 500	2	5/8	5.47	5.75	3.58
BIPC7502SC*	250 - 500 (750**)	#2 - 4/0	2	5/8	5.47	5.75	3.58
BIPC750250SC	250 - 500 (750**)	250 - 500	2	5/8	5.47	5.75	3.58

* Not cULus Listed

**Max run conductor size can only be achieved in TAP orientation with end cap removed

BURNDY Catalog Numbers with suffix S come with red spacer component, to be left in

BURNDY Catalog Numbers with suffix SC come with red spacer component as well as end caps installed; end caps can be rearranged to meet install requirements (tap, splice, or dead-end)

TYPE BIPC

Insulation Piercing Connector for Copper and Aluminum

UL Listed 90° C, *600 Volt

The Type BIPC, BURNDY® Insulation Piercing Connector is ideally suited for splicing and tapping aluminum and copper conductor wire sizes: #10 AWG to 500 kcmil.



Features & Benefits

- Insulation piercing capability eliminates the need for insulation stripping
- UL486B Listed, AL9CU Rated, for copper and aluminum conductor combinations up to 90°C, *600 Volt applications
- Insulation piercing design for use on hot-line applications eliminates the need for taping
- Easy snap-out tabs eases installation and protects connection from dirt and debris
- Simple bolt-on connection for ease of installation

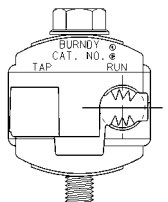
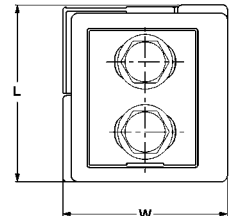
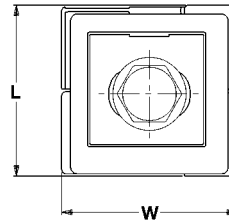

Typical View Showing Breakaway Tab

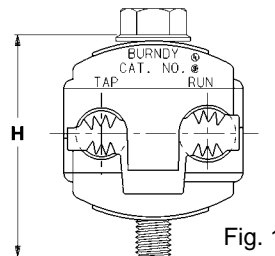

Fig. 1

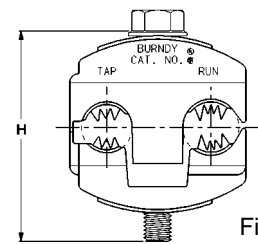

Fig. 2

Catalog Number	Conductor Range		Bolt Size	Socket Size	H	L	W	Recommended Tightening Torque	Max. Voltage Rating
	Run	Tap							
BIPC1/02*	1/0 - 8 AWG	2 - 8 AWG	5/16	1/2	2.00	1.53	1.53	180	600 V
BIPC4/06	4/0 - 1/0 AWG	1/0 - 6 AWG	5/16	1/2	2.50	2.12	2.00	250	300 V
BIPC4/01/0	4/0 - 1/0 AWG	4/0 - 1/0 AWG	5/16	1/2	2.50	2.12	2.06	250	300 V
BIPC3504/0	350 - 4/0 AWG	4/0 - 10 AWG	3/8	9/16	3.00	1.59	2.50	375	300 V
BIPC350350	350 - 4/0 AWG	350 - 4/0 AWG	3/8	9/16	3.00	2.62	2.75	300	300 V
BIPC5004/0*	500 - 350 kcmil	4/0 - 4 AWG	3/8	9/16	3.25	1.80	2.62	400	600 V

* 600 Volt

TYPE KPA

SCRULUG™

Copper Cable

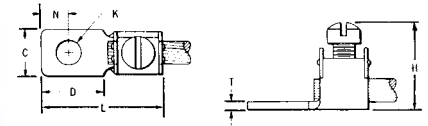

Fig. 1

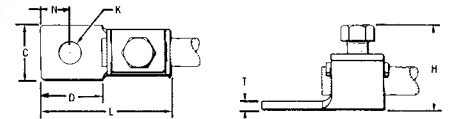

Fig. 2

High copper alloy tin-plated terminal for joining a wide range of cable to equipment pads or terminal blocks. Especially good in light industrial applications. The tongue and body are a one-piece design. The pressure bar equalizes pressure over the conductor and prevents the screw from cutting into the cable

Catalog Number	Wire Range	Fig. No.	C	D	H	K	Stud Hole Size	L	N	T	Recommended Tightening Torque (in-lb)
KPA8C	14 Sol. - 8 Str.	1	0.38	0.47	0.72	0.21	#10	0.97	0.22	0.06	25
KPA4C	14 Sol. - 4 Str.	1	0.50	0.59	0.94	0.27	1/4	1.22	0.30	0.06	35
KPA25	4 Str. - 1/0 Str.	2	0.75	0.81	1.25	0.33	5/16	1.82	0.41	0.10	180
KPA28	1/0 Str. - 4/0 Str.	2	0.97	1.12	1.66	0.39	3/8	2.40	0.53	0.13	250
KPA34	4/0 Str. - 500 kcmil	2	1.38	1.38	2.44	0.54	1/2	3.32	0.75	0.20	375

NOTE: For unplated version add "UNPL" suffix.

TYPE KPA-UP

SCRULUG™

Copper Cable

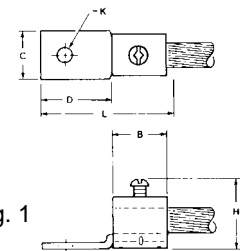
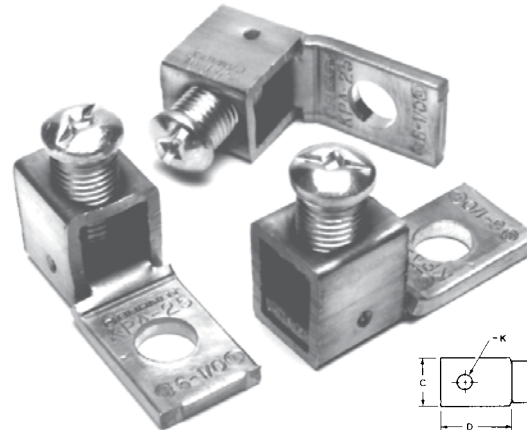

Fig. 1

High copper alloy terminal for joining a wide range of cable to equipment pads or terminal blocks. Plain copper finish.

Features & Benefits

- One piece design for superior torque and pull out performance
- Convenient range taking design reduces number of SKUs needed to carry in stock; one catalog number accommodates several conductor sizes
- High conductivity copper alloy for a long lasting, reliable connection
- Compact, easy to use design
- Slot Robertson screw, hex head, hex socket bolt require no special installation tools and eliminates over-torquing and potential conductor damage

Catalog Number	Wire Range	Fig. No.	C	D	H	K	Stud Hole Size	L	N	T	Hardware	Recommended Tightening Torque (in-lb)
KPA8CUP	14 Sol. - 6 Str.	1	0.38	0.56	0.81	0.20	#10	1.04	0.22	0.07	# 12-24 SLOT	35
KPA4CUP	14 Sol. - 4 Str.		0.50	0.71	1.00	0.28	1/4	1.28	0.33		5/16 DIA.SLOT ROBERTSON	45

NOTE: For tin plating drop "-UP" suffix and add "-TP" suffix (example: KPA4CTP). For use in grounding applications with a green screw, contact factory. Listed for grounding per UL467.

TYPE KLU

SCRULUG™



Copper Cable with Offset Tongue; Non-Plated

High copper alloy terminal with offset tongue for joining a wide range of cable to equipment pads or bar. Easy to install with screwdriver or wrench. Connector is reusable. Plain copper finish.

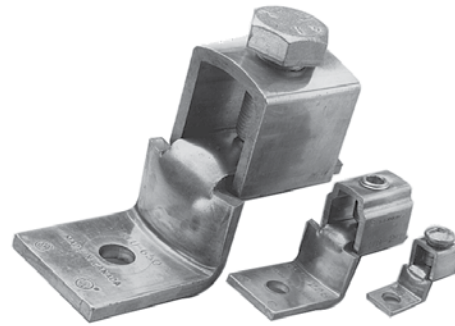

Features & Benefits

- Convenient range-taking design reduces catalog numbers required in inventory; one connector accommodates several conductor sizes
- High conductivity copper alloy for long lasting reliable contact
- Compact design, easy to install, reduces labor time
- Slot Robertson screw, hex head, hex socket bolt require no special installation tools and eliminates over-torquing and potential conductor damage

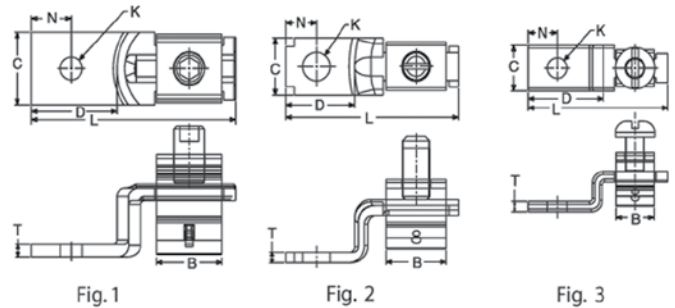

① Catalog Number	Conductor	Fig. No.	B (MM/IN)	C (MM/IN)	K (MM/IN)	L (MM/IN)	N (MM/IN)	T (MM/IN)	Rec. Tightening Torque (in-lb)	Hardware	Stud Hole Size	Strip Length (in)
KLU25	14 Sol. .064 Dia. to 10 Sol. .102 Dia. CU	3	7.00 0.28	8.00 0.31	4.00 0.14	26.0 1.02	5.00 0.21	2.00 0.07	20	No. 8-32 Slotted Round Machine Screw	#6	7/16
KLU25TP												
KLU35	14 Sol. .0641 Dia. to 6 Str. .184 Dia. CU	2	11.0 0.43	10.0 0.39	5.00 0.20	31.0 1.24	6.00 0.22	2.00 0.07	35	1/4 UNF Slotted Set Screw	#10	5/8
KLU35TP												
KLU70	8 Sol. .129 Dia. to 2 Str. .292 Dia. CU	2	13.0 0.50	12.0 0.47	7.00 0.26	39.0 1.55	6.00 0.25	2.00 0.08	40	5/16 UNF Slotted Set Screw	1/4	3/4
KLU70TP												
KLU125	2 Str. .292 Dia. to 1/0 Str. .372 Dia. CU	2	15.0 0.61	16.0 0.62	7.00 0.26	50.0 1.98	11.0 0.42	3.00 0.11	50	3/8 UNF Slotted Set Screw	1/4	15/16
KLU125TP												
KLU175	4 Str. .232 Dia. to 3/0 Str. .470 Dia. CU	1	18.0 0.72	19.0 0.75	10.0 0.39	56.0 2.20	11.0 0.43	4.00 0.16	250	3/8 UNF Socket/Hex Screw	3/8	1
KLU175TP												
KLU225	2 Str. .292 Dia. to 4/0 Str. .528 Dia. CU	1	24.0 0.94	25.0 0.99	9.00 0.34	65.0 2.55	13.0 0.51	3.00 0.12	250	7/16 UNF Socket/Hex Screw	5/16	1-5/16
KLU225TP												
KLU300	1/0 Str. .372 Dia. to 350 kcmil. .681 Dia. CU	1	31.0 1.22	25.0 0.99	10.0 0.39	72.0 2.83	13.0 0.52	3.00 0.12	325	5/8 UNF Socket/Hex Screw	3/8	1-5/8
KLU300TP												
KLU400	1/0 Str. .372 Dia. to 500 kcmil. .813 Dia. CU	1	36.0 1.42	38.0 1.50	10.0 0.39	104.0 4.09	23.0 0.91	5.00 0.18	375	5/8 UNF Socket/Hex Screw	3/8	1-5/32
KLU400TP												

NOTES:

- ① Suffix "-TP" on catalog number denotes tin plate (example: KLU400TP).
- 2 Material: Copper alloy.

TYPE KA

KA-LUG™

Copper Cable



Compact, economical, high copper alloy terminal for joining a wide range of cable to equipment pads or terminal blocks.

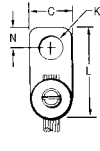

Fig. 1

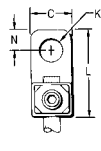

Fig. 2

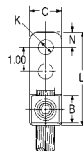

Fig. 3



Catalog Number	Conductor	Fig. No.	C	H	J	K	Stud Hole Size	L	N	T	Recommended Tightening Torque (in-lb)
KA8C	# 14 Sol. (0.064 Dia.) - 8 Str. (0.416 Dia.)	1	3/8	5/8	#12	7/32	#10	13/16	3/16	3/32	25
KA4C	# 14 Sol. (0.064 Dia.) - 4 Str. (0.232 Dia.)	1	9/16	3/4	5/16"	9/32	1/4	1-1/8	1/4	7/64	45
KA25*	# 4 Str. (0.232 Dia.) - 1/0 Str. (0.373 Dia.)	2	3/4	15/16	1/2"	27/64	3/8	1-11/16	3/8	1/8	200
KA252TC38*	# 4 Str. (0.232 Dia.) - 1/0 Str. (0.373 Dia.)	3	3/4	15/16	1/2"	27/64	3/8	2-13/16	3/8	1/8	200
KA28*	# 1 Str. (0.332 Dia.) - 4/0 Str. (0.528 Dia.)	2	15/16	1-1/4	5/8"	27/64	3/8	1-15/16	7/16	3/16	275
KA34*	4/0 Str. (0.528 Dia.) - 500 kcmil (0.814 Dia.)	2	1-3/8	2-3/32	13/16"	9/16	1/2	2-9/16	9/16	9/32	375

▲ Listed torque values are for maximum conductor combinations accommodated.
Consult UL486 Tables 21, 22, 23 (found in Section O of this catalog) for smaller conductor combinations.
* Not CSA Certified

TYPE EA

VERSILUG™

Copper Cable

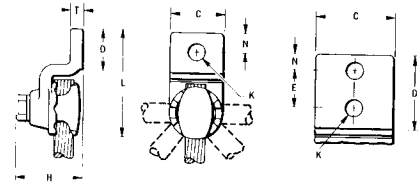

Compact, high copper alloy terminal for joining a wide range of cable to equipment pads or bar. Clamping element adjustable to several angles. One-wrench installation.

Catalog Number	Wire Range	No. of holes in pad	C	D	E	H	K	Stud Hole Size	L	N	T	Rec. Tightening Torque (in-lb)
EA2C	8 AWG-2 AWG	1	13/16	1-1/16	—	1-3/8	7/16	3/8	2-1/2	13/32	1/4	150
EA25	2 AWG-1/0	1	7/8	1-1/8	—	1-7/16	7/16	3/8	2-11/16	7/16	1/4	180
EA28	1/0 -4/0 AWG	1	1-1/16	1-3/8	—	1-3/4	7/16	3/8	3-3/16	17/32	5/16	250
EA282N	1/0 -4/0 AWG	2	1-1/16	3-5/8	1-3/4	1-3/4	9/16	1/2	5-1/8	5/8	5/16	250
EA34	250 kcmil-500 kcmil	1	1-3/8	1-5/8	—	2-1/4	9/16	1/2	4	13/16	3/8	375
EA342N	250 kcmil-500 kcmil	2	1-3/8	3-5/8	1-3/4	2-1/4	9/16	1/2	5-5/8	5/8	3/8	375

* "N" indicates NEMA standard stud holes.
▲ Listed torque values are for maximum conductor combinations accommodated.
Consult UL486 Tables 21, 22, 23 (found in Section O of this catalog) for smaller conductor combinations.

TYPES QA, QQA

QIKLUG™

Copper Cable



Type QA

Type QA heavy duty, compact, high copper alloy terminal for joining a wide range of cable to equipment pads or bar. Fast one-wrench installation. Type QQA heavy duty, high copper alloy terminal for joining cable to equipment pads or bar. Twin clamping elements secure joint vibration and flexing. One-wrench installation.

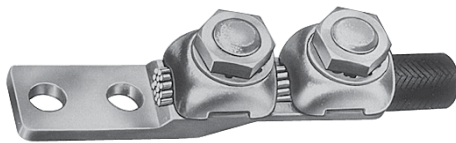

Type QQA

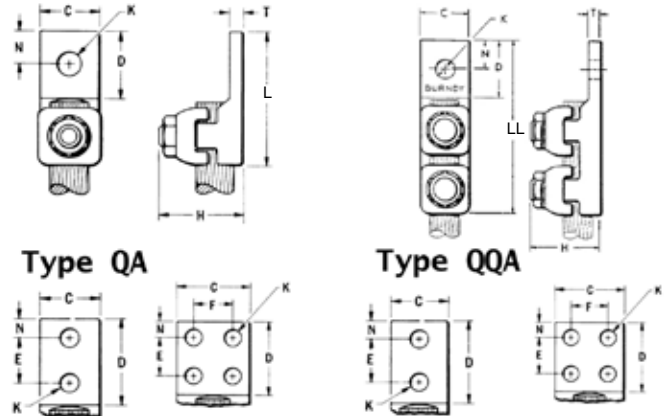

Catalog Number*		Conductor		Holes in Pad	C	D	E & F	H	K	Stud Hole Size	L	LL	N	T	Torque (in-lb)
Type QA	Type QQA	Commercial	Navy												
QA8CB	QQA8C	14 Sol. - 8 Str.	4-14	1	9/16	9/16	—	11/16	7/32	#10	1-3/8	2-5/16	9/32	5/32	75
QA8C2B	—	14 Sol. - 8 Str.	4-14	2	9/16	1-1/4	5/8	11/16	7/32	#10	2	3	5/16	5/32	75
QA4CB	—	8 Str. - 4 Str.	23-40	1	5/8	5/8	—	3/4	9/32	1/4	1-7/16	2-3/8	5/16	3/16	110
QA4C2B	QQA4C2	8 Str. - 4 Str.	23-40	2	5/8	1-3/16	5/8	3/4	9/32	1/4	2	2-15/16	5/16	3/16	110
QA1CB	QQA1C	4 Str. - 1 Str.	50-75	1	5/8	3/4	—	1	9/32	1/4	1-3/4	2-13/16	11/32	7/32	150
QA1C2B	QQA1C2	4 Str. - 1 Str.	50-75	2	5/8	1-9/16	7/8	1	11/32	5/16	2-9/16	3-5/8	11/32	7/32	150
QA26B	QQA26	1/0 Str. - 2/0 Str.	100-125	1	13/16	1	—	1-3/16	13/32	3/8	2	3-3/16	7/16	7/32	180
QA262B	QQA262	1/0 Str. - 2/0 Str.	100-125	2	13/16	1-15/16	1	1-3/16	13/32	3/8	3	4-3/16	7/16	7/32	180
QA28B	QQA28	3/0 Str. - 4/0 Str.	150-200	1	1	1-1/16	—	1-5/16	13/32	3/8	2-1/4	3-9/16	17/32	1/4	250
QA282B	—	3/0 Str. - 4/0 Str.	—	2	1	2	1	1-9/29	13/32	3/8	3-1/5	—	7/16	1/4	250
QA282N*	QQA282N*	3/0 Str. - 4/0 Str.	150-200	2	1	3-1/8	1-3/4	1-5/16	9/16	1/2	4-5/16	5-5/8	5/8	1/4	250
QA31B	QQA31	250 - 350 kcmil	250-350	1	1-3/16	1-3/8	—	1-11/16	17/32	1/2	2-11/36	4-1/8	11/16	5/16	325
QA312B	—	250 - 350 kcmil	250-350	2	1-3/16	1-31/32	1	1-11/16	7/16	3/8	3-3/8	—	7/16	5/16	325
QA312N	QQA312N*	250 - 350 kcmil	250-350	2	1-3/16	3	1-3/4	1-11/16	9/16	1/2	4-7/16	5-7/8	5/8	5/16	325
QA34B	—	400 - 500 kcmil	400-500	1	1-3/8	1-5/8	—	2	17/32	1/2	3-3/16	4-7/8	13/16	5/16	375
QA342B	—	400 - 500 kcmil	400-500	2	1-3/8	2	1	2	13/32	3/8	3-9/16	—	7/16	5/16	375
QA344B	QQA34	400 - 500 kcmil	400-500	4	1-7/8	1-15/16	1	2	7/16	3/8	3-1/2	—	7/16	5/16	375
QA342N*	QQA342N*	400 - 500 kcmil	400-500	2	1-3/8	3-3/32	1-3/4	2	9/16	1/2	4-11/16	6-9/32	5/8	5/16	375
QA40B	—	600 - 800 kcmil	650-800	1	1-5/8	1-7/8	—	2-7/16	11/16	5/8	3-11/16	—	27/32	3/8	500
QA402N*	QQA402N*	600 - 800 kcmil	650-800	2	1-5/8	3	1-3/4	2-7/16	9/16	1/2	4-14/16	7-3/32	5/8	3/8	500
QA44B	—	850 - 1000 kcmil	1000	1	1-7/8	2	—	2-3/4	11/16	5/8	3-15/16	—	1	1/2	500
QA442N*	QQA442N*	850 - 1000 kcmil	1000	2	1-7/8	3	1-3/4	2-3/4	9/16	1/2	5	7-1/8	5/8	1/2	500
QA444N*	QQA444N*	850 - 1000 kcmil	1000	4	3	3-1/16	1-3/4	2-3/4	9/16	1/2	5	7-1/8	5/8	1/2	500
QA462N*	—	1100 - 1500 kcmil	1300	2	2-1/8	3	1-3/4	3-1/8	9/16	1/2	5-1/4	—	5/8	9/16	600
QA46B	—	1100 - 1500 kcmil	1300	1	2-1/8	2-1/8	—	3-1/8	13/16	3/4	4-3/8	—	1-1/16	9/16	600

* "N" indicates NEMA standard stud holes.

⚡ All 4N items see note LIGHTNING PROTECTION INFO.

TYPE Q2A

QIKLUG™



Copper Cable

Compact, high copper alloy terminal for joining two cables to equipment pads or bars. Each element accommodates a wide range of cable. One-wrench installation.

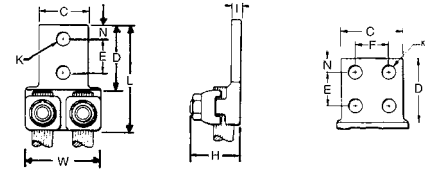

Catalog Number*	Conductor	No. of Holes in Pad	C	D	E & F	H	K	Stud Hole Size	L	N	T	W	Recommended Tightening Torque in-lb
Q2A1C2	4 Str. - 1 Str.	2	1-1/2	1-7/8	1	1-1/16	7/16	3/8	2-7/8	7/16	7/32	1-13/16	150
Q2A262N	1/0 Str. - 2/0 Str.		1-5/8	3-1/8	3/4	1-3/16	9/16	1/2	4-3/16	5/8	1/4	1-15/16	180
Q2A282N	3/0 Str. - 4/0 Str.	1-7/8	1-3/8		4-3/8	2-1/8			250				
Q2A284N		4	3		4-1/2	5/16			325				
Q2A312N	250 - 350 kcmil	2	2-3/8		1-11/16	3			375				
Q2A314N		4	3		2	3-3/4			500				
Q2A342N	400 - 500 kcmil	2	2-1/2		2-7/16	5			500				
Q2A344N		4	3		4-11/16	3/8			3-3/4			375	
Q2A402N	600 - 800 kcmil	2	3		2-3/4	5			500				
Q2A404N		4	3		4-11/32	7/16			500				
Q2A444N	850 - 1000 kcmil	4	3-1/4		2-3/4	5-1/4			500				
Q2A464N	1100 - 1500 kcmil		3-1/2	3-1/4	3-1/8	5-1/2	600						

* "N" indicates NEMA standard stud holes.

~ All 4N items see note LIGHTNING PROTECTION INFO.

TYPE Q3A

QIKLUG™

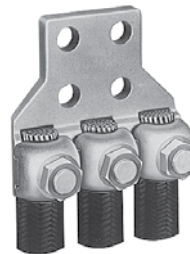

Copper Cable

Compact, high copper alloy terminal for joining three cables to equipment pads or bar. Each element accommodates a wide range of cable. One-wrench installation.

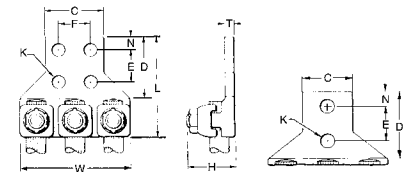

Catalog Number*	Conductor	No. of Holes in Pad	C	D	E & F	H	K	Stud Hole Size	L	N	T	W	Recommended Tightening Torque in lb			
Q3A282N	3/0 Str. - 4/0 Str.	2	1-7/8	3-1/8	1-3/4	1-3/8	9/16	1/2	4-5/16	5/8	1/4	3-3/16	250			
Q3A284N	3/0 - 4/0 Str.	4	3						4-3/8					500		
Q3A312N	250 - 350 kcmil	2	2-3/8						4-7/16					5/16	4-1/16	325
Q3A314N		4	3						1-11/16					4-3/4	3/8	4-9/16
Q3A342N	400 - 500 kcmil	2	2-1/2						1-15/16					5	500	
Q3A344N		4	3						2-7/16					7/16	5-13/16	500
Q3A404N	600 - 800 kcmil	4	3						2-3/4					5-1/4	500	
Q3A444N	850 - 1000 kcmil		3-1/4						2-3/4					5-1/2	1/2	6-5/8
Q3A464N	1100 - 1500 kcmil	4	3-1/2						3-1/4					3-1/8	5-1/2	600

* "N" indicates NEMA standard stud holes.

TYPE QB

QIKLUG™

Copper Cable

Compact, high copper alloy side entrance terminal for joining a range of cable at right angles to terminal blocks. One-wrench installation.

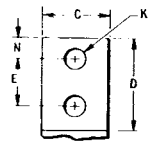
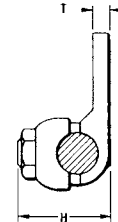
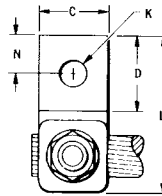
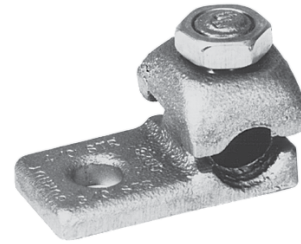

Catalog Number*	Conductor	No. of Holes in Pad	C	D	E	H	K	Stud Hole Size	L	N	T	Recommended Tightening Torque in-lb
QB8C	14 Sol. - 8 Str.	1	9/16	9/16	—	7/8	7/32	#10	1-1/8	9/32	5/32	75
QB4C	8 Str. - 4 Str.	1	11/16	27/32	—	13/16	9/32	1/4	1-3/8	11/32	1/4	110
QB1C	4 Str. - 1 Str.	1	11/16	13/16	—	1	9/32	1/4	1-1/2	11/32	7/32	150
QB26	1/0 Str. - 2/0 Str.	1	13/16	1	—	1-1/32	13/32	3/8	1-13/16	7/16	7/32	180
QB28	3/0 Str. - 4/0 Str.	1	1	1-1/16	—	1-5/16	13/32	3/8	2-1/16	17/32	1/4	250
QB312N	250 - 350 kcmil	2	13/16	3-1/4	1-3/4	1-11/16	9/16	1/2	4-1/2	5/8	5/16	325

* "N" indicates NEMA standard stud holes.

TYPE Q2B

QIKLUG™

Copper Cable

Compact, high copper alloy terminal for joining two cables at right angles to a single terminal block. Each element accommodates a range of cable. One-wrench installation.

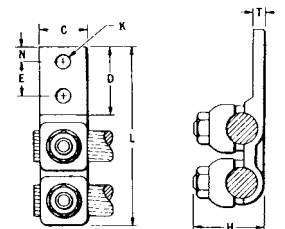
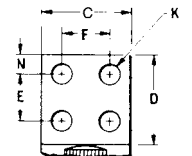

Catalog Number*	Conductor	No. of Holes in Pad	C	D	E & F	H	K	Stud Hole Size	L	N	T	Recommended Tightening Torque in-lb
Q2B282N	3/0 Str. - 4/0 Str.	2	1-7/8	3-1/8	1-3/4	1-3/8	9/16	1/2	5-3/16	5/8	1/4	250
Q2B312N	250 - 350 kcmil	2	2-3/8	3-3/16	1-11/16	1-3/8	9/16	9/16	5-7/8	5/8	5/16	325
Q2B404N	600 - 800 kcmil	4	3	3-1/16	1-3/8	2-5/16	9/16	3/4	6-11/16	5/8	7/16	500

* "N" indicates NEMA standard stud holes.

⚡ All 4N items see note LIGHTNING PROTECTION INFO.

TYPE QDA

QIKLUG™

Copper Cable

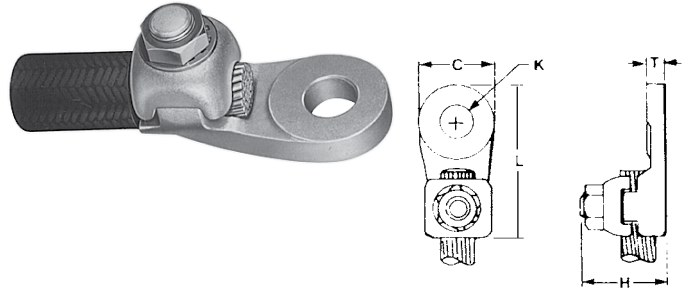

Compact, high copper alloy terminal for joining a wide range of cable to equipment studs. Provides low contact resistance when gripped between two contact nuts. One wrench installation.

Catalog Number	Conductor		C	H	K	Stud Hole Size	L	T	Recommended Tightening Torque in-lb
	Commercial	Navy							
QDA8C	14 Sol. - 8 Str.	3 - 14	1	11/16	7/16	3/8	1-7/8	3/16	75
QDA4C	8 Str. - 4 Str.	23 - 40	1	3/4	7/16	3/8	1-7/8	7/32	110
QDA1C	4 Str. - 1 Str.	50 - 75	1	1	7/16	3/8	2-3/16	9/32	150
QDA26	1/0 Str. - 2/0 Str.	100 - 125	1-1/4	1-3/16	9/16	1/2	2-1/2	5/16	180
QDA28	3/0 Str. - 4/0 Str.	150 - 200	1-1/4	1-5/16	9/16	1/2	2-5/8	5/16	250
QDA31	250 - 350 kcmil	250 - 350	1-1/2	1-11/16	11/16	5/8	3	5/16	325
QDA34	400 - 500 kcmil	400 - 500	1-7/8	2	13/16	3/4	3-5/8	5/16	375
QDA40	600 - 800 kcmil	650 - 800	2-1/8	2-5/16	1-1/16	1	4-3/16	3/8	500

TYPE QR

QIKLINK™ SPLICE OR REDUCER

Copper Cable to Cable

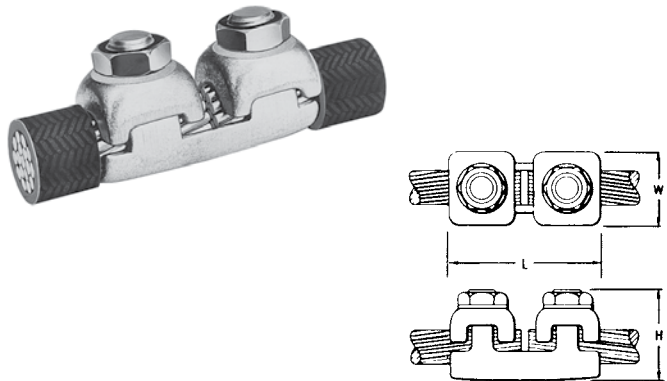

High copper alloy splicer/reducer for joining a range of cable end to end. Neat, compact easy to tape installation. One-wrench installation.

Catalog Number	Conductor Either Side	H	L	W	Recommended Tightening Torque in-lb
QR4C	6 Sol. - 4 Str.	3/4	1-11/16	5/8	110
QR1C	4 Str. - 1 Str.	1-1/16	1-15/16	11/16	150
QR26	1/0 Str. - 2/0 Str.	1-3/16	2-1/8	13/16	180
QR28	3/0 Str. - 4/0 Str.	1-3/8	2-3/8	1	250
QR31	250 - 350 kcmil	1-11/16	2-5/8	1-1/4	325
QR34	400 - 500 kcmil	1-15/16	3-1/16	1-7/16	375
QR40	600 - 800 kcmil	2-7/16	3-5/8	1-7/8	500

See note LIGHTNING PROTECTION INFO.

TYPES VA, VVA

VARILUG™



Copper Cable

High copper alloy terminal for joining a wide range of cable to equipment pads or bar. Particularly suitable for use on extra flexible cable. One-wrench installation. Type VVA, twin elements secure joint against vibration and flexing. Particularly recommended for use on extra flexible cables. One-wrench installation.

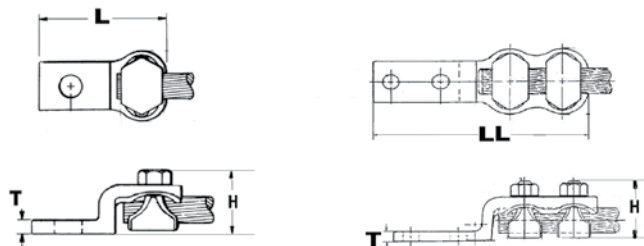

Type VA

Type VVA

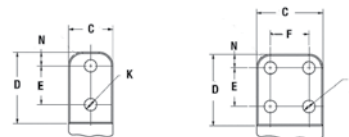

Catalog Number*		Conductor	No. of Holes in Pad	C	D	E&F	H	K	Stud Hole Size	L	LL	N	T	Rec. Tightening Torque
Type VA	Type VVA													
VA2C	VVA2C	8 AWG-2 AWG	1	13/16	1-1/4	—	1-1/2	7/16	3/8	2-3/4	4-1/16	13/32	1/4	275
VA25	VVA25	6 AWG-1/0	1	7/8	1-5/16	—	1-7/8	7/16	3/8	2-7/8	4-5/16	7/16	1/4	385
VA28	VVA28	1/0 -4/0 AWG	1	1-1/16	1-1/2	—	2-1/4	7/16	3/8	2-7/8	4-1/8	17/32	5/16	250
VA282N	VVA282N	1/0 -4/0 AWG	2	1-1/16	3-1/2	1-3/4	2-1/4	9/16	1/2	4-15/16	6-1/5	5/8	5/16	250
VA30	VVA30	1/0 -300 kcmil	1	1-1/8	1-5/8	—	2-3/16	7/16	3/8	3-1/4	4-5/8	5/8	5/16	325
VA302N	VVA302N	1/0 -300 kcmil	2	1-1/8	3-9/16	1-3/4	2-3/16	9/16	1/2	5-3/16	6-9/16	5/8	5/16	325
VA34	VVA34	300 kcmil-500 kcmil	1	1-3/8	2	—	3-11/32	9/16	1/2	3-13/16	5-5/16	13/16	3/8	375
VA342N	VVA342N	300 kcmil-500 kcmil	2	1-3/8	3-5/8	1-3/4	3-11/32	9/16	1/2	5-3/8	6-7/8	5/8	3/8	375
VA344N	VVA344N	300 kcmil-500 kcmil	4	3	3-5/8	1-3/4	3-11/32	9/16	1/2	5-3/8	6-7/8	5/8	3/8	375
VA40	VVA40	500 kcmil-800 kcmil	1	1-5/8	2-5/16	—	2-7/8	11/16	5/8	4-1/2	6-3/8	15/16	3/8	500
VA402N	VVA402N	500 kcmil-800 kcmil	2	1-5/8	3-5/8	1-3/4	2-7/8	9/16	1/2	5-13/16	7-11/16	5/8	3/8	500
VA404N	VVA404N	500 kcmil-800 kcmil	4	3	2-5/8	1-3/4	2-7/8	9/16	1/2	5-13/16	7-11/16	5/8	3/8	500

* "N" indicates NEMA standard stud holes.

✓ All 4N items see note LIGHTNING PROTECTION INFO.

TYPE CL501 & CL501TN

COPPER LAY-IN QIKLUG™

Copper

The Lay-In QIKLUG™ is manufactured from high strength pure electrolytic copper to ensure maximum strength and conductivity. UL467 Listed for direct burial in earth or concrete. The open-faced design allows for fast lay-in of the conductor without the need for cutting or breaking. Stainless steel screws used for excellent corrosion resistance.

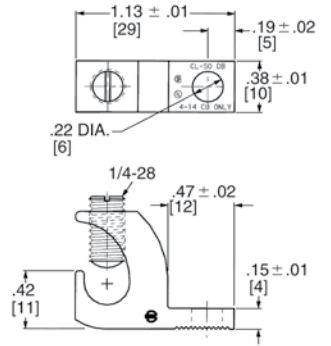

Catalog Number	Conductor Range	Stud Hole
CL501	14 AWG-4 AWG	#10
CL501TN	14 AWG-4 AWG	#10

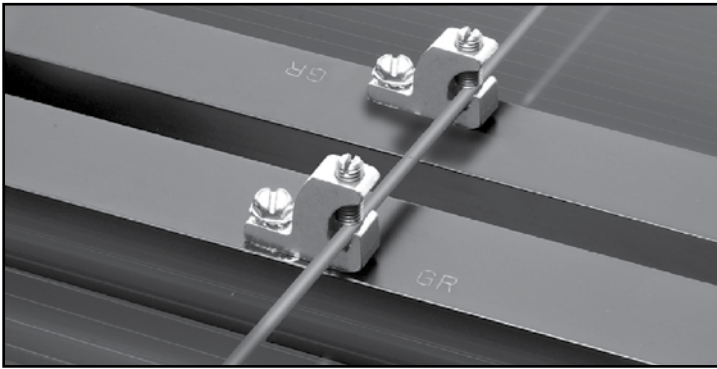

Photo above shows a typical solar panel installation using CL50-1 connectors.



TYPE CL

COPPER LAY-IN QIKLUG™

Copper



Manufactured for maximum strength and conductivity, these lay-in lugs allow for continuous runs of conductor and are well suited as terminations as well. Tin-plated, set screw style connectors, three sizes cover a range from #14AWG to 250 kcmil. CL3/0-516TN and CL250-516TN are UL Listed and CSA certified. CL1/0-14TN UL Listed for grounding and CSA Certified. 90° C rated. Suitable for copper conductors only.

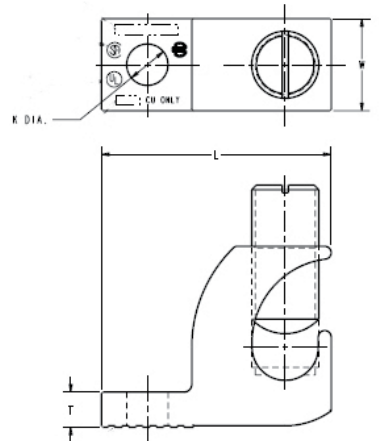

Catalog Number	Wire Range Copper	H	W	L	T	K Dia	Hex Size
CL1/014TN	#14 - 1/0 AWG	1.17	0.60	1.50	0.22	0.27	7/16-20 (Slotted)
CL3/0516TN	#6 - 3/0 AWG	1.56	0.80	2.00	0.30	0.33	9/16-18 (0.25 Hex)
CL250516TN	#6 AWG - 250 kcmil	1.79	0.80	2.20	0.30	0.33	9/16-18 (0.25 Hex)

TYPE BGBL

LAY-IN QIKLUG™

UL LISTED 90° C, 600 V

The Lay-In QIKLUG™, Type BGBL is manufactured from high strength 6061-T6 aluminum, and is ideally suited for grounding and bonding applications accommodating both copper and aluminum conductor sizes #14 AWG to 250 kcmil. The BGBL4SS with Stainless Steel screw is UL 467 Listed for grounding and bonding.

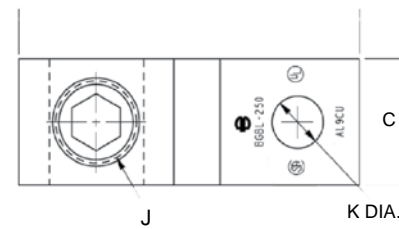
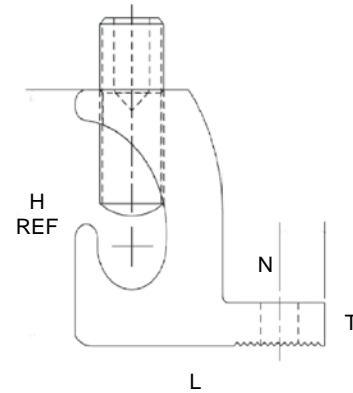

Features & Benefits

- UL 486B Listed, AL9CU Rated for copper and aluminum conductor combinations up to 90° C, 600 Volt applications
- UL Recognized for grounding and bonding to ensure reliability
- Electro-tin plating provides low contact resistance
- Lay-in feature eases installation

Catalog Number	Conductor Range	C	H	J	K	L	N	T	Hex Size
BGBL4	14 - 4	0.38 [10]	0.78 [20]	1/4 - 28	0.22 [6]	1.07 [27]	0.19 [5]	0.15 [4]	Slot
BGBL4SS*	14 - 4	0.38 [10]	0.78 [20]	1/4 - 28	0.22 [6]	1.07 [27]	0.19 [5]	0.15 [4]	Slot
BGBL1/0	14 - 1/0	0.60 [15]	1.17 [30]	3/8 - 24	0.27 [7]	1.50 [38]	0.30 [8]	0.22 [6]	Slot
BGBL250	6 - 250 kcmil	0.80 [20]	1.79 [45]	9/16 - 18	0.33 [8]	2.20 [56]	0.40 [10]	0.30 [8]	5/16

* Suitable for copper conductors only.

TYPE K-SB



Mechanical Shear Bolt Connectors

Copper and Aluminum

The K-SB Shear Bolt connector family allows for terminating or splicing of aluminum or copper conductor without the need of a torque wrench or compression tools and dies. The connectors are designed with shear bolts to break off at the correct torque using a 3/8" hex key. Range taking options available in most sizes to keep the number of SKUs low. From 2/0 AWG up to 1250 kcmil we have you covered with one and two hole terminals as well as splices.

Features & Benefits

- Dual Rated AL9CU for both copper and aluminum conductor
- cULus Listed Wire Connector to UL486A-486B
- Up to 35kV voltage rating
- Easy installation with shear bolt technology, no crimp tools necessary
- 3/8" Hex Key for all sizes
- Tin Plated aluminum connectors and screws
- Range-taking on most sizes



Fig. 1 (One-Hole Lug)

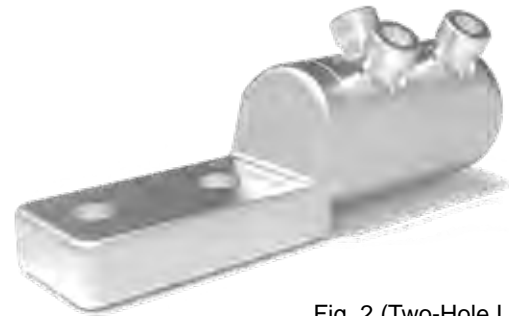

Fig. 2 (Two-Hole Lug)

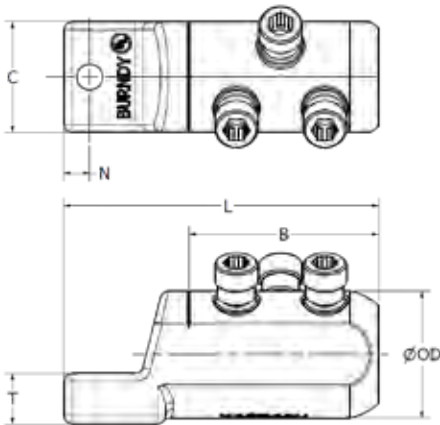

Fig. 1 (One-Hole Lug)

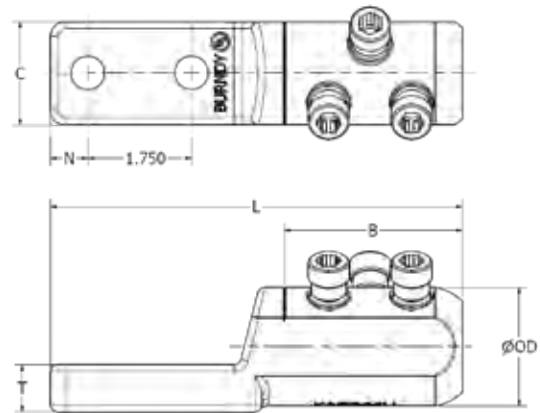

Fig. 2 (Two-Hole Lug)



Fig. 3 (Splice)

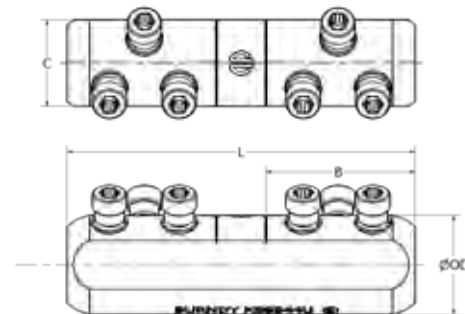

Fig. 3 (Splice)

Catalog Number	Conductor Range Concentric/Compact	Stud Hole	Dimensions							# Shear Bolts	Socket Head Size
			Stud Size	Stud Spacing	Tongue Width	OD	B	L	N		
One-Hole Lug											
KASB28U12	2/0 - 4/0 AWG	1	1/2"	—	1.10	1.25	1.95	4.10	0.63	2	3/8"
KASB31U12	250 - 350 kcmil	1	1/2"	—	1.22	1.50	1.95	4.15	0.63	2	3/8"
KASB34U12	350 - 500 kcmil	1	1/2"	—	1.46	1.75	3.00	5.19	0.63	2	3/8"
KASB39U12	600 - 750 kcmil	1	1/2"	—	1.67	1.90	3.00	5.19	0.63	3	3/8"
KASB44U12	1000 kcmil	1	1/2"	—	1.75	2.01	3.00	5.19	0.63	3	3/8"
KASB45U12	1250 kcmil	1	1/2"	—	2.00	2.26	3.00	5.20	0.63	3	3/8"
Two-Hole Lug											
KASB28U2N	2/0 - 4/0 AWG	2	1/2"	1.75	1.10	1.25	1.95	5.85	0.63	2	3/8"
KASB31U2N	250 - 350 kcmil	2	1/2"	1.75	1.22	1.50	1.95	5.90	0.63	2	3/8"
KASB34U2N	350 - 500 kcmil	2	1/2"	1.75	1.46	1.75	3.00	6.95	0.63	2	3/8"
KASB39U2N	600 - 750 kcmil	2	1/2"	1.75	1.67	1.90	3.00	6.95	0.63	3	3/8"
KASB44U2N	1000 kcmil	2	1/2"	1.75	1.75	2.01	3.00	6.95	0.63	3	3/8"
KASB45U2N	1250 kcmil	2	1/2"	1.75	2.00	2.26	3.00	6.95	0.63	3	3/8"
Splice											
KSSB28U	2/0 - 4/0 AWG	—	—	—	—	1.25	1.95	4.50	—	4	3/8"
KSSB31U	250 - 350 kcmil	—	—	—	—	1.50	1.95	5.00	—	4	3/8"
KSSB34U	350 - 500 kcmil	—	—	—	—	1.75	3.00	7.00	—	4	3/8"
KSSB39U	600 - 750 kcmil	—	—	—	—	1.90	3.00	7.00	—	6	3/8"
KSSB44U	1000 kcmil	—	—	—	—	2.01	3.00	7.00	—	6	3/8"
KSSB45U	1250 kcmil	—	—	—	—	2.26	3.00	7.25	—	6	3/8"

Additional Stud Hole sizes available, please contact Customer Service.

TYPES KA-U, KKA-U

UNIVERSAL TERMINAL

Aluminum and Copper Conductors



AL9CU

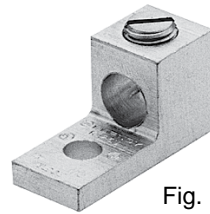

Fig. 1



Fig. 2

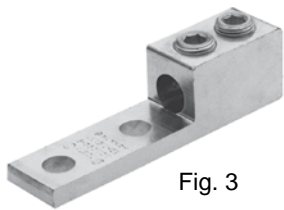

Fig. 3

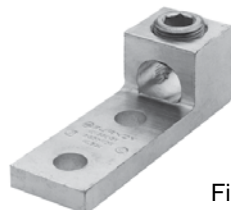

Fig. 4

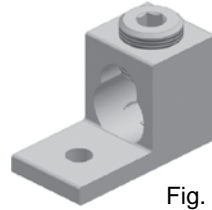
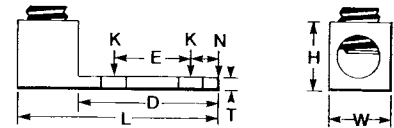

Fig. 5



Catalog Number*	Fig. No.	Wire Range Aluminum or Copper	Stud Hole Size	D	L	N	** W	E	T	** H	Recommended Tightening ▲ Torque (in-lb)
KA6U	1	14 AWG-6 AWG	1/4	0.63	1.06	0.25	0.50	—	0.09	0.51	45
KA2U	1	14-2	1/4	0.63	1.16	0.31	0.50	—	0.10	0.56	50
KA25U	1	14 AWG-1/0	1/4	0.81	1.50	0.44	0.63	—	0.19	0.92	50
KA26U	2	14 AWG-2/0	1/4	0.81	1.47	0.45	0.63	—	0.19	0.80	120
KA29U	2	6-250	5/16	0.94	2.00	0.47	1.00	—	0.25	1.14	275
KA30U	2	6 AWG-300 kcmil	5/16	0.94	2.00	0.45	1.00	—	0.25	1.14	275
KA31U	2	6 AWG-350 kcmil	3/8	1.03	2.25	0.52	1.13	—	0.25	1.27	275
KA34U	2	4 AWG-500 kcmil	3/8	1.50	2.81	0.88	1.51	—	0.31	1.58	500
KA36U	2	2 AWG-600 kcmil	3/8	1.72	3.19	0.78	1.50	—	0.44	1.58	500
KA40U	2	300 kcmil-800 kcmil	1/2	1.85	3.50	0.81	1.75	—	0.50	1.95	550
KA44U	2	500 kcmil-1000 kcmil	1/2	1.69	3.50	0.88	1.75	—	0.50	1.95	550
KKA31U2N	3	6 AWG-350 kcmil	1/2	3.16	5.50	0.63	1.25	1.75	0.38	1.52	275
KA36U2N	4	2 AWG-600 kcmil	1/2	3.22	4.69	0.63	1.50	1.75	0.44	1.57	500
KA40U2N	4	300 kcmil-800 kcmil	1/2	3.03	4.75	0.63	1.75	1.75	0.50	1.95	500
KA44U2N	4	500 kcmil-1000 kcmil	1/2	3.03	4.75	0.63	1.75	1.75	0.50	1.95	550
KA30226U	5†	6 Str. - 300 kcmil or (2) 4 Str. - 2/0 Str.	5/16	1.31	2.31	2.00	0.86	0.69	0.25	1.50	275
KA36229U	5	4 Str. - 600 kcmil or (2) 250 kcmil - 1/0 Str.	3/8	1.50	2.81	1.00	1.38	—	0.31	1.81	550
KA39230U	5	#2 Str. - 750 kcmil or (2) 1/0 Str. - 300 kcmil	3/8	1.50	2.81	1.00	1.38	—	0.31	1.81	550

* "N" indicates NEMA standard stud holes.

▲ Listed torque values are for maximum conductor sizes accommodated.

Consult UL486 Tables 7-4, 7-5, 7-6 for smaller conductor sizes.

† Figure 5 keyhole style with 2 hole pad.

** Maximum dimension.

TYPE K2A-U

UNIVERSAL TERMINAL

Aluminum and Copper Conductors
(Two Conductors)

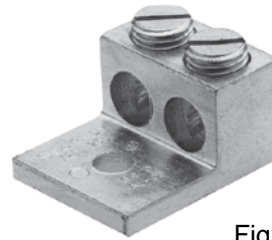

Fig. 1

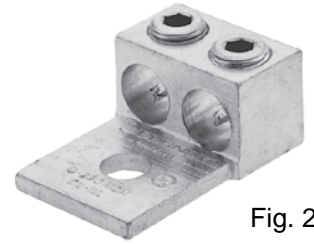

Fig. 2

These dual-rated two-conductor lugs are constructed from high strength aluminum alloy and electro tin-plated to provide low contact resistance.

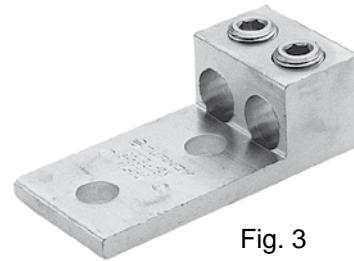
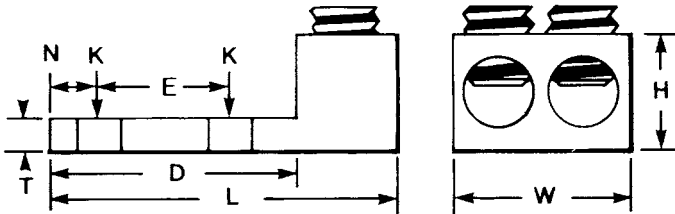

Fig. 3

Catalog Number*	Fig. No.	TWO: Wire Range (Aluminum or Copper)	Stud Hole Size	D	L	N	** W	E	T	** H	Recommended Tightening ▲ Torque (in-lb)
K2A25U	1	14 AWG-1/0	1/4	0.81	1.47	0.44	1.13	—	0.19	0.79	50
K2A26U	2	14 AWG-2/0 AWG	1/4	0.81	1.47	0.44	1.25	—	0.19	0.80	120
K2A29U	2	6 AWG-250 kcmil	3/8	1.50	2.56	0.50	1.66	—	0.25	1.20	275
K2A31U	2	6 AWG-350 kcmil	1/2	1.69	2.88	0.88	1.94	—	0.25	1.26	275
K2A36U	2	2 AWG-600 kcmil	1/2	1.75	3.20	0.63	2.41	—	0.44	1.58	375
K2A40U	2	300 kcmil-800 kcmil	5/8	1.66	3.38	0.88	3.19	—	0.50	1.95	500
K2A44U	2	500 kcmil-1000 kcmil	5/8	1.66	3.50	0.88	3.52	—	0.50	1.95	500
K2A31U2N	3	6 AWG-350 kcmil	1/2	3.00	4.50	0.63	2.31	1.75	0.31	1.39	275
K2A36U2N	3	2 AWG-600 kcmil	1/2	3.22	4.69	0.63	2.41	1.75	0.44	1.39	375
K2A40U2N	3	300 kcmil-800 kcmil	1/2	3.03	4.75	0.63	3.19	1.75	0.50	1.95	375
K2A44U2N	3	500 kcmil-1000 kcmil	1/2	3.03	4.75	0.63	3.19	1.75	0.50	1.95	375

* "N" indicates NEMA standard stud holes.

▲ Listed torque values are for maximum conductor combinations accommodated.

Consult UL486 Tables 21, 22, 23 (found in Section O of this catalog) for smaller conductor combinations.

** Maximum dimension.

TYPES K3A-U, KK3A-U

UNIVERSAL TERMINAL

Aluminum and Copper Conductors
(Three Conductor)

Dual-rated three-conductor lugs are constructed from high strength aluminum alloy and electro tin-plated to provide low contact resistance.



AL9CU



Fig. 1



Fig. 2



Fig. 3



Fig. 4

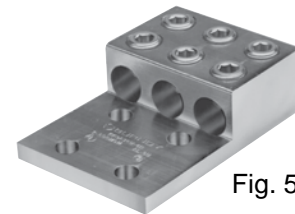
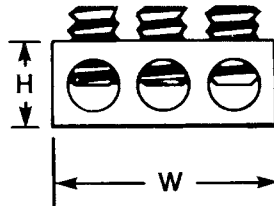
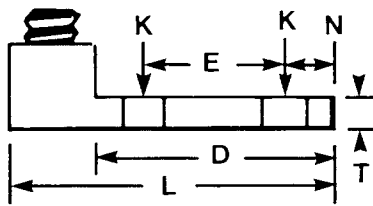

Fig. 5

Catalog Number**	Fig. No.	THREE: Wire Range (Aluminum or Copper)	K	Stud Hole Size	Dimensions							Rec. Tightening ▲ Torque (in-lb)
					D	L	N	W	E	T	H	
K3A2U2*	1	14 AWG-2 AWG	11/32	5/16	1.63	2.19	0.34	1.59	0.88	0.19	0.62	50
K3A25U2*	1	14 AWG-1/0	7/16	3/8	2.09	2.91	0.34	1.94	1.00	0.25	0.88	50
K3A26U2N	3	14 AWG-2/0 AWG	9/16	1/2	3.06	3.75	0.63	1.95	1.75	0.19	1.79	50
K3A27U2N	3	6 AWG-3/0 AWG	9/16	1/2	3.00	3.88	0.63	2.81	1.75	0.31	1.12	275
K3A29U2N	3	6 AWG-250 kcmil	9/16	1/2	3.16	4.00	0.63	2.81	1.75	0.31	1.19	275
K3A31U2N	3	6 AWG-350 kcmil	9/16	1/2	3.16	4.31	0.63	3.52	1.75	0.31	1.38	275
K3A36U2N	3	2 AWG-600 kcmil	9/16	1/2	3.22	4.69	0.63	3.63	1.75	0.44	1.56	375
KK3A36U2N	2	2 AWG-600 kcmil	9/16	1/2	3.00	5.50	0.63	4.22	1.75	0.38	1.52	375
KK3A40U2N	2	300 kcmil-800 kcmil	9/16	1/2	3.34	6.19	0.63	4.81	1.75	0.56	1.89	375
KK3A44U2N	2	500 kcmil-1000 kcmil	9/16	1/2	3.34	6.19	0.63	4.75	1.75	0.56	1.90	500
K3A2U4*	4	14 AWG-2 AWG	11/32	5/16	1.63	2.19	0.34	1.59	0.88	0.19	0.62	50
K3A25U4*	4	14 AWG-1/0	7/16	3/8	2.09	2.91	0.34	1.94	1.00	0.25	0.88	50
K3A27U4N	4	6 AWG-3/0 AWG	9/16	1/2	3.00	3.88	0.63	2.81	1.75	0.31	1.12	275
K3A29U4N	4	6 AWG-250 kcmil	9/16	1/2	3.00	4.00	0.63	2.81	1.75	0.31	1.19	275
K3A31U4N	4	6 AWG-350 kcmil	9/16	1/2	3.00	4.31	0.63	3.00	1.75	0.31	1.38	275
K3A36U4N	4	2 AWG-600 kcmil	9/16	1/2	3.22	4.69	0.63	3.63	1.75	0.44	1.56	375
K3A40U4N	4	300 kcmil-800 kcmil	9/16	1/2	3.03	4.75	0.63	4.81	1.75	0.50	1.94	375
KK3A36U4N	5	2 AWG-600 kcmil	9/16	1/2	3.00	5.50	0.63	4.22	1.75	0.38	1.52	375
KK3A40U4N	5	300 kcmil-800 kcmil	9/16	1/2	3.34	6.19	0.63	5.34	1.75	0.56	1.89	500
KK3A44U4N	5	500 kcmil-1000 kcmil	9/16	1/2	3.34	6.19	0.63	4.75	1.75	0.56	1.90	500

* Slotted screw.

** 'N' indicates NEMA standard stud holes.

▲ Listed torque values are for maximum conductor combinations accommodated.

Consult UL486 Tables 21, 22, 23 (found in Section O of this catalog) for smaller conductor combinations.

✓ All 4N items see note LIGHTNING PROTECTION INFO.

TYPES K4A-U, KK4A-U

UNIVERSAL TERMINAL

Aluminum and Copper Conductors
(Four Conductors)

These dual-rated four conductor lugs are constructed from high strength aluminum alloy and electro tin-plated to provide low contact resistance.

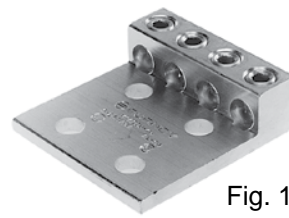

Fig. 1

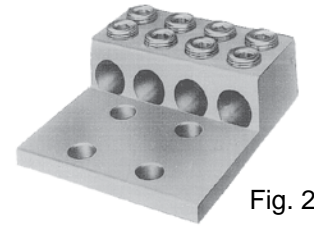
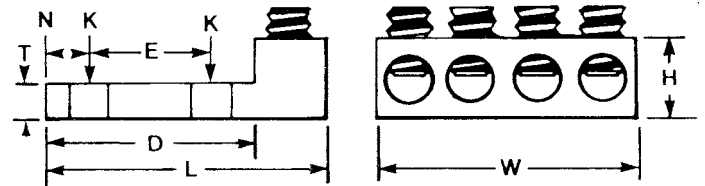

Fig. 2



Catalog Number*	Fig. No.	FOUR: Wire Range (Aluminum or Copper)	Stud Hole Size	Dimensions							Recommended Tightening Torque (in-lb)
				D	L	N	W	E	T	H	
K4A29U4N	1	6 AWG-250 kcmil	1/2	3.16	4.25	0.63	3.69	1.75	0.31	1.19	275
K4A31U4N	1	6 AWG-350 kcmil	1/2	3.00	4.50	0.63	5.04	1.75	0.31	1.38	275
KK4A36U4N	2	2 AWG-600 kcmil	1/2	3.34	5.63	0.63	5.00	1.75	0.44	1.51	375
KK4A40U4N	2	300 kcmil-800 kcmil	1/2	3.41	6.19	0.63	6.00	1.75	0.56	1.88	375

* "N" indicates NEMA standard stud holes.

⚡ All 4N items see note LIGHTNING PROTECTION INFO.

TYPES K11A-U, K21A-U, K22A-U

UNIVERSAL TERMINAL

Aluminum and Copper Conductors

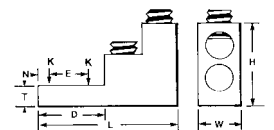
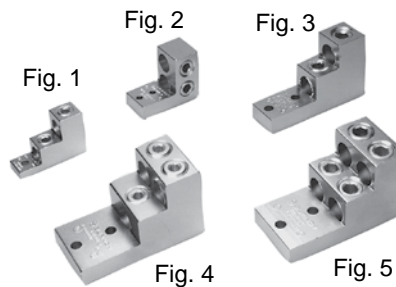

Dual-rated panelboard lugs are constructed from high strength extruded aluminum alloy and electro tin-plated to provide low contact resistance.

Catalog Number	Fig. No.	# of Conductors	Wire Range (Aluminum or Copper)	Stud Hole Size	D	L	N	W	E	T	H	Recommended Tightening ▲ Torque (in-lb)
K11A30U	1	2	6 AWG-300 kcmil	5/16	0.94	3.00	0.47	1.00	—	0.50	2.03	275
K11A34U2	2	2	4/0 AWG-500 kcmil	1/4	2.31	2.91	0.25	1.44	0.69	0.63	2.40	375
K11A36U2	3	2	2 AWG-600 kcmil	3/8	2.31	4.91	0.38	1.50	1.38	0.75	3.02	375
K21A36U2	4	3	2 AWG-600 kcmil	3/8	2.31	4.91	0.38	2.50	1.38	0.75	3.03	375
K22A36U2	5	4	2 AWG-600 kcmil	3/8	2.31	4.91	0.38	2.50	1.38	0.75	3.03	375
K11A39U2	3	2	1/0 -750 kcmil	3/8	2.31	4.91	0.38	1.69	1.38	0.75	3.02	375
K22A39U2	5	4	1/0 -750 kcmil	3/8	2.31	4.91	0.38	3.06	1.38	0.75	3.02	375

▲ Listed torque values are for maximum conductor combinations accommodated. Consult UL486 Tables 21, 22, 23 (found in Section O of this catalog) for smaller conductor combinations.

TYPE K-A-U2N

UNIVERSAL TERMINAL



Aluminum and Copper Conductors
(One to Four Conductors; NEMA-Spaced Tongue)

These panel board terminals allow multiple conductors to be terminated to equipment pads, bus bars, or other electrical equipment. Conductor ports are in a stacked arrangement to save space. They are made from high strength aluminum alloy and are tin-plated for low contact resistance.

Features & Benefits

- Dual rated AL9CU for both copper and aluminum conductor
- 600 Volt Rated
- UL Listed UL486A-486B; CSA Certified C22.2 No. 65
- Range taking conductor ports
- Each size can accommodate up to 4 conductors
- 1/2" diameter stud holes spaced 1-3/4" apart (NEMA-spacing)



Fig. 1



Fig. 2



Fig. 3

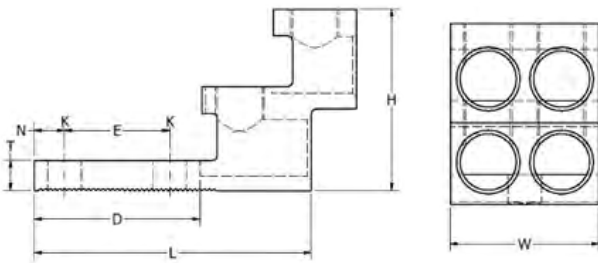

Catalog Number	Fig. #	# of Conductors	Wire Range	W	Stud Hole Size	D	L	N	E	T	H	Rec. Installation Torque (in-lbs)
K11A36U2N	1	2	#2 AWG - 600 kcmil	1.50"	1/2"	2.75"	5.34"	0.50"	1.75"	0.50"	3.00"	375
K21A36U2N	2	3		2.47"								
K22A36U2N	3	4		2.47"								
K11A39U2N	1	2	1/0 AWG - 750 kcmil	1.50"	1/2"	2.75"	5.34"	0.50"	1.75"	0.50"	3.00"	375
K21A39U2N	2	3		2.75"								
K22A39U2N	3	4		2.75"								

TYPES K6A-U, K8A-U, KK6A-U, KK8A-U

UNIVERSAL TERMINALS

Aluminum and Copper Conductors
(Six and Eight Conductors)

These dual-rated six and eight conductor lugs are constructed from high strength aluminum alloy and electro tin-plated to provide low contact resistance.

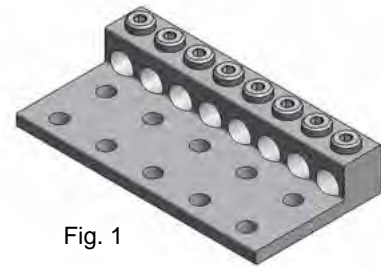

Fig. 1

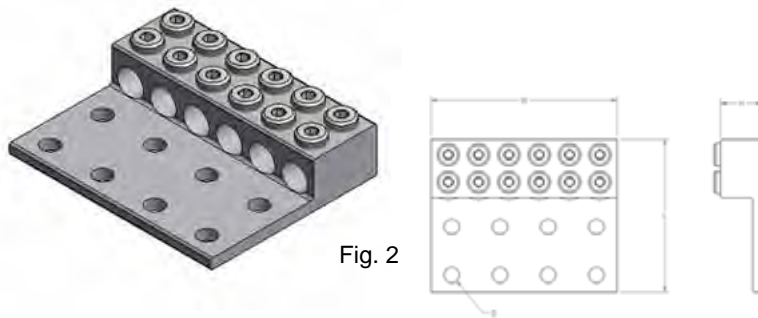

Fig. 2

Catalog Number	Fig. No.	No. of Conductors	No. of Mtg Holes	Wire Range Aluminum or Copper	Stud Hole Size	Depth	Width	Height	Rec. Tightening Torque in-lb ▲
K6A34U8	1	6	8	10 AWG - 500 kcmil	9/16	4.63	6.75	1.56	375
K8A34U10	1	8	10	10 AWG - 500 kcmil	9/16	4.63	8.75	1.56	375
KK6A31U8	2	6	8	12 AWG - 350 kcmil	9/16	5.31	6.38	1.50	275
KK8A31U10	2	8	10	12 AWG - 350 kcmil	9/16	5.31	8.13	1.50	275
KK6A34U8	2	6	8	10 AWG - 500 kcmil	9/16	5.50	6.75	1.50	375
KK8A34U10	2	8	10	10 AWG - 500 kcmil	9/16	5.50	8.75	1.50	375
KK8A39U12	2	8	12	2 AWG - 750 kcmil	9/16	6.19	10.25	1.88	550
KK6A44U12	2	6	12	350 kcmil - 1000 kcmil	9/16	6.19	10.00	1.88	550
KK8A44U14	2	8	14	350 kcmil - 1000 kcmil	9/16	6.19	12.12	1.88	550

▲ Listed torque values are for maximum conductor combinations accommodated. Consult UL486 Tables 21, 22, 23 (found in Section O of this catalog) for smaller conductor combinations.

TYPES KK-A-U-S, KK-A-U-L

UNIVERSAL TERMINAL

Aluminum and Copper Conductors

Stacked Style - Type KK-A-U-S (figure 1)

Lay-In Style - Type KK-A-U-L (figure 2)

The Stacked Style configuration accommodate #2 AWG - 750 kcmil conductor. The stacked style is ideal for limited space applications. Up to 12 conductors can be accommodated, each port is range taking and the terminals accept aluminum and/or copper conductor. Mounting holes are NEMA-spaced with a 1/2" bolt hole.

The Lay-In Style configuration accommodate 1/0 AWG - 1000 kcmil conductor. The lay-in style makes cable insertion a breeze. Each size can accommodate up to 8 conductors. Mounting holes are NEMA-spaced with a 1/2" bolt hole.

Features & Benefits

- Fabricated from 6061-T6 aluminum alloy for conductivity and strength
- Clear plated for low-contact resistance
- For use with both copper and aluminum conductor
- Stacked configurations are ideal in limited space applications
- Lay-In configurations offer ease of conductor insertion



Fig. 1

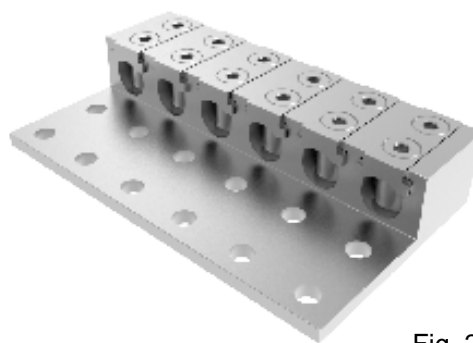

Fig. 2

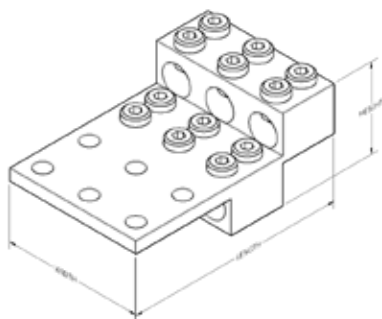

Fig 1 Line Art

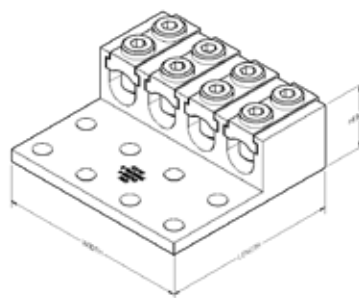

Fig 2 Line Art

Catalog Number	Fig. #	# of Conductors	# of Mounting Holes	Wire Range (Aluminum or Copper)	Stud Hole Size	Hole Spacing	Length	Width	Height	Rec. Installation Torque (in-lbs)
Stacked Style										
KK6A39U6SNP	1	6	6	#2 AWG - 750 kcmil	1/2"	1.75"	7.50	4.75	3.00	#2 - 750 @ 180-240
KK8A39U8SNP		8	8				7.50	6.50	3.00	
KK12A39U10SNP		12	10				7.50	8.25	3.00	
Lay-In Style										
KK4A39U8LNP	2	4	8	#2 AWG - 750 kcmil	1/2"	1.75"	6.00	6.50	2.20	4/0 - 350 @ 275-450
KK6A39U12LNP		6	12				6.00	10.25	2.20	
KK8A39U16LNP		8	16				6.00	13.50	2.20	
KK4A44U8LNP	2	4	8	1/0 AWG - 1000 kcmil	1/2"	1.75"	6.00	6.75	2.20	400 - 1000 @ 475-550
KK6A44U12LNP		6	12				6.00	10.25	2.20	
KK8A44U16LNP		8	16				6.00	13.50	2.20	

Remove -NP Suffix for connector pre-filled with PENETROX™ oxide inhibitor

TYPE KAU-KIT

TRANSFORMER LUG KIT

These dual-rated lugs are constructed from high strength aluminum alloy and electro tin-plated to provide low contact resistance. Lugs and mounting hardware packaged together in these kits.

Features & Benefits

- UL Listed and CSA Certified, AL9CU dual rated set screw terminals to ensure the transformer feeders and taps are terminated properly
- Plated steel cap screws and hex nuts with captive conical washers or individual Belleville washers
- Terminal to bus connections are made using proper hardware resulting in true torque to pressure performance - compensates for dissimilar metal expansion and contraction
- Hardware packed in plastic bag to prevent lost hardware prior to installation
- Larger 800 kcmil lugs in KIT3 and KIT4 accommodates common 750 kcmil tap conductors in larger transformers

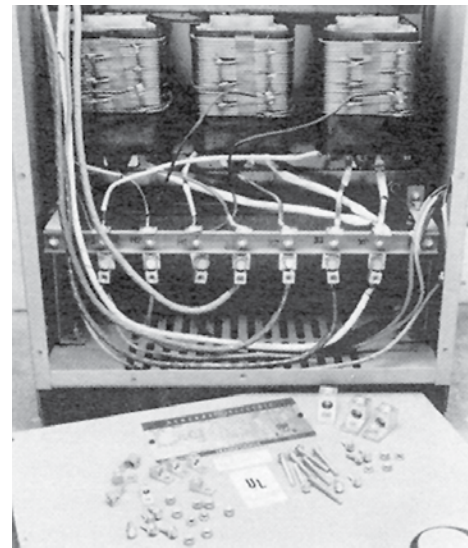
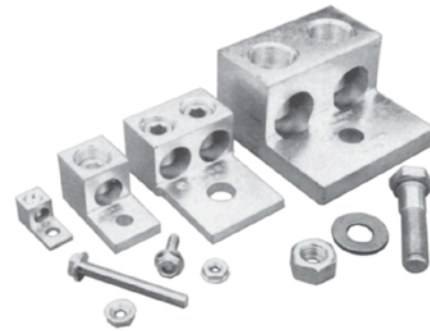

Catalog Number	Transformer KVA Rating	Terminals		Wire Range Aluminum or Copper	Hardware					
		Qty	Catalog Number		Qty	Bolt Size	Qty	Nut	Qty	Washer
KAUKIT1	15 - 37.5 1Ø	8	KA2U	14 AWG-250 kcmil	8	1/4-20 X 3/4 HH	8	1/4 X 20 HN	-	Captive to Nut
	15 - 45 3Ø	4	KA29U							
KAUKIT2	50 - 75 1Ø	12	KA29U	6 AWG-250 kcmil	8	1/4-20 X 3/4 HH	16	1/4 X 20 HN	-	Captive to Nut
	75 - 112.5 3Ø				8	1/4-20 X 2 HH				
KAUKIT3	100 - 167 1Ø	6	K2A31U	6 AWG-800 kcmil	5	1/2-13 X 3 HH	11	1/2-13 HN	22	1/2 FW
	150 - 300 3Ø	7	K2A40U		6	1/2-13 X 2-1/2 HH				
KAUKIT4	400 - 500 3Ø	15	K2A40U	300 kcmil-800 kcmil	7	1/2-13 X 2 HH	11	1/2-13 HN	22	1/2 FW
					4	1/2-13 X 2-1/2 HH				

HH = Hex Head
 HN = Hex Nut
 FW = Flat Washer

TYPES KAP / KAPO

MECHANICAL PIN ADAPTORS



AL9CU



Aluminum and Copper Conductors

Five range taking sizes accommodate from #6 to 750 kcmil. Each size is offered in a center and off-centered pin design. The off-centered pins can be rotated to prevent interference when installing conductors side-by-side in limited space applications. Insulated covers are provided with each connector to prevent contact between it and uninsulated live parts of opposite polarity or grounding metal.

UL Listed for use with Flex (fine stranded) conductor; four smaller sizes utilize a disc-pan screw preventing damage to the fine strands as the conductor is compressed during installation.

Features & Benefits

- AL9CU Dual rated for both copper and aluminum conductor; 600 Volt Rated
- UL Listed to UL Wire Connector Standard UL486A-B
- Rated for use with Flex (fine stranded) conductor
- Range taking conductor port
- Off-centered pin available to reduce center-to-center distance between adjacent pins
- Easy installation with the use of a torque wrench - no crimping tool and/or die required
- Plastisol insulated covers provided with each connector
- Covers are molded to fit around set screws protruding from connector

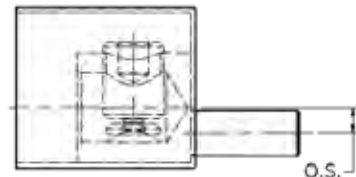
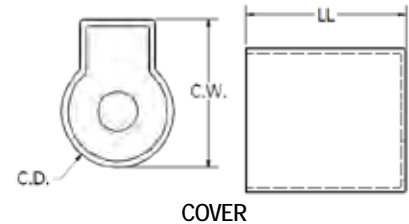
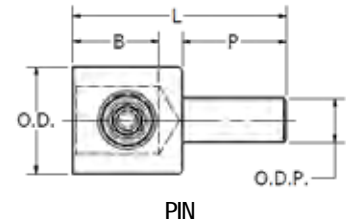

ASSEMBLY

Catalog Number	Wire Range Class B, C, H, I, K, DLO	Pin Dimensions						Cover Dimensions			Assy Dim. O.S.	Installation Torque (in-lbs)		Hex Key	Amp Rating
		O.D.	B (Strip Length)	L	P	O.D.P.	Pin Size Equiv.	C.D.	C.W.	LL		Range	Torque		
KAP1/0	#6 - 1/0 AWG	1.00	.97	2.01	.84	.29	2 AWG	1.12	1.43	1.92	—	#6 - 1/0 AWG	100	1/4"	170
KAPO1/0		[25]	[25]	[51]	[21]	[7]		[28]	[36]	[49]	.27/[7]				
KAP250R	#2 - 250 kcmil	1.25	1.00	2.47	1.09	0.33	1/0 AWG	1.43	1.81	2.22	—	#2 - 2/0 AWG 3/0 AWG - 262 DLO	180 300	5/16"	290
KAPO250R		[32]	[25]	[63]	[28]	[8]		[36]	[46]	[56]	.37/[9]				
KAP350R	1/0 - 350 kcmil	1.38	1.11	2.75	1.34	0.42	3/0 AWG	1.50	2.00	2.22	—	1/0 AWG - 373 DLO	450	3/8"	350
KAPO350R						[13]					.31/[8]				
KAP350						.57	—								
KAPO350						[14]	.31/[8]								
KAP500R	4/0 - 500 kcmil	1.50	1.10	2.92	1.34	0.57	300 kcmil	1.68	2.43	2.42	—	4/0 AWG 250 kcmil - 535 DLO	400 600	1/2"	430
KAPO500R		[38]	[28]	[74]	[34]	[14]		[43]	[62]	[61]	.38/[10]				
KAP750	350 - 750 kcmil	1.75	2.30	4.46	1.76	.81	500 kcmil	1.87	2.37	3.51	—	350 - 750 kcmil	500	1/2"	535
KAPO750		[44]	[58]	[113]	[45]	[21]		[48]	[60]	[89]	.38/[10]				

TYPE AMS

DUAL RATED SPLICER/REDUCER

Copper and Aluminum Cable

All splicer/reducers are dual rated for use with aluminum and copper conductors and are constructed from high strength, tin plated aluminum. PENETROX™ oxide inhibiting joint compounds are recommended for all aluminum applications.



Features & Benefits

- All connectors are tin-plated to provide low contact resistance and prevents galvanic corrosion
- Connectors feature rounded bottoms which facilitates taping
- Solid center barrier prevents contact of dissimilar metals
- Large screw diameters ensure greater surface contact with wires for maximum pullout force
- Large cable range accommodated; each splice is also an effective reducing connector

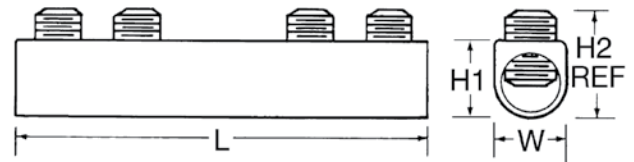

Catalog Number	Wire Range	L	W	H1	H2 Max	Number of Screws	Screw Diameter	Hex Size
	Aluminum & Copper							
AMS2*	14 AWG-2 AWG	1-19/32	9/16	9/16	0.79	2	3/8	Slot
AMS0*	14 AWG-1/0	1-29/32	3/4	3/4	0.86	2	7/16	Slot
AMS4/0	6 AWG-4/0 AWG	2-5/16	1	1-3/32	1.28	2	9/16	5/16
AMS250	6 AWG-250 kcmil	4-3/32	1	1-3/32	1.29	4	5/8	5/16
AMS350	6 AWG-350 kcmil	4-11/32	1	1-3/32	1.3	4	11/16	5/16
AMS500	3/0 AWG-500 kcmil	4-25/32	1-1/4	1-3/8	1.48	4	13/16	3/8
AMS750	250 kcmil-750 kcmil	6-1/6	1-7/16	1-5/8	1.98	4	15/16	1/2
AMS1000	500 kcmil-1000 kcmil	8-11/16	1-21/32	1-7/8	2.34	6	1-1/8	9/16

* Slotted Screws. H2 measured with maximum conductors, reference only.

✓ Complies with NFPA 78-86.

TYPE KPU-TC

POLYTAP™



Insulated Gutter Tap for All Copper and Aluminum Combinations

Wide range-taking tin-plated aluminum parallel and perpendicular clamp and insulating cover for industrial and multiple story structure applications. Covers having flexible fingers that conform to the conductor, fully insulating the connection - eliminating the need for taping. Connector and Cover can be ordered separately. 600 Volt Max. 90° C

Features & Benefits

- 600 Volt Rated
- AL9CU dual rated for use with aluminum or copper conductor
- UL Listed to UL486A-B; CSA Certified to C22.2, No. 65
- Manufactured from high strength 6061-T6 aluminum alloy
- Electro tin plated for low contact resistance and protection against corrosion
- Tap parallel or perpendicular to run conductor
- Connectors are re-useable

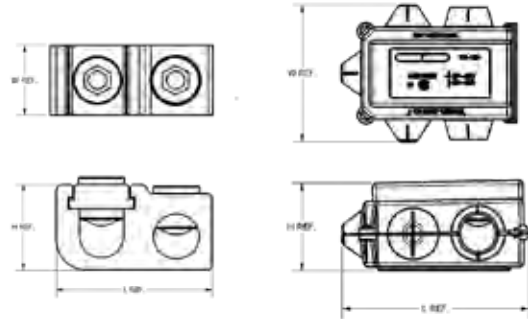

Catalog Number			Wire Range (Copper or Aluminum)		Connector/Cover in [mm]			Cover Color	Rec. Tightening Torque in-lb (AWG)
Connector with Cover	Connector Only	Cover Only	Run	Tap	H	L	W		
KPU2C4CTC	KPU2C4CT	KPU1C	12 AWG - 2 AWG	14 AWG - 4 AWG (Cu) 12 AWG - 4 AWG (Al)	.88 [22] 2.62 [67]	1.39 [35] 1.55 [39]	.63 [16] 1.26 [32]	Yellow	35 (10-14); 40 (8); 45 (4-6); 50 (2-3)
KPU2929TC	KPU2929T	KPU3C	1/0 AWG - 250 kcmil	6 AWG - 250 kcmil	1.31 [33] 3.44 [87]	2.28 [58] 2.00 [51]	1.06 [27] 1.63 [41]	Red	275
KPU3434TC	KPU3434T	KPU5C	350 kcmil - 500 kcmil	2 AWG - 500 kcmil	1.75 [44] 4.89 [124]	3.13 [79] 2.34 [59]	1.38 [35] 2.12 [54]	Blue	375

TYPE UCU-AC

RISER TAP



600 VOLT MAX. 90° C MAX

Parallel-groove riser tap and insulation cover for copper and aluminum. Wide range-taking assembly for apartment house and light industrial applications. Cover and connector are packaged together. Covers having insulating fingers that conform to conductors, fully insulating the connection. UL486B Listed for 600 volts max. 90° C service

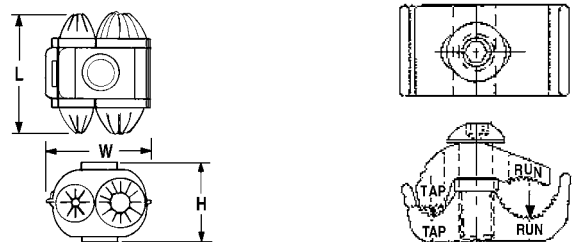
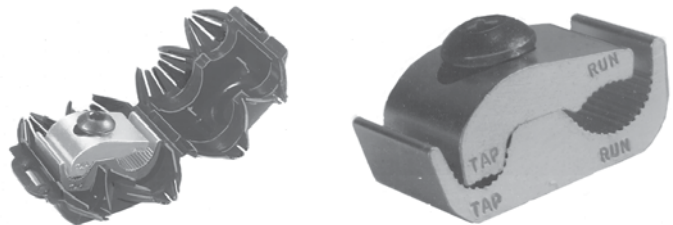

Catalog Number	Conductor Copper or Aluminum		W	H	L	Recommended Tightening ▲ Torque in-lb
	Run	Tap				
UCU28AC	#2 Str.- 4/0 Str.	#10 Sol. - #2 Str.	2-1/4	1-13/16	2-5/8	120

▲ Listed torque values are for maximum conductor combinations accommodated. Consult UL486 Tables 21, 22, 23 (found in Section O of this catalog) for smaller conductor combinations.

TYPE AGSKIT

ABOVE GRADE SPLICE KITS

Aluminum or Copper/Aluminum Combinations

Type AGS Above Grade Splice Kit consists of a standard AMS splice/reducer and a heavy wall heat-shrink sleeve. The AMS Splice is dual rated for use with aluminum and copper conductors and are constructed from high strength, tin plated aluminum that provides low contact resistance and reduces the effects of galvanic corrosion. Connector is installed with common installation tools. The heavy wall heat shrink sleeve is lined with adhesive material, providing a positive seal against moisture egress. Heat shrink sleeve is installed with standard propane torch, or electric heat gun.

Catalog Number	Figure Number	Wire Range
AGSKIT2	1	8 AWG-2 AWG
AGSKIT250	2	1 AWG-250 kcmil



TYPE UGSKIT

WATERTIGHT/UNDERGROUND SPLICE KITS

Aluminum or Copper/Aluminum Combinations

Type UGS Watertight Underground Splice Kit consists of a standard AMS splice/reducer and two heavy wall heat-shrink sleeves. The AMS Splice is dual rated for use with aluminum and copper conductors and are constructed from high strength, tin plated aluminum that provides low contact resistance and reduces the effects of galvanic corrosion. Connector installed with common installation tools. Both heavy wall heat shrink sleeves are lined with adhesive material, providing a watertight splice that can withstand abrasions that may occur during direct burial applications. Heat shrink sleeve installed with standard propane torch, or electric heat gun.

Catalog Number	Figure Number	Wire Range
UGSKIT2*	1	8 AWG-2 AWG
UGSKIT250*	2	1 AWG-250 kcmil

*UL486D Listed for Direct Burial



TYPE UGSKIT8

UF DIRECT BURIAL SPLICE KIT



Type UGS UF Splice Kit consists of a UF splice connector and a heavy wall heat-shrink sleeve. The UF splice connector can accommodate up to four UF conductors and is installed with common installation tools. The heavy wall heat shrink sleeve is lined with an adhesive material, providing a water-tight splice that can withstand abrasions that may occur during direct burial applications. Heat shrink sleeve installed with standard propane torch, or electric heat gun.



Catalog Number	Wire Range
	Copper
UGSKIT8*	14 AWG-8 AWG

*UL486D Listed for Direct Burial

TYPE UGS350ULDB

IN-LINE SPLICE/REDUCER

For Direct Burial

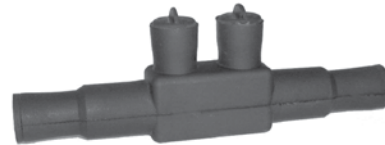

Features & Benefits

- EPDM rubber covered 6061-T6 aluminum connector
- Dual rated AL9CU for copper or aluminum conductor
- UL Listed and CSA Certified for Direct Burial
- Broad range taking capability
- Low installation cost
- Submersible rated
- For use in wet or damp locations excluding Freezing Conditions; ensure products are installed below frost line (where applicable) when used in wet conditions

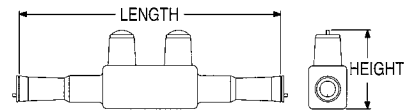

Catalog Number	Wire Range	Length	Height	Hex Size	Torque (In. Lbs.)
UGS350ULDB	12 AWG-350 kcmil	8.50	2.81	5/16	350

BURNDY UNITAP™

THE MOLE™

For Direct Burial
600V, 90° C

Designed specifically for direct burial applications, the MOLE™ in-line splice/reducer is made with a specialized plastisol material that forms a rugged weathertight connection.



Features & Benefits

- UL486D UL Listed for Direct Burial
- AL9CU Dual-rated for copper and aluminum applications; 600 Volts, 90°C
- Plastisol covered AL 6061-T6 aluminum body saves time by eliminating the need for heat shrink
- Oxide inhibitor pre-installed prevents moisture and contaminants from entering the contact area
- Range-taking capability reduces the number of connectors in inventory



Catalog Number	Number of Ports	Wire Range (AWG/kcmil)	L	W	H	Hex Key	Torque (In.-lbs.)	Wire Strip Length
BISR4DB	2	#6 AWG-#4 AWG	4.30	0.68	1.39	1/8	50	7/8"
BISR1DB	2	#2 AWG-#1 AWG	6.30	0.88	1.75	5/32	130	1-3/32"
BISR3/0DB	2	1/0 AWG -3/0 AWG	6.25	0.99	1.96	3/16	120	1-3/32"
BISR250DB	2	4/0 AWG-250 kcmil	6.70	1.18	2.17	5/16	360	1-5/16"

BISR-DB = BURNDY Inline Splice/Reducer Direct Burial.
UNITAP™ rated for code conductor only.

Direct Burial UNITAP™ Connectors

UNITAP™

Dual Rated Multiple Tap Connector

These rubber insulated, dual rated connectors are for use in networks up to 600V. Suitable in light fixture pole bases in commercial, industrial, or residential markets. Distribution within strip malls, for use in any multi-tenant facility. No taping or heat shrink required.



Features & Benefits

- Dual rated for aluminum or copper conductors
- Each unit is individually marked for ease of identification
- Supplied with aluminum set-screws
- Covering is the highest quality EPDM rubber
- Supplied with oxide inhibitor pre-installed
- Submersible rated and suitable for Direct Burial
- Meets ANSI C119.1 and C119.4 requirements
- Rated 600V and 90°C; UL Listed and CSA Certified
- For use in wet or damp locations excluding Freezing Conditions; ensure products are installed below frost line (where applicable) when used in wet conditions
- Silicone provided for conductor insertion

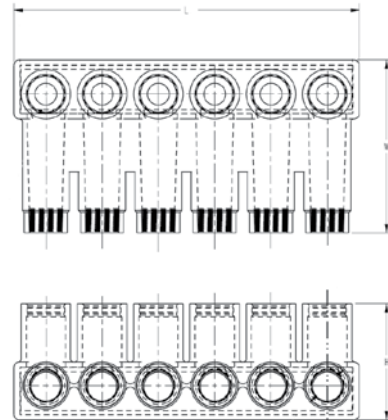

Catalog Number	# of Ports	Wire Range (AWG/kcmil)	L	W	H	Wire Strip Length (in)
BIBS3502DB	2	12 AWG-350 kcmil	2.61	4.06	2.46	1.125
BIBS3503DB	3	12 AWG-350 kcmil	3.82	4.06	2.46	1.125
BIBS3504DB	4	12 AWG-350 kcmil	5.03	4.06	2.46	1.125
BIBS3505DB	5	12 AWG-350 kcmil	6.24	4.06	2.46	1.125
BIBS3506DB	6	12 AWG-350 kcmil	7.45	4.06	2.46	1.125
BIBS5003DB	3	10 AWG-500 kcmil	4.31	4.58	3.13	1.50
BIBS5004DB	4	10 AWG-500 kcmil	5.69	4.58	3.13	1.50
BIBS5005DB	5	10 AWG-500 kcmil	7.06	4.58	3.13	1.50
BIBS5006DB	6	10 AWG-500 kcmil	8.44	4.58	3.13	1.50

Recommended Torque Values for Direct Burial UNITAP™		Recommended BURNDY® Torque Wrench
Conductor Size	Recommended Torque Range	
#12 - #6 AWG	125 - 150 in-lbs	BTW30150
#4 - 3/0 AWG	180 - 240 in-lbs	BTW150750
4/0 - 350 AWG	275 - 450 in-lbs	BTW150750
400 - 1000 AWG	475 - 550 in-lbs	BTW150750



UNITAP™ Clear Insulated Multi-Tap Connectors for Code Conductor

UNITAP™

Clear Insulated Multiple Tap Connectors

Tap connections and in-line splice/reductions are made quickly and easily with the UNITAP™ line of clear insulated connectors for code conductor. UL486B Listed. Dual-rated AL9CU for any stranded copper or stranded aluminum applications. 600 Volt, 90° C. Featuring multiple configurations suitable for most any application.



Features & Benefits

- Clear Plastisol covered AL6061-T6 aluminum body saves time, lowering installation costs and eliminates taping
- Clear Plastisol allows visual confirmation that the conductor is properly inserted
- Oxide inhibitor pre-installed inhibits moisture and contaminants from entering the contact area
- Range-taking capability reduces number of connectors necessary to carry in inventory



In-Line Splice Reducer
Figure 1



Tap - Opposite Side
Entry
Figure 2



Tap - Same Side Entry
Figure 3



Multiple Port Tap
Single Sided Entry
Figure 4



Multiple Port Tap
Double Sided Entry
Figure 5



Multiple Port
Mounted Tap
Single Sided Entry
Figure 6



Multiple Port
Mounted Tap
Double Sided Entry
Figure 7

UNITAP™ Clear Insulated In-Line Splice/Reducer Connectors for Code Conductor

Clear Insulated In-Line Splice/Reducer Connectors



In-Line Splice Reducer
Figure 1

Type BISR in-line splice/reductions are made quickly and easily with the UNITAP™ line of clear insulated connectors for code conductor. UL486B Listed. Dual-rated AL9CU for any stranded copper or stranded aluminum applications. 600 Volt, 90° C. The full UNITAP™ line features multiple configurations suitable for most any application.

Wire Range (AWG/kcmil)	Amp Rating	# of Ports	Configuration	Fig. #	Size (inches)			Hex Key	Catalog Number
					L	W	H		
14 AWG-2 AWG	115 A	2	In-Line Splice Reducer	1	2.38	0.75	1.22	5/32	BISR2
14 AWG-1/0 Str	150 A	2	In-Line Splice Reducer	1	2.91	0.91	1.38	3/16	BISR1/0
10 AWG-250 kcmil	250 A	2	In-Line Splice Reducer	1	4.01	1.19	2.13	5/16	BISR250
10 AWG-350 kcmil	310 A	2	In-Line Splice Reducer	1	4.63	1.34	2.35	5/16	BISR350
6 AWG-500 kcmil	380 A	2	In-Line Splice Reducer	1	5.00	1.62	2.62	3/8	BISR500

Only 1 conductor per port allowed

UNITAP™ Clear Insulated Multi-Tap Connectors for Code Conductor

Clear Insulated In-Line Multi-Tap Connectors



Tap - Opposite Side Entry
Figure 2



Tap - Same Side Entry
Figure 3

Type BIT and BITO (Offset) Multi-Tap connectors are installed quickly and easily and are suitable for use on code conductor. UL486B Listed. Dual-rated AL9CU for any stranded copper or stranded aluminum applications. 600 Volt, 90° C. The full UNITAP™ line features multiple configurations suitable for most any application.

Wire Range (AWG/kcmil)	Amp Rating	# of Ports	Configuration	Fig. #	Size (inches)			Hex Key	Catalog Number
					L	W	H		
14 AWG-4 AWG	85 A	2	Tap - Opposite Side Entry	2	1.16	1.50	1.25	1/8	BITO4
14 AWG-4 AWG	85 A	2	Tap - Same Side Entry	3	1.16	1.16	1.25	1/8	BIT4
14 AWG-2/0 AWG	175 A	2	Tap - Opposite Side Entry	2	1.52	1.56	1.38	3/16	BITO2/0
14 AWG-2/0 AWG	175 A	2	Tap - Same Side Entry	3	1.52	1.40	1.38	3/16	BIT2/0
10 AWG-250 kcmil	255 A	2	Tap - Opposite Side Entry	2	2.03	2.64	2.13	5/16	BITO250
10 AWG-250 kcmil	255 A	2	Tap - Same Side Entry	3	2.03	2.07	2.13	5/16	BIT250
10 AWG-350 kcmil	310 A	2	Tap - Opposite Side Entry	2	2.22	3.00	2.50	5/16	BITO350
10 AWG-350 kcmil	310 A	2	Tap - Same Side Entry	3	2.22	2.32	2.50	5/16	BIT350
4 AWG-600 kcmil	420 A	2	Tap - Opposite Side Entry	2	2.72	3.00	2.75	3/8	BITO600
4 AWG-600 kcmil	420 A	2	Tap - Same Side Entry	3	2.72	2.38	2.75	3/8	BIT600
2 AWG-750 kcmil	475 A	2	Tap - Opposite Side Entry	2	2.87	3.38	3.00	3/8	BITO750 *
2 AWG-750 kcmil	475 A	2	Tap - Same Side Entry	3	2.87	2.70	3.00	3/8	BIT750 *

Only 1 conductor per port allowed

*Not UL Listed

UNITAP™ Clear Insulated Multi-Port Connectors
for Code Conductor; Single-Sided Entry

Clear Insulated Multi-Port Connectors



Type BIBS Multi-Port, Single-Sided Tap connectors for quick, easy tap connections for code conductor. UL486B Listed. Dual-rated AL9CU for any stranded copper or stranded aluminum applications. 600 Volt, 90° C. Featuring multiple configurations suitable for most any application.

Multiple Port Tap Single Sided Entry
Figure 4

Wire Range (AWG/kcmil)	Amp Rating	# of Ports	Configuration	Fig. #	Size (inches)			Hex Key	Catalog Number
					L	W	H		
14 AWG-4 AWG	85 A	3	Multiple Port Tap Single Sided Entry	4	1.51	1.25	1.25	1/8	BIBS43
14 AWG-4 AWG	85 A	4	Multiple Port Tap Single Sided Entry	4	1.95	1.25	1.25	1/8	BIBS44
14 AWG-4 AWG	85 A	5	Multiple Port Tap Single Sided Entry	4	2.39	1.25	1.25	1/8	BIBS45
14 AWG-4 AWG	85 A	6	Multiple Port Tap Single Sided Entry	4	2.83	1.25	1.25	1/8	BIBS46
14 AWG-4 AWG	85 A	8	Multiple Port Tap Single Sided Entry	4	3.71	1.25	1.25	1/8	BIBS48
14 AWG-2/0 Str	175 A	3	Multiple Port Tap Single Sided Entry	4	2.19	1.31	1.38	3/16	BIBS2/03
14 AWG-2/0 Str	175 A	4	Multiple Port Tap Single Sided Entry	4	2.86	1.31	1.38	3/16	BIBS2/04
14 AWG-2/0 Str	175 A	5	Multiple Port Tap Single Sided Entry	4	3.53	1.31	1.38	3/16	BIBS2/05
14 AWG-2/0 Str	175 A	6	Multiple Port Tap Single Sided Entry	4	4.20	1.31	1.38	3/16	BIBS2/06
14 AWG-2/0 Str	175 A	8	Multiple Port Tap Single Sided Entry	4	5.55	1.31	1.38	3/16	BIBS2/08
14 AWG-2/0 Str	175 A	10	Multiple Port Tap Single Sided Entry	4	6.89	1.31	1.38	3/16	BIBS2/010
14 AWG-2/0 Str	175 A	12	Multiple Port Tap Single Sided Entry	4	8.24	1.31	1.38	3/16	BIBS2/012
14 AWG-2/0 Str	175 A	14	Multiple Port Tap Single Sided Entry	4	9.58	1.31	1.38	3/16	BIBS2/014
10 AWG-250 kcmil	255 A	3	Multiple Port Tap Single Sided Entry	4	2.97	2.07	2.13	5/16	BIBS2503
10 AWG-250 kcmil	255 A	4	Multiple Port Tap Single Sided Entry	4	3.91	2.07	2.13	5/16	BIBS2504
10 AWG-250 kcmil	255 A	5	Multiple Port Tap Single Sided Entry	4	4.84	2.07	2.13	5/16	BIBS2505
10 AWG-250 kcmil	255 A	6	Multiple Port Tap Single Sided Entry	4	5.78	2.07	2.13	5/16	BIBS2506
10 AWG-250 kcmil	255 A	8	Multiple Port Tap Single Sided Entry	4	7.66	2.07	2.13	5/16	BIBS2508
10 AWG-250 kcmil	255 A	10	Multiple Port Tap Single Sided Entry	4	9.53	2.07	2.13	5/16	BIBS25010
10 AWG-250 kcmil	255 A	12	Multiple Port Tap Single Sided Entry	4	11.41	2.07	2.13	5/16	BIBS25012
10 AWG-250 kcmil	255 A	14	Multiple Port Tap Single Sided Entry	4	13.29	2.07	2.13	5/16	BIBS25014
10 AWG-350 kcmil	310 A	3	Multiple Port Tap Single Sided Entry	4	3.13	2.32	2.50	5/16	BIBS3503
10 AWG-350 kcmil	310 A	4	Multiple Port Tap Single Sided Entry	4	4.04	2.32	2.50	5/16	BIBS3504
10 AWG-350 kcmil	310 A	5	Multiple Port Tap Single Sided Entry	4	4.95	2.32	2.50	5/16	BIBS3505
10 AWG-350 kcmil	310 A	6	Multiple Port Tap Single Sided Entry	4	5.86	2.32	2.50	5/16	BIBS3506
10 AWG-350 kcmil	310 A	8	Multiple Port Tap Single Sided Entry	4	7.68	2.32	2.50	5/16	BIBS3508
10 AWG-350 kcmil	310 A	10	Multiple Port Tap Single Sided Entry	4	9.5	2.32	2.50	5/16	BIBS35010
10 AWG-350 kcmil	310 A	12	Multiple Port Tap Single Sided Entry	4	11.32	2.32	2.50	5/16	BIBS35012
10 AWG-350 kcmil	310 A	14	Multiple Port Tap Single Sided Entry	4	13.14	2.32	2.50	5/16	BIBS35014

UNITAP™ (Continued)

Wire Range (AWG/kcmil)	Amp Rating	# of Ports	Configuration	Fig. #	Size (inches)			Hex Key	Catalog Number
					L	W	H		
4 AWG-600 kcmil	420 A	3	Multiple Port Tap Single Sided Entry	4	4.00	2.38	2.75	3/8	BIBS6003
4 AWG-600 kcmil	420 A	4	Multiple Port Tap Single Sided Entry	4	5.28	2.38	2.75	3/8	BIBS6004
4 AWG-600 kcmil	420 A	5	Multiple Port Tap Single Sided Entry	4	6.56	2.38	2.75	3/8	BIBS6005
4 AWG-600 kcmil	420 A	6	Multiple Port Tap Single Sided Entry	4	7.84	2.38	2.75	3/8	BIBS6006
4 AWG-600 kcmil	420 A	8	Multiple Port Tap Single Sided Entry	4	10.41	2.38	2.75	3/8	BIBS6008
4 AWG-600 kcmil	420 A	10	Multiple Port Tap Single Sided Entry	4	12.97	2.38	2.75	3/8	BIBS60010
4 AWG-600 kcmil	420 A	12	Multiple Port Tap Single Sided Entry	4	15.53	2.38	2.75	3/8	BIBS60012
4 AWG-600 kcmil	420 A	14	Multiple Port Tap Single Sided Entry	4	18.09	2.38	2.75	3/8	BIBS60014
2 AWG-750 kcmil	475 A	3	Multiple Port Tap Single Sided Entry	4	4.00	2.70	3.00	3/8	BIBS7503*
2 AWG-750 kcmil	475 A	4	Multiple Port Tap Single Sided Entry	4	5.38	2.70	3.00	3/8	BIBS7504*
2 AWG-750 kcmil	475 A	6	Multiple Port Tap Single Sided Entry	4	8.13	2.70	3.00	3/8	BIBS7506*
2 AWG-750 kcmil	475 A	8	Multiple Port Tap Single Sided Entry	4	10.88	2.70	3.00	3/8	BIBS7508*
2 AWG-750 kcmil	475 A	10	Multiple Port Tap Single Sided Entry	4	13.63	2.70	3.00	3/8	BIBS75010*
2 AWG-750 kcmil	475 A	12	Multiple Port Tap Single Sided Entry	4	16.38	2.70	3.00	3/8	BIBS75012*
2 AWG-750 kcmil	475 A	14	Multiple Port Tap Single Sided Entry	4	19.13	2.70	3.00	3/8	BIBS75014*

Only 1 conductor per port allowed

*Not UL Listed

UNITAP™ Clear Insulated Multi-Port Connectors
for Code Conductor; Double-Sided Entry

Clear Insulated Multiple Tap Connectors



Type BIBD Multi-Port, Double-Sided Tap connectors for quick, easy tap connections for code conductor. UL486B Listed. Dual-rated AL9CU for any stranded copper or stranded aluminum applications. 600 Volt, 90° C. Featuring multiple configurations suitable for most any application.

Multiple Port Tap Double Sided Entry
Figure 5

Wire Range (AWG/kcmil)	Amp Rating	# of Ports	Configuration	Fig. #	Size (inches)			Hex Key	Catalog Number
					L	W	H		
14 AWG-4 Str	85 A	2	Multiple Port Tap Double Sided Entry	5	1.08	1.50	1.25	1/8	BIBD42
14 AWG-4 Str	85 A	3	Multiple Port Tap Double Sided Entry	5	1.51	1.50	1.25	1/8	BIBD43
14 AWG-4 Str	85 A	4	Multiple Port Tap Double Sided Entry	5	1.95	1.50	1.25	1/8	BIBD44
14 AWG-4 Str	85 A	5	Multiple Port Tap Double Sided Entry	5	2.39	1.50	1.25	1/8	BIBD45
14 AWG-4 Str	85 A	6	Multiple Port Tap Double Sided Entry	5	2.83	1.50	1.25	1/8	BIBD46
14 AWG-4 Str	85 A	8	Multiple Port Tap Double Sided Entry	5	3.71	1.50	1.25	1/8	BIBD48
14 AWG-2/0 Str	175 A	2	Multiple Port Tap Double Sided Entry	5	1.52	1.56	1.38	3/16	BIBD2/02
14 AWG-2/0 Str	175 A	3	Multiple Port Tap Double Sided Entry	5	2.19	1.56	1.38	3/16	BIBD2/03
14 AWG-2/0 Str	175 A	4	Multiple Port Tap Double Sided Entry	5	2.86	1.56	1.38	3/16	BIBD2/04
14 AWG-2/0 Str	175 A	5	Multiple Port Tap Double Sided Entry	5	3.53	1.56	1.38	3/16	BIBD2/05
14 AWG-2/0 Str	175 A	6	Multiple Port Tap Double Sided Entry	5	4.20	1.56	1.38	3/16	BIBD2/06
14 AWG-2/0 Str	175 A	8	Multiple Port Tap Double Sided Entry	5	5.55	1.56	1.38	3/16	BIBD2/08
14 AWG-2/0 Str	175 A	10	Multiple Port Tap Double Sided Entry	5	6.89	1.56	1.38	3/16	BIBD2/010
14 AWG-2/0 Str	175 A	12	Multiple Port Tap Double Sided Entry	5	8.24	1.56	1.38	3/16	BIBD2/012
14 AWG-2/0 Str	175 A	14	Multiple Port Tap Double Sided Entry	5	9.58	1.56	1.38	3/16	BIBD2/014
10 AWG-250 kcmil	255 A	2	Multiple Port Tap Double Sided Entry	5	2.03	2.64	2.13	5/16	BIBD2502
10 AWG-250 kcmil	255 A	3	Multiple Port Tap Double Sided Entry	5	2.97	2.64	2.13	5/16	BIBD2503
10 AWG-250 kcmil	255 A	4	Multiple Port Tap Double Sided Entry	5	3.91	2.64	2.13	5/16	BIBD2504
10 AWG-250 kcmil	255 A	5	Multiple Port Tap Double Sided Entry	5	4.84	2.64	2.13	5/16	BIBD2505
10 AWG-250 kcmil	255 A	6	Multiple Port Tap Double Sided Entry	5	5.78	2.64	2.13	5/16	BIBD2506
10 AWG-250 kcmil	255 A	8	Multiple Port Tap Double Sided Entry	5	7.66	2.64	2.13	5/16	BIBD2508
10 AWG-250 kcmil	255 A	10	Multiple Port Tap Double Sided Entry	5	9.53	2.64	2.13	5/16	BIBD25010
10 AWG-250 kcmil	255 A	12	Multiple Port Tap Double Sided Entry	5	11.41	2.64	2.13	5/16	BIBD25012
10 AWG-250 kcmil	255 A	14	Multiple Port Tap Double Sided Entry	5	13.29	2.64	2.13	5/16	BIBD25014

UNITAP™ (Continued)

Wire Range (AWG/kcmil)	Amp Rating	# of Ports	Configuration	Fig. #	Size (inches)			Hex Key	Catalog Number
					L	W	H		
10 AWG-350 kcmil	310 A	2	Multiple Port Tap Double Sided Entry	5	2.22	3.00	2.50	5/16	BIBD3502
10 AWG-350 kcmil	310 A	3	Multiple Port Tap Double Sided Entry	5	3.13	3.00	2.50	5/16	BIBD3503
10 AWG-350 kcmil	310 A	4	Multiple Port Tap Double Sided Entry	5	4.04	3.00	2.50	5/16	BIBD3504
10 AWG-350 kcmil	310 A	5	Multiple Port Tap Double Sided Entry	5	4.95	3.00	2.50	5/16	BIBD3505
10 AWG-350 kcmil	310 A	6	Multiple Port Tap Double Sided Entry	5	5.86	3.00	2.50	5/16	BIBD3506
10 AWG-350 kcmil	310 A	8	Multiple Port Tap Double Sided Entry	5	7.68	3.00	2.50	5/16	BIBD3508
10 AWG-350 kcmil	310 A	10	Multiple Port Tap Double Sided Entry	5	9.5	3.00	2.50	5/16	BIBD35010
10 AWG-350 kcmil	310 A	12	Multiple Port Tap Double Sided Entry	5	11.32	3.00	2.50	5/16	BIBD35012
10 AWG-350 kcmil	310 A	14	Multiple Port Tap Double Sided Entry	5	13.14	3.00	2.50	5/16	BIBD35014
4 AWG-600 kcmil	420 A	2	Multiple Port Tap Double Sided Entry	5	2.56	3.00	2.75	3/8	BIBD6002
4 AWG-600 kcmil	420 A	3	Multiple Port Tap Double Sided Entry	5	3.77	3.00	2.75	3/8	BIBD6003
4 AWG-600 kcmil	420 A	4	Multiple Port Tap Double Sided Entry	5	4.97	3.00	2.75	3/8	BIBD6004
4 AWG-600 kcmil	420 A	5	Multiple Port Tap Double Sided Entry	5	6.17	3.00	2.75	3/8	BIBD6005
4 AWG-600 kcmil	420 A	6	Multiple Port Tap Double Sided Entry	5	7.37	3.00	2.75	3/8	BIBD6006
4 AWG-600 kcmil	420 A	8	Multiple Port Tap Double Sided Entry	5	9.78	3.00	2.75	3/8	BIBD6008
4 AWG-600 kcmil	420 A	10	Multiple Port Tap Double Sided Entry	5	12.97	3.00	2.75	3/8	BIBD60010
4 AWG-600 kcmil	420 A	12	Multiple Port Tap Double Sided Entry	5	15.53	3.00	2.75	3/8	BIBD60012
4 AWG-600 kcmil	420 A	14	Multiple Port Tap Double Sided Entry	5	18.09	3.00	2.75	3/8	BIBD60014
2 AWG-750 kcmil	475 A	2	Multiple Port Tap Double Sided Entry	5	2.87	3.38	3.00	3/8	BIBD7502*
2 AWG-750 kcmil	475 A	3	Multiple Port Tap Double Sided Entry	5	4.25	3.38	3.00	3/8	BIBD7503*
2 AWG-750 kcmil	475 A	4	Multiple Port Tap Double Sided Entry	5	5.63	3.38	3.00	3/8	BIBD7504*
2 AWG-750 kcmil	475 A	6	Multiple Port Tap Double Sided Entry	5	8.37	3.38	3.00	3/8	BIBD7506*
2 AWG-750 kcmil	475 A	8	Multiple Port Tap Double Sided Entry	5	11.13	3.38	3.00	3/8	BIBD7508*
2 AWG-750 kcmil	475 A	10	Multiple Port Tap Double Sided Entry	5	13.87	3.38	3.00	3/8	BIBD75010*
2 AWG-750 kcmil	475 A	12	Multiple Port Tap Double Sided Entry	5	16.63	3.38	3.00	3/8	BIBD75012*
2 AWG-750 kcmil	475 A	14	Multiple Port Tap Double Sided Entry	5	19.37	3.38	3.00	3/8	BIBD75014*

Only 1 conductor per port allowed

*Not UL Listed

UNITAP™ Clear Insulated Multi-Port Connectors for Code Conductor; Mountable; Single-Sided Entry

Clear Insulated Multiple Tap Connectors

Type BIBS-MT Multi-Port, Single-Sided Tap connectors offer the same features as the standard Type BIBS UNITAP™ connectors except these -MT types are provided with two isolated mounting holes, one at each side of the connector for direct mounting to trough, gutter, or wireway. They will accommodate up to standard 1/4" hardware. UL486B Listed. Dual-rated AL9CU for any stranded copper or stranded aluminum applications. 600 Volt, 90° C.



Multiple Port Mounted Tap
Single Sided Entry
Figure 6



Wire Range (AWG/kcmil)	Amp Rating	# of Ports	Configuration	Fig. #	Size (inches)			Hex Key	Catalog Number
					L	W	H		
14 AWG-2/0 Str	175 A	4	Multiple Port Mountable Tap Single Sided Entry	6	4.20	1.25	1.50	3/16	BIBS2/04MT
14 AWG-2/0 Str	175 A	6	Multiple Port Mountable Tap Single Sided Entry	6	5.54	1.25	1.50	3/16	BIBS2/06MT
14 AWG-2/0 Str	175 A	8	Multiple Port Mountable Tap Single Sided Entry	6	6.89	1.25	1.50	3/16	BIBS2/08MT
14 AWG-2/0 Str	175 A	10	Multiple Port Mountable Tap Single Sided Entry	6	8.23	1.25	1.50	3/16	BIBS2/010MT
14 AWG-2/0 Str	175 A	12	Multiple Port Mountable Tap Single Sided Entry	6	9.58	1.25	1.50	3/16	BIBS2/012MT
10 AWG-250 kcmil	255 A	4	Multiple Port Mountable Tap Single Sided Entry	6	5.78	1.95	2.63	5/16	BIBS2504MT
10 AWG-250 kcmil	255 A	6	Multiple Port Mountable Tap Single Sided Entry	6	7.65	1.95	2.63	5/16	BIBS2506MT
10 AWG-250 kcmil	255 A	8	Multiple Port Mountable Tap Single Sided Entry	6	9.53	1.95	2.63	5/16	BIBS2508MT
10 AWG-250 kcmil	255 A	10	Multiple Port Mountable Tap Single Sided Entry	6	11.41	1.95	2.63	5/16	BIBS25010MT
10 AWG-250 kcmil	255 A	12	Multiple Port Mountable Tap Single Sided Entry	6	13.28	1.95	2.63	5/16	BIBS25012MT
10 AWG-350 kcmil	310 A	4	Multiple Port Mountable Tap Single Sided Entry	6	5.86	2.19	2.63	5/16	BIBS3504MT
10 AWG-350 kcmil	310 A	6	Multiple Port Mountable Tap Single Sided Entry	6	7.68	2.19	2.63	5/16	BIBS3506MT
10 AWG-350 kcmil	310 A	8	Multiple Port Mountable Tap Single Sided Entry	6	9.50	2.19	2.63	5/16	BIBS3508MT
10 AWG-350 kcmil	310 A	10	Multiple Port Mountable Tap Single Sided Entry	6	11.32	2.19	2.63	5/16	BIBS35010MT
10 AWG-350 kcmil	310 A	12	Multiple Port Mountable Tap Single Sided Entry	6	13.41	2.19	2.63	5/16	BIBS35012MT
4 AWG-600 kcmil	420 A	4	Multiple Port Mountable Tap Single Sided Entry	6	7.84	2.25	2.88	3/8	BIBS6004MT
4 AWG-600 kcmil	420 A	6	Multiple Port Mountable Tap Single Sided Entry	6	10.41	2.25	2.88	3/8	BIBS6006MT
4 AWG-600 kcmil	420 A	8	Multiple Port Mountable Tap Single Sided Entry	6	12.97	2.25	2.88	3/8	BIBS6008MT
4 AWG-600 kcmil	420 A	10	Multiple Port Mountable Tap Single Sided Entry	6	15.53	2.25	2.88	3/8	BIBS60010MT
4 AWG-600 kcmil	420 A	12	Multiple Port Mountable Tap Single Sided Entry	6	18.09	2.25	2.88	3/8	BIBS60012MT

Only 1 conductor per port allowed

UNITAP™ Clear Insulated Multi-Tap Connectors for Code Conductor; Mountable; Double-Sided Entry

Clear Insulated Multiple Tap Connectors

Type BIBD-MT Multi-Port, Double-Sided Tap connectors offer the same features as the standard Type BIBD UNITAP™ connectors except these -MT types are provided with two isolated mounting holes, one at each side of the connector for direct mounting to trough, gutter, or wireway. They will accommodate up to standard 1/4" hardware. UL486B Listed. Dual-rated AL9CU for any stranded copper or stranded aluminum applications. 600 Volt, 90° C.

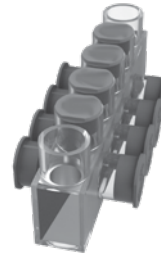

Multiple Port Mounted Tap
Double Sided Entry
Figure 7



Wire Range (AWG/kcmil)	Amp Rating	# of Ports	Configuration	Fig. #	Size (inches)			Hex Key	Catalog Number
					L	W	H		
14 AWG-2/0 AWG	175 A	4	Multiple Port Mountable Tap Double Sided Entry	7	4.20	1.56	1.50	3/16	BIBD2/04MT
14 AWG-2/0 AWG	175 A	6	Multiple Port Mountable Tap Double Sided Entry	7	5.54	1.56	1.50	3/16	BIBD2/06MT
14 AWG-2/0 AWG	175 A	8	Multiple Port Mountable Tap Double Sided Entry	7	6.89	1.56	1.50	3/16	BIBD2/08MT
14 AWG-2/0 AWG	175 A	10	Multiple Port Mountable Tap Double Sided Entry	7	8.23	1.56	1.50	3/16	BIBD2/010MT
14 AWG-2/0 AWG	175 A	12	Multiple Port Mountable Tap Double Sided Entry	7	9.58	1.56	1.50	3/16	BIBD2/012MT
10 AWG-250 kcmil	255 A	4	Multiple Port Mountable Tap Double Sided Entry	7	5.78	2.64	2.26	5/16	BIBD2504MT
10 AWG-250 kcmil	255 A	6	Multiple Port Mountable Tap Double Sided Entry	7	7.65	2.64	2.26	5/16	BIBD2506MT
10 AWG-250 kcmil	255 A	8	Multiple Port Mountable Tap Double Sided Entry	7	9.53	2.64	2.26	5/16	BIBD2508MT
10 AWG-250 kcmil	255 A	10	Multiple Port Mountable Tap Double Sided Entry	7	11.41	2.64	2.26	5/16	BIBD25010MT
10 AWG-250 kcmil	255 A	12	Multiple Port Mountable Tap Double Sided Entry	7	13.28	2.64	2.26	5/16	BIBD25012MT
10 AWG-350 kcmil	310 A	4	Multiple Port Mountable Tap Double Sided Entry	7	5.86	3.00	2.63	5/16	BIBD3504MT
10 AWG-350 kcmil	310 A	6	Multiple Port Mountable Tap Double Sided Entry	7	7.68	3.00	2.63	5/16	BIBD3506MT
10 AWG-350 kcmil	310 A	8	Multiple Port Mountable Tap Double Sided Entry	7	9.5	3.00	2.63	5/16	BIBD3508MT
10 AWG-350 kcmil	310 A	10	Multiple Port Mountable Tap Double Sided Entry	7	11.32	3.00	2.63	5/16	BIBD35010MT
10 AWG-350 kcmil	310 A	12	Multiple Port Mountable Tap Double Sided Entry	7	13.41	3.00	2.63	5/16	BIBD35012MT
4 AWG-600 kcmil	420 A	4	Multiple Port Mountable Tap Double Sided Entry	7	7.84	3	2.88	3/8	BIBD6004MT
4 AWG-600 kcmil	420 A	6	Multiple Port Mountable Tap Double Sided Entry	7	10.41	3	2.88	3/8	BIBD6006MT
4 AWG-600 kcmil	420 A	8	Multiple Port Mountable Tap Double Sided Entry	7	12.97	3	2.88	3/8	BIBD6008MT
4 AWG-600 kcmil	420 A	10	Multiple Port Mountable Tap Double Sided Entry	7	15.53	3	2.88	3/8	BIBD60010MT
4 AWG-600 kcmil	420 A	12	Multiple Port Mountable Tap Double Sided Entry	7	18.09	3	2.88	3/8	BIBD60012MT

Only 1 conductor per port allowed

UNITAP™ Clear Insulated
Multi-Tap Connectors for
Code and Flex Conductors



UL Listed 486A-486B

UNITAP™ Clear Insulated Multi-Tap is UL Listed to the UL Wire Connector Standard UL486A-486B and CSA Certified for use with flexible (fine stranded) conductor - with no ferrules required! Featuring color coordinated conductor port and screw port caps making it easy to identify the maximum conductor size accommodated by the connector.

A disc-pad screw has also been incorporated to prevent damage to the fine strands as the conductor is compressed during installation. The connectors are shipped with the 'pad' attached to the screw by a thin stem; during installation the pad is sheared from the stem as it makes contact with the conductor and remains stationary as the screw continues to rotate until the recommended installation torque is achieved.

The color coordinated conductor port caps display the wire range and classes of conductor accepted by the specific connector. The screw port caps show the installation torque information for quick and easy reference during installation. (Excluding the Heavy Duty 750 Series.)

The Heavy Duty 750 Series features two screws per conductor. Conductors cannot be installed from opposite sides of the same port using only one screw per conductor.



Features & Benefits

- 600 Volt Rated
- Fully Insulated Aluminum 6061-T6 connector body saves time and lowers installation costs by eliminating the need for taping
- Listed to UL486A-B (File E9498)
- CSA Certified to C22.2, No. 65 (File 042860_c_00)
- Rated for use with flex conductor (No Ferrules Required!)
- AL9CU dual rated for use with copper and aluminum conductors
- Range taking designs will accommodate wire sizes from #14-750 kcmil Class B & C, and #14-777 DLO Flex
- Configurations include Taps, In-Line Splice Reducers, Single-Sided Entry, and Double-Sided Entry with the number of ports from 2 to 14
- Clear Plastisol Insulation allows visual confirmation that conductor is properly inserted into port
- Operating temperature from -40°C to 135°C
- Conductor ports are pre-filled with oxide inhibitor
- Screw Port and Conductor Port caps provided to protect against contamination and accidental contact of energized parts
- Caps are color coordinated to quickly identify maximum conductor size accommodated
- Screw Port caps contain recommended installation torque values for quick and easy reference
- Conductor Port caps contain the accommodated wire range and allowable conductor classes



Figure 1

In-Line Splice Reducer
(BISR1/0FX)



Figure 2

Tap - Opposite Side
Entry
(BITO2/0FX)



Figure 4

Multiple Port Tap
Single Sided Entry
(BIBS2/03FX)



Figure 6

Multiple Port
Mounted Tap
Single Sided Entry
(BIBS2504FXMT)



Figure 3

Tap - Same Side Entry
(BIT4FX)



Figure 5

Multiple Port Tap
Double Sided Entry
(BIBD2503FX)



Figure 7

Multiple Port
Mounted Tap
Double Sided Entry
(BIBD6004FXMT)

UNITAP™ Clear Insulated In-Line Splice/Reducer Connectors for Code and Flex Conductor

Clear Insulated In-Line Splice/Reducer Connectors



In-Line Splice Reducer
Figure 1
(BISR1/0FX)

Type BISR-FX in-line splice/reductions are made quickly and easily with the UNITAP™ line of clear insulated connectors for code and flex conductor. UL486B Listed. Dual-rated AL9CU for any stranded copper or stranded aluminum applications. 600 Volt, 90° C. The UNITAP™ line for code and flex conductor features color-coordinated conductor port caps that display the wire range and classes of conductor accepted by the specific connector. The screw port caps show the installation torque information for quick and easy reference during installation.

Wire Range (AWG/kcmil)	Amp Rating	# of Ports	Configuration	Fig. #	Size (inches)			Hex Key	Catalog Number	Cap Color
					Length	Width	Height			
#14-#2 Class B & C #14-#2 Class G,H,I,K, DLO	130 A	2	In-Line Splice Reducer	1	2.38	0.75	1.22	5/32	BISR2FX	Brown
#14-1/0 Class B & C #14-#1 Class G,H,I,K, DLO	170 A	2	In-Line Splice Reducer	1	2.91	0.75	1.22	3/16	BISR1/0FX	Pink
#10-250 Class B & C #10-3/0 Class G,H,I,K, DLO	290 A	2	In-Line Splice Reducer	1	4.01	1.19	2.10	5/16	BISR250FX	Yellow
#10-350 Class B & C #10-250 Class G,H,I,K, DLO	350 A	2	In-Line Splice Reducer	1	4.63	1.34	2.35	5/16	BISR350FX	Red
#6-500 Class B & C #6-373 Class G,H,I,K, DLO	430 A	2	In-Line Splice Reducer	1	5.00	1.62	2.62	3/8	BISR500FX	Brown
* 1/0-750 Class B & C 1/0-777 Class G,H,I,K, DLO	475 A	2	In-Line Splice Reducer	1	5.89	2.00	3.88	5/16	BISR750HDFX	Red

* Heavy Duty Series: two screws per conductor; conductors **cannot** be installed from opposite sides of the same port using only one screw per conductor.

UNITAP™ Clear Insulated Multi-Tap
Connectors for Code Conductor

Clear Insulated In-Line Multi-Tap Connectors



Type BIT-FX and BITO-FX (Offset) Multi-Tap connectors are installed quickly and easily and are suitable for use on flex and code conductor. UL486B Listed. Dual-rated AL9CU for any stranded copper or stranded aluminum applications. 600 Volt, 90° C.



Tap - Opposite Side Entry
Figure 2
(BITO2/0FX)



Tap - Same Side Entry
Figure 3
(BIT4FX)

Wire Range (AWG/kcmil)	Amp Rating	# of Ports	Configuration	Fig. #	Size (inches)			Hex Key	Catalog Number	Cap Color
					Length	Width	Height			
#14-#4 Class B & C #14-#6 Class G,H,I,K, DLO	95 A	2	Tap - Opposite Side Entry	2	1.08	1.50	1.25	1/8	BITO4FX	Brown
			Tap - Same Side Entry	3	1.08	1.16	1.25	1/8	BIT4FX	
#14-2/0 Class B & C #14-#1 Class G,H,I,K, DLO	195 A	2	Tap - Opposite Side Entry	2	1.52	1.56	1.38	3/16	BITO2/0FX	Black
			Tap - Same Side Entry	3	1.52	1.40	1.38	3/16	BIT2/0FX	
#10-250 Class B & C #10-3/0 Class G,H,I,K, DLO	290 A	2	Tap - Opposite Side Entry	2	2.03	2.64	2.13	5/16	BITO250FX	Yellow
			Tap - Same Side Entry	3	2.03	2.07	2.13	5/16	BIT250FX	
#10-350 Class B & C #10-250 Class G,H,I,K, DLO	350 A	2	Tap - Opposite Side Entry	2	2.22	3.00	2.50	5/16	BITO350FX	Red
			Tap - Same Side Entry	3	2.22	2.32	2.50	5/16	BIT350FX	
#4-600 Class B & C #4-373 Class G,H,I,K, DLO	475 A	2	Tap - Opposite Side Entry	2	2.72	3.00	2.75	3/8	BITO600FX	Green
			Tap - Same Side Entry	3	2.72	2.38	2.75	3/8	BIT600FX	
* 1/0-750 Class B & C 1/0-777 Class G,H,I,K, DLO	475 A	2	Tap - Opposite Side Entry	2	3.75	3.25	3.88	5/16	BITO750HDFX	Red
			Tap - Same Side Entry	3	3.75	3.25	3.88	5/16	BIT750HDFX	

* Heavy Duty Series: two screws per conductor; conductors cannot be installed from opposite sides of the same port using only one screw per conductor.

UNITAP™ Clear Insulated Multi-Port Connectors for Code and Flex Conductor; Single-Sided Entry

Clear Insulated Multi-Port Connectors

Type BIBS-FX Multi-Port, Single-Sided Tap connectors for quick, easy tap connections for code and flex conductor. UL486B Listed. Dual-rated AL9CU for any stranded copper or stranded aluminum applications. 600 Volt, 90° C. The UNITAP™ line for code and flex conductor features color-coordinated conductor port caps that display the wire range and classes of conductor accepted by the specific connector. The screw port caps show the installation torque information for quick and easy reference during installation.



Multiple Port Tap Single Sided Entry
Figure 4
(BIBS2/03FX)

Wire Range (AWG/kcmil)	Amp Rating	# of Ports	Configuration	Fig. #	Size (inches)			Hex Key	Catalog Number	Cap Color
					Length	Width	Height			
#14-#4 Class B & C #14-#6 Class G,H,I,K, DLO	95 A	3	Single Sided Entry	4	1.51	1.16	1.25	1/8	BIBS43FX	Brown
		4	Single Sided Entry	4	1.95	1.16	1.25	1/8	BIBS44FX	
		5	Single Sided Entry	4	2.39	1.16	1.25	1/8	BIBS45FX	
		6	Single Sided Entry	4	2.83	1.16	1.25	1/8	BIBS46FX	
		8	Single Sided Entry	4	3.71	1.16	1.25	1/8	BIBS48FX	
#14-2/0 Class B & C #14-#1 Class G,H,I,K, DLO	195 A	3	Single Sided Entry	4	2.19	1.31	1.38	3/16	BIBS2/03FX	Black
		4	Single Sided Entry	4	2.86	1.31	1.38	3/16	BIBS2/04FX	
		5	Single Sided Entry	4	3.53	1.31	1.38	3/16	BIBS2/05FX	
		6	Single Sided Entry	4	4.20	1.31	1.38	3/16	BIBS2/06FX	
		8	Single Sided Entry	4	5.55	1.31	1.38	3/16	BIBS2/08FX	
		10	Single Sided Entry	4	6.89	1.31	1.38	3/16	BIBS2/010FX	
		12	Single Sided Entry	4	8.24	1.31	1.38	3/16	BIBS2/012FX	
#10-250 Class B & C #10-3/0 Class G,H,I,K, DLO	290 A	3	Single Sided Entry	4	2.97	2.07	2.13	5/16	BIBS2503FX	Yellow
		4	Single Sided Entry	4	3.91	2.07	2.13	5/16	BIBS2504FX	
		5	Single Sided Entry	4	4.84	2.07	2.13	5/16	BIBS2505FX	
		6	Single Sided Entry	4	5.78	2.07	2.13	5/16	BIBS2506FX	
		8	Single Sided Entry	4	7.66	2.07	2.13	5/16	BIBS2508FX	
		10	Single Sided Entry	4	9.53	2.07	2.13	5/16	BIBS25010FX	
		12	Single Sided Entry	4	11.41	2.07	2.13	5/16	BIBS25012FX	
#10-350 Class B & C #10-250 Class G,H,I,K, DLO	350 A	3	Single Sided Entry	4	3.13	2.32	2.50	5/16	BIBS3503FX	Red
		4	Single Sided Entry	4	4.04	2.32	2.50	5/16	BIBS3504FX	
		5	Single Sided Entry	4	4.95	2.32	2.50	5/16	BIBS3505FX	
		6	Single Sided Entry	4	5.86	2.32	2.50	5/16	BIBS3506FX	
		8	Single Sided Entry	4	7.68	2.32	2.50	5/16	BIBS3508FX	
		10	Single Sided Entry	4	9.50	2.32	2.50	5/16	BIBS35010FX	
		12	Single Sided Entry	4	11.32	2.32	2.50	5/16	BIBS35012FX	
		14	Single Sided Entry	4	13.14	2.32	2.50	5/16	BIBS35014FX	

UNITAP™ (Continued)

Wire Range (AWG/kcmil)	Amp Rating	# of Ports	Configuration	Fig. #	Size (inches)			Hex Key	Catalog Number	Cap Color
					Length	Width	Height			
#4-600 Class B & C #4-373 Class G,H,I,K, DLO	475 A	3	Single Sided Entry	4	4.00	2.38	2.75	3/8	BIBS6003FX	Green
		4	Single Sided Entry	4	5.28	2.38	2.75	3/8	BIBS6004FX	
		5	Single Sided Entry	4	6.56	2.38	2.75	3/8	BIBS6005FX	
		6	Single Sided Entry	4	7.84	2.38	2.75	3/8	BIBS6006FX	
		8	Single Sided Entry	4	10.41	2.38	2.75	3/8	BIBS6008FX	
		10	Single Sided Entry	4	12.97	2.38	2.75	3/8	BIBS60010FX	
		12	Single Sided Entry	4	15.53	2.38	2.75	3/8	BIBS60012FX	
		14	Single Sided Entry	4	18.09	2.38	2.75	3/8	BIBS60014FX	
* 1/0-750 Class B & C 1/0-777 Class G,H,I,K, DLO	475 A	3	Single Sided Entry	4	5.50	3.25	3.88	5/16	BIBS7503HDFX	Red
		4	Single Sided Entry	4	7.25	3.25	3.88	5/16	BIBS7504HDFX	
		6	Single Sided Entry	4	10.75	3.25	3.88	5/16	BIBS7506HDFX	
		8	Single Sided Entry	4	14.25	3.25	3.88	5/16	BIBS7508HDFX	
		10	Single Sided Entry	4	17.75	3.25	3.88	5/16	BIBS75010HDFX	
		12	Single Sided Entry	4	21.25	3.25	3.88	5/16	BIBS75012HDFX	
		14	Single Sided Entry	4	24.75	3.25	3.88	5/16	BIBS75014HDFX	

* Heavy Duty Series: two screws per conductor; conductors cannot be installed from opposite sides of the same port using only one screw per conductor.

UNITAP™ Clear Insulated Multi-Port Connectors for Code and Flex Conductor; Double-Sided Entry

Clear Insulated Multi-Port Connectors

Type BIBD-FX Multi-Port, Double-Sided Tap connectors for quick, easy tap connections for code and flex conductor. UL486B Listed. Dual-rated AL9CU for any stranded copper or stranded aluminum applications. 600 Volt, 90° C. The UNITAP™ line for code and flex conductor features color-coordinated conductor port caps that display the wire range and classes of conductor accepted by the specific connector. The screw port caps show the installation torque information for quick and easy reference during installation.



Multiple Port Tap Double Sided Entry
Figure 5
(BIBD2503FX)

Wire Range (AWG/kcmil)	Amp Rating	# of Ports	Configuration	Fig. #	Size (inches)			Hex Key	Catalog Number	Cap Color
					Length	Width	Height			
#14-#4 Class B & C #14-#6 Class G,H,I,K, DLO	95 A	2	Double Sided Entry	5	1.08	1.50	1.25	1/8	BIBD42FX	Brown
		3	Double Sided Entry	5	1.51	1.50	1.25	1/8	BIBD43FX	
		4	Double Sided Entry	5	1.95	1.50	1.25	1/8	BIBD44FX	
		5	Double Sided Entry	5	2.39	1.50	1.25	1/8	BIBD45FX	
		6	Double Sided Entry	5	2.83	1.50	1.25	1/8	BIBD46FX	
		8	Double Sided Entry	5	3.71	1.50	1.25	1/8	BIBD48FX	
#14-2/0 Class B & C #14-#1 Class G,H,I,K, DLO	195 A	2	Double Sided Entry	5	1.52	1.56	1.38	3/16	BIBD2/02FX	Black
		3	Double Sided Entry	5	2.19	1.56	1.38	3/16	BIBD2/03FX	
		4	Double Sided Entry	5	2.86	1.56	1.38	3/16	BIBD2/04FX	
		5	Double Sided Entry	5	3.53	1.56	1.38	3/16	BIBD2/05FX	
		6	Double Sided Entry	5	4.20	1.56	1.38	3/16	BIBD2/06FX	
		8	Double Sided Entry	5	5.55	1.56	1.38	3/16	BIBD2/08FX	
		10	Double Sided Entry	5	6.89	1.56	1.38	3/16	BIBD2/010FX	
		12	Double Sided Entry	5	8.24	1.56	1.38	3/16	BIBD2/012FX	
#10-250 Class B & C #10-3/0 Class G,H,I,K, DLO	290 A	2	Double Sided Entry	5	2.03	2.64	2.13	5/16	BIBD2502FX	Yellow
		3	Double Sided Entry	5	2.97	2.64	2.13	5/16	BIBD2503FX	
		4	Double Sided Entry	5	3.91	2.64	2.13	5/16	BIBD2504FX	
		5	Double Sided Entry	5	4.84	2.64	2.13	5/16	BIBD2505FX	
		6	Double Sided Entry	5	5.78	2.64	2.13	5/16	BIBD2506FX	
		8	Double Sided Entry	5	7.66	2.64	2.13	5/16	BIBD2508FX	
		10	Double Sided Entry	5	9.53	2.64	2.13	5/16	BIBD25010FX	
		12	Double Sided Entry	5	11.41	2.64	2.13	5/16	BIBD25012FX	
		14	Double Sided Entry	5	13.29	2.64	2.13	5/16	BIBD25014FX	

UNITAP™ (Continued)

Wire Range (AWG/kcmil)	Amp Rating	# of Ports	Configuration	Fig. #	Size (inches)			Hex Key	Catalog Number	Cap Color
					Length	Width	Height			
#10-350 Class B & C #10-250 Class G,H,I,K, DLO	350 A	2	Double Sided Entry	5	3.13	3.00	2.50	5/16	BIBD3502FX	Red
		3	Double Sided Entry	5	4.04	3.00	2.50	5/16	BIBD3503FX	
		4	Double Sided Entry	5	4.95	3.00	2.50	5/16	BIBD3504FX	
		5	Double Sided Entry	5	5.86	3.00	2.50	5/16	BIBD3505FX	
		6	Double Sided Entry	5	7.68	3.00	2.50	5/16	BIBD3506FX	
		8	Double Sided Entry	5	9.50	3.00	2.50	5/16	BIBD3508FX	
		10	Double Sided Entry	5	11.32	3.00	2.50	5/16	BIBD35010FX	
		12	Double Sided Entry	5	13.14	3.00	2.50	5/16	BIBD35012FX	
#4-600 Class B & C #4-373 Class G,H,I,K, DLO	475 A	2	Double Sided Entry	5	2.72	3.00	2.75	3/8	BIBD6002FX	Green
		3	Double Sided Entry	5	4.00	3.00	2.75	3/8	BIBD6003FX	
		4	Double Sided Entry	5	5.28	3.00	2.75	3/8	BIBD6004FX	
		5	Double Sided Entry	5	6.56	3.00	2.75	3/8	BIBD6005FX	
		6	Double Sided Entry	5	7.84	3.00	2.75	3/8	BIBD6006FX	
		8	Double Sided Entry	5	10.41	3.00	2.75	3/8	BIBD6008FX	
		10	Double Sided Entry	5	12.97	3.00	2.75	3/8	BIBD60010FX	
		12	Double Sided Entry	5	15.53	3.00	2.75	3/8	BIBD60012FX	
* 1/0-750 Class B & C 1/0-777 Class G,H,I,K, DLO	475 A	2	Double Sided Entry	5	3.75	3.25	3.88	5/16	BIBD7502HDFX	Red
		3	Double Sided Entry	5	5.50	3.25	3.88	5/16	BIBD7503HDFX	
		4	Double Sided Entry	5	7.25	3.25	3.88	5/16	BIBD7504HDFX	
		6	Double Sided Entry	5	10.75	3.25	3.88	5/16	BIBD7506HDFX	
		8	Double Sided Entry	5	14.25	3.25	3.88	5/16	BIBD7508HDFX	
		10	Double Sided Entry	5	17.75	3.25	3.88	5/16	BIBD75010HDFX	
		12	Double Sided Entry	5	21.25	3.25	3.88	5/16	BIBD75012HDFX	
		14	Double Sided Entry	5	24.75	3.25	3.88	5/16	BIBD75014HDFX	

* Heavy Duty Series: two screws per conductor; conductors cannot be installed from opposite sides of the same port using only one screw per conductor.

UNITAP™ Clear Insulated Multi-Port Connectors for Code and Flex Conductor; Mountable; Single-Sided Entry

Clear Insulated Multiple Tap Connectors



Multiple Port Mounted Tap
Single Sided Entry
Figure 6
(BIBS2504FXMT)

Type BIBS-FXMT Multi-Port, Single-Sided Tap connectors offer the same features as the standard Type BIBS-FX UNITAP™ connectors except these -FXMT types are provided with two isolated mounting holes, one at each side of the connector for direct mounting to trough, gutter, or wireway. They will accommodate up to standard 1/4" hardware. UL486B Listed. Dual-rated AL9CU for any stranded copper or stranded aluminum applications. 600 Volt, 90° C.

Wire Range (AWG/kcmil)	Amp Rating	# of Ports	Configuration	Fig. #	Size (inches)			Hex Key	Catalog Number	Cap Color
					Length	Width	Height			
#14-2/0 Class B & C #14-#1 Class G,H,I,K, DLO	195 A	4	Mountable Single Sided Entry	6	4.20	1.25	1.50	3/16	BIBS2/04FXMT	Black
		6	Mountable Single Sided Entry	6	5.55	1.25	1.50	3/16	BIBS2/06FXMT	
		8	Mountable Single Sided Entry	6	6.89	1.25	1.50	3/16	BIBS2/08FXMT	
		10	Mountable Single Sided Entry	6	8.24	1.25	1.50	3/16	BIBS2/010FXMT	
		12	Mountable Single Sided Entry	6	9.58	1.25	1.50	3/16	BIBS2/012FXMT	
#10-250 Class B & C #10-3/0 Class G,H,I,K, DLO	290 A	4	Mountable Single Sided Entry	6	5.78	1.95	2.63	5/16	BIBS2504FXMT	Yellow
		6	Mountable Single Sided Entry	6	7.65	1.95	2.63	5/16	BIBS2506FXMT	
		8	Mountable Single Sided Entry	6	9.53	1.95	2.63	5/16	BIBS2508FXMT	
		10	Mountable Single Sided Entry	6	11.41	1.95	2.63	5/16	BIBS25010FXMT	
		12	Mountable Single Sided Entry	6	13.29	1.95	2.63	5/16	BIBS25012FXMT	
#10-350 Class B & C #10-250 Class G,H,I,K, DLO	350 A	4	Mountable Single Sided Entry	6	5.86	2.32	2.63	5/16	BIBS3504FXMT	Red
		6	Mountable Single Sided Entry	6	7.68	2.32	2.63	5/16	BIBS3506FXMT	
		8	Mountable Single Sided Entry	6	9.50	2.32	2.63	5/16	BIBS3508FXMT	
		10	Mountable Single Sided Entry	6	11.32	2.32	2.63	5/16	BIBS35010FXMT	
		12	Mountable Single Sided Entry	6	13.14	2.32	2.63	5/16	BIBS35012FXMT	
#4-600 Class B & C #4-373 Class G,H,I,K, DLO	475 A	4	Mountable Single Sided Entry	6	5.53	2.25	2.88	3/8	BIBS6004FXMT	Green
		6	Mountable Single Sided Entry	6	7.40	2.25	2.88	3/8	BIBS6006FXMT	
		8	Mountable Single Sided Entry	6	9.28	2.25	2.88	3/8	BIBS6008FXMT	
		12	Mountable Single Sided Entry	6	13.03	2.25	2.88	3/8	BIBS60012FXMT	

UNITAP™ Clear Insulated Multi-Port Connectors
for Code and Flex Conductor;
Mountable; Double-Sided Entry

Clear Insulated Multiple Tap Connectors



Multiple Port Mounted Tap
Double Sided Entry
Figure 7
(BIBD6004FXMT)

Type BIBD-FXMT Multi-Port, Double-Sided Tap connectors offer the same features as the standard Type BIBD-FX UNITAP™ connectors except these -FXMT types are provided with two isolated mounting holes, one at each side of the connector for direct mounting to trough, gutter, or wireway. They will accommodate up to standard 1/4" hardware. UL486B Listed. Dual-rated AL9CU for any stranded copper or stranded aluminum applications. 600 Volt, 90° C.

Wire Range (AWG/kcmil)	Amp Rating	# of Ports	Configuration	Fig. #	Size (inches)			Hex Key	Catalog Number	Cap Color
					Length	Width	Height			
#14-2/0 Class B & C #14-#1 Class G,H,I,K, DLO	195 A	4	Mountable Double Sided Entry	7	4.20	1.56	1.50	3/16	BIBD2/04FXMT	Black
		8	Mountable Double Sided Entry	7	6.89	1.56	1.50	3/16	BIBD2/08FXMT	
		10	Mountable Double Sided Entry	7	8.24	1.56	1.50	3/16	BIBD2/010FXMT	
		12	Mountable Double Sided Entry	7	9.58	1.56	1.50	3/16	BIBD2/012FXMT	
		4	Mountable Double Sided Entry	7	5.78	2.64	2.63	5/16	BIBD2504FXMT	
#10-250 Class B & C #10-3/0 Class G,H,I,K, DLO	290 A	6	Mountable Double Sided Entry	7	7.65	2.64	2.63	5/16	BIBSD506FXMT	Yellow
		8	Mountable Double Sided Entry	7	9.53	2.64	2.63	5/16	BIBD2508FXMT	
		10	Mountable Double Sided Entry	7	11.41	2.64	2.63	5/16	BIBD25010FXMT	
		12	Mountable Double Sided Entry	7	13.29	2.64	2.63	5/16	BIBD25012FXMT	
		4	Mountable Double Sided Entry	7	5.86	3.00	2.63	5/16	BIBD3504FXMT	
#10-350 Class B & C #10-250 Class G,H,I,K, DLO	350 A	6	Mountable Double Sided Entry	7	7.68	3.00	2.63	5/16	BIBD3506FXMT	Red
		8	Mountable Double Sided Entry	7	9.50	3.00	2.63	5/16	BIBD3508FXMT	
		10	Mountable Double Sided Entry	7	11.32	3.00	2.63	5/16	BIBD35010FXMT	
		12	Mountable Double Sided Entry	7	13.14	3.00	2.63	5/16	BIBD35012FXMT	
		4	Mountable Double Sided Entry	7	5.53	3.00	2.88	3/8	BIBD6004FXMT	
#4-600 Class B & C #4-373 Class G,H,I,K, DLO	475 A	6	Mountable Double Sided Entry	7	7.40	3.00	2.88	3/8	BIBD6006FXMT	Green
		8	Mountable Double Sided Entry	7	9.28	3.00	2.88	3/8	BIBD6008FXMT	
		10	Mountable Double Sided Entry	7	11.16	3.00	2.88	3/8	BIBD60010FXMT	
		12	Mountable Double Sided Entry	7	13.03	3.00	2.88	3/8	BIBD60012FXMT	

UV Rated Black UNITAP™

UNITAP™



UV Rated Black Insulated Multiple Tap Connectors and Splice Reducers

Tap connections are made quickly and easily with the UNITAP™ line of connectors. UL486A-B Listed. Dual-rated for any stranded copper or stranded aluminum applications. UL Listed 600 Volts, -40° C to 135° C Operating Temperature.

Features & Benefits

- UV Rated covering over AL6061-T6 aluminum body saves time, lowering installation costs and eliminates taping
- Oxide inhibitor pre-installed inhibits moisture and contaminants from entering the contact area
- Range-taking capability reduces the number of connectors necessary to carry in inventory
- AL486B Listed, AL9CU, 600 Volts, 90°C
- Operating temperature -40°C to 135°C



Figure 1

In-Line Splice Reducer
(1PBS1/0)



Figure 4

Multiple Port Tap
Single Sided Entry
(1PL2503)



Figure 2

Tap - Opposite Side
Entry
(1PLO2502)



Figure 5

Multiple Port Tap
Double Sided Entry
(1PLD2504)



Figure 3

Tap - Same Side Entry
(1PL42)



Figure 6

Multiple Port Tap
Double Sided Entry
Heavy Duty 750 Series
(1PLD7504HD)

Wire Range (AWG/kcmil) CLASS B & C ONLY	# of Ports	Configuration	Fig. #	Size (inches)			Hex Key	Catalog Number	Installation Torque (in-lbs)
				Length	Width	Height			
14 AWG-2 AWG	2	In-Line Splice Reducer	1	2.38	0.75	1.22	5/32	1PBS2	45
14 AWG-1/0 AWG				2.91	0.91	1.38	3/16	1PBS1/0	120
10 AWG-250 kcmil				4.01	1.19	2.10	5/16	1PBS250	275
10 AWG-350 kcmil				4.63	1.34	2.35	5/16	1PBS350	275
6 AWG-500 kcmil				5.00	1.62	2.62	3/8	1PBS500	375
* #2 AWG - 750 kcmil				10.53	1.88	3.01	3/8"	1PBS750HD	500
14 AWG-4 AWG	2	Tap - Opposite Side Entry	2	1.08	1.50	1.25	1/8	1PLO42	45
14 AWG-2/0 AWG				1.52	1.56	1.38	3/16	1PLO2/02	120
10 AWG-250 kcmil				2.03	2.64	2.13	5/16	1PLO2502	275
10 AWG-350 kcmil				2.22	3.00	2.5	5/16	1PLO3502	275
4 AWG-600 kcmil				2.72	3.00	2.75	3/8	1PLO6002	375
14 AWG-4 AWG	2	Tap - Same Side Entry	3	1.08	1.16	1.25	1/8	1PL42	45
14 AWG-2/0 AWG				1.52	1.40	1.38	3/16	1PL2/02	120
10 AWG-250 kcmil				2.03	2.07	2.13	5/16	1PL2502	275
10 AWG-350 kcmil				2.22	2.32	2.5	5/16	1PL3502	275
4 AWG-600 kcmil				2.72	2.38	2.75	3/8	1PL6002	375
2 AWG-750 kcmil				2.87	2.70	3.00	3/8	1PL7502†	375

† Not UL Listed

* Heavy Duty Series: two screws per conductor; conductors cannot be installed from opposite sides of the same port using only one screw per conductor.

UV Rated Black UNITAP™ (Continued)

Wire Range (AWG/kcmil) CLASS B & C ONLY	# of Ports	Configuration	Fig. #	Size (inches)			Hex Key	Catalog Number	Installation Torque (in-lbs)
				Length	Width	Height			
14 AWG-4 AWG	3	Single Sided Entry	4	1.51	1.25	1.25	1/8	1PL43	45
	4			1.95	1.25	1.25	1/8	1PL44	
	5			2.39	1.25	1.25	1/8	1PL45	
	6			2.83	1.25	1.25	1/8	1PL46	
	8			3.71	1.25	1.25	1/8	1PL48	
14 AWG-2/0 AWG	3			2.19	1.31	1.38	3/16	1PL2/03	120
	4			2.86	1.31	1.38	3/16	1PL2/04	
	5			3.53	1.31	1.38	3/16	1PL2/05	
	6			4.20	1.31	1.38	3/16	1PL2/06	
	8			5.55	1.31	1.38	3/16	1PL2/08	
10 AWG-250 kcmil	3			2.97	2.07	2.13	5/16	1PL2503	275
	4			3.91	2.07	2.13	5/16	1PL2504	
	5			4.84	2.07	2.13	5/16	1PL2505	
	6			5.78	2.07	2.13	5/16	1PL2506	
	8			7.66	2.07	2.13	5/16	1PL2508	
10 AWG-350 kcmil	3			3.13	2.32	2.50	5/16	1PL3503	275
	4			4.04	2.32	2.50	5/16	1PL3504	
	5			4.95	2.32	2.50	5/16	1PL3505	
	6			5.86	2.32	2.50	5/16	1PL3506	
	8			7.68	2.32	2.50	5/16	1PL3508	
4 AWG-600 kcmil	3	4.00	2.38	2.75	3/8	1PL6003	375		
	4	5.28	2.38	2.75	3/8	1PL6004			
	5	6.56	2.38	2.75	3/8	1PL6005			
	6	7.84	2.38	2.75	3/8	1PL6006			
	8	10.41	2.38	2.75	3/8	1PL6008			
	10	12.97	2.38	2.75	3/8	1PL60010			
2 AWG-750 kcmil	3	4.00	2.70	3.00	3/8	1PL7503†	375		

† Not UL Listed

* Heavy Duty Series: two screws per conductor; conductors cannot be installed from opposite sides of the same port using only one screw per conductor.

UV Rated Black UNITAP™ (Continued)

14 AWG-4 AWG	3	Double Sided Entry	5	1.51	1.50	1.25	1/8	1PLD43	45		
	4			1.95	1.50	1.25	1/8	1PLD44			
	5			2.39	1.50	1.25	1/8	1PLD45			
	6			2.83	1.50	1.25	1/8	1PLD46			
	8			3.71	1.50	1.25	1/8	1PLD48			
14 AWG-2/0 AWG	2					1.52	1.56	1.38	3/16	1PLD2/02	120
	3					2.19	1.56	1.38	3/16	1PLD2/03	
	4					2.86	1.56	1.38	3/16	1PLD2/04	
	6					4.2	1.56	1.38	3/16	1PLD2/06	
10 AWG-250 kcmil	2					2.03	2.64	2.13	5/16	1PLD2502	275
	3					2.97	2.64	2.13	5/16	1PLD2503	
	4					3.91	2.64	2.13	5/16	1PLD2504	
	6					5.78	2.64	2.13	5/16	1PLD2506	
10 AWG-350 kcmil	2					2.22	3.00	2.5	5/16	1PLD3502	275
	3					3.13	3.00	2.5	5/16	1PLD3503	
	4					4.04	3.00	2.5	5/16	1PLD3504	
	6					5.86	3.00	2.5	5/16	1PLD3506	
	8					7.68	3.00	2.5	5/16	1PLD3508	
4 AWG-600 kcmil	2					2.72	3.00	2.75	3/8	1PLD6002	375
	3					4.00	3.00	2.75	3/8	1PLD6003	
	4			5.28	3.00	2.75	3/8	1PLD6004			
	5			6.56	3.00	2.75	3/8	1PLD6005			
	6			7.84	3.00	2.75	3/8	1PLD6006			
	8			10.40	3.00	2.75	3/8	1PLD6008			
* #2 AWG - 750 kcmil	2	Double Sided Entry	6	2.63	4.83	3.00	3/8"	1PLD7502HD	500		
	3			4.00	4.83	3.00	3/8"	1PLD7503HD			
	4			5.38	4.83	3.00	3/8"	1PLD7504HD			
	5			6.75	4.83	3.00	3/8"	1PLD7505HD			
	6			8.13	4.83	3.00	3/8"	1PLD7506HD			
	8			10.88	4.83	3.00	3/8"	1PLD7508HD			
	10			13.63	4.83	3.00	3/8"	1PLD75010HD			
	12			16.38	4.83	3.00	3/8"	1PLD75012HD			

† Not UL Listed

* Heavy Duty Series: two screws per conductor; conductors cannot be installed from opposite sides of the same port using only one screw per conductor.

VERSIPOLE™

UL Listed 1953; Finger-Safe IEC 60527; IP-20 Rating

The VERSIPOLE™ Configurable Series Power Distribution Blocks are used for splicing and distributing power from primary run(s) to secondary/branch circuits. They are offered in standard one, two, or three pole configurations. The configurable series can also be designed to accommodate an infinite number of made-to-order combinations.

Features & Benefits

- 600 Volt rated; Listed to UL1953; Rated for use with both code and flex conductor without requiring ferrules
- AL9CU dual rated for use with copper and aluminum conductors
- Range taking designs accommodate wire sizes up to 535 DLO and can support 1 or 2 run conductors and up to 12 taps for secondary circuits
- Allow for panel mounting; medium and large sizes also allow for DIN rail mounting
- Finger-Safe style are provided with translucent polycarbonate top covers and end plates to permit easy visual inspection and provide IEC 60529 IP-20 Rating
- High Short-Circuit Current rating up to 100kA with proper fusing
- Bases and side barriers of glass-reinforced nylon 6/6 for extra durability and excellent insulating properties; carry a UL94 flammability rating of V0



↑ Figure 1
Open Style
BDBMCS5M1 shown



Figure 2 →
Finger-Safe Style comes
with covers and end plates
BDBMCS5M1FS shown



← Figure 3
Finger-Safe Kits include
only covers and end plates

Ordering Information & Footnotes:

Finger-Safe Kits include translucent top cover and end plates only. Order 1 kit per pole. The kits are used in conjunction with Open style distribution blocks. (Distribution blocks are not included.)

† To achieve Finger-Safe style Adder order Open style Adder and Finger-Safe Kit

Optional Hinged Covers are available for use with Open style blocks and are ordered 1 cover per pole.

Optional Hinged Covers:	
Catalog Number	Size
BDBSCSCOVER	Small
BDBMCSCOVER	Medium
BDBLCSCOVER	Large

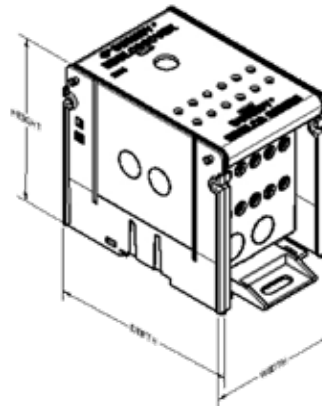

BDBLCS3A1FS shown

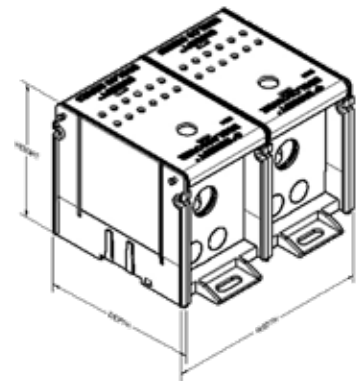

BDBLCS3A2FS shown

Small Series:											
Catalog Number			# of Conductors		Wire Range (Class B, C, H, I, K, DLO)		# of Poles	Dimensions			Amp Rating per Pole
Open Style (Fig. 1)	Finger-Safe Style (Fig. 2)	Finger-Safe Kit (Fig. 3)	Run	Tap	Run	Tap		W	D	H	
BDBSCS1C1	BDBSCS1C1FS	BDBSCS1C1FSKIT	1	4	#14 - 2/0	#14 - #4	1	1.34	3.06	3.59	175
BDBSCS1C2	BDBSCS1C2FS						2	2.41	3.06	3.59	175
BDBSCS1C3	BDBSCS1C3FS						3	3.48	3.06	3.59	175
BDBSCS1CA	†						Adder	1.16	3.06	3.59	175

VERSIPOLE™ (Continued)

Catalog Number			# of Conductors		Wire Range (Class B, C, H, I, K, DLO)		# of Poles	Dimensions			Amp Rating per Pole
Open Style (Fig. 1)	Finger-Safe Style (Fig. 2)	Finger-Safe Kit (Fig. 3)	Run	Tap	Run	Tap		W	D	H	
BDBSCS1P1	BDBSCS1P1FS	BDBSCS1P1FSKIT	1	1	#14 - 2/0	#14 - 2/0	1	1.34	3.06	3.59	175
BDBSCS1P2	BDBSCS1P2FS						2	2.41	3.06	3.59	175
BDBSCS1P3	BDBSCS1P3FS						3	3.48	3.06	3.59	175
BDBSCS1PA	†						Adder	1.16	3.06	3.59	175

Medium Series:											
Open Style	Finger-Safe Style	Finger-Safe Kit	Run	Tap	Run	Tap	# of Poles	W	D	H	Amp Rating
BDBMCS1F1	BDBMCS1F1FS	BDBMCS1F1FSKIT	1	6	#14 - 2/0	#14 - #2	1	2.09	4.52	3.70	175
BDBMCS1F2	BDBMCS1F2FS						2	3.90	4.52	3.70	175
BDBMCS1F3	BDBMCS1F3FS						3	5.72	4.52	3.70	175
BDBMCS1FA	†						Adder	1.91	4.52	3.70	175
BDBMCS3U1	BDBMCS3U1FS	BDBMCS3U1FSKIT	1	1	#6 - 350	#6 - 350	1	2.09	4.52	3.70	310
BDBMCS3U2	BDBMCS3U2FS						2	3.90	4.52	3.70	310
BDBMCS3U3	BDBMCS3U3FS						3	5.72	4.52	3.70	310
BDBMCS3UA	†						Adder	1.91	4.52	3.70	310
BDBMCS2F1	BDBMCS2F1FS	BDBMCS2F1FSKIT	2	6	#14 - 2/0	#14 - #2	1	2.09	4.52	3.70	350
BDBMCS2F2	BDBMCS2F2FS						2	3.90	4.52	3.70	350
BDBMCS2F3	BDBMCS2F3FS						3	5.72	4.52	3.70	350
BDBMCS2FA	†						Adder	1.91	4.52	3.70	350
BDBMCS2N1	BDBMCS2N1FS	BDBMCS2N1FSKIT	2	2	#14 - 2/0	#14 - 2/0	1	2.09	4.52	3.70	350
BDBMCS2N2	BDBMCS2N2FS						2	3.90	4.52	3.70	350
BDBMCS2N3	BDBMCS2N3FS						3	5.72	4.52	3.70	350
BDBMCS2NA	†						Adder	1.91	4.52	3.70	350
BDBMCS5F1	BDBMCS5F1FS	BDBMCS5F1FSKIT	1	6	#4 - 500	#14 - #2	1	2.09	4.52	3.70	380
BDBMCS5F2	BDBMCS5F2FS						2	3.90	4.52	3.70	380
BDBMCS5F3	BDBMCS5F3FS						3	5.72	4.52	3.70	380
BDBMCS5FA	†						Adder	1.91	4.52	3.70	380
BDBMCS5M1	BDBMCS5M1FS	BDBMCS5M1FSKIT	1	4	#4 - 500	#14 - 2/0	1	2.09	4.52	3.70	380
BDBMCS5M2	BDBMCS5M2FS						2	3.90	4.52	3.70	380
BDBMCS5M3	BDBMCS5M3FS						3	5.72	4.52	3.70	380
BDBMCS5MA	†						Adder	1.91	4.52	3.70	380

Large Series:											
Open Style	Finger-Safe Style	Finger-Safe Kit	Run	Tap	Run	Tap	# of Poles	W	D	H	Amp Rating
BDBLCS3A1	BDBLCS3A1FS	BDBLCS3A1FSKIT	1	12	#6 - 350	#14 - #4	1	3.25	5.54	4.12	310
BDBLCS3A2	BDBLCS3A2FS						2	6.17	5.54	4.12	310
BDBLCS3A3	BDBLCS3A3FS						3	9.09	5.54	4.12	310
BDBLCS3AA	†						Adder	3.05	5.54	4.12	310
BDBLCS3K1	BDBLCS3K1FS	BDBLCS3K1FSKIT	1	6	#6 - 350	#14 - 2/0	1	3.25	5.54	4.12	310
BDBLCS3K2	BDBLCS3K2FS						2	6.17	5.54	4.12	310
BDBLCS3K3	BDBLCS3K3FS						3	9.09	5.54	4.12	310
BDBLCS3KA	†						Adder	3.05	5.54	4.12	310

VERSIPOLE™ (Continued)

Large Series: (continued)											
Catalog Number			# of Conductors		Wire Range (Class B, C, H, I, K, DLO)		# of Poles	Dimensions			Amp Rating per Pole
Open Style (Fig. 1)	Finger-Safe Style (Fig. 2)	Finger-Safe Kit (Fig. 3)	Run	Tap	Run	Tap		W	D	H	
BDBLCS5K1	BDBLCS5K1FS	BDBLCS5K1FSKIT	1	6	#4 - 500	#14 - 2/0	1	3.25	5.54	4.12	380
BDBLCS5K2	BDBLCS5K2FS						2	6.17	5.54	4.12	380
BDBLCS5K3	BDBLCS5K3FS						3	9.09	5.54	4.12	380
BDBLCS5KA	†						Adder	3.05	5.54	4.12	380
BDBLCS5W1	BDBLCS5W1FS	BDBLCS5W1FSKIT	1	1	#4 - 500	#4 - 500	1	3.25	5.54	4.12	380
BDBLCS5W2	BDBLCS5W2FS						2	6.17	5.54	4.12	380
BDBLCS5W3	BDBLCS5W3FS						3	9.09	5.54	4.12	380
BDBLCS5WA	†						Adder	3.05	5.54	4.12	380
BDBLCS4K1	BDBLCS4K1FS	BDBLCS4K1FSKIT	2	6	#6 - 350	#14 - 2/0	1	3.25	5.54	4.12	620
BDBLCS4K2	BDBLCS4K2FS						2	6.17	5.54	4.12	620
BDBLCS4K3	BDBLCS4K3FS						3	9.09	5.54	4.12	620
BDBLCS4KA	†						Adder	3.05	5.54	4.12	620
BDBLCS4T1	BDBLCS4T1FS	BDBLCS4T1FSKIT	2	2	#6 - 350	#6 - 350	1	3.25	5.54	4.12	620
BDBLCS4T2	BDBLCS4T2FS						2	6.17	5.54	4.12	620
BDBLCS4T3	BDBLCS4T3FS						3	9.09	5.54	4.12	620
BDBLCS4TA	†						Adder	3.05	5.54	4.12	620
BDBLCS6A1	BDBLCS6A1FS	BDBLCS6A1FSKIT	2	12	#4 - 500	#14 - #4	1	3.25	5.54	4.12	760
BDBLCS6A2	BDBLCS6A2FS						2	6.17	5.54	4.12	760
BDBLCS6A3	BDBLCS6A3FS						3	9.09	5.54	4.12	760
BDBLCS6AA	†						Adder	3.05	5.54	4.12	760
BDBLCS6K1	BDBLCS6K1FS	BDBLCS6K1FSKIT	2	6	#4 - 500	#14 - 2/0	1	3.25	5.54	4.12	760
BDBLCS6K2	BDBLCS6K2FS						2	6.17	5.54	4.12	760
BDBLCS6K3	BDBLCS6K3FS						3	9.09	5.54	4.12	760
BDBLCS6KA	†						Adder	3.05	5.54	4.12	760
BDBLCS6R1	BDBLCS6R1FS	BDBLCS6R1FSKIT	2	4	#4 - 500	#6 - 4/0	1	3.25	5.54	4.12	760
BDBLCS6R2	BDBLCS6R2FS						2	6.17	5.54	4.12	760
BDBLCS6R3	BDBLCS6R3FS						3	9.09	5.54	4.12	760
BDBLCS6RA	†						Adder	3.05	5.54	4.12	760
BDBLCS6V1	BDBLCS6V1FS	BDBLCS6V1FSKIT	2	2	#4 - 500	#4 - 500	1	3.25	5.54	4.12	760
BDBLCS6V2	BDBLCS6V2FS						2	6.17	5.54	4.12	760
BDBLCS6V3	BDBLCS6V3FS						3	9.09	5.54	4.12	760
BDBLCS6VA	†						Adder	3.05	5.54	4.12	760
BDBLCS8Y1	BDBLCS8Y1FS	—	2	2	#4 - 600 (Class B & C only)	#4 - 600 (Class B & C only)	1	3.25	5.54	4.12	840
BDBLCS8Y2	BDBLCS8Y2FS						2	6.17	5.54	4.12	840
BDBLCS8Y3	BDBLCS8Y3FS						3	9.09	5.54	4.12	840
BDBLCS8YA	—						Adder	3.05	5.54	4.12	840

† To achieve Finger-Safe style Adder order Open style Adder and Finger-Safe Kit

VERSIPOLE™

Double-Wide, Box-to-Stud, and Stud-to-Stud Styles

These styles offer additional splicing and tapping options over the standard Open and Finger-Safe styles.



Double-Wide
BDBLCS7X1DW shown

Features & Benefits

- 600 Volt Rated
- Listed to UL1953
- Rated for use with code and flex conductor without requiring ferrules
- AL9CU dual rated for use with copper and aluminum conductors
- Range taking conductor ports can accommodate wire sizes up to 535 DLO and can support up to 5 run conductors and up to 24 tap conductors
- High Short-Circuit Current Rating up to 100kA with proper fusing

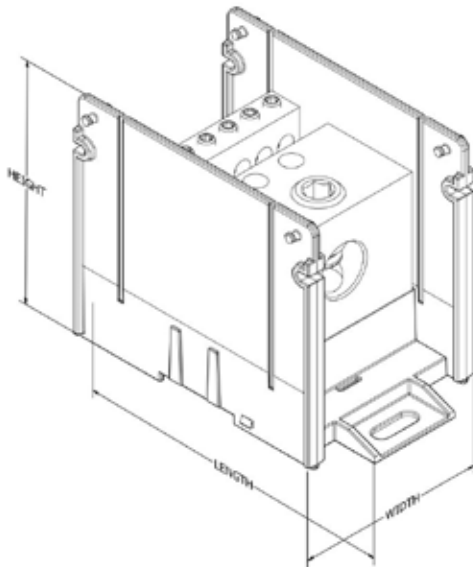

Box-to-Stud
BDBLCS5SK1 shown



Stud-to-Stud
BDBLCS5S5S1 shown

VERSIPOLE™ (Continued)



Double-Wide
BDBLCS7X1DW shown

Double-Wide Series:

Catalog Number	# of Conductors		Wire Range (Class B, C, H, I, K, DLO)		# of Poles	Dimensions			Amp Rating per Pole	SCCR ¹
	Run	Tap	Run	Tap		W	D	H		
BDBLCS7X1DW	5	5	#4 - 500	#4 - 500	1	6.17	5.54	4.12	1720	100kA
BDBLCS7R1DW	5	8	#4 - 500	#6 - 4/0	1	6.17	5.54	4.12	1456	100kA
BDBLCS7K1DW	5	12	#4 - 500	#14 - 2/0	1	6.17	5.54	4.12	1170	100kA
BDBLCS7A1DW	5	24	#4 - 500	#14 - #4	1	6.17	5.54	4.12	1026	100kA

¹ Short-Circuit Current Rating with proper fusing



Box-to-Stud
BDBLCS5SK1 shown



Stud-to-Stud
BDBLCS5S5S1 shown

Box-to-Stud and Stud-to-Stud Series:

Catalog Number	# of Conductors		Wire Range (Class B, C, H, I, K, DLO)		# of Poles	Dimensions			Amp Rating per Pole	SCCR ¹
	Run	Tap	Run	Tap		W	D	H		
BDBSCS1S1S1	1/4" Ø stud	1/4" Ø stud	—	—	1	1.34	2.76	5.56	175	100kA
BDBMCS3S3S1	3/8" Ø stud	3/8" Ø stud	—	—	1	2.09	4.52	3.70	350	100kA
BDBMCS3SM1	3/8" Ø stud	4	—	#14 - 2/0	1	2.09	4.52	3.70	350	100kA
BDBMCS3SF1	3/8" Ø stud	6	—	#14 - #2	1	2.09	4.52	3.70	350	100kA
BDBLCS5S5S1	1/2" Ø stud	1/2" Ø stud	—	—	1	3.25	5.54	4.12	620	100kA
BDBLCS5SK1	1/2" Ø stud	6	—	#14 - 2/0	1	3.25	5.54	4.12	380	100kA
BDBLCS5SA1	1/2" Ø stud	12	—	#14 - #4	1	3.25	5.54	4.12	310	100kA

¹ Short-Circuit Current Rating with proper fusing

VERSIPOLE™

Double-Wide Lay-In Style

These blocks feature a Lay-In channel that allows for continuous Run conductors, perfect for multi-level and/or multi-unit applications.



Features & Benefits

- 600 Volt Rated; Listed to UL1953
- Allows for continuous Run conductors
- Acceptable for panel mounting or DIN Rail mounting for medium and large sizes
- Rated for use with code and flex conductor without requiring ferrules
- AL9CU dual rated for use with copper and aluminum conductors
- Multiple configurations feature range taking conductor ports that accommodate wire sizes up to 1000 kcmil run and up to 12 tap conductors max. 500 kcmil
- High Short-Circuit Current Rating up to 100kA with proper fusing
- Supplied with Black Cover



Double-Wide Lay-In
BDBLCS13LK1DW shown

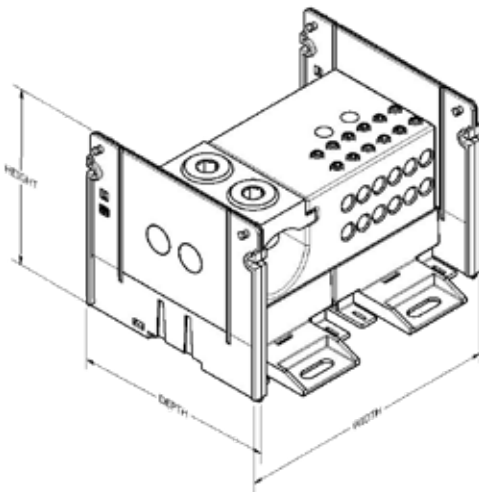

Double-Wide Lay-In Single Pole
BDBLCS13LA1DW shown

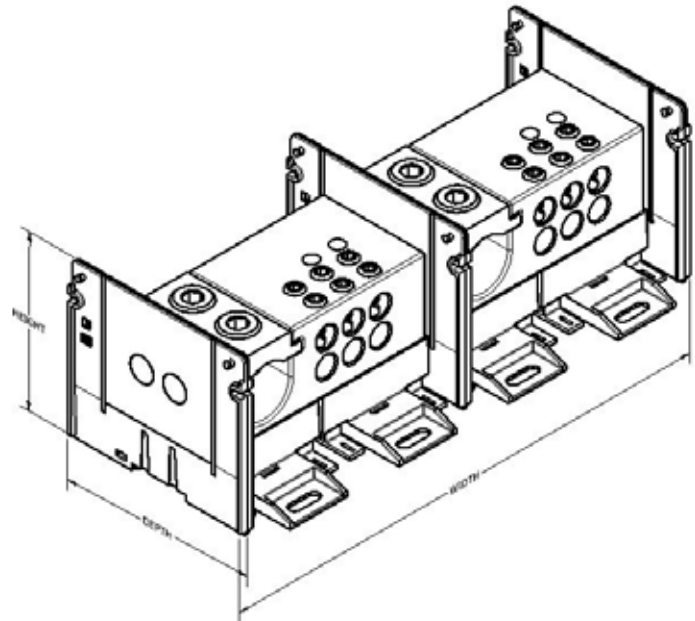

Double-Wide Lay-In Two Pole
BDBLCS13LK2DW shown

VERSIPOLE™ (Continued)



Double-Wide Lay-In
BDBLCS13LK1DW shown

Double-Wide Lay-In Series:

Catalog Number	# of Conductors		Wire Range (Class B, C, H, I, K, DLO)		# of Poles	Dimensions			Amp Rating per Pole	SCCR ¹
	Run	Tap	Run	Tap		W	D	H		
BDBLCS10LV1DW	1	2	500 - 750	#4 - 500	1	6.17	5.54	4.12	475	100kA
BDBLCS10LV2DW					2	12.00	5.54	4.12		
BDBLCS10LV3DW					3	17.84	5.54	4.12		
BDBLCS10LR1DW	1	4	500 - 750	#6 - 4/0	1	6.17	5.54	4.12	475	100kA
BDBLCS10LR2DW					2	12.00	5.54	4.12		
BDBLCS10LR3DW					3	17.84	5.54	4.12		
BDBLCS10LK1DW	1	6	500 - 750	#14 - 2/0	1	6.17	5.54	4.12	475	100kA
BDBLCS10LK2DW					2	12.00	5.54	4.12		
BDBLCS10LK3DW					3	17.84	5.54	4.12		
BDBLCS10LA1DW	1	12	500 - 750	#14 - #4	1	6.17	5.54	4.12	475	100kA
BDBLCS10LA2DW					2	12.00	5.54	4.12		
BDBLCS10LA3DW					3	17.84	5.54	4.12		
BDBLCS13LV1DW	1	2	750 - 1000	#4 - 500	1	6.17	5.54	4.12	545	100kA
BDBLCS13LV2DW					2	12.00	5.54	4.12		
BDBLCS13LV3DW					3	17.84	5.54	4.12		
BDBLCS13LR1DW	1	4	750 - 1000	#6 - 4/0	1	6.17	5.54	4.12	545	100kA
BDBLCS13LR2DW					2	12.00	5.54	4.12		
BDBLCS13LR3DW					3	17.84	5.54	4.12		
BDBLCS13LK1DW	1	6	750 - 1000	#14 - 2/0	1	6.17	5.54	4.12	545	100kA
BDBLCS13LK2DW					2	12.00	5.54	4.12		
BDBLCS13LK3DW					3	17.84	5.54	4.12		
BDBLCS13LA1DW	1	12	750 - 1000	#14 - #4	1	6.17	5.54	4.12	545	100kA
BDBLCS13LA2DW					2	12.00	5.54	4.12		
BDBLCS13LA3DW					3	17.84	5.54	4.12		

¹ Short-Circuit Current Rating with proper fusing

This Page Intentionally Left Blank

Table of Contents

General Information	B-2	Nylon Insulated		Quick Disconnects, Male, Female		Insulated Ferrules for Copper	
Military Specification Equivalents		Type TN-LF	B-37	Uninsulated, Bare		(Series D, T, & W), Type YF-I-L.....	B-74
SAE AS25036 / SAE AS20659.....	B-4	Shrouded, Type YAE-N-LF	B-38	Male, Type Q-M.....	B-61	Insulated Twin Ferrules For Copper	
Ring Tongue		Heat Shrink Insulated		Female, Type Q-F	B-61	(Series D), Type YFTW-IDL.....	B-77
Bare, Uninsulated		Type YHSA-K-LF	B-39	Vinyl Insulated		Small Terminal Kits	B-78
Types T / YAD	B-5	Block Fork Tongue		Male, Type QP-M.....	B-62	Nylon Insulated Pigtail Splice	
Type YAD	B-6	Bare, Uninsulated, Shrouded		Female, Type QP-F	B-62	Types YQE / RK.....	B-81
Heavy Duty, Type YAV	B-20	Types YAV-H-F / YAV-Z	B-44	Nylon Insulated			
#8-4/0 Str. Copper, Type YAV-L.....	B-21	Polyvinylchloride Insulated		Male, Type QN-M.....	B-63		
Shrouded, Type YAV-H.....	B-23	Type TP-BF	B-40	Female, Type QN-F	B-63		
Polyvinylchloride Insulated		Nylon Insulated		Heat Shrink Insulated			
Types TP / BA	B-8	Type TN-BF.....	B-41	Male, Type YHSQ-M.....	B-65		
Nylon Insulated		Shrouded, Type YAE-N-BF.....	B-42	Female, Type YHSQ-F	B-66		
Types TN / YAES.....	B-9	Heat Shrink Insulated		Vinyl Fully Insulated			
Multi-Finger, Type YAE-G.....	B-10	Type YHSA-K-BF.....	B-43	Female, Type FQP-F	B-64		
Multi-Finger, Type YAE-N	B-11	Flanged Fork Tongue		Nylon Fully Insulated			
Types YAEV / YAEV-L	B-24	Polyvinylchloride Insulated		Male, Type FQN-M.....	B-64		
Heat Shrink Insulated		Types TP-Z / BA-EZ.....	B-45	Female, Type FQN-F	B-65		
Type YHSA.....	B-12	Nylon Insulated		Heat Shrink Fully Insulated			
Radiation Resistant Insulated		Multi-Finger, Type YAE-Z.....	B-46	Female, Type YHSFQ-F	B-66		
Type YAES-K	B-13	Butt Splice		Quick Disconnects, Male/Female Combo			
Nickel Plated, SAE AS20659		Bare, Uninsulated		Uninsulated, Bare			
Green Banded Ring, Type YAV	B-15	Rolled, Type YSV-B	B-47	Type PG	B-67		
Right Angle Ring Tongue		Seamless, Type YSV.....	B-48	Vinyl Insulated			
Bare, Types YAV-R / YAV-RS	B-26	#8-4/0 Copper, Type YSV-L.....	B-49	Type PGP	B-68		
Nylon Insulated, for larger diameters		Cable Strain Relief, Type YSV-H... B-50		Nylon Insulated			
Type YAEV-RS.....	B-27	Reducing, Types YSV / YRV-L.....	B-60	Type PGN.....	B-68		
Flag Type Ring Tongue		Polyvinylchloride Insulated		Heat Shrink Insulated			
Bare, Type YBM	B-28	Type SP	B-51	Type PGHS.....	B-67		
Fork Tongue		Nylon Insulated		Flag-Style Female Quick Disconnects			
Bare, Uninsulated		Type SN	B-52	Bare, Uninsulated			
Types T-F / YAD-F	B-29	Type SN-B.....	B-53	Type FL.....	B-69		
Type YAV-T-F	B-30	Aircraft and Commercial Flex Cables		Nylon Insulated			
Polyvinylchloride Insulated		Type YSE	B-54	Type FLN	B-69		
Types TP-F / BA-EF	B-31	Heat Shrink Insulated		OIKTAP™ Splices			
Nylon Insulated		Type YSE-HHS.....	B-55	Type YAIT	B-70		
Types TN-F / YAES-F	B-32	Type YHSS.....	B-56	OIKTAP™ Tap Connectors			
Multi-Finger, Type YAE-N-F	B-33	Radiation Resistant Insulated		Type TTV.....	B-70		
Heat Shrink Insulated		Type YSES-K.....	B-57	Pin Terminals, Vinyl Insulated			
Type YHSA-F.....	B-34	Parallel Splice		Type PTV.....	B-71		
Locking Fork Tongue		Bare, Uninsulated		Uninsulated Ferrules for Copper			
Bare, Uninsulated		Type YSM	B-58	Type YF-UIL.....	B-72		
Type T-LF.....	B-35	Color-Coded Uninsulated					
Polyvinylchloride Insulated		Type YSCM.....	B-59				
Types TP-LF / BA-EL	B-36						

Most frequently ordered catalog numbers are highlighted in BLUE

Performance

The terminals and splices in this catalog are approved, per SAE-AS7928 and/or UL486, where indicated. Table 1 shows the performance requirements for terminals used in military and commercial equipment. The voltage drops listed are maximum allowable values taken at currents well above rated current for the wires. Tensile values assure that the wires will not become separated from the terminals under reasonably expected stresses. UL tensile values are chosen to reflect the severest expected duty. MIL Specification tensile values apply only to crimp terminations and reflect minimum values that are obtained in good crimp joints. Actual performance of BURNDY terminals exceeds the requirements of Table 1. Typical values are shown in Figures 1-5. For High Temperature applications BURNDY® YAV series with nickel plating “-NK” suffix provide for continuous operation to 650° F and 750° F intermittent service.

Table 1

Performance Requirements — Terminals for Copper Wire					
Wire Size	Per SAE-AS7928			Per UL 486	
	Test Current (Amps)	Max. Voltage Drop (Mv.)	Min. Tensile Strength (lbs)	Min. Tensile Strength (lbs)	Test Current For Max. 50°C Rise (Amps)
26	3	8	7	—	—
24	4.5	8	10	—	—
22	9	7	15	8	—
20	11	6	19	13	—
19	16	5	38	20	—
18	22	7	50	30	—
14	32	6	70	50	15
12	41	5	110	70	20
13	55	5	150	80	30
8	73	5	225	90	50
6	101	5	300	100	65
4	135	5	400	140	85
2	181	5	550	180	115
1	211	5	650	200	130
1/0	245	5	700	250	150
2/0	283	5	750	300	175
3/0	320	5	825	350	200
4/0	380	5	875	450	230

Fig. 1. Tensile strength of YAD HYLUG™ after axial rotation stresses.

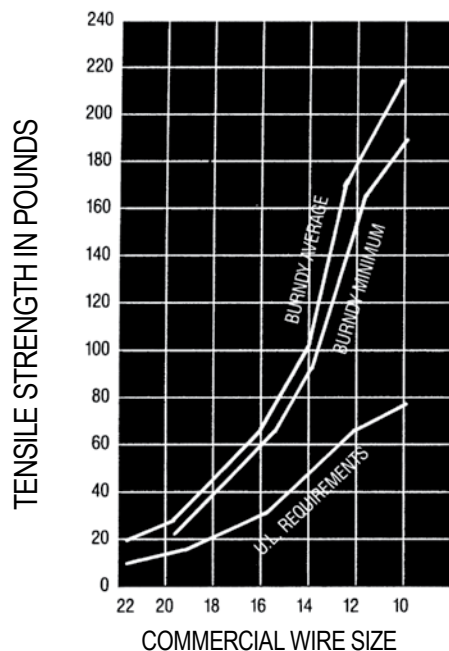

Fig. 2. Tensile strength of BA VINYLUG™ after axial rotation stresses.

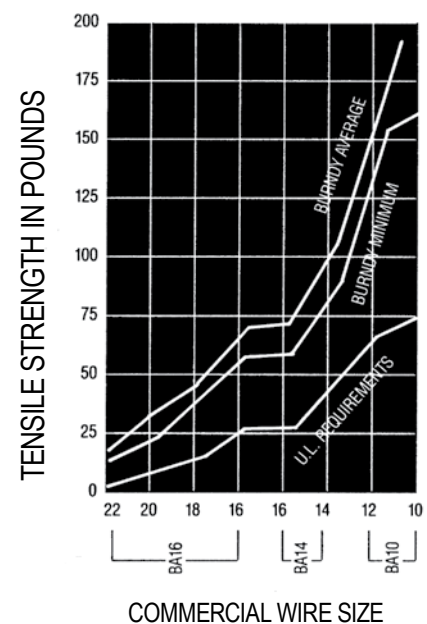

Fig. 3. Tensile strength of YAES INSULUG™ after vibration.

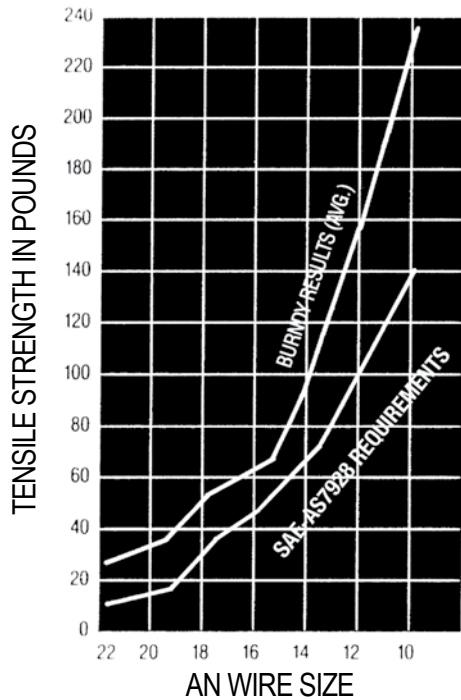

Fig. 5. Voltage drops of YAES at currents per Table 1 after vibration.

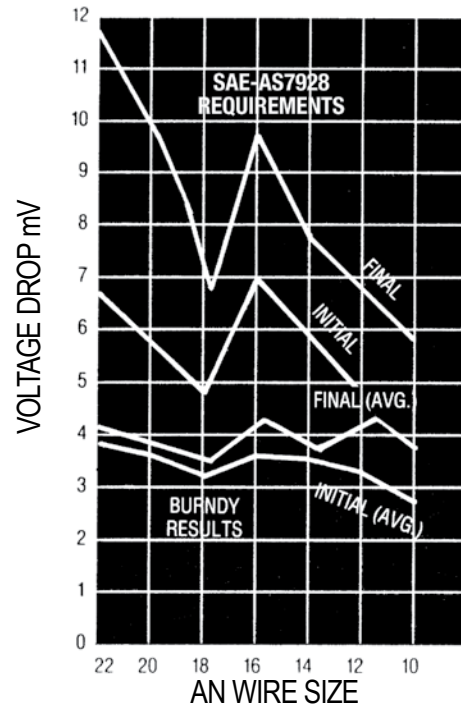
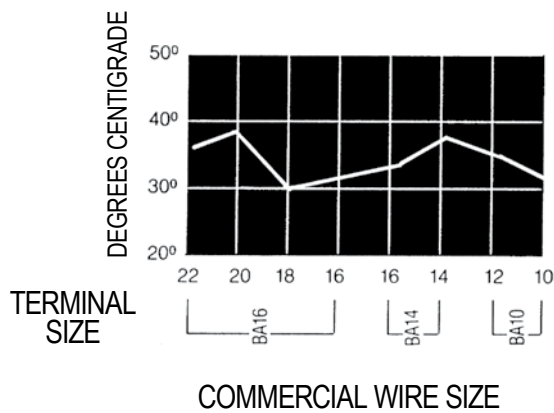

Fig. 4. Temperature rise of BA VINYLUG™ at currents per Table 1.



EQUIVALENT TABLES

MILITARY SPECIFICATIONS

Terminals

BURNDY® Equivalents to SAE-AS25036 in accordance with Specification SAE-AS7928.

Terminals

BURNDY® Equivalents to SAE-AS20659 in accordance with Specification SAE-AS7928.

AS25036 Dash No.	Catalog Number	Class 1	Class 2	AS25036 Dash No.	Catalog Number	Class 1	Class 2	AS20659 Dash No.	Catalog Number	Class 1	Class 2	AS20659 Dash No.	Catalog Number	Class 1	Class 2
101	YAES18N1	X	X	124	YAEV4CL4	X	X	105	YAV10	X	X	134	YAV1CL3	X	X
	YAE18G43		X	125	YAEV4CL2	X	X	106	YAV10T2	X	X	135	YAV25L3	X	X
102	YAES18N2	X	X	126	YAEV2CL1	X	X	107	YAV8CL	X	X	136	YAV26L3	X	X
	YAE18N21		X	127	YAEV2CL	X	X	108	YAV8CL2	X	X	137	YAV28L54	X	X
103	YAES18N3	X	X	128	YAEV2CL4	X	X	109	YAV6CL	X	X	140	YAV8CL14	X	X
	YAE18N		X	129	YAEV1CL1	X	X	110	YAV6CL2	X	X	141	YAV8CL1	X	X
104	YAES18N4	X	X	130	YAEV1CL	X	X	111	YAV4CL	X	X	142	YAV8CL4	X	X
	YAE18N3		X	131	YAEV1CL3	X	X	112	YAV4CL2	X	X	143	YAV6CL10	X	X
105	YAES18N5	X	X	132	YAEV25L1	X	X	113	YAV2CL1	X	X	144	YAV4CL3	X	X
				133	YAEV25L	X	X	114	YAV2CL	X	X	145	YAV4CL5	X	X
106	YAES14N6	X	X	134	YAEV25L3	X	X	115	YAV1CL1	X	X	146	YAV2CL3	X	X
	YAE14N43		X	135	YAEV26L2	X	X	116	YAV1CL	X	X	147	YAV2CL2	X	X
107	YAES14N7	X	X	136	YAEV26L	X	X	117	YAV25L1	X	X	148	YAV2CL11	X	X
	YAE14N43		X												
108	YAES14N8	X	X	137	YAEV26L3	X	X	118	YAV25L	X	X	149	YAV1CL2	X	X
	YAE14N		X	143	YAE22G18		X	119	YAV26L2	X	X	150	YAV1CL4	X	X
109	YAES14N9	X	X	144	YAE22G16		X	120	YAV26L	X	X	151	YAV25L2	X	X
	YAE14N3		X	145	YAE22G13		X	121	YAV27L	X	X	152	YAV25L16	X	X
110	YAES14N10	X	X	146	YAE22G14		X	122	YAV27L1	X	X	153	YAV26L1	X	X
	YAE14N4		X	147	YAE22G15		X	123	YAV28L	X	X	154	YAV26L16	X	X
111	YAES10N11	X	X	148	YAES18N48	X	X	124	YAV28L12	X	X	155	YAV27L20	X	X
	YAE10N5		X		YAE18N17		X	128	YAV10T4	X	X	156	YAV27L18	X	X
112	YAES10N12	X	X	149	YAES18N49	X	X	129	YAV8CL3	X	X	157	YAV28L56	X	X
	YAE10N		X		YAE18N1		X	130	YAV6CL1	X	X	158	YAV28L60	X	X
113	YAES10N13	X	X	150	YAES18N50	X	X	131	YAV6CL4	X	X	159	YAV28L13	X	X
	YAE10N2		X		YAE18N		X	132	YAV4CL4	X	X	160	YAV28L14	X	X
114	YAES10N14	X	X	152	YAES14N52	X	X	133	YAV2CL4	X	X	165	YAV10T7	X	X
	YAE10N4		X	153	YAES14N53	X	X								
115	YAEV8CL	X	X	154	YAE14N1		X	<p>Main Office Cage Code Number: 1NJK8</p> <p>Notes: For factory cage code numbers, please contact your local BURNDY® sales representative or the Headquarters at the phone number shown below.</p> <p>SAE stands for the Society of Automotive Engineering, which has replaced the Military Specifications.</p>							
116	YAEV8CL1	X	X		YAES14N54	X	X								
117	YAEV8CL2	X	X	YAE14N2		X									
118	YAEV8CL3	X	X	YAES14N55	X	X									
119	YAEV6CL1M	X	X	YAES10N56	X	X									
120	YAEV6CLM	X	X	YAE10N11		X									
121	YAEV6CL4M	X	X	YAES1-N57	X	X									
122	YAEV6CL2M	X	X	YAE10N3		X									
123	YAEV4CL	X	X	158	YAES10N58	X	X								

Main Office Cage Code Number: 1NJK8

Notes:

For factory cage code numbers, please contact your local BURNDY® sales representative or the Headquarters at the phone number shown below.

SAE stands for the Society of Automotive Engineering, which has replaced the Military Specifications.

TYPES T AND YAD

HYLUG™

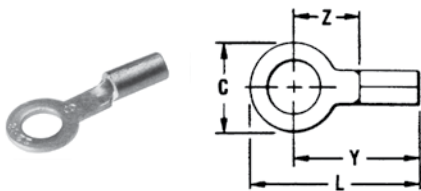
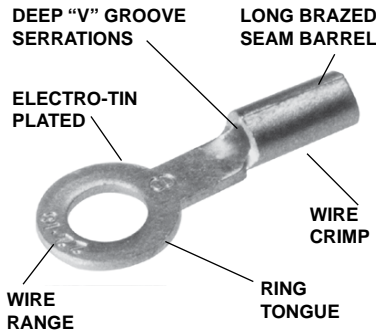

The Type T uninsulated terminals are constructed of pure electrolytic copper. Designed with a long brazed seam barrel, standard neck, deep V groove inner serrations and electro-tin plated. The terminals are ideal for control wiring and other standard duty applications.

The ring tongue provides a secure termination under the screw head that cannot be removed without the complete removal of the screw. Two or more terminals can easily be stacked on a common stud.

Features & Benefits

- Constructed of pure electrolytic copper for maximum conductivity, low resistance and ductility for excellent crimp forming properties
- Long brazed seam barrel and deep V groove inner serrations provide optimum conductivity reliability and holding power after crimping
- Electro-tin plating to provide durable, long-lasting corrosion resistance
- Wire range is clearly marked on terminal for easy identification
- Inspection hole for an easy visual check of wire insertion
- Long neck terminal permits easy bending and stacking of several terminals on a common stud

NOTE: Field bending straight lugs to achieve an angular connection will void UL Listing / CSA Certifications and BURNDY will not be liable for the connection.

Catalog Number	Wire Range AWG, AN, Aircraft	Stud Size	Dimensions				Bulk Catalog Number	Installation Tooling	Tape Mounted Catalog Number 2000/Reel	Tape Fed Installation Tooling	Wire Strip Length
			C	L Max.	Y Max.	Z Min.					
T184	22 AWG-18 AWG	#3 - #4	0.25	0.65	0.53	0.24	YAD184	Non-Ratchet: Y10D, Y1022 Ratchet: MRE1022B, MR8G98, Y8MRB1, MR20	YAD184M	OEM175TFM Tool with TFM2214B Die	9/32"
T186		#4 - #6	0.25	0.65	0.53	0.24	YAD186		YAD186M		
T188		#6 - #8	0.31	0.77	0.61	0.33	YAD188		YAD188M		
T1810		#8 - #10	0.31	0.77	0.61	0.33	YAD1810		YAD1810M		
T1814		1/4	0.45	0.96	0.73	0.44	YAD1814		YAD1814M		
T18516		5/16	0.45	0.96	0.73	0.44	YAD18516		—		
T1838		3/8	0.53	1.05	0.78	0.49	YAD1838		—		
T144	20 AWG-14 AWG	#3 - #4	0.25	0.67	0.55	0.26	YAD144	Non-Ratchet: Y10D, Y1022 Ratchet: MRE1022B, MR8G98, Y8MRB1, MR20	—	OEM175TFM Tool with TFM2214B Die	9/32"
T146		#4 - #6	0.25	0.67	0.55	0.26	YAD146		YAD146M		
T148		#6 - #8	0.31	0.77	0.61	0.33	YAD148		YAD148M		
T1410		#8 - #10	0.31	0.77	0.61	0.33	YAD1410		YAD1410M		
T1414		1/4	0.45	0.96	0.73	0.44	YAD1414		YAD1414M		
T14516		5/16	0.45	0.96	0.73	0.44	YAD14516		—		
T1438		3/8	0.53	1.05	0.78	0.49	YAD1438		YAD1438M		
T106	12 AWG-10 AWG	#4 - #6	0.37	0.83	0.64	0.29	YAD106	Non-Ratchet: Y10D, Y1022 Ratchet: MRE1022B, MR8G98, Y8MRB1, MR20	—	OEM175TFM Tool with TFM1210B Die	11/32"
T108		#6 - #8	0.37	0.83	0.64	0.29	YAD108		YAD108M		
T1010		#8 - #10	0.38	0.83	0.64	0.29	YAD1010		—		
T1014		1/4	0.46	0.97	0.74	0.39	YAD1014		YAD1014M		
T1016		5/16	0.53	1.02	0.76	0.41	YAD10516		YAD10516M		
T1038		3/8	0.58	1.08	0.79	0.44	YAD1038		YAD1038M		
T1012*		1/2	0.69	1.21	0.86	0.61	—		—		

* Not UL Listed or CSA Certified.

TYPE YAD

HYLUG™

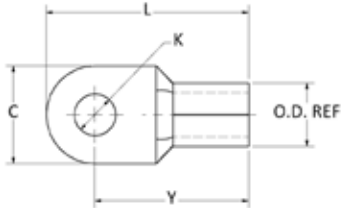

The YAD un-insulated OEM lug terminal is constructed of electrolytic copper. Designed with a brazed seam barrel, standard neck, V-groove inner serrations and electro-tin plated. The round ring tongue provides a secure termination under the screw head that cannot be removed without the complete removal of the screw. Two or more terminals can easily be stacked on a common stud. These terminals are ideal for use with code or flex cable.

Features & Benefits

- Terminals utilize a brazed seam
- Provide excellent high conductivity connections
- Electro-tin plated for durable long lasting corrosion resistance
- Vibration resistance and tensile strength is well within the limits of commercial specifications

NOTE: Field bending straight lugs to achieve an angular connection will void UL Listing / CSA Certifications and BURNDY will not be liable for the connection.

Catalog Number	Wire Range Copper Code & Flex [mm]	Stud Size	C	K Dia.	L	OD	T	Y	Installation Tooling				Wire Strip Length	
									Mechanical Tooling	Hydraulic Tooling (requires nest & indenter)				Dieless Tooling (no dies required)
										Tool	Die Nest	Indenter		
YAD8CM4E8	8 AWG [6-10]	#8	0.40	0.17	0.83	0.26	0.04	0.63	Y1MRTC Y8MRB1 Red Groove	35 and 750 Series	UV8L UM8CN	Y34PL UMA	3/8"	
YAD8CM5E10		#10	0.40	0.21	0.83	0.26	0.04	0.63						
YAD8CM6E14		1/4	0.43	0.26	0.89	0.26	0.04	0.67						
YAD8CM8E516		5/16	0.55	0.33	1.06	0.26	0.04	0.79						
YAD8CM10E38		3/8	0.71	0.41	1.18	0.26	0.04	0.83						
YAD8CM12E12		1/2	0.87	0.51	1.34	0.26	0.04	0.91						
YAD8CM16E58		5/8	1.10	0.67	1.93	0.26	0.04	1.38						
YAD6CM5E10	6 AWG [10-16]	#10	0.43	0.21	1.00	0.32	0.05	0.79	Y1MRTC Blue Groove	35 and 750 Series	UV6L UM6CN	Y34PL UMB	7/16"	
YAD6CM6E14		1/4	0.43	0.26	1.00	0.32	0.05	0.79						
YAD6CM8E516		5/16	0.55	0.33	1.14	0.32	0.05	0.87						
YAD6CM10E38		3/8	0.71	0.41	1.30	0.32	0.05	0.95						
YAD6CM12E12		1/2	0.87	0.51	1.46	0.32	0.05	1.02						
YAD4CM5E10	4 AWG [16-25]	#10	0.47	0.21	1.22	0.41	0.06	0.98	—	35 and 750 Series	UV2L UM4CN	Y34PR UMB	1/2"	
YAD4CM6E14		1/4	0.47	0.26	1.22	0.41	0.06	0.98						
YAD4CM8E516		5/16	0.63	0.33	1.30	0.41	0.06	0.98						
YAD4CM10E38		3/8	0.71	0.41	1.38	0.41	0.06	1.02						
YAD4CM12E12		1/2	0.87	0.51	1.65	0.41	0.06	1.22						
YAD4CM16E58		5/8	1.10	0.67	1.93	0.41	0.06	1.38						
YAD2CM6E14	2 AWG [25-35]	1/4	0.59	0.26	1.32	0.48	0.06	1.02	—	35 and 750 Series	U1CD1 UM2CN	Y34PR UMB	17/32"	
YAD2CM8E516		5/16	0.63	0.33	1.34	0.48	0.06	1.02						
YAD2CM10E38		3/8	0.71	0.41	1.42	0.48	0.06	1.06						
YAD2CM12E12		1/2	0.87	0.51	1.65	0.48	0.06	1.22						
YAD2CM16E58		5/8	1.10	0.67	1.97	0.48	0.06	1.42						
YAD2CM20E34		3/4	1.10	0.80	1.97	0.48	0.06	1.42						
YAD1CM6E14	1 AWG [35-50]	1/4	0.71	0.26	1.69	0.57	0.07	1.34	—	35 and 750 Series	UV26L	Y34PA	3/4"	
YAD1CM8E516		5/16	0.71	0.33	1.69	0.57	0.07	1.34						
YAD1CM10E38		3/8	0.71	0.41	1.69	0.57	0.07	1.34						
YAD1CM12E12		1/2	0.87	0.51	1.85	0.57	0.07	1.42						
YAD1CM16E58		5/8	1.10	0.67	2.13	0.57	0.07	1.57						
YAD1CM20E34		3/4	1.10	0.80	2.13	0.57	0.07	1.57						
YAD25M6E14	1/0 AWG [35-50]	1/4	0.71	0.26	1.69	0.57	0.07	1.34	—	35 and 750 Series	UV26L UM25N	Y34PA UMC	3/4"	
YAD25M8E516		5/16	0.71	0.33	1.69	0.57	0.07	1.34						
YAD25M10E38		3/8	0.71	0.41	1.69	0.57	0.07	1.34						
YAD25M12E12		1/2	0.87	0.51	1.85	0.57	0.07	1.42						
YAD25M16E58		5/8	1.10	0.67	2.13	0.57	0.07	1.57						
YAD25M20E34		3/4	1.10	0.80	2.13	0.57	0.07	1.57						

TYPE YAD (Continued)



Catalog Number	Wire Range Copper Code & Flex [mm]	Stud Size	C	K Dia.	L	OD	T	Y	Installation Tooling			Wire Strip Length	
									Hydraulic Tooling (requires nest & indenter)				Dieless Tooling (no dies required)
									Tool	Die Nest	Indenter		
YAD26M6E14	2/0 AWG [50-70]	1/4	0.87	0.26	1.93	0.67	0.08	1.50	35 and 750 Series	U28D1 UM26N	Y34PR2 UMC	13/16"	
YAD26M8E516		5/16	0.87	0.33	1.93	0.67	0.08	1.50					
YAD26M10E38		3/8	0.87	0.41	1.93	0.67	0.08	1.50					
YAD26M12E12		1/2	0.87	0.51	1.93	0.67	0.08	1.50					
YAD26M16E58		5/8	1.10	0.67	2.20	0.67	0.08	1.65					
YAD26M20E34		3/4	1.10	0.80	2.20	0.67	0.08	1.65					
YAD27M8E516	3/0 AWG [70-95]	5/16	0.95	0.33	2.13	0.79	0.10	1.65	35 and 750 Series	U29D1 UM27N	Y34PR2 UMC	7/8"	
YAD27M10E38		3/8	0.95	0.41	2.13	0.79	0.10	1.65					
YAD27M12E12		1/2	0.95	0.51	2.13	0.79	0.10	1.65					
YAD27M16E58		5/8	1.10	0.67	2.28	0.79	0.10	1.73					
YAD27M20E34		3/4	1.10	0.80	2.28	0.79	0.10	1.73					
YAD28M6E14	4/0 AWG [95-120]	1/4	0.95	0.26	2.20	0.89	0.12	1.73	35 and 750 Series	U32D1 UM28N	Y34PR2 UMC	1"	
YAD28M8E516		5/16	0.95	0.33	2.20	0.89	0.12	1.73					
YAD28M10E38		3/8	0.95	0.41	2.20	0.89	0.12	1.73					
YAD28M12E12		1/2	0.95	0.51	2.20	0.89	0.12	1.73					
YAD28M16E58		5/8	1.10	0.67	2.44	0.89	0.12	1.89					
YAD28M20E34		3/4	1.10	0.80	2.44	0.89	0.12	1.89					
YAD30M10E38	250-300 kcmil [120-150]	3/8	1.18	0.41	2.56	1.00	0.13	1.97	46 Series 750 Series	P34D UM30N	P48PR2 UME	1-1/8"	
YAD30M12E12		1/2	1.18	0.51	2.56	1.00	0.13	1.97					
YAD30M16E58		5/8	1.18	0.67	2.56	1.00	0.13	1.97					
YAD30M20E34		3/4	1.18	0.80	2.56	1.00	0.13	1.97					
YAD31M10E38	300-350 kcmil [150-185]	3/8	1.42	0.41	2.68	1.12	0.14	1.97	46 Series 750 Series	P34D UM31N	P48PR2 UME	1-1/4"	
YAD31M12E12		1/2	1.42	0.51	2.68	1.12	0.14	1.97					
YAD31M16E58		5/8	1.42	0.67	2.68	1.12	0.14	1.97					
YAD31M20E34		3/4	1.42	0.80	2.68	1.12	0.14	1.97					
YAD33M10E38	400-450 kcmil [185-240]	3/8	1.50	0.41	2.95	1.24	0.16	2.20	46 Series 750 Series	P36D UM33N	P48PR2 UME	1-3/8"	
YAD33M12E12		1/2	1.50	0.51	2.95	1.24	0.16	2.20					
YAD33M16E58		5/8	1.50	0.67	2.95	1.24	0.16	2.20					
YAD33M20E34		3/4	1.50	0.80	2.95	1.24	0.16	2.20					
YAD36M10E38	500-600 kcmil [240-300]	3/8	1.97	0.41	3.70	1.44	0.18	2.72	46 Series 750 Series	P44D UM36N	P48PR2 UME	1-1/2"	
YAD36M12E12		1/2	1.97	0.51	3.70	1.44	0.18	2.72					
YAD36M16E58		5/8	1.97	0.67	3.70	1.44	0.18	2.72					
YAD36M20E34		3/4	1.97	0.80	3.70	1.44	0.18	2.72					

Small Terminals

Polyvinylchloride Insulated Compression
Ring Tongue Terminal

TYPES TP AND BA

600 Volts Max., 105° C Max.

VINYLUG™

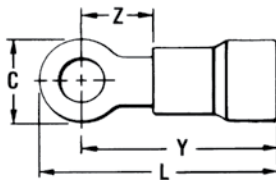

VINYLUG™ Type TP is designed for commercial and light duty industrial control and power circuit applications. Supplied with an expanded polyvinyl chloride (PVC) insulation shroud, many tongue variations and rated 600V makes TP terminals versatile and economical.

Features & Benefits

- Expanded insulation support accepts standard and large wire diameters lowering inventory requirements and permitting greater flexibility along with insulation support
- Funnel entry for easy wire insertion
- Manufactured of pure electrolytic copper providing maximum conductivity, low resistance and ductility for excellent crimp forming properties
- Deep V groove serrations in the inner barrel for added holding strength
- Electro-tin plating for durable, long-lasting corrosion resistance

NOTE: Field bending straight lugs to achieve an angular connection will void UL Listing / CSA Certifications and BURNDY will not be liable for the connection.

Catalog Number	Wire Range (AWG/kcmil)	Stud Size	Dimensions				Bulk Catalog Number	Installation Tooling	Tape Mounted Catalog Number/Reel	Tape Fed Installation Tooling	Wire Strip Length
			C	L	Y	Z					
TP164	22-16 Max. Insul. Dia. Accom...145 Color Code: Red	#3-#4	0.22	0.71	0.61	0.17	BA16E4	Plier Type: Y1022, Y10D or Ratchet Tool: MR8891, MR8G96, MR15 MRE1022NV	BA16E4M	OEM175TFM with TFM2218NV Die	13/64"
TP166		#6	0.25	0.74	0.62	0.18	BA16E6		BA16E6M		
TP168		#6 - #8	0.31	0.85	0.70	0.26	BA16E8		BA16E8M		
TP1610		#8 - #10	0.31	0.85	0.70	0.26	BA16E10		BA16E10M		
TP1614		1/4	0.40	0.99	0.79	0.36	BA16E14		BA16E14M		
TP16516*		5/16	0.47	1.11	0.88	0.41	—		—		
TP1638		3/8	0.53	1.15	0.88	0.45	BA16E38		BA16E38M		
TP144	16-14 Max. Insul. Dia. Accom...180 Color Code: Blue	#4	0.22	0.11	0.61	0.17	BA14E4	Plier Type: Y1022, Y10D or Ratchet Tool: MR8891, MR8G96, MR15 MRE1022NV	BA14E4M	OEM175TFM with TFM1614NV Die	13/64"
TP146		#6	0.25	0.74	0.62	0.18	BA14E6		BA14E6M		
TP148		#6 - #8	0.31	0.85	0.70	0.26	BA14E8		BA14E8M		
TP1410		#8 - #10	0.31	0.85	0.70	0.26	BA14E10		BA14E10M		
TP1414		1/4	0.40	0.99	0.79	0.36	BA14E14		BA14E14M		
TP14516		5/16	0.53	1.15	0.88	0.45	BA14E516		BA14E516M		
TP1438		3/8	0.53	1.15	0.88	0.45	BA14E38		—		
TP106	12-10 Max. Insul. Dia. Accom...260 Color Code: Yellow	#6	0.31	0.68	0.75	0.20	BA10E6	Plier Type: Y1022, Y10D or Ratchet: MR8891, MR15, M8ND w/N10HET23 MRE1022NV	BA10E6M	OEM175TFM with TFM1210NV Die	19/64"
TP108		#6 - #8	0.36	1.00	0.81	0.26	BA10E8		BA10E8M		
TP1010		#8-#10	0.36	1.00	0.81	0.26	BA10E10		BA10E10M		
TP1014		1/4	0.53	1.22	0.95	0.40	BA10E14		BA10E14M		
TP10516		5/16	0.53	1.22	0.95	0.42	BA10E516		—		
TP1038		3/8	0.53	1.27	1.00	0.45	BA10E38		BA10E38M		
TP1012*		1/2	0.69	1.51	1.17	0.61	—		—		

* Not UL Listed or CSA Certified.

TYPES TN AND YAES

INSULUG™

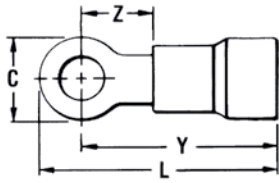

NOTE: Field bending straight lugs to achieve an angular connection will void UL Listing / CSA Certifications and BURNDY will not be liable for the connection.

600 Volts Max., 105° C Max

INSULUG™ type TN Nylon-insulated terminals are designed for heavy duty industrial, utility and military power and control-circuit applications for wire sizes 26 AWG through 10 AWG. They offer high dielectric strength and stability in oily conditions and meet military CLASS 1 and CLASS 2 requirements per SAE-AS25036 and the requirements of military specifications SAE-AS7928.

Features & Benefits

- Integral one-piece copper barrel / insulation grip and wire strain relief design for improved physical strength characteristics over a multi-piece design
- Manufactured of pure electrolytic copper for maximum conductivity, low resistance and ductility for excellent crimp forming properties
- Brazed seam provides a stronger barrel design, minimizes any possible splitting and eliminated folding
- Deep inner barrel serrations and smooth funnel entry for excellent conductivity and pullout strength values along with easy wire insertion
- Insulation is locked in place, will not twist off, maintaining proper dielectric values
- Electro-tin plated for durable, long lasting resistance to corrosion
- Color-coded and clearly marked for quick, easy wire size identification
- Ring tongue provides a secure termination under the screw head that cannot be removed without complete removal of the screw, allowing two or more terminals to be stacked on a common stud

Catalog Number	Wire Range (AWG/kcmil)	Stud Size	SAE-25036	Dimensions				Bulk Catalog Number	Installation Tooling	Wire Strip Length
				C	L Max.	Y Max.	Z Max.			
TN184	22-18 Max. Insul. Dia. Accom.: .120 Color Code: Red	#3 - #4	-148	0.23	0.76	0.64	0.20	YAES18N48	Ratchet: MR883♦ MRE1022NV Non-Ratchet: Y10D, Y1022	7/32
TN186		#4 - #6	-101	0.25	0.76	0.64	0.20	YAES18N1		
TN186G1*		#4 - #6	-102	0.25	0.87	0.74	0.49	YAES18N2		
TN188		#6 - #8	-149	0.31	0.91	0.76	0.29	YAES18N49		
TN1810		#8 - #10	-103	0.31	0.91	0.76	0.29	YAES18N3		
TN1814		#12-1/4	-150	0.46	1.09	0.87	0.41	YAES18N50		
TN18516		5/16	-104	0.46	1.09	0.87	0.41	YAES18N4		
TN1838		3/8	-105	0.53	1.17	0.91	0.45	YAES18N5		
TN144	16-14 Max. Insul. Dia. Accom.: .153 Color Code: Blue	#3 - #4	-152	0.25	0.79	0.67	0.24	YAES14N52	Ratchet: MR883♦ MRE1022NV Non-Ratchet: Y10D, Y1022	7/32
TN146		#4 - #6	-106	0.25	0.79	0.67	0.24	YAES14N6		
TN146G1*		#4 - #6	-107	0.30	0.91	0.76	0.51	YAES14N7		
TN148		#6 - #8	-153	0.31	0.89	0.74	0.31	YAES14N53		
TN1410		#8 - #10	-108	0.31	0.89	0.74	0.31	YAES14N8		
TN1414		#12-1/4	-154	0.45	1.08	0.86	0.43	YAES14N54		
TN14516		5/16	-109	0.45	1.08	0.86	0.43	YAES14N9		
TN1438		3/8	-110	0.53	1.16	0.90	0.47	YAES14N10		
TN106	12-10 Max. Insul. Dia. Accom.: .210 Color Code: Yellow	#4 - #6	-111	0.37	1.12	0.94	0.26	YAES10N11	Ratchet: MR883♦ MRE1022NV Non-Ratchet: Y10D, Y1022	11/32
TN108		#6 - #8	-156	0.37	1.12	0.94	0.26	YAES10N56		
TN1010		#8 - #10	-112	0.37	1.12	0.94	0.26	YAES10N12		
TN1014		#12-1/4	-157	0.53	1.32	1.06	0.37	YAES10N57		
TN10516		5/16	-113	0.53	1.32	1.06	0.37	YAES10N13		
TN1038		3/8	-114	0.58	1.34	1.05	0.40	YAES10N14		
TN1012*		1/2	-158	0.69	1.51	1.18	0.61	YAES10N58		

* Not UL Listed or CSA Certified.

♦QPL Class II when installed with MR833 ratchet tool.

TYPE YAE-G

INSULUG™



300 Volts Max., 105° C Max.

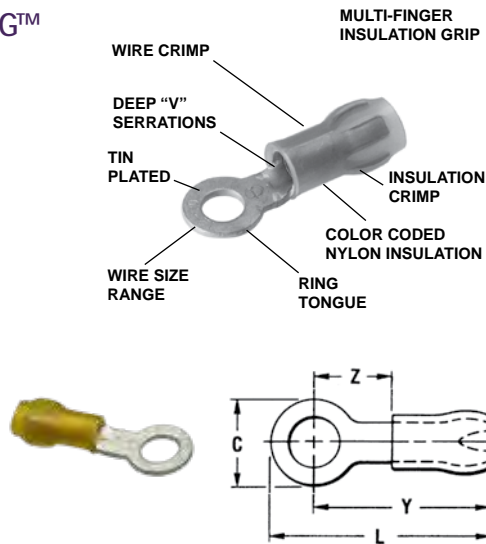

INSULUG™ Type YAE-G nylon insulated terminals are designed with a multi-finger insulation grip for paper, EPR and other elastic or hard to grip insulations. The metal fingers firmly grip the insulation providing superior holding characteristics, cable support and strain relief. Type YAE-G terminals are rated 105° C and meet military standard AS25036 Class 2 and SAE-AS7928 requirements.

Features & Benefits

- Multi-finger insulation grip for superior holding characteristics, especially on EPR and other elastic-type insulations
- Brazed seam for stronger, more durable termination
- Manufactured of pure electrolytic copper providing maximum conductivity, low resistance, and ductility for excellent crimp forming properties
- Deep V groove, inner barrel serrations for optimum conductivity, reliability, and holding power
- Smooth funnel entry provides easy wire insertion

NOTE: Field bending straight lugs to achieve an angular connection will void UL Listing / CSA Certifications and BURNDY will not be liable for the connection.

Catalog Number	Wire Range (AWG/kcmil)	Stud Size	** SAE-AS25036-	Dimensions				Bulk Catalog Number	Installation Tooling	Tape Mounted Catalog Number 2000/Reel	Tape Fed Installation Tooling †	Wire Strip Length
				C	L Max.	Y Max.	Z Max.					
YAE22G18BOX	26-20 Max. Insul. Dia. Accom.: .098 Color Code: Amber	#2	143	0.15	0.69	0.62	0.22	YAE22G18	M8ND♦ with N14HET25V1 Die MR81A	YAE22G18M	† OEM175TFM with TFM2218NV Die	5/32"
YAE22G12BOX		#1 - #2	—	0.25	0.74	0.62	0.22	YAE22G12		—		
YAE22G16BOX		#4	144	0.18	0.75	0.62	0.22	YAE22G16		YAE22G16M		
YAE22G13BOX		#4 - #6	145	0.25	0.74	0.62	0.22	YAE22G13		YAE22G13M		
YAE22G14BOX		#6 - #8	146	0.32	0.82	0.67	0.27	YAE22G14		—		
YAE22G15BOX		#8 - #10	147	0.32	0.83	0.67	0.27	YAE22G15		—		

* 1000/Box

** Class 2

† Only with #22-#20 AWG wire

♦QPL Class II when installed with M8ND tool with N14HET25V1 Die

TYPE YAE-N

INSULUG™

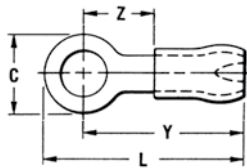
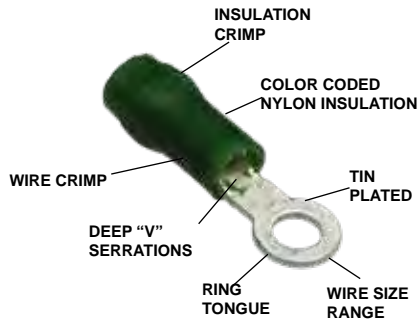

600 Volts Max., 105° C Max

INSULUG™ Type YAE-N nylon insulated terminals are designed with a multi-finger insulation grip for paper, EPR and other elastic or hard to grip insulations. The metal fingers firmly grip the insulation providing superior holding characteristics, cable support and strain relief. Type YAE-N terminals are rated 105° C and meet military standard AS25036 Class 2 and SAE-AS7928 requirements.

Features & Benefits

- Multi-finger insulation grip provides superior insulation holding characteristics, especially on EPR and other elastic-type insulations
- Brazed seam for a stronger, more durable termination
- Manufactured of pure electrolytic copper for maximum conductivity, low resistance and ductility for excellent crimp forming properties
- Deep V groove, inner barrel serrations for optimum conductivity, reliability, and holding power
- Smooth funnel entry for easy wire insertion

NOTE: Field bending straight lugs to achieve an angular connection will void UL Listing / CSA Certifications and BURNDY will not be liable for the connection.

Catalog Number	Wire Range	Stud Size	***SAE-AS25036	Dimensions				Bulk Catalog Number	Installation Tooling	Tape Mounted Catalog Number 2000/Reel	Tape Fed Installation Tooling	Wire Strip Length
				C	L Max.	Y Max.	Z Min.					
YAE18N26BOX	22 - 16	#4	—	0.22	0.78	0.70	0.19	YAE18N26	MR81A, MR833T1, MRE1022NV (no extra dies required) M8ND with one of the following dies: N14HET25V1, N10ET9, N14HET15, N10ET23♦ or Y10D, Y1022	YAE18N26M	OEM175TFM with TFM2218NV Die	3/16"
YAE18N21BOX		#4 #6	102	0.25	0.89	0.77	0.28	YAE18N21		YAE18N21M		
YAE18N1BOX		#8	149	0.31	0.92	0.79	0.28	YAE18N1		—		
YAE18N24BOX		#6 #8	—	0.28	0.90	0.77	0.28	YAE18N24		YAE18N24M		
YAE18NBOX		#8 #10	103 150	0.31	0.92	0.77	0.28	YAE18N		YAE18NM		
YAE18N2BOX		1/4	—	0.45	1.10	0.88	0.40	YAE18N2		YAE18N2M		
YAE18N3BOX		5/16	104	0.45	1.11	0.88	0.40	YAE18N3		YAE18N3M		
YAE18N15BOX		3/8	—	0.53	1.19	0.93	0.43	YAE18N15		YAE18N15M		
YAE14N43BOX	16 - 14	#4 #6	106 107	0.25	0.82	0.69	0.21	YAE14N43	MR81A, MR833T1, MRE1022NV (no extra dies required) M8ND with one of the following dies: N14HET25V1, N10ET9, N14HET15, N10ET23♦ or Y10D, Y1022	YAE14N43M	OEM175TFM with TFM1614NV Die	3/16"
YAE14N1BOX		#6 #8	153	0.31	0.92	0.75	0.28	YAE14N1	YAE14N1M			
YAE14NBOX		#8 #10	108	0.31	0.92	0.75	0.28	YAE14N	YAE14NM			
YAE14N2BOX		1/4	154	0.45	1.11	0.88	0.40	YAE14N2	YAE14N2M			
YAE14N3BOX		5/16	109	0.45	1.11	0.88	0.40	YAE14N3	YAE14N3M			
YAE14N4BOX		3/8	110	0.53	1.19	0.93	0.45	YAE14N4	YAE14N4M			
YAE12N9BOX	14 - 12	#6 #8	—	0.31	1.06	0.90	0.29	YAE12N9	MR81A, MR833T1, MRE1022NV (no extra dies required) Y10D M8ND with N12HET1	YAE12N9M	OEM175TFM with TFM1210NV Die	21/64"
YAE12N1BOX		#6 #8	—	0.31	1.06	0.90	0.29	YAE12N1	YAE12N1M			
YAE12N2BOX		1/4	—	0.45	1.25	1.02	0.40	YAE12N2	YAE12N2M			
YAE12N7BOX		#5	—	0.31	1.06	0.90	0.29	YAE12N7	YAE12N7M			
YAE12NBOX		#8 #10	—	0.31	1.06	0.90	0.29	YAE12N	YAE12NM			
YAE10N5BOX	12 - 10	#4 #6	111	0.38	1.15	0.96	0.28	YAE10N5	MR833T1, MRE1022NV (no extra dies required) M8ND with one of the following dies: N10HET15, N10ET9, N10ET23♦ Y10D Y1022	YAE10N5M	OEM175TFM with TFM1210NV Die	3/8"
YAE10N11BOX		#6 #8	156	0.38	1.17	0.98	0.30	YAE10N11		YAE10N11M		
YAE10NBOX		#8 #10	112	0.38	1.15	0.96	0.28	YAE10N		YAE10NM		
YAE10N3BOX		1/4	157	0.54	1.39	1.12	0.44	YAE10N3		YAE10N3M		
YAE10N2BOX		5/16	113	0.54	1.39	1.12	0.44	YAE10N2		YAE10N2M		
YAE10N4BOX		3/8	114	0.54	1.39	1.12	0.44	YAE10N4		YAE10N4M		
YAE10N79BOX*		1/2	—	0.72	1.50	1.20	0.58	—		—		

* Not UL Listed or CSA Certified.

♦QPL Class II when installed with M8ND tool with N10ET23 Die

TYPE YHSA

HYDENT™

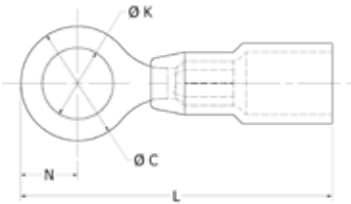

Copper Conductor; -55° through 110° C

Standard crimp terminals leave the wire exposed allowing in moisture or other contaminants which can result in corrosion. Corrosion reduces the amount of current the wire can carry safely. The integrity of the electrical system can be compromised when unsealed electrical connections are utilized. Heat shrink terminals provide a durable seal blocking out contaminants ensuring a better connection.

Features & Benefits

- Made from pure copper, annealed for maximum strength
- Color-coded, imprinted with wire size
- Serrated barrels offer maximum wire contact and tensile strength
- Electro-tin plated for corrosion resistance

NOTE: Field bending straight lugs to achieve an angular connection will void UL Listing / CSA Certifications and BURNDY will not be liable for the connection.

Catalog No. (100/bag)	Catalog No. (20/bag)	Stud Size	Conductor Size	Dimensions					Installation Tooling	Wire Strip Length
				C	K	L	N	Tongue Thickness		
YHSA18K6	YHSA18K6RK	4-6	22-18 AWG	0.29	0.14	1.18	0.14	0.03	MR22	5/16
YHSA18K8	YHSA18K8RK	6-8	22-18 AWG	0.32	0.17	1.18	0.17	0.03	MR22	5/16
YHSA18K10	YHSA18K10RK	8-10	22-18 AWG	0.32	0.20	1.18	0.33	0.03	MR22	5/16
YHSA18K14	YHSA18K14RK	1/4	22-18 AWG	0.47	0.27	1.40	0.38	0.03	MR22	5/16
YHSA18K516	YHSA18K516RK	5/16	22-18 AWG	0.47	0.33	1.40	0.23	0.04	MR22	5/16
YHSA18K38	YHSA18K38RK	3/8	22-18 AWG	0.56	0.40	1.45	0.28	0.03	MR22	5/16
YHSA14K6	—	4-6	16-14 AWG	0.30	0.14	1.18	0.15	0.04	MR22	5/16
YHSA14K8	YHSA14K8RK	6-8	16-14 AWG	0.32	0.17	1.18	0.16	0.03	MR22	5/16
YHSA14K10	YHSA14K10RK	8-10	16-14 AWG	0.32	0.20	1.18	0.17	0.03	MR22	5/16
YHSA14K14	YHSA14K14RK	1/4	16-14 AWG	0.47	0.26	1.40	0.23	0.03	MR22	5/16
YHSA14K516	—	5/16	16-14 AWG	0.47	0.33	1.35	0.23	0.04	MR22	5/16
YHSA14K38	YHSA14K38RK	3/8	16-14 AWG	0.56	0.40	1.45	0.28	0.03	MR22	5/16
YHSA10K6	—	4-6	12-10 AWG	0.34	0.14	1.15	0.17	0.04	MR22	5/16
YHSA10K8	—	6-8	12-10 AWG	0.34	0.17	1.15	0.17	0.04	MR22	5/16
YHSA10K10	YHSA10K10RK	8-10	12-10 AWG	0.34	0.20	1.15	0.18	0.04	MR22	5/16
YHSA10K14	YHSA10K14RK	1/4	12-10 AWG	0.56	0.26	1.45	0.15	0.04	MR22	5/16
YHSA10K516	—	5/16	12-10 AWG	0.56	0.34	1.45	0.28	0.04	MR22	5/16
YHSA10K38	YHSA10K38RK	3/8	12-10 AWG	0.56	0.40	1.45	0.28	0.04	MR22	5/16
YHSA10K12	YHSA10K12RK	1/2	12-10 AWG	0.69	0.53	1.69	0.36	0.04	MR22	5/16

TYPE YAES-K

INSULUG™

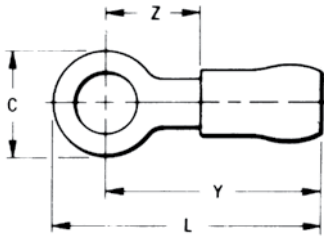
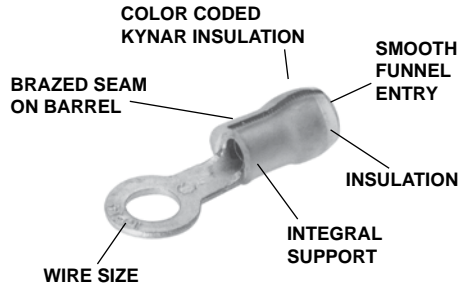

NOTE: Field bending straight lugs to achieve an angular connection will void UL Listing / CSA Certifications and BURNDY will not be liable for the connection.

KYNAR - is a registered trademark of the Penwalt Corp. for Polyvinylidene Fluoride (PVF₂)
HYPALON - Is a registered trademark of the E.I. DuPont deNemours & Co., Inc.

200 Megarads., -60° through 150°C, 600 Volts

Type YAES-K, radiation resistant insulated terminals are designed and have been tested to meet the requirements for class 1E critical circuits as set by the Nuclear Regulatory Commission (NRC). Additional testing for compatibility under loss of coolant accident (LOCA) conditions with cross-link polyethylene (XLP) and HYPALON® insulations was completed successfully. Compatibility with ethylene propylene rubber (EPR) insulation was determined by analysis. Each terminal is manufactured of pure electrolytic copper per QQ-C 576 and bright tin-plated per MIL-T-10727 and meets or exceeds MIL-T-7928 using stranded copper AWG wire. The KYNAR® insulation offers 200 megarad radiation resistance.

The Type YAES-K radiation resistant insulated terminals are suitable for class 1E critical circuits and non-critical nuclear associated applications.

Features & Benefits

- Insulation provides 200 megarad radiation resistance plus successfully tested for insulation compatibility
- An integral one-piece copper barrel/insulation grip and wire strain relief design provides improved physical strength characteristics over a multi-piece design
- The insulation is locked in place and will not move or twist off, thereby maintains proper dielectric values
- Manufactured from pure electrolytic copper to provide maximum conductivity, low resistance and ductility for excellent crimp forming properties.
- Bright tin-plated per MIL-T-10727 for durable long-lasting resistance to corrosion
- Deep inner barrel serrations provides excellent electrical conductivity and tensile strength values
- Brazed seam gives a stronger barrel design to minimize any possible splitting and eliminates folding
- Smooth funnel entry for easy wire insertion
- Color coded terminals provides easy wire size identification and inspection
- Coded raised dots in the die area of the connection after compression for visual identification that the correct tool and die were used for proper installation
- Inspection hole gives an additional visual check to ensure proper wire insertion
- Ring tongue design provides a secure termination under screw head that cannot be removed without the complete removal of the screw
- Multiple terminals may be stacked on a common stud easily providing flexibility and versatility

Small Terminals

Radiation Resistant Insulated
Compression Ring Terminals

TYPE YAES-K (Continued)



NOTE: Field bending straight lugs to achieve an angular connection will void UL Listing / CSA Certifications and BURNDY will not be liable for the connection.

Catalog Number	Stud Size	Conductor Size	Dimensions				Installation Tooling	Wire Strip Length
			C	L Max.	Y Max.	Z Max.		
YAES18K1	#6	22-18 AWG str. Max. Insul. Dia. Accom.: 0.12 Color Code: Red	0.23	0.76	0.64	0.20	Ratchet Tool: MR10G6 Crimp Mark: (1) Small Dot Red Groove Calibration Gauge: PG3731	7/32"
YAES18K2	#6		0.25	0.87	0.74	0.29		
YAES18K49	#8		0.32	0.91	0.76	0.29		
YAES18K3	#10		0.32	0.91	0.76	0.29		
YAES18K50	1/4		0.46	1.09	0.86	0.41		
YAES18K4	5/16		0.46	1.09	0.87	0.41		
YAES18K5	3/8		0.54	1.17	0.91	0.45		
YAES14K6	#6	16-14 AWG str. Max. Insul. Dia. Accom.: 0.15 Stock Thickness: 0.03 Color Code: Blue	0.26	0.77	0.65	0.22	Ratchet Tool: MR10G6 Crimp Mark: (2) Small Dots Blue Groove Calibration Gauge: PG3711	7/32"
YAES14K7	#6		0.32	0.91	0.76	0.29		
YAES14K53	#8		0.32	0.91	0.76	0.29		
YAES14K8	#10		0.32	0.91	0.76	0.29		
YAES14K54	1/4		0.46	1.09	0.86	0.41		
YAES14K9	5/16		0.46	1.09	0.86	0.41		
YAES14K10	3/8		0.53	1.18	0.91	0.45		
YAES10K11	#6	12-10 AWG str. Max. Insul. Dia. Accom.: 0.21 Stock Thickness: 0.04 Color Code: Yellow	0.38	1.12	0.94	0.26	Ratchet Tool: MR10G6 Crimp Mark: (1) Large Dot Calibration Gauge: PG3721	3/8"
YAES10K11T1	#6		0.31	1.09	0.94	0.26		
YAES10K56	#8		0.38	1.12	0.94	0.26		
YAES10K12	#10		0.38	1.12	0.94	0.26		
YAES10K57	1/4		0.54	1.32	1.06	0.37		
YAES10K13	5/16		0.54	1.32	1.06	0.37		
YAES10K14	3/8		0.58	1.34	1.05	0.40		
YAES10K58	1/2		0.72	1.41	1.06	0.45		

TYPE YAV

HYLUG™

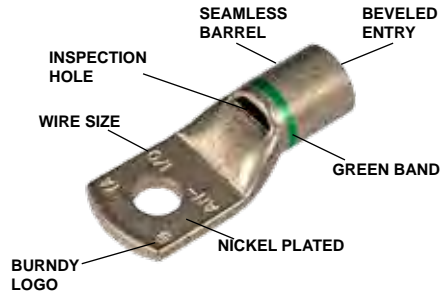

NOTE: Field bending straight lugs to achieve an angular connection will void UL Listing / CSA Certifications and BURNDY will not be liable for the connection.



HYLUG™ type YAV is a seamless, heavy duty uninsulated compression ring tongue terminal manufactured from pure electrolytic copper tubing and is for use on copper commercial (code) cable, type AN aircraft cable and extra flexible conductors. Because of its seamless design, the YAV HYLUG™ also accommodates solid conductors.

The seamless tubing produces a double thick tongue and a strong terminal for demanding applications that require high reliability. Applications include industrials, hospitals, electric utilities, aircraft, shipboard and marine, computers, steel mills, mining equipment and other equipment that is subject to vibration or requiring dependable electrical performance. The YAV HYLUG™ terminals meet the requirements of SAE-AS7928.

Features & Benefits

- Nickel plated for high temperature applications up to 650° F continuous service and 750° F intermittent service
- Provided with green band per AS20659 Revision F
- Manufactured from seamless pure electrolytic copper tubing to provide maximum conductivity, low resistance, and excellent ductility for crimping
- Double thick tongue provides a structurally strong terminal tongue
- Produced from tubular copper, extra copper material assures the compression terminal will operate cooler than the conductors it connects
- Internally beveled barrel for easy cable entry, especially for flexible conductors
- Inspection hole provides easy visual check for proper conductor insertion

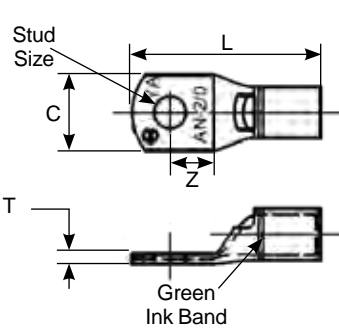

Figure 1
(straight)

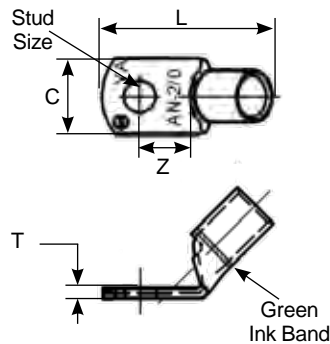

Figure 2
(45°)

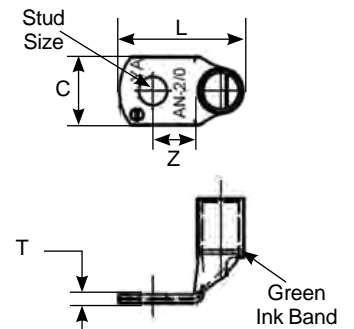
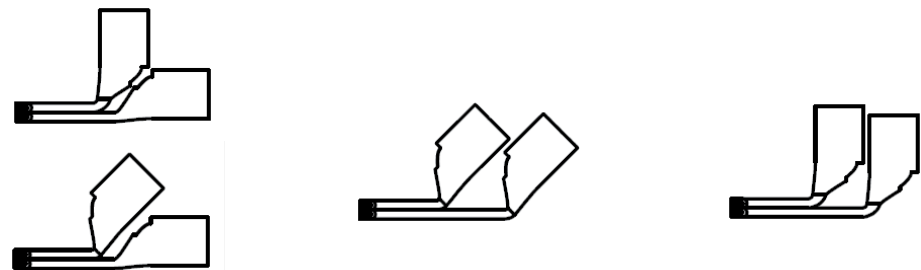

Figure 3
(90°)

Note:

Bottom Stack Options
(see Config "A", "B", or "C" bottom lug) may be available, please contact technical service.



Small Terminals

Nickel Plated, SAE AS20659 Green Banded
Compression Ring Tongue Terminals

TYPE YAV (Continued)

NOTE: Field bending straight lugs to achieve an angular connection will void UL Listing / CSA Certifications and BURNDY will not be liable for the connection.

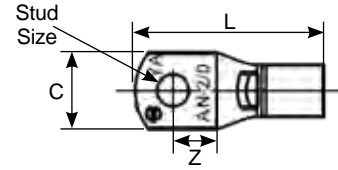

Catalog Number	SAE-AS20659	Copper Conductor		Fig. #	Stud Size	Dimensions				Installation Tooling (# crimps)					Wire Strip Length
		Code AWG	Aircraft Cable			C	L	T	Z	Die Index	Die Type	Y29 Series	35, 750 Series	Dieless Tools	
YAV10265	265	10-12	AN 12-10	1	#6	0.30	0.83	0.07	0.24	—	—	—	—	MR89Q (1)	7/16"
YAV1026545	—			2			0.94								
YAV1026590	—			3			0.58								
YAV10205	205	10-12	AN 12-10	1	#10	0.38	0.88	0.06	0.26	—	—	—	—	MR89Q (1)	7/16"
YAV1020545	—			2			0.96								
YAV1020590	—			3			0.62								
YAV10270	270	10-12	AN 12-10	1	1/4	0.47	1.06	0.05	0.34	—	—	—	—	MR89Q (1)	7/16"
YAV1027045	—			2			1.09								
YAV1027090	—			3			0.75								
YAV10206	206	10-12	AN 12-10	1	5/16	0.53	1.03	0.04	0.31	—	—	—	—	MR89Q (1)	7/16"
YAV1020645	—			2			1.06								
YAV1020690	—			3			0.75								
YAV10228	228	10-12	AN 12-10	1	3/8	0.56	1.08	0.04	0.37	—	—	—	—	MR89Q (1)	7/16"
YAV1022845	—			2			1.13								
YAV1022890	—			3			0.82								
YAV10266	266	10-12	AN 12-10	1	1/2	0.72	1.66	0.04	0.38	—	—	—	—	MR89Q (1)	7/16"
YAV1026645	—			2			1.22								
YAV1026690	—			3			0.91								
YAV8CL240	240	8	AN 8	1	#8	0.41	1.09	0.08	0.28	38	Nest Indentor	DV8L1 UV8L	Y29PL Y34PL	MY28, MY2911 (1)	1/2"
YAV8CL24045	—			2			1.12								
YAV8CL24090	—			3			0.68								
YAV8CL207	207	8	AN 8	1	#10	0.41	1.09	0.08	0.28	38	Nest Indentor	DV8L1 UV8L	Y29PL Y34PL	MY28, MY2911 (1)	1/2"
YAV8CL20745	—			2			1.15								
YAV8CL20790	—			3			0.71								
YAV8CL241	241	8	AN 8	1	1/4	0.46	1.16	0.07	0.33	38	Nest Indentor	DV8L1 UV8L	Y29PL Y34PL	MY28, MY2911 (1)	1/2"
YAV8CL24145	—			2			1.17								
YAV8CL24190	—			3			0.77								
YAV8CL208	208	8	AN 8	1	5/16	0.57	1.24	0.06	0.35	38	Nest Indentor	DV8L1 UV8L	Y29PL Y34PL	MY28, MY2911 (1)	1/2"
YAV8CL20845	—			2			1.25								
YAV8CL20890	—			3			0.84								
YAV8CL229	229	8	AN 8	1	3/8	0.57	1.24	0.06	0.35	38	Nest Indentor	DV8L1 UV8L	Y29PL Y34PL	MY28, MY2911 (1)	1/2"
YAV8CL22945	—			2			1.25								
YAV8CL22990	—			3			0.84								
YAV8CL242	242	8	AN 8	1	1/2	0.73	1.46	0.04	0.48	38	Nest Indentor	DV8L1 UV8L	Y29PL Y34PL	MY28, MY2911 (1)	1/2"
YAV8CL24245	—			2			1.44								
YAV8CL24290	—			3			1.06								
YAV6CL230	230	6	AN 6	1	#10	0.48	1.25	0.08	0.29	39	Nest Indentor	DV6L Y29PL	UV6L Y34PLA	MY28, MY2911 (1)	1/2"
YAV6CL23045	—			2			1.27								
YAV6CL23090	—			3			0.77								
YAV6CL209	209	6	AN 6	1	1/4	0.48	1.25	0.08	0.29	39	Nest Indentor	DV6L Y29PL	UV6L Y34PLA	MY28, MY2911 (1)	1/2"
YAV6CL20945	—			2			1.27								
YAV6CL20990	—			3			0.77								
YA6CL231	231	6	AN 6	1	5/16	0.49	1.37	0.06	0.36	39	Nest Indentor	DV6L Y29PL	UV6L Y34PLA	MY28, MY2911 (1)	1/2"
YAV6CL23145	—			2			1.35								
YAV6CL23190	—			3			0.89								

TYPE YAV (Continued)

NOTE: Field bending straight lugs to achieve an angular connection will void UL Listing / CSA Certifications and BURNDY will not be liable for the connection.

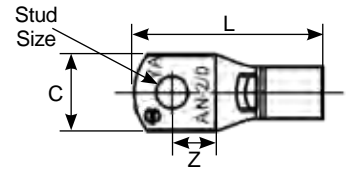

Catalog Number	SAE-AS20659	Copper Conductor		Fig. #	Stud Size	Dimensions				Installation Tooling (# crimps)					Wire Strip Length
		Code AWG	Aircraft Cable			C	L	T	Z	Die Index	Die Type	Y29 Series	35, 750 Series	Dieless Tools	
YAV6CL210	210	6	AN 6	1	3/8	0.60	1.37	0.06	0.36	39	Nest Indentor	DV6L Y29PL	UV6L Y34PLA	MY28, MY2911 (1)	1/2"
YAV6CL21045	—			2			1.35								
YAV6CL21090	—			3			0.89								
YAV6CL243	243	6	AN 6	1	1/2	0.74	1.58	0.05	0.49	39	Nest Indentor	DV6L Y29PL	UV6L Y34PLA	MY28, MY2911 (1)	1/2"
YAV6CL24345	—			2			1.54								
YAV6CL24390	—			3			1.09								
YAV4CL244	244	4	AN 4	1	#10	0.55	1.31	0.08	0.28	40	Nest Indentor	DV4L Y29PL	UV4L Y34PLA	MY28, MY2911 (1)	1/2"
YAV4CL24445	—			2			1.30								
YAV4CL24490	—			3			0.80								
YAV4CL211	211	4	AN 4	1	1/4	0.55	1.31	0.08	0.28	40	Nest Indentor	DV4L Y29PL	UV4L Y34PLA	MY28, MY2911 (1)	1/2"
YAV4CL21145	—			2			1.30								
YAV4CL21190	—			3			0.80								
YAV4CL232	232	4	AN 4	1	5/16	0.63	1.42	0.08	0.34	40	Nest Indentor	DV4L Y29PL	UV4L Y34PLA	MY28, MY2911 (1)	1/2"
YAV4CL23245	—			2			1.42								
YAV4CL23290	—			3			0.92								
YAV4CL212	212	4	AN 4	1	3/8	0.63	1.42	0.08	0.34	40	Nest Indentor	DV4L Y29PL	UV4L Y34PLA	MY28, MY2911 (1)	1/2"
YAV4CL21245	—			2			1.42								
YAV4CL21290	—			3			0.92								
YAV4CL245	245	4	AN 4	1	1/2	0.73	1.62	0.06	0.47	40	Nest Indentor	DV4L Y29PL	UV4L Y34PLA	MY28, MY2911 (1)	1/2"
YAV4CL24545	—			2			1.59								
YAV4CL24590	—			3			1.11								
YAV2CL246	246	2	AN 2	1	#10	0.60	1.66	0.10	0.35	41	Nest Indentor	DV2L Y29PL	UV2L Y34PLA	MY28, MY2911 (1)	5/8"
YAV2CL24645	—			2			1.66								
YAV2CL24690	—			3			1.02								
YAV2CL213	213	2	AN 2	1	1/4	0.60	1.66	0.10	0.35	41	Nest Indentor	DV2L Y29PL	UV2L Y34PLA	MY28, MY2911 (1)	5/8"
YAV2CL21345	—			2			1.66								
YAV2CL21390	—			3			1.02								
YAV2CL247	247	2	AN 2	1	5/16	0.60	1.66	0.10	0.35	41	Nest Indentor	DV2L Y29PL	UV2L Y34PLA	MY28, MY2911 (1)	5/8"
YAV2CL24745	—			2			1.66								
YAV2CL24790	—			3			1.02								
YAV2CL214	214	2	AN 2	1	3/8	0.60	1.66	0.10	0.35	41	Nest Indentor	DV2L Y29PL	UV2L Y34PLA	MY28, MY2911 (1)	5/8"
YAV2CL21445	—			2			1.66								
YAV2CL21490	—			3			1.02								
YAV2CL248	248	2	AN 2	1	7/16	0.60	1.82	0.09	0.47	41	Nest Indentor	DV2L Y29PL	UV2L Y34PLA	MY28, MY2911 (1)	5/8"
YAV2CL24845	—			2			1.80								
YAV2CL24890	—			3			1.17								
YAV2CL233	233	2	AN 2	1	1/2	0.60	1.82	0.09	0.47	41	Nest Indentor	DV2L Y29PL	UV2L Y34PLA	MY28, MY2911 (1)	5/8"
YAV2CL23345	—			2			1.80								
YAV2CL23390	—			3			1.17								
YAV1CL215	215	1	AN 1	1	1/4	0.76	1.78	0.12	0.38	41	Nest Indentor	DV1L Y29PL	UV1L Y34PLA	MY28, MY2911 (1)	5/8"
YAV1CL21545	—			2			1.80								
YAV1CL21590	—			3			1.12								
YAV1CL249	249	1	AN 1	1	5/16	0.76	1.78	0.12	0.38	41	Nest Indentor	DV1L Y29PL	UV1L Y34PLA	MY28, MY2911 (1)	5/8"
YAV1CL24945	—			2			1.80								
YAV1CL24590	—			3			1.12								

Small Terminals

Nickel Plated, SAE AS20659 Green Banded
Compression Ring Tongue Terminals

TYPE YAV (Continued)

NOTE: Field bending straight lugs to achieve an angular connection will void UL Listing / CSA Certifications and BURNDY will not be liable for the connection.

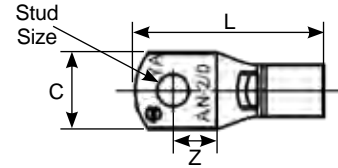

Catalog Number	SAE-AS20659	Copper Conductor		Fig. #	Stud Size	Dimensions				Installation Tooling (# crimps)					Wire Strip Length
		Code AWG	Aircraft Cable			C	L	T	Z	Die Index	Die Type	Y29 Series	35, 750 Series	Dieless Tools	
YAV1CL216	216	1	AN 1	1	3/8	0.76	1.78	0.12	0.38	41	Nest Indentor	DV1L Y29PL	UV1L Y34PLA	MY28, MY2911 (1)	5/8"
YAV1CL21645	—			2			1.80								
YAV1CL21690	—			3			1.12								
YAV1CL250	250	1	AN 1	1	7/16	0.86	1.91	0.11	0.47	41	Nest Indentor	DV1L Y29PL	UV1L Y34PLA	MY28, MY2911 (1)	5/8"
YAV1CL25045	—			2			1.92								
YAV1CL25090	—			3			1.26								
YAV1CL234	234	1	AN 1	1	1/2	0.84	1.91	0.11	0.47	41	Nest Indentor	DV1L Y29PL	UV1L Y34PLA	MY28, MY2911 (1)	5/8"
YAV1CL23445	—			2			1.92								
YAV1CL23490	—			3			1.26								
YAV25L217	217	1/0	AN 1/0	1	1/4	0.83	1.97	0.12	0.43	43	Nest Indentor	DV25L Y29PR	UV25L Y34PA	MY28, MY2911 (1)	11/16"
YAV25L21745	—			2			1.97								
YAV25L21790	—			3			1.23								
YAV25L251	251	1/0	AN 1/0	1	5/16	0.83	1.97	0.12	0.43	43	Nest Indentor	DV25L Y29PR	UV25L Y34PA	MY28, MY2911 (1)	11/16"
YAV25L25145	—			2			1.97								
YAV25L25190	—			3			1.23								
YAV25L218	218	1/0	AN 1/0	1	3/8	0.83	1.97	0.12	0.43	43	Nest Indentor	DV25L Y29PR	UV25L Y34PA	MY28, MY2911 (1)	11/16"
YAV25L21845	—			2			1.97								
YAV25L21890	—			3			1.23								
YAV25L252	252	1/0	AN 1/0	1	7/16	0.88	2.03	0.11	0.47	43	Nest Indentor	DV25L Y29PR	UV25L Y34PA	MY28, MY2911 (1)	11/16"
YAV25L25245	—			2			2.01								
YAV25L25290	—			3			1.29								
YAV25L235	235	1/0	AN 1/0	1	1/2	0.88	2.03	0.11	0.47	43	Nest Indentor	DV25L Y29PR	UV25L Y34PA	MY28, MY2911 (1)	11/16"
YAV25L23545	—			2			2.01								
YAV25L23590	—			3			1.29								
YAV26L253	253	2/0	AN 2/0	1	1/4	0.93	2.26	0.13	0.49	44	Nest Indentor	DV26L Y29PR	UV26L Y34PA	MY28, MY2911 (1)	13/16"
YAV26L25345	—			2			2.22								
YAV26L25390	—			3			1.38								
YAV26L219	219	2/0	AN 2/0	1	5/16	0.93	2.26	0.13	0.49	44	Nest Indentor	DV26L Y29PR	UV26L Y34PA	MY28, MY2911 (1)	13/16"
YAV26L21945	—			2			2.22								
YAV26L21990	—			3			1.38								
YAV26L220	220	2/0	AN 2/0	1	3/8	0.93	2.26	0.13	0.49	44	Nest Indentor	DV26L Y29PR	UV26L Y34PA	MY28, MY2911 (1)	13/16"
YAV26L22045	—			2			2.22								
YAV26L22090	—			3			1.38								
YAV26L254	254	2/0	AN 2/0	1	7/16	0.93	2.26	0.13	0.49	44	Nest Indentor	DV26L Y29PR	UV26L Y34PA	MY28, MY2911 (1)	13/16"
YAV26L25445	—			2			2.22								
YAV26L25490	—			3			1.38								
YAV26L236	236	2/0	AN 2/0	1	1/2	0.93	2.26	0.13	0.49	44	Nest Indentor	DV26L Y29PR	UV26L Y34PA	MY28, MY2911 (1)	13/16"
YAV26L23645	—			2			2.22								
YAV26L23690	—			3			1.38								
YAV27L255	255	3/0	AN 3/0	1	5/16	1.03	2.39	0.14	0.53	45	Nest Indentor	DV27L Y29PR	UV27L Y34PA	MY28, MY2911 (1)	13/16"
YAV27L25545	—			2			2.37								
YAV27L25590	—			3			1.50								
YAV27L221	221	3/0	AN 3/0	1	3/8	1.03	2.39	0.14	0.53	45	Nest Indentor	DV27L Y29PR	UV27L Y34PA	MY28, MY2911 (1)	13/16"
YAV27L22145	—			2			2.37								
YAV27L22190	—			3			1.50								

TYPE YAV (Continued)

NOTE: Field bending straight lugs to achieve an angular connection will void UL Listing / CSA Certifications and BURNDY will not be liable for the connection.

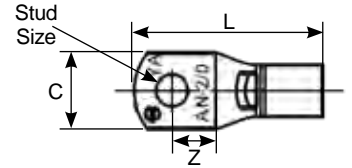

Catalog Number	SAE-AS20659	Copper Conductor		Fig. #	Stud Size	Dimensions				Installation Tooling (# crimps)					Wire Strip Length
		Code AWG	Aircraft Cable			C	L	T	Z	Die Index	Die Type	Y29 Series	35, 750 Series	Dieless Tools	
YAV27L256	256	3/0	AN 3/0	1	7/16	1.03	2.39	0.14	0.53	45	Nest Indentor	DV27L Y29PR	UV27L Y34PA	MY28, MY2911 (1)	13/16"
YAV27L25645	—			2			2.37								
YAV27L25690	—			3			1.50								
YAV27L222	222	3/0	AN 3/0	1	1/2	1.03	2.39	0.14	0.53	45	Nest Indentor	DV27L Y29PR	UV27L Y34PA	MY28, MY2911 (1)	7/8"
YAV27L22245	—			2			2.37								
YAV27L22290	—			3			1.50								
YAV28L257	257	4/0	AN 4/0	1	5/16	1.12	2.66	0.15	0.61	46	Nest Indentor	DV28L Y29PR	UV28L Y34PA	MY28, MY2911 (1)	7/8"
YAV28L25745	—			2			2.61								
YAV28L25790	—			3			1.67								
YAV28L223	223	4/0	AN 4/0	1	3/8	1.12	2.66	0.15	0.61	46	Nest Indentor	DV28L Y29PR	UV28L Y34PA	MY28, MY2911 (1)	7/8"
YAV28L22345	—			2			2.61								
YAV28L22390	—			3			1.67								
YAV28L258	258	4/0	AN 4/0	1	7/16	1.12	2.66	0.15	0.61	46	Nest Indentor	DV28L Y29PR	UV28L Y34PA	MY28, MY2911 (1)	7/8"
YAV28L25845	—			2			2.61								
YAV28L25890	—			3			1.67								
YAV28L224	224	4/0	AN 4/0	1	1/2	1.12	2.66	0.15	0.61	46	Nest Indentor	DV28L Y29PR	UV28L Y34PA	MY28, MY2911 (1)	7/8"
YAV28L22445	—			2			2.61								
YAV28L22490	—			3			1.67								
YAV28L259	259	4/0	AN 4/0	1	5/8	1.12	2.66	0.15	0.61	46	Nest Indentor	DV28L Y29PR	UV28L Y34PA	MY28, MY2911 (1)	7/8"
YAV28L25945	—			2			2.61								
YAV28L25990	—			3			1.67								
YAV28L260	260	4/0	AN 4/0	1	3/4	1.23	2.89	0.14	0.78	46	Nest Indentor	DV28L Y29PR	UV28L Y34PA	MY28, MY2911 (1)	7/8"
YAV28L26045	—			2			2.84								
YAV28L26090	—			3			1.90								
YAV28L237	237	4/0	AN 4/0	1	7/8	1.23	2.89	0.14	0.78	46	Nest Indentor	DV28L Y29PR	UV28L Y34PA	MY28, MY2911 (1)	7/8"
YAV28L23745	—			2			2.84								
YAV28L23790	—			3			1.90								

Note:

Bottom Stack Options (see Config "A", "B", or "C" bottom lug) may be available, please contact technical service.

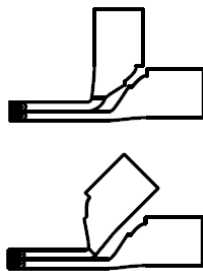

Config A
(top: 90/straight)
(bottom: 45/straight)

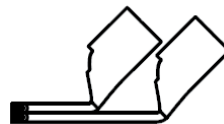

Config B
(45/45)



Config C
(90/90)

TYPES YAV / YAV-BOX

HYLUG™

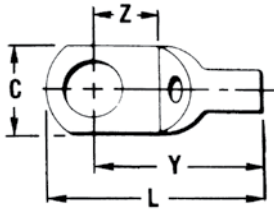
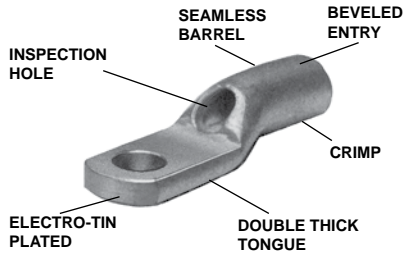

NOTE: Field bending straight lugs to achieve an angular connection will void UL Listing / CSA Certifications and BURNDY will not be liable for the connection.

HYLUG™ type YAV is a seamless, heavy duty uninsulated compression ring tongue terminal manufactured from pure electrolytic copper tubing and is for use on copper commercial (code) cable, type AN aircraft cable and extra flexible conductors. Because of its seamless design, the YAV HYLUG™ also accommodates solid conductors.

The seamless tubing produces a double thick tongue and a strong connector for demanding applications that require high reliability. Applications include industrials, hospitals, electric utilities, aircraft, shipboard and marine, computers, steel mills, mining equipment and other equipment that is subject to vibration or requiring dependable electrical performance. The YAV HYLUG™ terminals meet the requirements of SAE-AS7928.

Features & Benefits

- Manufactured from seamless pure electrolytic copper tubing to provide maximum conductivity, low resistance and excellent ductility for crimping
- Seamless tubular crimp barrel design — No seams to split resulting in a very high quality electrical connection, also can be used on solid conductor
- Double thick tongue structurally a very strong terminal tongue
- Produced from tubular copper, extra copper material assures the compression connector will operate cooler than the conductors it connects
- Internally beveled barrel for easy cable entry, especially for flexible conductors
- Inspection hole provides easy visual check for proper conductor insertion
- Electro-tin plated for a long lasting durable corrosion resistance

Catalog Number	Wire Range	Stud Size	SAE-AS25036	Dimensions				Bulk Catalog Number	Installation Tooling	Wire Strip Length
				C	L Max.	Y Max.	Z Min.			
YAV18T4BOX	22-18 Str. and Sol.	3,4	—	0.19	0.59	0.54	0.16	YAV18T4	Non-Ratchet: Y10D, Y1022 Ratchet: MR8G98, MR89Q, Y8MRB1, MR20, MRE1022B	9/32"
YAV18L33BOX		4-6	—	0.25	0.63	0.55	0.18	YAV18L33		
YAV18T5BOX		6-8	—	0.31	0.76	0.61	0.24	YAV18T5		
YAV18T1BOX		8-10	—	0.31	0.76	0.61	0.24	YAV18T1		
YAV18BOX		—	—	0.31	0.76	0.61	0.24	YAV18		
YAV14L33BOX	20-14 Str.	4-6	—	0.25	0.67	0.59	0.18	YAV14L33	Non-Ratchet: Y10D, Y1022 Ratchet: MR8G98, MR89Q, Y8MRB1, MR20, MRE1022B	9/32"
YAV14T5BOX		6-8	—	0.31	0.79	0.64	0.24	YAV14T5		
YAV14T1BOX		8-10	—	0.29	0.70	0.59	0.18	YAV14L36		
YAV14L36BOX	20-12 Sol.	8-10	—	0.29	0.79	0.64	0.24	YAV14	Non-Ratchet: Y10D, Y1022 Ratchet: MR8G98, MR89Q, Y8MRB1, MR20, MRE1022B	9/32"
YAV14BOX		1/4	—	0.40	0.99	0.75	0.32	YAV14T2		
YAV14T2BOX		5/16	—	0.44	0.99	0.75	0.32	YAV14T3		
YAV14T3BOX		8-10	—	0.30	0.78	0.67	0.24	YAV12G2		
YAV12G2BOX ■	† 14-12 Str.	8-10	—	0.30	0.78	0.67	0.24	YAV12G2	Y10D, Y8MRB1, M8ND w/N14HT	9/32"
YAV12G3BOX ■		1/4	—	0.34	1.00	0.76	0.33	YAV12G3		
YAV10T7BOX	14 Str. 12-10 Str. and Sol.	4-6	165	0.28	0.93	0.78	0.24	YAV10T7*	Non-Ratchet: Y10D, Y1022 Ratchet: MR8G98, MR89Q, Y8MRB1, MR20, N10HT, N10HT24, MRE1022B	7/16"
YAV10T11BOX		6-8	—	0.38	0.93	0.79	0.26	YAV10T11		
YAV10L36BOX		8-10	—	0.29	0.86	0.71	0.23	YAV10L36		
YAV10BOX		8-10	105	0.36	0.97	0.79	0.25	YAV10*		
YAV10T3BOX		1/4	—	0.45	1.10	0.87	0.32	YAV10T3		
YAV10T2BOX		5/16	106	0.53	1.13	0.87	0.31	YAV10T2*		
YAV10T4BOX		3/8	128	0.53	1.20	0.88	0.36	YAV10T4*		
YAV9CL36BOX	10-9 Str.	8-10	—	0.31	0.94	0.83	0.15	YAV9CL36	Ratchet: MR89Q, Y8MRB1	7/16"
YAV9CT9BOX		1/4	—	0.44	1.15	0.95	0.31	YAV9CT9		
YAV9CT4BOX		5/16	—	0.52	1.23	1.02	0.36	YAV9CT4		

■ Use #14 groove

† UL Listed for 14 Str. to #10 Sol. & Str. when installed with MR8G98 and Y8MRB1 tools only.

* Class 1 & 2 connectors

◆QPL Class II when installed with MR89Q tool

TYPES YAV-L / YAV-LBOX

HYLUG™

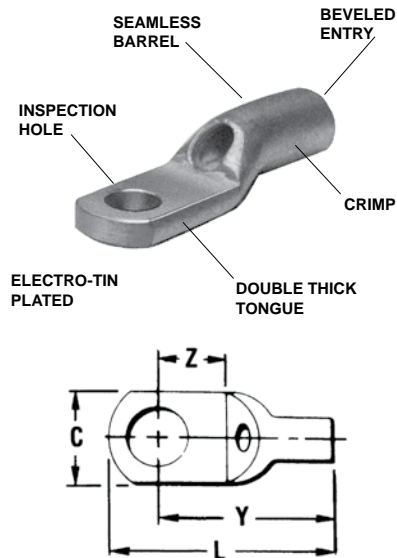

HYLUG™ Type YAV is a seamless, heavy duty uninsulated compression terminal manufactured from electrolytic copper and is for use on Type AN aircraft cable, extra flexible conductors and commercial (code) conductors. The seamless tubing produces a double thick tongue and seamless barrel design provides a strong connector for demanding applications requiring high reliability.

Applications include aircraft, industrials, hospitals, electric utilities, marine, computers, and other equipment subject to vibration or requiring dependable electrical performance. The YAV HYLUG™ terminals meet the requirements of SAE-AS7928 and are listed per AS20659 for use with copper aircraft cable constructed in accordance with SAE-AS29606.

The benefits of YAV-L connectors are the same as YAV connectors for stranded conductors



NOTE: Field bending straight lugs to achieve an angular connection will void UL Listing / CSA Certifications and BURNDY will not be liable for the connection.

Catalog Number	Wire Range (AWG/kcmil)	Stud Size	SAE - AS20659 Dash No. †	Dimensions (Inches)				Bulk Catalog Number	Installation Tooling				Wire Strip Length	
				C	L Max.	Y Max.	Z Max.		HYTOOL™ ■	Die Index	HYPRESS™			
											Y29 Series	35, 750 Series ▲		
YAV8CLBOX	8 Aircraft AN 8 Flex	8-10	-107	0.41	1.15	0.94	0.28	YAV8CL●	Non-Ratchet: MY29-1 Ratchet: MR4C, MR89Q, Y8MRB1, M8ND w/ N8CT Die Set	38	DV8L1 Nest Y29PL Indentor (1) Crimp	◆UV8L Nest Y34PL Indentor (1) Crimp	1/2"	
YAV8CL1BOX		1/4	-141	0.46	1.22	0.99	0.32							YAV8CL1●
YAV8CL2BOX		5/16	-108	0.57	1.30	1.01	0.34							YAV8CL2
YAV8CL3BOX		3/8	-129	0.57	1.30	1.01	0.34							YAV8CL3●
YAV8CL4BOX		1/2	-142	0.73	1.52	1.14	0.48							YAV8CL4●
YAV6CL1BOX	5 & 6 Aircraft AN 5 & 6 Flex	8-10	-130	0.46	1.31	1.06	0.29	YAV6CL1●	Non-Ratchet: MY28, MY2911 Ratchet: MR4C	39	DV6L Nest Y29PL Indentor (1) Crimp	◆UV6L Nest Y34PLA Indentor (1) Crimp	1/2"	
YAV6CLBOX		1/4	-109	0.50	1.28	1.06	0.29							YAV6CL●
YAV6CL4BOX		5/16	-131	0.58	1.43	1.13	0.35							YAV6CL4●
YAV6CL2BOX		3/8	-110	0.60	1.43	1.13	0.36							YAV6CL2●
YAV6CL10BOX		1/2	-143	0.74	1.64	1.26	0.49							YAV6CL10
YAV4CL3BOX	4 Aircraft AN 4 Flex	8-10	-144	0.55	1.37	1.11	0.28	YAV4CL3●	Non-Ratchet: MY28, MY2911 Ratchet: MR4C	40	DV4L Nest Y29PL Indentor (1) Crimp	◆UV4L Nest Y34PLA Indentor (1) Crimp	1/2"	
YAV4CLBOX		1/4	-111	0.55	1.37	1.11	0.28							YAV4CL
YAV4CL4BOX		5/16	-132	0.63	1.48	1.17	0.33							YAV4CL4●
YAV4CL2BOX		3/8	-112	0.63	1.48	1.17	0.33							YAV4CL2●
YAV4CL5BOX		1/2	-145	0.73	1.68	1.30	0.47							YAV4CL5
YAV2CL1BOX	2 Aircraft AN 2 Flex	1/4	-113	0.69	1.72	1.37	0.35	YAV2CL1●	Non-Ratchet: MY28, MY2911	41	DV2L Nest Y29PL Indentor (1) Crimp	◆UV2L Nest Y34PLA Indentor (1) Crimp	5/8"	
YAV2CL2BOX		5/16	-147	0.69	1.72	1.37	0.35	YAV2CL2●						
YAV2CLBOX		3/8	-114	0.69	1.72	1.37	0.35	YAV2CL●						
YAV2CL4BOX		1/2	-133	0.77	1.88	1.49	0.46	YAV2CL4						

† Class 1.

● Available in (90°) right angle design. Suffix "RS" replaces suffix "L".

▲ Use Y35P3 Indentor Adapter with 35 Series tools

■ Bench Mount Adaptor (Catalog Number: BMYBCHMT) is available for MY Series HYTOOL™

Add "NK" suffix for nickel plated terminals for high temperature applications up to 650° F continuous service and 750° intermittent service

◆QPL Class II tooling

TYPES YAV-L / YAV-LBOX (Continued)

NOTE: Field bending straight lugs to achieve an angular connection will void UL Listing / CSA Certifications and BURNDY will not be liable for the connection.

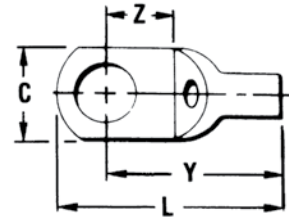
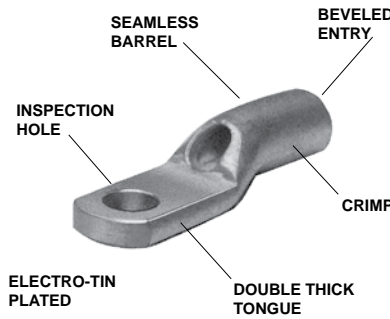

Catalog Number	Wire Range (AWG/kcmil)	Stud Size	SAE - AS20659 Dash No. †	Dimensions (Inches)				Bulk Catalog Number	Installation Tooling				
				C	L Max.	Y Max.	Z Max.		HYTOOL™	Die Index	HYPRESS™		Wire Strip Length
											Y29 Series	35, 750 Series ▲	
YAV1CL1BOX	1 Aircraft AN 1 Flex	1/4	-115	0.76	1.84	1.45	0.38	YAV1CL1 ●	42	DV1L Nest Y29PL Indentor (1) Crimp	◆UV1L Nest Y34PLA Indentor (1) Crimp	5/8"	
YAV1CL2BOX		5/16	-149	0.76	1.84	1.45	0.38						YAV1CL2 ●
YAV1CLBOX		3/8	-116	0.76	1.84	1.45	0.38						
YAV1CL3BOX		1/2	-134	0.86	1.97	1.54	0.46						YAV1CL3
YAV25L1BOX	1/0 Aircraft AN 1/0 Flex	1/4	-117	0.83	2.01	1.61	0.43	YAV25L1	43	DV25L Nest Y29PR Indentor (1) Crimp	◆UV25L Nest Y34PA Indentor (1) Crimp	11/16"	
YAV25L2BOX		5/16	-151	0.83	2.03	1.61	0.43	YAV25L2					
YAV25LBOX		3/8	-118	0.83	2.03	1.61	0.43	YAV25L ●					
YAV25L3BOX		1/2	-135	0.88	2.09	1.64	0.46	YAV25L3 ●					
YAV25L4BOX		5/8	—	0.88	2.31	1.80	0.62	YAV25L4					
YAV26L1BOX	2/0 Aircraft AN 2/0 Flex	1/4	-153	0.93	2.32	1.85	0.48	YAV26L1	44	DV26L Nest Y29PR Indentor (1) Crimp	◆UV26L Nest Y34PA Indentor (1) Crimp	13/16"	
YAV26L2BOX		5/16	-119	0.93	2.32	1.85	0.48	YAV26L2					
YAV26LBOX		3/8	-120	0.93	2.32	1.85	0.48	YAV26L ●					
YAV26L3BOX		1/2	-136	0.93	2.32	1.85	0.48	YAV26L3 ●					
YAV26L12BOX		5/8	—	0.93	2.52	1.99	0.62	YAV26L12					
YAV27LBOX	3/0 Aircraft AN 3/0 Flex	3/8	-121	1.03	2.45	1.93	0.52	YAV27L ●	45	—	◆UV27L Nest Y34PA Indentor (1) Crimp	13/16"	
YAV27L1BOX		1/2	-122	1.03	2.45	1.93	0.52	YAV27L1					
YAV27L15BOX		5/8	—	1.03	2.60	2.03	0.62	YAV27L15					
YAV28L53BOX	4/0 Aircraft AN 4/0 Flex	1/4	—	1.12	2.28	1.83	0.28	YAV28L53	46	—	◆UV28L Nest Y34PA Indentor (1) Crimp	7/8"	
YAV28LBOX		3/8	-123	1.12	2.72	2.16	0.60	YAV28L					
YAV28L12BOX		1/2	-124	1.12	2.72	2.16	0.60	YAV28L12					
YAV28L13BOX		5/8	-159	1.12	2.72	2.16	0.60	YAV28L13					
YAV28L14BOX		3/4	-160	1.23	2.95	2.33	0.78	YAV28L14					

- † Class 1.
- Available in (90°) right angle design. Suffix "RS" replaces suffix "L".
- ▲ Use Y35P3 Indentor Adapter with 35 Series tools
- Bench Mount Adaptor (Catalog Number: BMYBCHMT) is available for MY Series HYTOOL™
- Add "NK" suffix for nickel plated terminals for high temperature applications up to 650° F continuous service and 750° intermittent service
- ◆QPL Class II tooling

TYPES YAV-H / YAV-H BOX

HYLUG™

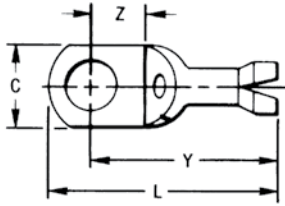

The Type YAV-H HYLUG™ is a seamless heavy duty uninsulated compression ring tongue terminal with a shroud for an insulation grip and cable support. They are manufactured from pure electrolytic copper tubing for use on copper commercial (code) cable, Type AN aircraft cable and extra flexible conductors.

The seamless design produces a double thick tongue and the seamless barrel provides a strong highly reliable connection. Meets the requirements of SAE-AS7928. The benefits of the Type YAV apply to the YAV-H HYLUG™

Features & Benefits

- Shroud/insulation grip cable support and strain relief protects the wire against breaking under vibration or flexing conditions
- Electro-tin plated to provide long-lasting corrosion resistance



NOTE: Field bending straight lugs to achieve an angular connection will void UL Listing / CSA Certifications and BURNDY will not be liable for the connection.

Catalog Number	Wire Range AWG, AN, Aircraft	Stud Size	Max. Insul. Dia. Accom.	Dimensions				Bulk Catalog Number	Installation Tooling	Dies	Wire Strip Length
				C	L Max.	Y Max.	Z Min.				
YAV18HBOX	22-18	8 - 10	0.120"	0.31	0.88	0.76	0.24	YAV18H	Plier: Y10D, Y1022*	M8ND, with N14HT, N14HT5 Die	9/32"
YAV14H1BOX	16-14	6 - 8	0.150"	0.31	0.92	0.80	0.24	YAV14H1			9/32"
YAV14HBOX	20-14	8 - 10	0.150"	0.31	0.95	0.80	0.24	YAV14H		Ratchet: MR8G98, MR89Q, Y8MRB1*, MR20, M8ND, MRE1022B	M8ND, N10HT24
YAV14H2BOX		1/4		0.42	1.14	0.90	0.32	YAV14H2			
YAV10H25BOX	12-10	6 - 8	0.192"	0.31	1.00	0.90	0.24	YAV10H25			
YAV10HBOX		8 - 10		0.38	1.05	0.91	0.24	YAV10H			
YAV10H3BOX		1/4		0.47	1.22	0.99	0.32	YAV10H3			

* For conductor crimp only.

TYPES YAEV / YAEV-L

INSULUG™

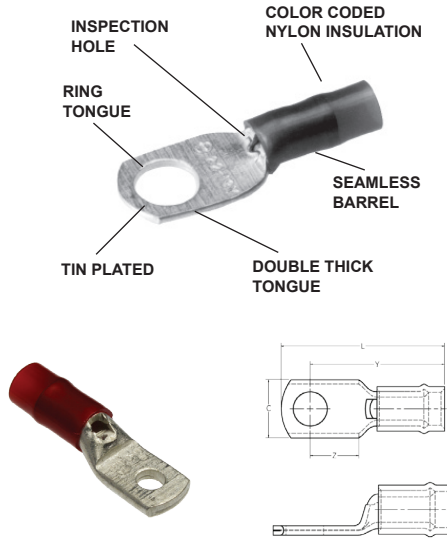

NOTE: Field bending straight lugs to achieve an angular connection will void UL Listing / CSA Certifications and BURNDY will not be liable for the connection.

600 Volts Max., 105°C, Max.

The INSULUG™ type YAEV is designed for very demanding high vibration applications encountered in aircraft and aboard ships as well as motor lead applications in hospitals, industrials and generating plants. The nylon insulated seamless, electrolytic copper barrel with double thick tongue provides an extra strong insulated connection. The terminal is rated 105°C and meets SAE-AS7928 requirements.

Features & Benefits

- Double thick tongue for maximum reliability and electrical capacity plus an extra strong terminal tongue
- Manufactured from one-piece pure electrolytic copper — high conductivity, low resistance with no seams to split plus ductility for excellent crimp forming properties
- Electro-tin plated to provide long-lasting corrosion resistance
- Nylon insulation is locked in place — Insulation will not move or twist off
- 300 volt nylon insulation providing high dielectric strength and stability in demanding oily environmental conditions
- Color Coded providing quick, easy wire size connector selection

Catalog Number	Wire Range AWG, AN Aircraft	Stud Size	Dimensions				Bulk Catalog Number	Installation Tooling	Wire Strip Length
			C	Z Min.	Y Max.	L Max.			
YAEV18BOX	22-18 Max. Insul. Dia. Accom.: .125 Color Code: Red	8-10	0.31	0.24	0.77	0.91	YAEV18	Ratchet: MR8D94, MRE1022NV	1/4"
YAEV14BOX	18-14 AN, 16-14 AWG Max. Insul. Dia. Accom.: .154 Color Code: Blue	8-10	0.31	0.24	0.81	0.94	YAEV14	Ratchet: MR8D94, MRE1022NV	1/4"
YAEV10T7BOX	12-10 Max. Insul. Dia. Accom.: .209 Color Code: Yellow	4-6	0.30	0.24	0.95	1.12	YAEV10T7	Ratchet: MR8D94 MR833T1 M8ND with N10ET9 Die MR4 10M MRE1022NV	5/16"
YAEV10T11BOX		6-8	0.37	0.26	0.97	1.16	YAEV10T11		
YAEV10BOX		8-10	0.37	0.26	0.97	1.16	YAEV10		
YAEV10L36BOX		8-10	0.30	0.18	0.89	1.04	YAEV10L36		
YAEV10T3BOX		1/4	0.47	0.38	1.12	1.30	YAEV10T3		
YAEV10T2BOX		5/16	0.53	0.31	1.12	1.36	YAEV10T2		
YAEV10T4BOX		3/8	0.56	0.35	1.12	1.38	YAEV10T4		

TYPES YAEV / YAEV-L (Continued)

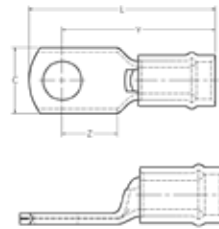

NOTE: Field bending straight lugs to achieve an angular connection will void UL Listing / CSA Certifications and BURNDY will not be liable for the connection.

Catalog Number	Wire Range AWG, AN Aircraft	Stud Size	AS25036- No.	Dimensions				Bulk Catalog Number	Installation Tooling	HYPRESS™ Y29 Series		Wire Strip Length
				C	Z Min.	Y Max.	L Max.			Nest	Indentor	
YAEV8CL14BOX	8 Str. Max. Insul. Dia. Accom.: .258 Color Code: Red	8	—	0.41	0.28	1.18	1.40	YAEV8CL14	Ratchet: M8ND with N8CET2 Die Non-Ratchet: MY286* Hydraulic: 35, 750 Series with U8CET Die Set	DEV8L	Y29PLE1	7/16"
YAEV8CL1BOX		1/4	-116	0.46	0.32	1.23	1.47	YAEV8CL1				
YAEV8CL2BOX		5/16	-117	0.57	0.34	1.25	1.54	YAEV8CL2				
YAEV8CL3BOX		3/8	-118	0.57	0.34	1.25	1.54	YAEV8CL3				
YAEV8CL4BOX		1/2	—	0.73	0.48	1.39	1.77	YAEV8CL4				
YAEV8CLBOX		10	-115	0.41	0.28	1.18	1.40	YAEV8CL				
YAEV6CL1BOX	6 Str. Max. Insul. Dia. Accom.: .313 Color Code: Blue	8-10	-119**	0.48	0.29	1.33	1.56	YAEV6CL1**	Non-Ratchet: MY286* Hydraulic: 35, 750 Series with U6CET Die Set	DEV6L	Y29PLE1	1/2"
YAEV6CLBOX		1/4	-120**	0.48	0.29	1.33	1.56	YAEV6CL**				
YAEV6CL4BOX		5/16	-121**	0.60	0.36	1.39	1.68	YAEV6CL4**				
—		3/8	-122**	0.60	0.36	1.39	1.68	YAEV6CL2**				
YAEV6CL10BOX		1/2	—	0.73	0.47	1.53	1.91	YAEV6CL10				
YAEV4CL3BOX	4 Str. Max. Insul. Dia. Accom.: .374 Color Code: Yellow	8-10	—	0.55	0.28	1.40	1.62	YAEV4CL3	Non-Ratchet: MY286* Hydraulic: 35, 750 Series with U4CET Die Set	DEV4L	Y29PLE1	1/2"
YAEV4CLBOX		1/4	-123	0.55	0.28	1.37	1.62	YAEV4CL				
YAEV4CL4BOX		5/16	-124	0.63	0.34	1.43	1.74	YAEV4CL4				
—		3/8	-125	0.63	0.34	1.43	1.74	YAEV4CL2				
—		1/2	—	0.73	0.47	1.56	1.92	YAEV4CL5				
YAEV2CL3BOX	2 Str. Max. Insul. Dia. Accom.: .459 Color Code: Red	10	—	0.69	0.35	1.72	2.03	YAEV2CL3	Non-Ratchet: MY286* Hydraulic: 35, 750 Series with U2CET Die Set	DEV2L	Y29PLE	5/8"
YAEV2CL1BOX		1/4	-126	0.69	0.35	1.61	2.03	YAEV2CL1				
YAEV2CL2BOX		5/16	—	0.69	0.35	1.68	2.03	YAEV2CL2				
YAEV2CLBOX		3/8	-127	0.69	0.35	1.69	2.03	YAEV2CL				
—		1/2	-128	0.77	0.47	1.80	2.16	YAEV2CL4				
—	1 Str. Max. Insul. Dia. Accom.: .516 Color Code: White	1/4	-129	0.76	0.38	1.63	2.14	YAEV1CL1	Non-Ratchet: MY286* Hydraulic: 35, 750 Series with U1CET Die Set	DV26L	Y29PLE	5/8"
—		5/16	—	0.76	0.38	1.71	2.14	YAEV1CL2				
YAEV1CLBOX		3/8	-130	0.76	0.38	1.72	2.14	YAEV1CL				
—		1/2	-131	0.86	0.47	1.86	2.27	YAEV1CL3				
—	1/0 Str. Max. Insul. Dia. Accom.: .564 Color Code: Blue	1/4	-132	0.83	0.43	1.97	2.40	YAEV25L1	Non-Ratchet: MY286* Hydraulic: 35, 750 Series with U25ET Die Set	DEV25L	Y29PLE	11/16"
—		5/16	—	0.83	0.43	1.97	2.40	YAEV25L2				
—		3/8	-133	0.83	0.43	1.97	2.40	YAEV25L				
—		1/2	-134	0.88	0.47	2.02	2.46	YAEV25L3				
—		5/8	—	0.88	0.63	2.17	2.67	YAEV25L4				
—	2/0 Str. Max. Insul. Dia. Accom.: .628 Color Code: Yellow	1/4	—	0.93	0.49	2.19	2.72	YAEV26L1	Non-Ratchet: MY286* Hydraulic: 35, 750 Series with U26ET Die Set	DEV26L	Y29PLE	13/16"
—		5/16	-135	0.93	0.49	2.19	2.72	YAEV26L2				
YAEV26LBOX		3/8	-136	0.93	0.49	2.19	2.72	YAEV26L				
YAEV26L3BOX		1/2	-137	0.93	0.49	2.27	2.72	YAEV26L3				

† Additional terminal stud sizes available.

* Bench Mount Adaptor (Catalog Number: BMYBCHMT) is available for MY Series HYTOOL™

** NOTE: Add suffix "M" to cat. number to conform to AS25036 - standard for these items only
(example: YAEV6C-L1M). See above. Contact BURNDY® for UL Listed products.

TYPES YAV-R, YAV-RS

HYLUG™

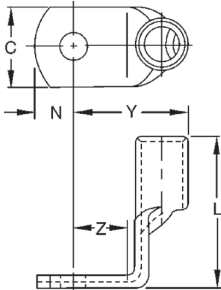

Factory formed right angle HYLUG™ connectors made of seamless pure copper tubing. These rugged terminals withstand the most severe applications. Inspection hole in barrel permits visual check of wire insertion. Tin plated to resist corrosion. Meets requirements of SAE-AS7928.



NOTE: Field bending straight lugs to achieve an angular connection will void UL Listing / CSA Certifications and BURNDY will not be liable for the connection.

Catalog Number	Wire Range (AWG/kcmil)	Stud Size	Dimensions					Installation Tooling	Wire Strip Length
			C	L Max.	Y Max.	Z Min.	N		
YAV18R	22-18	8-10	0.31	0.34	0.46	0.25	0.16	Non-Ratchet: Y10D Ratchet: Y8MRB1, MR20, MR8G98, MR89Q	1/4
YAV14RL33	20-14	4-6	0.25	0.37	0.45	0.21	0.12		
YAV14R		8-10	0.31	0.36	0.48	0.25	0.16		
YAV10R	12-10	8-10	0.38	0.53	0.46	0.25	0.19		5/16
YAV10R3BOX	12-10	1/4	0.47	0.55	0.50	.28	0.23		5/16

Catalog Number	Wire Range AWG, AN, Aircraft	Stud Size	Dimensions in Inches					Installation Tooling		Wire Strip Length	Tool ▲ Index Number	
			C	L Max.	Y Max.	Z Min.	N	Aircraft	HYPRESS™ Y29 Series			
									Nest			Indentor
YAV8CRS	8	8-10	0.41	0.95	0.62	0.25	0.20	MY28 MY2911	Y29PL	7/16	38	
YAV8CRS1		1/4	0.41	0.95	0.65	0.28	0.20					DV8L*
YAV8CRS3		3/8	0.56	0.95	0.71	0.34	0.31					
YAV6CRS1	6	8-10	0.50	0.98	0.67	0.28	0.25	MY28 MY2911	Y29PL	1/2	39	
YAV6CRS		1/4	0.50	0.98	0.67	0.28	0.25					DV6L
YAV6CRS4		5/16	0.59	0.98	0.73	0.34	0.31					
YAV4CRS3	4	8-10	0.53	1.00	0.70	0.28	0.25	MY28 MY2911	Y29PL	1/2	40	
YAV4CRS		1/4	0.53	1.00	0.70	0.28	0.25					DV4L
YAV4CRS4		5/16	0.62	1.00	0.77	0.34	0.31					
YAV4CRS2		3/8	0.62	1.00	0.77	0.34	0.31					
YAV2CRS1	2	1/4	0.68	1.27	0.82	0.34	0.33	MY28 MY2911	Y29PR	5/8	41	
YAV2CRS2		5/16	0.68	1.27	0.82	0.34	0.33					DV2L
YAV2CRS		3/8	0.68	1.27	0.82	0.34	0.33					
YAV1CRS1	1	1/4	0.73	1.31	0.88	0.34	0.33	MY28 MY2911	Y29PR	5/8	42	
YAV1CRS2		5/16	0.73	1.31	0.88	0.34	0.33					DV1L
YAV25RS	1/0	3/8	0.81	1.35	1.01	0.44	0.39	MY28 MY2911	Y29PR	11/16	43	
YAV25RS3		1/2	0.88	1.35	1.04	0.47	0.44					DV25L
YAV26RS	2/0	3/8	0.92	1.58	1.00	0.47	0.39	MY28 MY2911	Y29PR	13/16	44	
YAV26RS3		1/2	0.92	1.58	1.00	0.47	0.39					DV26L
YAV27RS	3/0	3/8	1.02	1.61	1.12	0.47	0.48	—	—	7/8	45	
YAV28RS	4/0	3/8	1.12	1.75	1.15	0.47	0.48	—	—	7/8	46	

* For aircraft applications (Flexible Cable) use die DV8L1

▲ See Present Installation Tool Index

TYPE YAEV-RS

INSULUG™

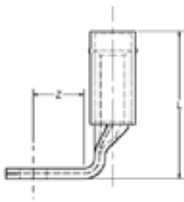
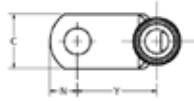

600 Volts Max.; 105° C Max.

Factory formed right angle INSULUG™ connectors made of seamless pure copper tubing. These rugged terminals withstand the most severe applications. Inspection hole in barrel permits visual check of wire insertion. Meets requirements of SAE-AS7928.

NOTE: Field bending straight lugs to achieve an angular connection will void UL Listing / CSA Certifications and BURNDY will not be liable for the connection.

Catalog Number	Wire Range	Stud Size	N	C	Z Min.	Y Max.	L Max.	Installation Tooling			Wire Strip Length
								HYTOOL™	HYPRESS™ Y29 Series		
									Nest	Indentor	
YAEV8CRS	8	8-10	0.20	0.41	0.25	0.82	1.25	A	DEV8L	Y29PLE1	7/16"
YAEV8CRS1	Max. Insul. Dia.: .258" Sleeve Color: Red	1/4	0.25	0.41	0.28	0.84	1.25				
YAEV6CRS1	6	8-10	0.25	0.50	0.28	0.88	1.28	B	DEV6L	Y29PLE1	1/2"
YAEV6CRS	Max. Insul. Dia.: .313" Sleeve Color: Blue	1/4	0.25	0.50	0.28	0.88	1.28				
YAEV4CRS	4	1/4	0.25	0.53	0.28	0.95	1.28	C	DEV4L	Y29PLE1	1/2"
YAEV4CRS2	Max. Insul. Dia.: .374" Sleeve Color: Yellow	3/8	0.31	0.62	0.34	1.02	1.28				
YAEV2CRS1	2	1/4	0.33	0.68	0.34	1.13	1.59	D	DEV2L	Y29PLE	5/8"
YAEV2CRS	Max. Insul. Dia.: .459" Sleeve Color: Red	3/8	0.33	0.68	0.34	1.13	1.59				
YAEV1CRS2	1	5/16	0.33	0.73	0.34	1.13	1.65	E	DV26L	Y29PLE	5/8"
YAEV1CRS	Max. Insul. Dia.: .516" Sleeve Color: White	3/8	0.33	0.73	0.34	1.22	1.65				
YAEV25RS	1/0	3/8	0.39	0.81	0.44	1.46	1.88	F	DEV25L	Y29PLE	11/16"
YAEV26RS	2/0	3/8	0.39	0.92	0.47	1.48	2.06	G	DEV26	Y29PLE	13/16"

A	B	C	D	E	F	G
Ratchet: M8ND with N8CET2 Die Non-Ratchet: MY286†† Hydraulic: 35, 750 Series with U8CET Die Set	Non-Ratchet: MY286†† Hydraulic: 35, 750 Series with U6CET Die Set	Non-Ratchet: MY286†† Hydraulic: 35, 750 Series with U4CET Die Set	Non-Ratchet: MY286†† Hydraulic: 35, 750 Series with U2CET Die Set	Non-Ratchet: MY286†† Hydraulic: 35, 750 Series with U1CET Die Set	Non-Ratchet: MY286†† Hydraulic: 35, 750 Series with U25ET Die Set	Non-Ratchet: MY286†† Hydraulic: 35, 750 Series with U26ET Die Set

†† Bench Mount Adaptor (Catalog Number: BMYBCHMT) is available for MY Series HYTOOL™

Small Terminals

Flag-Type Ring Tongue Compression Terminals

TYPE YBM

HYLUG™



Made of pure electrolytic copper for maximum conductivity and ductility. Seamless extrusion tin plated to resist corrosion.

NOTE: Field bending straight lugs to achieve an angular connection will void UL Listing / CSA Certifications and BURNDY will not be liable for the connection.

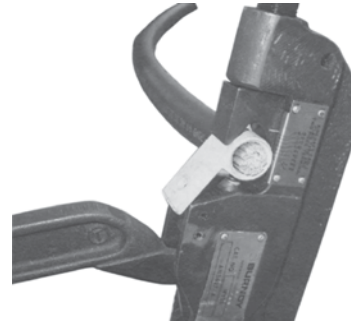

Catalog* Number	Wire Range		Stud Size	Dimensions in Inches				HYTOOL™	Installation Tooling				Wire Strip Length
	Flex	Code		C Max.	Z Min.	Y Approx.	L Max.		HYPRESS™ Y29 Series		35, 750 Series		
									Nest	Indentor	Nest	Indentor	
YBM8C	8	8	8-10	0.47	0.33	0.59	1.01	MY28	DV8B	Y29PBL	UV8B1	Y29PBL	7/16"
YBM8CT2			1/4	0.53	0.36	0.62	1.07						1/2"
YBM8CT4			3/8	0.66	0.42	0.68	1.19						9/16"
YBM6CL9	6	6	8-10	0.53	0.36	0.64	1.09	MY28	DV6BL1	Y29PBL	UV6B1	Y29PBL	1/2"
YBM6CL			1/4	0.53	0.36	0.64	1.12						9/16"
YBM6CL2			5/16	0.59	0.42	0.70	1.21						5/8"
YBM6CL3			3/8	0.66	0.42	0.70	1.24						
YBM4CL4	4	4	8-10	0.53	0.36	0.69	1.18	MY28	DV4BL	Y29PBL	UV4B1	Y29PL	1/2"
YBM4CL			1/4	0.53	0.36	0.69	1.21						9/16"
YBM4CL1			5/16	0.59	0.42	0.75	1.3						5/8"
YBM4CL2			3/8	0.66	0.42	0.75	1.33						
YBM2CL1	2	2	1/4	0.66	0.36	0.73	1.28	MY28	DV2BL	Y29PL	UV2B1	Y29PA	5/8"
YBM2CL2			5/16	0.66	0.42	0.79	1.38						
YBM2CL			3/8	0.66	0.42	0.79	1.35						
YBM1CL3	1	1	1/2	0.91	0.61	1.00	1.78	MY28	DV1BL	—	—	—	1"
YBM1CL			3/8	0.66	0.49	0.88	1.53						5/8"
YBM25L1	1/0	—	1/4	0.72	0.42	0.86	1.49	MY28	DV25BL1	Y29PR	UV25B1	Y29PA1	5/8"
YBM25L2			5/16	0.72	0.45	0.88	1.56						3/4"
YBM25L			3/8	0.72	0.49	0.92	1.62						
YBM26L	2/0	—	3/8	0.84	0.49	0.98	1.71	MY28	DV26L	Y29PR	UV26B1	Y29PA1	13/16"

* Lead Plated available, contact factory.

■ UL Listed with MY28 and Y29 series tools only.

TYPES T-F / YAD-F

HYLUG™

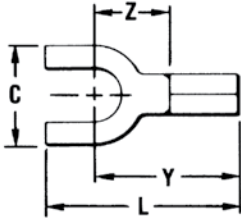

Type T-F is constructed in the same manner as the type "T" and employs a fork tongue. The fork permits rapid installation of the terminal under a screw head without completely removing the screw. Two or more terminals may be stacked easily on a common stud.

Features & Benefits

- Fork tongue design for faster installation
- Screw needs only to be loosened (not completely removed) for termination

NOTE: Field bending straight lugs to achieve an angular connection will void UL Listing / CSA Certifications and BURNDY will not be liable for the connection.

Catalog Number	Wire Range	Stud Size	C	L Max	Y Max	Z Min	Bulk Catalog Number	Installation Tooling	Wire Strip Length
T186F	22 AWG-18 AWG	#4 - #6	0.28	0.68	0.55	0.25	YAD186F	Non-Ratchet: Y10D, Y1022 Ratchet: MRE1022B, MR8G98, Y8MRB1, MR20	9/32
T188F		#6 - #8	0.31	0.74	0.57	0.27	YAD188F		
T1810F		#8 - #10	0.37	0.74	0.58	0.29	YAD1810F		
T1814F		1/4	0.47	0.92	0.69	0.39	YAD1814F		
T146F	20 AWG-14 AWG	#4 - #6	0.28	0.68	0.55	0.25	YAD146F	Non-Ratchet: Y10D, Y1022 Ratchet: MRE1022B, MR8G98, Y8MRB1, MR20	9/32
T148F		#6 - #8	0.31	0.74	0.57	0.27	YAD148F		
T1410F		#8 - #10	0.37	0.74	0.58	0.29	YAD1410F		
T1414F		1/4	0.47	0.92	0.69	0.39	YAD1414F		
T106F	14 AWG-10 AWG (Str.) 12 AWG-10 AWG (Sol.)	#4 - #6	0.28	0.74	0.61	0.25	YAD106F	Non-Ratchet: Y10D, Y1022 Ratchet: MRE1022B, MR8G98, Y8MRB1, MR20	11/32
T108F		#6 - #8	0.31	0.80	0.63	0.27	YAD108F		
T1010F		#8 - #10	0.41	0.87	0.68	0.32	YAD1010F		
T1014F		1/4	0.50	1.00	0.75	0.39	YAD1014F		

TYPES YAV-T-F / YAV-T-F BOX

HYLUG™

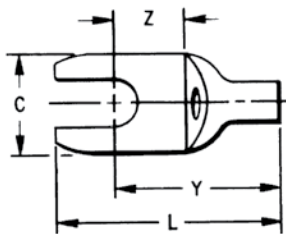
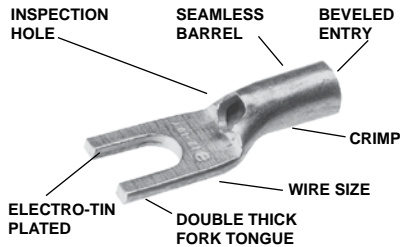

The Type YAV-T-F HYLUG™ is a seamless heavy duty uninsulated compression fork-tongue terminal manufactured from electrolytic copper for use on copper commercial (code) cable, Type AN aircraft cable and extra flexible conductors.

The seamless design produces a double thick tongue and the seamless barrel provides a strong highly reliable connection.

All the benefits of the Type YAV apply for the same wire sizes.

Features & Benefits

- Fork tongue allows installation of compression terminal under screw head without complete removal of the screw



NOTE: Field bending straight lugs to achieve an angular connection will void UL Listing / CSA Certifications and BURNDY will not be liable for the connection.

Catalog Number	Wire Range	Stud Size	C	L	Y	Z	Bulk Catalog Number	Installation Tooling	Wire Strip Length
YAV18T19FBOX	22-18	#4-#6	0.31	0.84	0.55	0.25	YAV18T19F	Non-Ratchet: Y10D, Y1022 Ratchet: MR8G98, MR89Q, MR20, Y8MRB1, MRE1022B	9/32"
YAV18T21FBOX	20-18	#8-#10	0.37	0.84	0.55	0.25	YAV18T21F		
YAV14T32FBOX	20-14	#4-#6	0.31	0.84	0.57	0.25	YAV14T32F		
YAV14T34FBOX		#8-#10	0.37	0.82	0.60	0.26	YAV14T34F		
YAV10T21FBOX	12-10	#8-#10	0.36	0.99	0.69	0.26	YAV10T21F	7/16"	
YAV10T23FBOX		1/4	0.47	1.03	0.75	0.34	YAV10T23F		

TYPES TP-F / BA-EF

VINYLUG™



600 Volts Max.; 105° C Max.

The Type TP-F is a fork tongue variation of the TP design and makes installation easier.

Features & Benefits

- Fork tongue design for faster installation
- Screw needs only to be loosened (not completely removed) for termination

NOTE: Field bending straight lugs to achieve an angular connection will void UL Listing / CSA Certifications and BURNDY will not be liable for the connection.

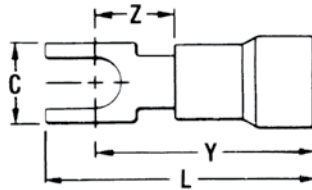
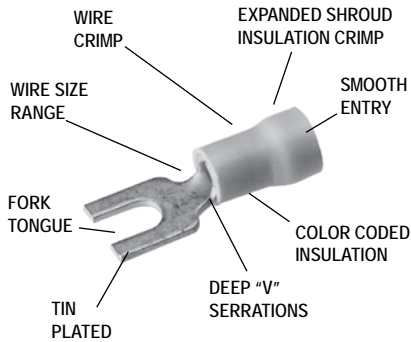

Catalog Number	Wire Range	Stud Size	Dimensions				Bulk Catalog Number *	Installation Tooling	Tape Mounted Catalog Number 2000/Reel	Tape Fed Installation Tooling	Wire Strip Length
			C	L. Max	Y Max.	Z Min.					
TP162F	22 - 16 Max. Insul. Dia. Accom.: 0.15 Color Code: Red	#1-#2	0.17	0.75	0.66	0.23	BA16EF2	Plier Type: Y1022 Ratchet Tool: MRE1022NV MR8891	BA16EF2M	OEM175TFM with TFM2218NV Die	13/64"
TP166F		#4-#6	0.28	0.80	0.66	0.23	BA16EF6		BA16EF6M		
TP168F		#6-#8	0.31	0.86	0.69	0.26	BA16EF8		BA16EF8M		
TP1610F		#8-#10	0.41	0.95	0.75	0.31	BA16EF10		BA16EF10M		
TP142F	16 - 14 Max. Insul. Dia. Accom.: 0.18 Color Code: Blue	#1-#2	0.17	0.75	0.66	0.23	BA14EF2	Plier Type: Y1022 Ratchet Tool: MRE1022NV MR8891	—	OEM175TFM with TFM1614NV Die	13/64"
TP146F		#3-#6	0.28	0.80	0.66	0.23	BA14EF6		—		
TP148F		#6-#8	0.31	0.86	0.69	0.26	BA14EF8		BA14EF8M		
TP1410F		#8-#10	0.41	0.95	0.75	0.31	BA14EF10		BA14EF10M		
TP106F	12 - 10 Max. Insul. Dia. Accom.: 0.26 Color Code: Yellow	#3-#6	0.28	0.95	0.81	0.26	BA10EF6	MRE1022NV, MR15, M8ND with N10ET23	*BA10EF6M	OEM175TFM with TFM1210NV Die	19/64"
TP108F		#6-#8	0.31	0.98	0.81	0.26	BA10EF8		*BA10EF8M		
TP1010F		#8-#10	0.41	1.07	0.87	0.31	BA10EF10		*BA10EF10M		

* UL Listed and CSA Certified with MR8891 and MR15 only
* 1000/Box



MRE1022NV Ergonomic Hand Tool perfect for use with the TP-F; suitable for most nylon and vinyl insulated small terminals. MRE1022B is designed for use with bare (uninsulated) terminals. Part of the BURNDY Engineered System of coordinating connectors, tools and dies for a quality, reliable, repeatable connection.

See the Tooling section for more information on this and other BURNDY Tools.

Small Terminals

Nylon Insulated Fork Tongue Compression Terminals

TYPES TN-F / YAES-F

INSULUG™



600 Volts Max.; 105° C Max.

The Type TN-F, nylon insulated fork tongue terminal has the same high quality as the TN. It is designed to meet the heavy-duty requirements of industrial and utility applications.

Used on both power and control circuits for wire sizes #26 AWG through #10 AWG. The TN-F provides high dielectric strength and stability in oily conditions.

The TN-F is identical to the TN with the addition of a fork tongue which allows installation without complete removal of its supporting screw.

Features & Benefits

- Fork tongue design for faster installation
- Screw needs only to be loosened (not completely removed) for termination

NOTE: Field bending straight lugs to achieve an angular connection will void UL Listing / CSA Certifications and BURNDY will not be liable for the connection.

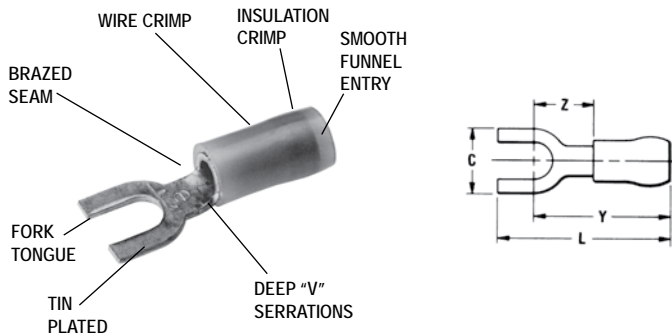

Catalog Number	Wire Range	Stud Size	Dimensions				Bulk Catalog Number	Installation Tooling	Wire Strip Length
			C	L Max.	Y Max.	Z Min.			
TN202F*	26-20 Max. Insul. Dia. Accom.: 0.10 Color Code: Amber	#1 - #2	0.18	0.76	0.65	0.24	—	M8ND with N14HET25V1 Die Set	3/16"
TN206F*		#4 - #6	0.28	0.80	0.70	0.28	—		
TN184F*	22-18 Max. Insul. Dia. Accom.: 0.12 Color Code: Red	#3 - #4	0.23	0.75	0.65	0.24	—	Non-Ratchet: Y10D Y1022 Ratchet: MRE1022NV MR883** MR18	7/32"
TN186F		#4 - #6	0.28	0.79	0.65	0.24	YAES18N1F		
TN188F		#6 - #8	0.31	0.84	0.67	0.26	YAES18N49F		
TN1810F		#8 - #10	0.37	0.84	0.68	0.27	YAES18N3F		
TN1814F		1/4	0.47	1.03	0.79	0.38	YAES18N50F		
TN146F	16-14 Max. Insul. Dia. Accom.: 0.15 Color Code: Blue	#4 - #6	0.28	0.79	0.65	0.24	YAES14N6F	Non-Ratchet: Y10D Y1022 Ratchet: MRE1022NV MR883** MR18	7/32"
TN148F		#6 - #8	0.31	0.84	0.67	0.26	YAES14N53F		
TN1410F		#8 - #10	0.37	0.84	0.68	0.27	YAES14N8F		
TN1414F		1/4	0.47	1.03	0.79	0.38	YAES14N54F		
TN106F	12-10 Max. Insul. Dia. Accom.: 0.21 Color Code: Yellow	#4 - #6	0.28	0.96	0.82	0.24	YAES10N11F	Non-Ratchet: Y10D Y1022 Ratchet: MRE1022NV MR883** MR18	11/32"
TN108F		#6 - #8	0.31	1.01	0.84	0.26	YAES10N56F		
TN1010F		#8 - #10	0.41	1.09	0.89	0.31	YAES10N12F		
TN1014F		1/4	0.50	1.21	0.96	0.38	YAES10N57F		

* Not UL Listed or CSA Certified.

** Or other tool conforming to military specification AS25036 or AS90413

TYPES YAE-N-F / YAE-N-F BOX

600 Volts Max.; 105° C Max.

INSULUG™

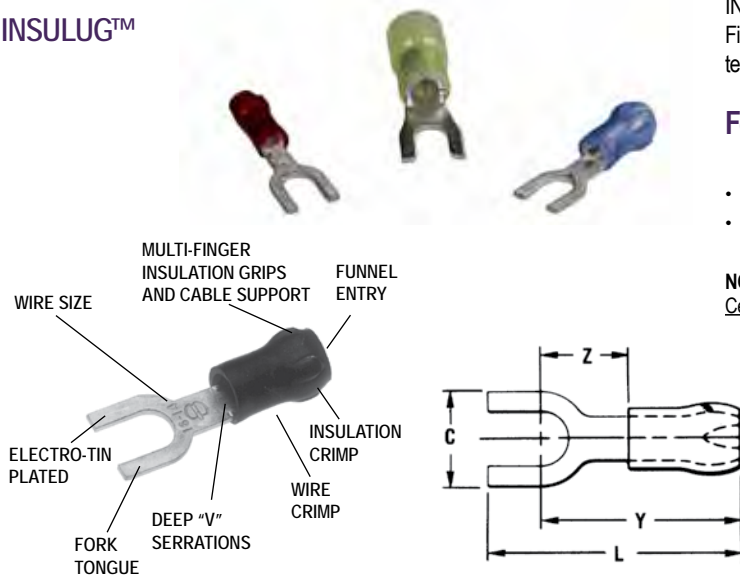

INSULUG™ type YAE-N-F nylon insulated terminals are designed with a Multi-Finger Insulation grip, are rated 105° C and are supplied with a fork tongue for easy terminal insertion and removal.

Features & Benefits

- Fork tongue design for faster installation
- Screw needs only to be loosened (not completely removed) for termination

NOTE: Field bending straight lugs to achieve an angular connection will void UL Listing / CSA Certifications and BURNDY will not be liable for the connection.



Catalog Number	Wire Range	Stud Size	Dimensions				Bulk Catalog Number	Installation Tooling**	Tape Mounted Catalog Number 2000/Reel	Tape Fed Installation Tooling	Wire Strip Length
			C	L Max.	Y Max.	Z Min.					
YAE22N65FBOX*	24 - 20 Max. Insul. Dia.: 0.10" Sleeve Color: Amber	#2	0.18	0.73	0.63	0.22	YAE22N65F	Ratchet: M8ND N14HET25V1 Die	YAE22N65FM	▲OEM175TFM with TFM2218NV Die	5/32"
YAE22N66FBOX*		#4 - #6	0.28	0.80	0.67	0.27	YAE22N66F		YAE22N66FM		
YAE18N60FBOX*	22 - 16 Max. Insul. Dia.: 0.13" Sleeve Color: Red	#4	0.21	0.92	0.73	0.24	YAE18N60F	Non-Ratchet: Y10D, Y1022 Ratchet: MRE1022NV, MR833T1, M8ND with one of the following dies: N14HET25V1, N10ET9, N14HET15, N10ET23	—	OEM175TFM with TFM2218NV Die	3/16"
YAE18G43FBOX		#4 - #6	0.25	0.78	0.68	0.18	YAE18G43F		YAE18G43FM		
YAE18N56FBOX†		#4 - #6	0.28	0.82	0.71	0.21	YAE18N56F		—		
YAE18N57FBOX		#6 - #8	0.31	0.96	0.77	0.28	YAE18N57F		YAE18N57FM		
YAE18N58FBOX		#8	0.36	1.02	0.82	0.33	—		—		
YAE14N76FBOX	16 - 14 Max. Insul. Dia.: 0.16" Sleeve Color: Blue	#4 - #6	0.28	0.85	0.74	0.25	YAE14N76F	Non-Ratchet: Y10D, Y1022 Ratchet: MR833T1, M8ND with one of the following dies: N14HET25V1, N10ET9, N14HET15, N10ET23	—	OEM175TFM with TFM1614NV Die	3/16"
YAE14N77FBOX		#6 - #8	0.31	0.96	0.77	0.29	YAE14N77F		YAE14N77FM		
YAE14N78FBOX		#8 - #10	0.36	1.01	0.79	0.20	YAE14N78F		YAE14N78FM		
YAE10N80FBOX*	12 - 10	#4 - #6	0.35	1.02	0.67	0.29	—	Non-Ratchet: Y10D, Y1022 Ratchet: MRE1022NV, MR833T1, M8ND with one of the following dies: N14HET25V1, N10ET9, N14HET15, N10ET23	—	OEM175TFM with TFM1210NV Die	3/8"
YAE10N81FBOX*		#6 - #8	0.35	1.02	0.67	0.29	—		—		
YAE10N82FBOX*		#10 - #9	0.37	1.02	0.65	0.29	—		—		
YAE10N83FBOX		1/4	0.50	1.20	0.70	0.29	—		—		

* Not UL Listed or CSA Certified.

† Not UL Listed; is CSA Certified.

** For UL Listed applications, consult BURNDY® factory.

▲ Only with #2-#20 AWG Wire

TYPE YHSA-F

HYDENT™ Heat Shrink Fork Tongue Terminals



For Copper Conductor; -55° through 110°C

Standard crimp terminals leave the wire exposed allowing in moisture or other contaminants which can result in corrosion. Corrosion reduces the amount of current the wire can carry safely. The integrity of the electrical system can be compromised when unsealed electrical connections are utilized. Heat shrink terminals provide a durable seal blocking out contaminants ensuring a better connection.

Features & Benefits

- Made from pure copper, annealed for maximum strength
- Color-coded, imprinted with wire size
- Serrated barrels offer maximum wire contact and tensile strength
- Electro-tin plated for corrosion resistance

NOTE: Field bending straight lugs to achieve an angular connection will void UL Listing / CSA Certifications and BURNDY will not be liable for the connection.

Catalog No. (100/bag)	Catalog No. (20/bag)	Stud Size	Conductor Size	Dimensions				Tongue Thickness	Installation Tooling	Wire Strip Length
				B	C	L	N			
YHSA18K6F	YHSA18K6FRK	4-6	22-18 AWG	0.22	0.25	1.17	0.32	0.04	MR22	5/16
YHSA18K8F	YHSA18K8FRK	6-8			0.32	1.17	0.32	0.04		
YHSA18K10F	YHSA18K10FRK	8-10			0.31	1.18	0.27	0.03		
YHSA14K6F	YHSA14K6FRK	4-6	16-14 AWG	0.22	0.25	1.17	0.30	0.04	MR22	5/16
YHSA14K8F	YHSA14K8FRK	6-8			0.34	1.17	0.30	0.04		
YHSA14K10F	YHSA14K10FRK	8-10			0.34	1.17	0.27	0.03		
—	YHSA14K14FRK	1/4			0.50	1.17	0.30	0.04		
YHSA10K6F	—	4-6	12-10 AWG	0.22	0.35	1.17	0.29	0.04	MR22	5/16
YHSA10K8F	YHSA10K8FRK	6-8			0.35	1.17	0.29	0.04		
YHSA10K10F	YHSA10K10FRK	8-10			0.37	1.16	0.27	0.04		
—	YHSA10K14FRK	1/4			0.50	1.17	0.30	0.04		

TYPE T-LF

HYLUG™

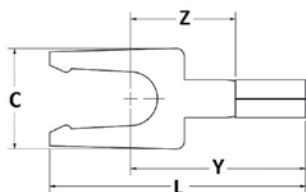

Type T-LF employs a locking fork tongue for fast installation and security.

Features & Benefits

- Locking fork tongue design allows fast installation - screw only has to be loosened for termination
- Internal configuration of the fork prevents the terminal from coming off the screw without applying a pulling force
- Locking fork is made from a copper alloy, permits many installations while maintaining proper spring retention of forks

NOTE: Field bending straight lugs to achieve an angular connection will void UL Listing / CSA Certifications and BURNDY will not be liable for the connection.

Catalog Number	Wire Range	Stud Size	C	L	Y	Z	Installation Tooling	Wire Strip Length
T166LF	22 - 16 AWG	#4 - #6	0.25	0.83	0.54	0.32	MRE1022B MR8G98 Y8MRB1 MR20 Y10D Y1022	9/32
T168LF		#6 - #8	0.31	0.83	0.57	0.32		
T1610LF		#8 - #10	0.31	0.83	0.63	0.32		
T146LF	16 - 14 AWG	#4 - #6	0.25	0.81	0.54	0.30	MRE1022B MR8G98 Y8MRB1 MR20 Y10D Y1022	9/32
T148LF		#6 - #8	0.30	0.83	0.57	0.30		
T1410LF		#8 - #10	0.32	0.83	0.63	0.30		
T106LF	12 - 10 AWG	#4 - #6	0.30	0.90	0.54	0.29	MRE1022B MR8G98 Y8MRB1 MR20 Y10D Y1022	11/32
T108LF		#6 - #8	0.33	0.90	0.57	0.29		
T1010LF		#8 - #10	0.35	0.90	0.63	0.29		

Small Terminals

Polyvinylchloride Insulated Locking Fork Tongue
Compression Terminals

TYPES TP-LF / BA-EL

600 Volts Max., 105° C Max.

VINYLUTM

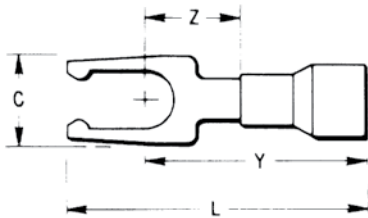

Type TP-LF is a variation of the Type TP design and employs a locking fork tongue for fast installation and security.

Features & Benefits

- Locking fork tongue design; allows fast installation; screw only has to be loosened for termination
- Internal configuration of the fork prevents the terminal from coming off the screw without applying a pulling force
- Locking fork is made from a copper alloy and permits many installations while maintaining proper spring retention of forks



NOTE: Field bending straight lugs to achieve an angular connection will void UL Listing / CSA Certifications and BURNDY will not be liable for the connection.

Catalog Number	Wire Range	Stud Size	Dimensions				Bulk Catalog Number .	Installation Tooling	Tape Mounted Catalog Number 2000/Reel	Tape Fed Installation Tooling	Wire Strip Length
			C	L. Max	Y Max.	Z Min.					
TP166LF	22 - 16 Max. Insul. Dia. Accom.: 0.15 Color Code: Red	#4 - #6	0.28	0.80	0.66	0.23	BA16EL6	Plier Type: Y1022	BA16EL6M	OEM175TFM with TFM2218NV Die	13/64
TP168LF		#6 - #8	0.31	0.86	0.69	0.26	BA16EL8		BA16EL8M		13/64
TP1610LF		#8 - #10	0.41	0.95	0.75	0.31	BA16EL10	Ratchet Tool: MRE1022NV MR8891 MR15	BA16EL10M		13/64
TP146LF	16 - 14 Max. Insul. Dia. Accom.: 0.18 Color Code: Blue	#4 - #6	0.28	0.80	0.66	0.23	BA14EL6	Plier Type: Y1022	BA14EL6M	OEM175TFM with TFM1614NV Die	13/64
TP148LF		#6 - #8	0.31	0.86	0.69	0.26	BA14EL8		BA14EL8M		13/64
TP1410LF		#8 - #10	0.41	0.95	0.75	0.31	BA14EL10	Ratchet Tool: MRE1022NV MR8891 MR15	BA14EL10M		13/64
TP106LF	12 - 10 Max. Insul. Dia. Accom.: 0.26 Color Code: Yellow	#4 - #6	0.28	0.95	0.81	0.26	BA10EL6	Plier Type: Y1022	* BA10EL6M	OEM175TFM with TFM1210NV Die	19/64
TP108LF		#6 - #8	0.31	0.98	0.81	0.26	BA10EL8		* BA10EL8M		19/64
TP1010LF		#8 - #10	0.41	1.07	0.87	0.31	BA10EL10	Ratchet Tool: MR8891 MR15	* BA10EL10M		19/64

• UL Listed and CSA Certified with MR8891 and MR15.

* 1000/Reel.

TYPE TN-LF

INSULUG™

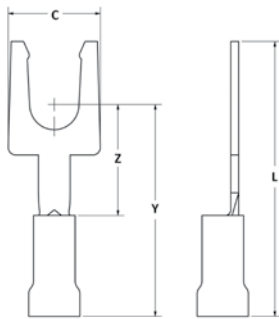

300 Volts Max., 105° C Max.

The Type TN-LF, nylon insulated fork tongue terminal has the same high quality as the TN. It is designed to meet the heavy-duty requirements of industrial and utility applications.

Used on both power and control circuits for wire sizes #26 AWG through #10 AWG. The TN-LF provides high dielectric strength and stability in oily conditions.

The TN-LF is identical to the TN with the addition of a fork tongue which allows installation without complete removal of its supporting screw.

Features & Benefits

- Locking fork tongue design allows fast installation - screw only has to be loosened for termination
- Internal configuration of the fork prevents the terminal from coming off the screw without applying a pulling force
- Locking fork is made from a copper alloy, permits many installations while maintaining proper spring retention of forks

NOTE: Field bending straight lugs to achieve an angular connection will void UL Listing / CSA Certifications and BURNDY will not be liable for the connection.

Catalog Number	Wire Range	Stud Size	Dimensions				Installation Tooling	Wire Strip Length
			C	L Max.	Y Max.	Z Min.		
TN186LF	22 - 18 Max. Insul. Dia. Accom: 0.145 Color Code: Red	4-6	0.25	0.95	0.66	0.32	MRE1022NV, MR883, Y10D, Y1022	7/32
TN188LF		6-8	0.31	0.95	0.69	0.32		
TN1810LF		8-10	0.31	0.95	0.75	0.32		
TN146LF	16 - 14 Max. Insul. Dia. Accom: 0.180 Color Code: Blue	4-6	0.25	0.93	0.66	0.30	MRE1022NV, MR883, Y10D, Y1022	7/32
TN148LF		6-8	0.30	0.95	0.69	0.30		
TN1410LF		8-10	0.32	0.95	0.75	0.30		
TN106LF	12 - 10 Max. Insul. Dia. Accom: 0.260 Color Code: Yellow	4-6	0.30	1.02	0.66	0.29	MRE1022NV, MR883, Y10D, Y1022	11/32
TN108LF		6-8	0.33	1.02	0.69	0.29		
TN1010LF		8-10	0.35	1.02	0.75	0.29		

TYPE YAE-N-LF

300 Volts Max., 105° C Max.

INSULUG™



The YAE-N-LF Locking Fork is nylon insulated with an insulation grip and accepts a 22-10 AWG wire. The spring-like tongue locks into place around the stud even when the mount screw is not tightened.

Features & Benefits

- Locking fork tongue design; allows fast installation; screw only has to be loosened for termination

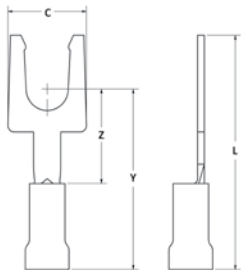

NOTE: Field bending straight lugs to achieve an angular connection will void UL Listing / CSA Certifications and BURNDY will not be liable for the connection.

Catalog Number	Wire Range	Stud Size	Dimensions				Installation Tooling	Wire Strip Length
			C	L Max.	Y Max.	Z Min.		
YAE18N104LFBOX	22 - 18	#4 - #6	0.25	0.95	0.66	0.32	MRE1022NV MR883 Y1022 Y10D	7/32
YAE18N105LFBOX		#6 - #8	0.31	0.95	0.69	0.32		
YAE18N106LFBOX		#8 - #10	0.31	0.95	0.75	0.32		
YAE14N107LFBOX	16 - 14	#4 - #6	0.25	0.93	0.66	0.30	MRE1022NV MR883 Y1022 Y10D	7/32
YAE14N108LFBOX		#6 - #8	0.30	0.95	0.69	0.30		
YAE14N109LFBOX		#8 - #10	0.32	0.95	0.75	0.30		
YAE10N110LFBOX	12 - 10	#4 - #6	0.30	1.02	0.81	0.29	MRE1022NV MR883 Y1022 Y10D	11/32
YAE10N111LFBOX		#6 - #8	0.33	1.02	0.81	0.29		
YAE10N112LFBOX		#8 - #10	0.35	1.02	0.87	0.29		

TYPE YHSA-K-LF

HYDENT™ Heat Shrink Fork



For Copper Conductor; -55° through 110°C

Standard crimp terminals leave the wire exposed allowing in moisture or other contaminants which can result in corrosion. Corrosion reduces the amount of current the wire can carry safely. The integrity of the electrical system can be compromised when unsealed electrical connections are utilized. Heat shrink terminals provide a durable seal blocking out contaminants ensuring a better connection.

Features & Benefits

- Made from copper, annealed for maximum strength
- Color-coded, imprinted with wire size
- Serrated barrels offer maximum wire contact and tensile strength
- Electro-tin plated for corrosion resistance

NOTE: Field bending straight lugs to achieve an angular connection will void UL Listing / CSA Certifications and BURNDY will not be liable for the connection.

Catalog Number	Wire Range	Stud Size	L	C	Y	Z	Installation Tooling	Wire Strip Length
YHSA18K6LF	22 - 18	#6	1.20	0.25	0.66	0.32	MR22	7/32"
YHSA18K8LF		#8	1.20	0.31	0.69	0.32		
YHSA18K10LF		#10	1.20	0.31	0.75	0.32		
YHSA14K6LF	16 - 14	#6	1.18	0.25	0.66	0.30	MR22	7/32"
YHSA14K8LF		#8	1.20	0.30	0.69	0.30		
YHSA14K10LF		#10	1.20	0.32	0.75	0.30		
YHSA10K6LF	12 - 10	#6	1.27	0.30	0.81	0.29	MR22	11/32"
YHSA10K8LF		#8	1.27	0.33	0.81	0.29		
YHSA10K10LF		#10	1.27	0.35	0.87	0.29		

Small Terminals

Polyvinylchloride Insulated Block Fork Tongue Compression Terminals

TYPE TP-BF

INSULUG™

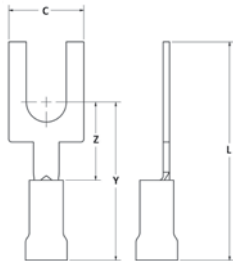

Type TP-BF terminals are made from pure electrolytic copper. Electro-tin plated for corrosion resistance and Polyvinylchloride insulated. Block spade design features squared off ends.

Features & Benefits

- Permits rapid, easy installation of the terminal under the screw head without complete removal of the screw

NOTE: Field bending straight lugs to achieve an angular connection will void UL Listing / CSA Certifications and BURNDY will not be liable for the connection.

Catalog Number	Wire Range	Stud Size	C	L	Y	Z	Installation Tooling	Wire Strip Length
TP166BF	22 - 16	#4 - #6	0.25	0.95	0.83	0.32	Y1022 MR8891 MR8G96 MR15 MRE1022NV	13/64
TP168BF		#6 - #8	0.31	0.95	0.79	0.32		
TP1610BF		#8 - #10	0.31	0.95	0.79	0.32		
TP146BF	16 - 14	#4 - #6	0.25	0.93	0.81	0.30	Y1022 MR8891 MR8G96 MR15 MRE1022NV	13/64
TP148BF		#6 - #8	0.30	0.95	0.80	0.30		
TP1410BF		#8 - #10	0.32	0.95	0.79	0.30		
TP106BF	12 - 10	#4 - #6	0.30	1.02	0.87	0.29	Y1022 MR8891 MR8G96 MR15 MRE1022NV	19/64
TP108BF		#6 - #8	0.33	1.02	0.86	0.29		
TP1010BF		#8 - #10	0.35	1.02	0.85	0.29		

TYPE TN-BF

HYDENT™

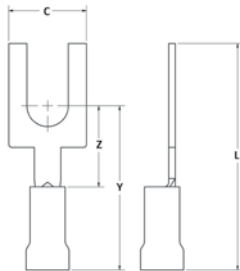

600 Volts Max., 105° C Max.

Type TN-BF terminals are made from pure electrolytic copper. Electro tin plated for corrosion resistance. Block spade design features squared-off ends.

Features & Benefits

- Permits rapid and easy installation of the terminal under the screw head without complete removal of the screw

NOTE: Field bending straight lugs to achieve an angular connection will void UL Listing / CSA Certifications and BURNDY will not be liable for the connection.

Catalog Number	Wire Range	Stud Size	C	L	Y	Z	Installation Tooling	Wire Strip Length
TN186BF	22 - 18	#4 - #6	0.25	0.95	0.83	0.32	MRE1022NV MR81A Y10D Y1022 M8ND with one of the following N14HET25V1, N10ET9, N14ET15, N10ET23	3/16"
TN188BF		#6 - #8	0.31	0.95	0.79	0.32		
TN1810BF		#8 - #10	0.31	0.95	0.79	0.32		
TN146BF	16 - 14	#4 - #6	0.25	0.93	0.81	0.30	MRE1022NV MR81A Y10D Y1022 M8ND with one of the following N14HET25V1, N10ET9, N14ET15, N10ET23	3/16"
TN148BF		#6 - #8	0.30	0.95	0.80	0.30		
TN1410BF		#8 - #10	0.32	0.95	0.79	0.30		
TN106BF	12 - 10	#4 - #6	0.30	1.02	0.87	0.29	MRE1022NV MR81A Y10D Y1022 M8ND with one of the following N14HET25V1, N10ET9, N14ET15, N10ET23	3/8"
TN108BF		#6 - #8	0.33	1.02	0.86	0.29		
TN1010BF		#8 - #10	0.35	1.02	0.85	0.29		

TYPE YAE-N-BF

600 Volts Max., 105° C Max.

INSULUG™



Type YAE-N-BF terminals are a block spade design featuring squared-off ends.

Features & Benefits

- Rapid, easy installation of terminal under the screw head without the complete removal of the screw

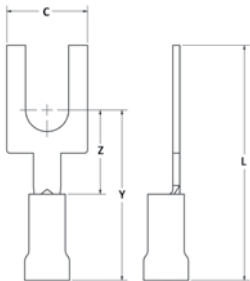

NOTE: Field bending straight lugs to achieve an angular connection will void UL Listing / CSA Certifications and BURNDY will not be liable for the connection.

Catalog Number	Wire Range	Stud Size	C	L	Y	Z	Installation Tooling	Wire Strip Length
YAE18N104BFBOX	22 - 18	#4 - #6	0.25	0.95	0.83	0.32	MRE1022NV, MR81A, MR833T1, Y10D, Y1022, M8ND with one of the following dies: N14HET25V1, N10ET9, N14ET15, N10ET23	3/16"
YAE18N105BFBOX	22 - 18	#6 - #8	0.31	0.95	0.79	0.32		
YAE18N106BFBOX	22 - 18	#8 - #10	0.31	0.95	0.79	0.32		
YAE14N107BFBOX	16 - 14	#4 - #6	0.25	0.93	0.81	0.30	MRE1022NV, MR81A, MR833T1, Y10D, Y1022, M8ND with one of the following dies: N14HET25V1, N10ET9, N14ET15, N10ET23	3/16"
YAE14N108BFBOX	16 - 14	#6 - #8	0.30	0.95	0.80	0.30		
YAE14N109BFBOX	16 - 14	#8 - #10	0.32	0.95	0.79	0.30		
YAE10N110BFBOX	12 - 10	#4 - #6	0.30	1.02	0.87	0.29	MRE1022NV, MR81A, MR833T1, Y10D, Y1022, M8ND with one of the following dies: N14HET25V1, N10ET9, N14ET15, N10ET23	3/8"
YAE10N111BFBOX	12 - 10	#6 - #8	0.33	1.02	0.86	0.29		
YAE10N112BFBOX	12 - 10	#8 - #10	0.35	1.02	0.85	0.29		

TYPE YHSA-K-BF

HYDENT™ Heat Shrink Block Fork



For Copper Conductor; -55° through 110°C

Standard crimp terminals leave the wire exposed allowing in moisture or other contaminants which can result in corrosion. Corrosion reduces the amount of current the wire can carry safely. The integrity of the electrical system can be compromised when unsealed electrical connections are utilized. Heat shrink terminals provide a durable seal blocking out contaminants ensuring a better connection.

Features & Benefits

- Made from copper, annealed for maximum strength
- Color-coded, imprinted with wire size
- Serrated barrels offer maximum wire contact and tensile strength
- Electro-tin plated for corrosion resistance

NOTE: Field bending straight lugs to achieve an angular connection will void UL Listing / CSA Certifications and BURNDY will not be liable for the connection.

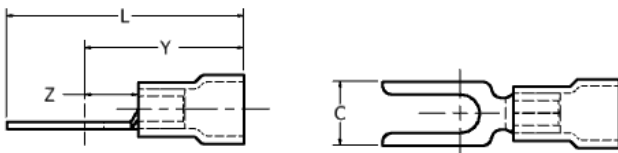

Catalog Number	Wire Range	Stud Size	C	L	Y	Z	Tongue Thickness	Installation Tooling	Wire Strip Length
YHSA18K6BF	22 - 18	#4 - #6	0.25	1.20	0.66	0.13	0.04	MR22	5/16"
YHSA18K8BF		#6 - #8	0.31	1.20	0.69	0.16	0.04	MR22	
YHSA18K10BF		#8 - #10	0.31	1.20	0.75	0.16	0.04	MR22	
YHSA14K6BF	16 - 14	#4 - #6	0.25	1.18	0.66	0.13	0.04	MR22	5/16"
YHSA14K8BF		#6 - #8	0.30	1.20	0.69	0.15	0.04	MR22	
YHSA14K10BF		#8 - #10	0.32	1.20	0.75	0.16	0.04	MR22	
YHSA10K10BF	12 - 10	#4 - #6	0.30	1.27	0.87	0.15	0.04	MR22	5/16"
YHSA10K6BF		#6 - #8	0.33	1.27	0.81	0.16	0.04	MR22	
YHSA10K8BF		#8 - #10	0.35	1.27	0.81	0.18	0.04	MR22	

TYPES YAV-H-F / YAV-Z

HYLUG™

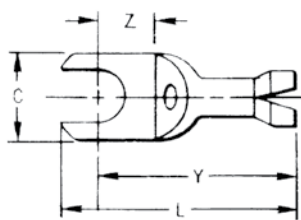
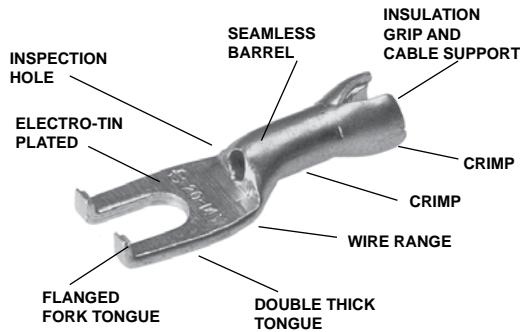

Fig .1

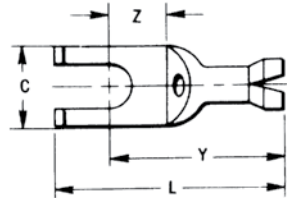

Fig .2

The type YAV-H-F HYLUG™ is a seamless heavy duty uninsulated compression fork tongue terminal with a shroud for an insulation grip and cable support. Manufactured from electrolytic copper tubing for use on copper commercial (code) cable, Type "AN" aircraft and extra flexible conductors.

The seamless tubing produces a double thick tongue while the seamless barrel design provides a very strong connector for very demanding applications that require highly reliable connections.

In addition to the benefits described for the YAV box series of connectors the YAVH-F Box and YAV-Z terminals provide the following benefits:

Features & Benefits

- Flanged fork permits installation of compression terminal under screw head without complete removal of the screw while also aiding to maintain the terminal on the stud should the screw loosen slightly



NOTE: Field bending straight lugs to achieve an angular connection will void UL Listing / CSA Certifications and BURNDY will not be liable for the connection.

Catalog Number	Fig.	Wire Range	Stud Size	Max. Insul. Dia. Accom.	C	L Max	Y Max	Z Min	Bulk Catalog #	Installation Tooling	Wire Strip Length
YAV18H6FBOX	1	22-18	4-6	0.120	0.25	0.89	0.80	0.19	YAV18H6F	Non-Ratchet: Y10D*, Y14MV, Y1022* Ratchet: MR8G98, MR89Q, Y8MRB1*, MR20, and M8ND with N14HT5 Die or N14HT	1/4"
YAV18H19FBOX	1		4-6	0.120	0.30	0.97	0.75	0.21	YAV18H19F		
YAV18H21FBOX	1		8-10	0.120	0.37	0.97	0.76	0.22	YAV18H21F		
YAV14Z5BOX	2	20-14	4-6	0.150	0.31	0.86	0.69	0.13	YAV14Z5		
YAV14H32FBOX	1		4-6	0.150	0.30	0.96	0.78	0.23	YAV14H32F		
YAV14H56FBOX	1		6-8	0.150	0.30	0.96	0.78	0.23	YAV14H56F		
YAV14H34FBOX	1		8-10	0.150	0.38	0.96	0.78	0.23	YAV14H34F		
YAV14HFBOX	1		8-10	0.150	0.31	0.92	0.78	0.23	YAV14HF		
YAV14Z6BOX	2	8-10	0.150	0.37	1.00	0.78	0.21	YAV14Z6			
YAV10HFBOX	1	12-10	8-10	0.192	0.38	1.07	0.78	0.24	YAV10HF	N10HT24	7/16"

* Crimps conductor crimp only.

TYPES TP-Z / BA-EZ

600 Volts Max., 105° C Max.

VINYLUG™

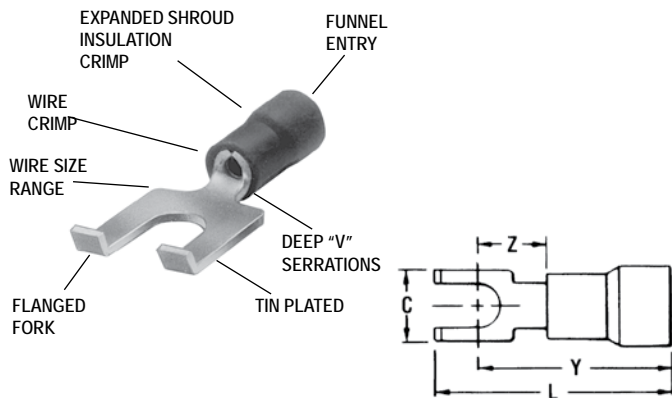

VINYLUG™ Type TP-Z is a variation of the Type TP and employs a flanged fork tongue for fast installation and security.

Features & Benefits

- Flange fork tongue design allows fast installation as screw only has to be loosened for termination
- The flanges on the end of the fork terminal aid in preventing a slightly loose terminal from becoming fully disconnected from the screw
- Flanges make re-securing a loose terminal easier



NOTE: Field bending straight lugs to achieve an angular connection will void UL Listing / CSA Certifications and BURNDY will not be liable for the connection.

Catalog Number	Wire Range	Stud Size	Dimensions				Bulk Catalog Number	Installation Tooling	Wire Strip Length
			C	Y Max.	Z Min.	L Max.			
TP162Z	22 - 16 Max. Insul. Dia. Accom.: 0.15 Color Code Red	#1 - #2	0.17	0.66	0.23	0.78	BA16EZ2	MRE1022NV, MR15, Y1022*, Y6NCB with J1022NC4	1/4"
TP166Z		#4 - #6	0.28	0.66	0.23	0.83	BA16EZ6		
TP168Z		#6 - #8	0.31	0.69	0.26	0.88	BA16EZ8		
TP1610Z		#8 - #10	0.41	0.75	0.31	0.96	BA16EZ10		
TP142Z	16 - 14 Max. Insul. Dia. Accom.: 0.18 Color Code: Blue	#1 - #2	0.17	0.66	0.23	0.78	BA14EZ2	MRE1022NV, MR15, Y1022*, Y6NCB with J1022NC4	1/4"
TP146Z		#4 - #6	0.28	0.66	0.23	0.83	BA14EZ6		
TP148Z		#6 - #8	0.31	0.69	0.26	0.88	BA14EZ8		
TP1410Z		#8 - #10	0.41	0.75	0.31	0.96	BA14EZ10		
TP106Z	12 - 10 Max. Insul. Dia. Accom.: 0.26 Color Code: Yellow	#4 - #6	0.28	0.81	0.26	0.99	—	MRE1022NV, MR15, Y6NCB with J1022NC4, M8ND* with N10ET23	11/32"
TP108Z		#6 - #8	0.31	0.81	0.26	1.01	BA10EZ8		
TP1010Z		#8 - #10	0.41	0.87	0.31	1.09	BA10EZ10		

* Tools highlighted with asterisks are NOT UL Listed when used with the connectors on this page.

Small Terminals

Nylon Insulated Flanged Fork,
Multi-Finger Insulation Grip

TYPE YAE-Z / YAE-Z BOX

600 Volts Max., 105° C Max.

INSULUG™

INSULUG™ Type YAE-Z is identical to Type YAE-N and employs a flanged fork tongue for faster installation while maintaining security if supporting screw becomes loose.

Features & Benefits

- Flanged fork permits rapid, easy installation of the terminal under the screw head without complete removal of the screw
- Additionally, it may not be removed with only a slight loosening of the screw

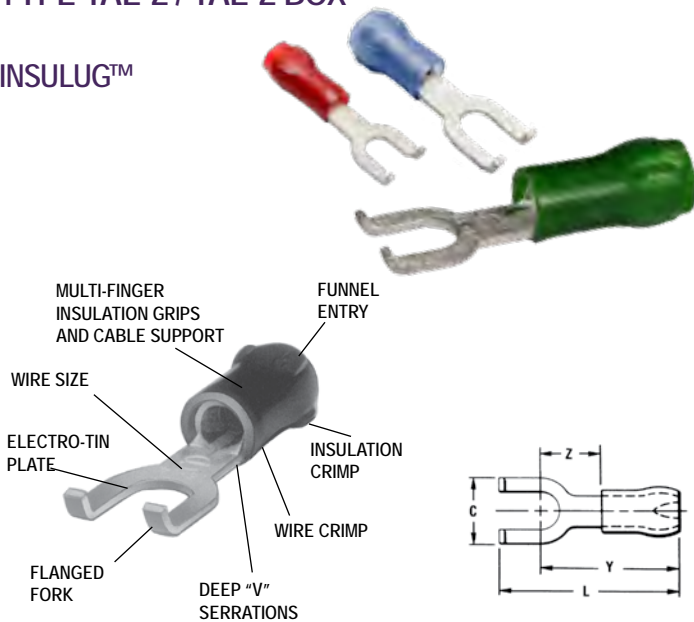

NOTE: Field bending straight lugs to achieve an angular connection will void UL Listing / CSA Certifications and BURNDY will not be liable for the connection.

Catalog Number	Wire Range	Stud Size	Dimensions				Bulk Catalog Number	Installation Tooling	Wire Strip Length
			C	Z Min.	Y Max.	L Max.			
YAE22Z1BOX *	26 - 20 Max. Insul. Dia.: .098" Sleeve Color: Amber	#2	0.18	0.21	0.63	0.75	YAE22Z1	MRE1022NV, MR833T1, M8ND with one of the following dies: N14HET15, N10ET9, N10ET23, N14HET25V1 Y10D, Y1022	5/32"
YAE22Z2BOX *		#4 - #6	0.28	0.24	0.67	0.83	YAE22Z2		
YAE22Z3BOX *		#6 - #8	0.31	0.28	0.70	0.92	YAE22Z3		
YAE18Z1BOX	22 - 16 Max. Insul. Dia. Accom.: .125" Color Code: Red	#2	0.18	0.21	0.70	0.83	YAE18Z1	MRE1022NV, MR833T1, M8ND with one of the following dies: N14HET15, N10ET9, N10ET23, N14HET25V1 Y10D, Y1022	3/16"
YAE18Z2BOX		#4 - #6	0.28	0.24	0.74	1.00	YAE18Z2		
YAE18Z3BOX		#6 - #8	0.31	0.28	0.77	1.00	YAE18Z3		
YAE18Z4BOX		#8 - #10	0.36	0.32	0.82	1.08	YAE18Z4		
YAE14Z2BOX	16 - 14 Max. Insul. Dia. Accom.: .156" Color Code: Blue	#4 - #6	0.28	0.25	0.74	0.90	YAE14Z2	MRE1022NV, MR833T1, M8ND with one of the following dies: N14HET15, N10ET9, N10ET23, N14HET25V1 Y10D, Y1022	3/16"
YAE14Z3BOX		#6 - #8	0.31	0.29	0.77	1.00	YAE14Z3		
YAE14Z4BOX		#8 - #10	0.36	0.33	0.82	1.08	YAE14Z4		
YAE12Z2BOX	14 - 12 Max. Insul. Dia. Accom.: .180" Color Code: Green	#4 - #6	0.28	0.25	0.88	1.04	YAE12Z2	MRE1022NV, MR833T1, M8ND with N12HET1 Y10D, Y1022	21/64"
YAE12Z3BOX		#6 - #8	0.31	0.30	0.93	1.16	YAE12Z3		
YAE12Z4BOX		#8 - #10	0.36	0.34	0.97	1.23	YAE12Z4		

* Not UL Listed

TYPE YSV-B

HYLINK™

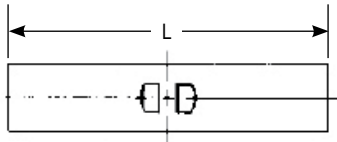

HYLINK™ Type YSV-B rolled splice connectors are used to splice stranded and solid copper conductors in virtually all heavy duty industrial and general purpose applications.

Features & Benefits

- Constructed of pure electrolytic copper to provide maximum conductivity, low resistance and ductility provided excellent crimp forming properties
- Electro-tin plated for durable long-lasting corrosion resistance

Catalog Number	Wire Range	L	Installation Tooling	Wire Strip Length
YSV18BBOX	22 - 18 AWG	0.62	Y10D Y1022 MRE1022B Y8MRB1 MR89Q MR8G98 MR20	1/4"
YSV14BBOX	16 - 14 AWG	0.64		1/4"
YSV10BBOX	12 - 10 AWG	0.75		5/16"

TYPE YSV

HYLINK™

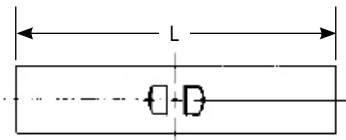
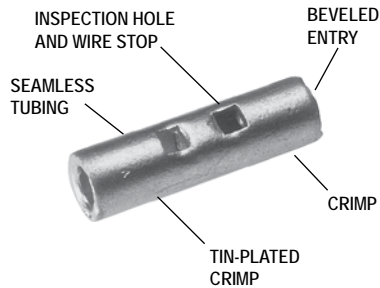

HYLINK™ Type YSV seamless splice connectors are used to splice stranded and solid copper conductors in virtually all heavy duty industrial and general purpose applications.

Features & Benefits

- Manufactured from seamless tubing; a high quality design with no seams to split
- Electrolytic copper provides maximum conductivity, low resistance and ductility for excellent crimp forming properties
- Electro-tin plated provides durable long lasting resistance to corrosion
- Positive center wire stops for proper depth of wire insertion
- Marked with wire size providing easy wire size identification
- The HYLINK™ splice connectors feature inspection holes providing easy visual inspection of proper wire insertion



Catalog Number	Wire Range AWG, AN, Aircraft	L	Bulk Catalog Number	Installation Tooling	Wire Strip Length
YSV18BOX	22 - 18	0.62	YSV18	Non-Ratchet: Y10D, Y1022 Ratchet: MRE1022B, MR20, Y8MRB1, MR89Q*, MR8G98	1/4"
YSV14BOX	20 - 14	0.64	YSV14	Non-Ratchet: Y10D, Y1022 Ratchet: MRE1022B, MR20, Y8MRB1, MR89Q*, MR8G98	1/4"
YSV10BOX	12 - 10	0.75	YSV10	Non-Ratchet: Y10D, Y1022 Ratchet: MRE1022B, MR20, Y8MRB1, MR89Q*, MR8G98	5/16"

* Remove stop plate

TYPE YSV-L

HYLINK™

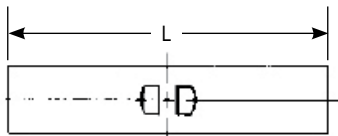
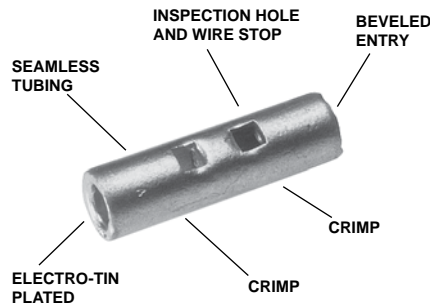

HYLINK™ Type YSV-L seamless splice connector is used to splice AN type aircraft cables plus commercial stranded and solid AWG conductors. Suitable for aircraft, light duty industrial and general purpose applications.

Features & Benefits

- Manufactured from seamless tubing; A high quality design with no seams to split
- Electrolytic copper provides maximum conductivity, low resistance and ductility for excellent crimp forming properties
- Electro-tin plated to provide durable long lasting resistance to corrosion
- Wire stop provides proper depth of wire insertion
- Marked with wire size provides easy wire size identification
- The HYLINK™ splice connectors have inspection holes to provide easy visual inspection for proper wire insertion



Catalog Number	Wire Range Aircraft-AN Comm'l-AWG Str. & Sol.	Dimensions L	Bulk Catalog Number	Installation Tooling			Wire Strip Length	
				Ratchet	HYTOOL™ **	• 35 Series		
						Nest		Indenter
YSV8CLBOX	8 AWG	1.00	YSV8CL	MR89Q, Y8MRB1, Y1MRTC	MY28 (for Type AH Aircraft Cable); All others: MY293, MY2911 1 Crimp	UV8L	Y34PL	7/16"
YSV6CLBOX	6 AWG	1.12	YSV6CL	Y1MRTC, MR4C		UV6L	Y34PLA	5/8"
YSV4CLBOX	4 AWG	1.12	YSV4CL	Y1MRTC, MR4C		UV4L	Y34PLA	5/8"
YSV2CLBOX	2 AWG	1.41	YSV2CL	Y1MRTC		UV2L	Y34PLA	5/8"
YSV1CLBOX	1 AWG	1.46	YSV1CL	—		UV1L	Y34PLA	5/8"
YSV25LBOX	1/0 AWG	1.53	YSV25L	—		UV25L	Y34PA	11/16"
YSV26LBOX	2/0 AWG	1.78	YSV26L	—		UV26L	Y34PA	13/16"
YSV27LBOX	3/0 AWG	1.81	YSV27L	—		UV27L	Y34PA	13/16"
YSV28LBOX	4/0 AWG	1.94	YSV28L	—		UV28L	Y34PA	7/8"

* Remove stop plate

• Use Y35P3 Indenter Adaptor.

** Bench Mount Adaptor (Catalog Number: BMYBCHMT) is available for MY Series HYTOOL™

TYPE YSV-H

HYLINK™

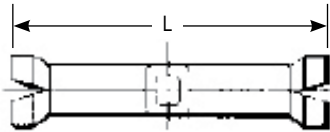
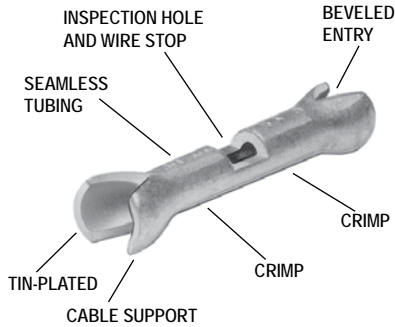

The Type YSV-H HYLINK™ seamless splice connectors have the added benefit of an insulation support and cable strain relief.

Features & Benefits

- Manufactured from seamless tubing
- High quality design with no seams to split
- Electrolytic copper provides maximum conductivity, low resistance, and ductility for excellent crimp forming properties
- Electro-tin plated to provide durable long lasting resistance to corrosion
- Positive center wire stops provide proper depth of wire insertion
- Marked with wire size for easy wire size identification
- HYLINK™ splice connectors have inspection holes for easy visual inspection of proper wire insertion



Catalog Number	Wire Range AWG, AN, Aircraft	L	Bulk Catalog Number	Installation Tooling	Wire Strip Length
YSV18HBOX	22 - 18	0.89	YSV18H	MRE1022B MR89Q* MR8G98	1/4"
YSV14HBOX	20 - 14	0.94	YSV14H		1/4"
YSV10HBOX	12 - 10	1.06	YSV10H		5/16"

* Remove stop plate.

TYPE SP

VINYLINK™

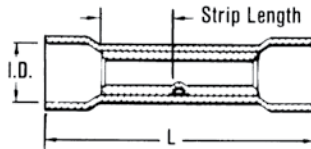
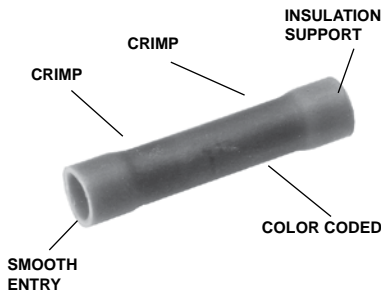

600 Volts Max., 105° C Max.

Type SP VINYLINK™ butt splices are PVC insulated, seamless and designed to accommodate a broad range of 600 volt cables.

Features & Benefits

- Manufactured from seamless electrolytic copper tubing to provide maximum conductivity and tensile strength in a high quality design with no seams to split
- Funnel entry for easy wire insertion
- Electro-tin plated providing durable, long lasting resistance to corrosion
- Expanded insulation support to lower inventory requirements
- Red wire range of 22-16 also assists to lower inventory requirements
- Vinyl insulation provides an economical means of providing high dielectric values and cable insulation support



Catalog Number	Wire Range	Color Code	Bulk Catalog Number	Dimensions (Inches)		Installation Tooling	Wire Strip Length
				L Max.	Max Insul. Dia		
SP16	22 - 16	Red	BS16	1.00	0.15	Non-Ratchet: Y1022 Ratchet: MRE1022NV MR8G98 MR15 MR8891	1/4"
SP14	16 - 14	Blue	BS14	1.00	0.18	Non-Ratchet: Y1022 Ratchet: MRE1022NV MR8G98 MR15 MR8891	1/4"
SP10	12 - 10	Yellow	BS10	1.23	0.26	Non-Ratchet: Y1022 Ratchet: MRE1022NV MR8G98 MR15 MR8891	21/64"

TYPE SN

INSULINK™

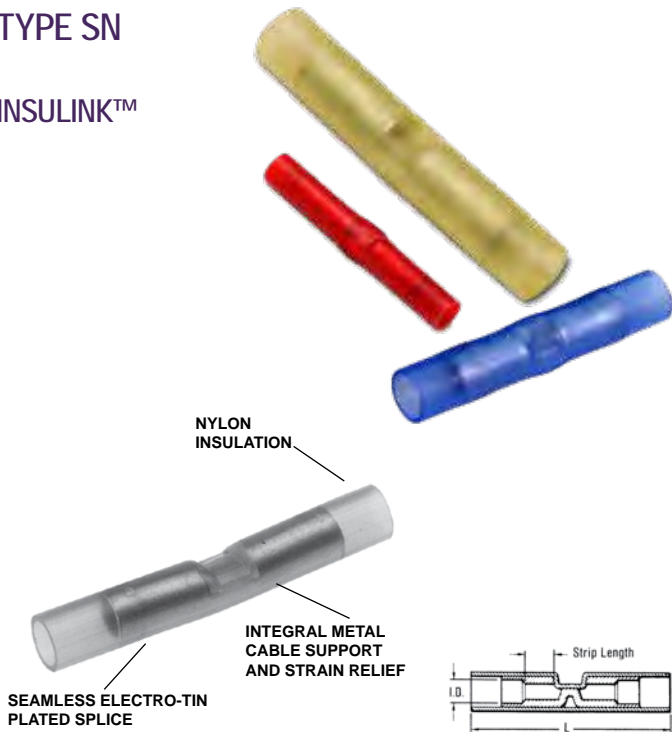

NYLON
INSULATION

INTEGRAL METAL
CABLE SUPPORT
AND STRAIN RELIEF

SEAMLESS ELECTRO-TIN
PLATED SPLICE

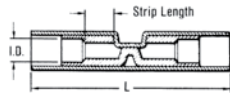

600 Volts Max., 105° C Max.

The Type SN INSULINK™ is a high quality nylon-insulated butt splice designed to meet heavy duty application requirements.

Meets the functional requirements of SAE-AS7928 and conforms to the requirements of NAS1388.

Features & Benefits

- Manufactured from seamless tubing — a high quality design with no seams to split
- Pure electrolytic copper for maximum conductivity, low resistance and ductility for excellent crimp forming properties
- Electro-tin plated provides durable long-lasting resistance to corrosion
- Positive center wire stops for proper depth of wire insertion
- Color-coded in red, blue and yellow — provides easy wire size identification
- Manufactured from one-piece tin-plated seamless copper tubing with an integral barrel/insulation grip — provides maximum tensile strength, plus excellent cable support and strain relief and eliminates failures due to vibration
- Smooth funnel entry provides easy wire insertion
- Window position locator for full cycle ratchet tool crimp — provides proper tool/connector alignment for correct crimp
- Nylon insulation offers high dielectric strength and stability in oily environmental conditions — maintains a high quality connection in demanding applications
- The nylon is locked into position; the connector will not move

Catalog Number	Wire Range	Color Code	Bulk Catalog Number	L Max.	Max Insul Dia	Installation Tooling	Wire Strip Length
SN18	22 - 18	Red	YSE18HN	1.25	0.12	Plier: Y10D Y1022 Ratchet: MRE1022NV MR883 MR18	15/64"
SN14	16 - 14	Blue	YSE14HN	1.25	0.15	Plier: Y10D Y1022 Ratchet: MRE1022NV MR883 MR18	7/32"
SN10	12 - 10	Yellow	YSE10HN	1.64	0.22	Plier: Y10D Y1022 Ratchet: MRE1022NV MR883 MR18	3/8"

TYPE SN-B

INSULINK™



600 Volts Max., 105° C Max.

The Type SN-B INSULINK™ is a high quality nylon-insulated butt splice.

Features & Benefits

- Tin plated copper brazed butt seam
- Smooth funnel entry provides easy wire insertion
- Nylon insulation offers high dielectric strength and stability

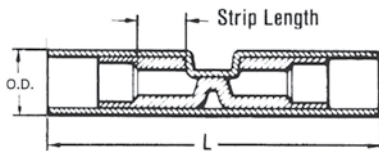

Catalog Number	Wire Range	Color Code	L	OD	Installation Tooling	Wire Strip Length
SN18B	22 - 18 AWG	Red	1.25	0.12	Y10D Y1022 MRE1022NV MR885	15/64"
SN14B	16 - 14 AWG	Blue	1.25	0.15	Y10D Y1022 MRE1022NV MR885	7/32"
SN10B	12 - 10 AWG	Yellow	1.64	0.22	Y10D Y1022 MRE1022NV MR885	3/8"

Small Terminals

Nylon Insulated Splices for Aircraft and Commercial Flex Cables

TYPES YSE / YSE-H BOX

600 Volts Max., 105° C Max.

INSULINK™



Types YSE and YSE-H INSULINK™ splices are high quality nylon insulated splices designed for splicing aircraft and commercial flexible cables.

Features & Benefits

- Manufactured from tin plated, seamless electrolytic copper tubing with integral barrel/insulation grip — providing maximum conductivity and tensile strength along with excellent cable support and strain relief
- Split heavy wall insulation grip for stronger insulation grip and strain relief
- Smooth funnel entry for easy wire insertion
- Transparent nylon insulation for easy wire inspection

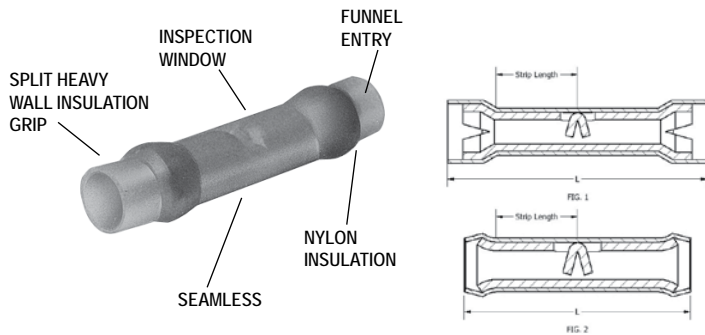

Catalog Number	Figure	Wire Range (Code, AWG, Aircraft, AN)	Color Code	Bulk Catalog Number	L Max.	Max Dia. Insul.	Installation Tooling	Wire Strip Length
YSE18HBOX	1	22 - 18	Red	YSE18H	1.22	0.12	Y10D Y1022 Ratchet: MRE1022NV MR833T1	9/32"
YSE14HBOX	1	16 - 14	Blue	YSE14H	1.36	0.15	Y10D Y1022 Ratchet: MRE1022NV MR833T1	11/32"
YSE10BOX	2	12 - 10	Yellow	YSE10	1.15	0.21	Y10D Y1022 Ratchet: MRE1022NV MR833T1	23/64"

TYPE YSE-HHS

HYDENT™

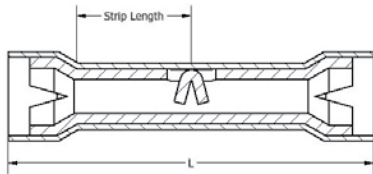

For Copper Conductor; -55° through 110°C

Heat shrink butt splices are color-coded to industry wire standard range. Heat shrink protects against corrosion.

Features & Benefits

- Manufactured from tin plated, seamless electrolytic copper tubing with integral barrel for maximum conductivity and tensile strength, plus excellent cable support and strain relief
- Smooth funnel entry provides easy wire insertion
- Transparent heat shrink insulation provides waterproofing and weather resistance

Catalog Number	Wire Range	L	W	Installation Tooling	Wire Strip Length
YSE18HHS	18 - 22	1.50	0.17	Y10D, Y1022 MR833T1	9/32"
YSE14HHS	16 - 14	1.50	0.20	Y10D, Y1022 MR833T1	11/32"
YSE10HHS	12 - 10	1.60	0.25	Y10D, Y1022 MR833T1	23/64"

TYPE YHSS

HYDENT™



For Copper Conductor; -55° through 110°C

Standard crimp terminals leave the wire exposed, allowing in moisture or other contaminants which can result in corrosion. Corrosion reduces the amount of current the wire can carry safely. The integrity of the electrical system can be compromised when unsealed electrical connections are utilized. Heat shrink terminals provide a durable seal blocking out contaminants ensuring a better connection.

Features & Benefits

- Made from pure copper, annealed for maximum strength
- Color-coded, imprinted with wire size
- Serrated barrels offer maximum wire contact and tensile strength
- Electro-tin plated for corrosion resistance

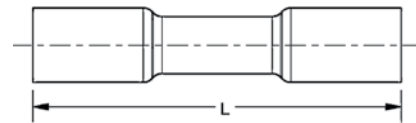

Catalog Number (100/bag)	Catalog No. (20/bag)	Conductor Size	L
YHSS18	YHSS18RK	22 - 18 AWG	1.50"
YHSS14	YHSS14RK	16 - 14 AWG	1.50"
YHSS10	YHSS10RK	12 - 10 AWG	1.60"

Recommended Tooling MR22

TYPE YSES-K

INSULINK™

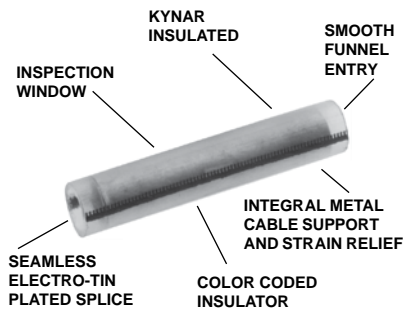

Polyvinylidene Fluoride (PVF2) Insulated
200 Megarads; 60°C through 150°C; 600 Volts

Type YSES-K radiation resistant insulated splices are suitable for class 1E applications plus non critical nuclear associated applications. The splice is manufactured from pure electrolytic copper seamless tubing which eliminates potentially splitting of seams. A color code stripe is used for wire size identification and a window is provided for inspection of proper wire insertion.

Features & Benefits

- These insulated splices are suitable for class 1E applications
- Pure electrolytic copper seamless tubing eliminates potential splitting of seams
- Color coded stripe identifies wire size
- Window is provided for inspection of proper wire insertion
- Suitable for 200 Megarads Rated 60°C through 150°C; 600 Volts

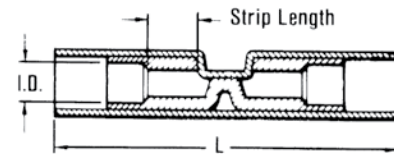

Catalog Number	Wire Range	Color Stripe	Dimension Max. Insul. Dia. Accom.	L Max.	Installation Tooling	Wire Strip Length
YSES18K	22-18	Red	0.11	1.00	Ratchet Tool: MR10G8 Red Groove Calibration Gauge: PG3731 Crimp ID Mark: (1) Small Dot	3/16"
YSES14K	16-14	Blue	0.15	1.00	Ratchet Tool: MR10G8 Blue Groove Calibration Gauge: PG3711 Crimp ID Mark: (2) Small Dots	3/16"
YSES10K	12-10	Yellow	0.21	1.38	Ratchet Tool: MR10G8 Yellow Groove Calibration Gauge: PG3721 Crimp ID Mark: (1) Large Dot	7/16"

TYPE YSM

HYLINK™

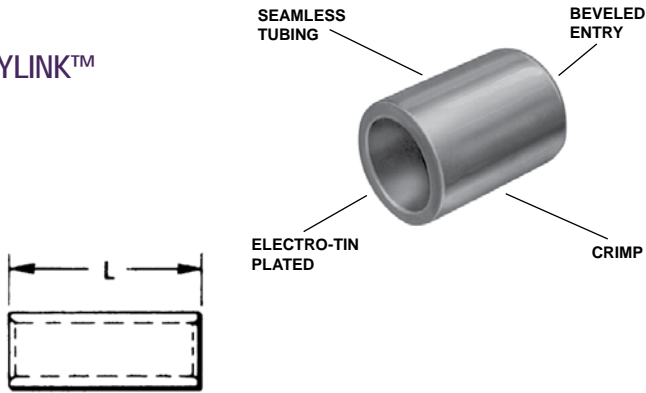

HYLINK™ Type YSM seamless parallel splice connector permits wires to be laid parallel inside the connector and spliced together with the BURNDY family of HYTOOL™ installation tooling. Each YSM connector accommodates a wide combination of round, square, and rectangular copper conductors that have a total combined circular mil area listed in the table below. The conductors to be spliced must physically fit within the splice without being forced.

Features & Benefits

- Seamless tubing
- Beveled barrel for ease of wire entry
- Tin plated
- Parallel design results in only one crimp necessary
- Uninsulated barrel provides an economical termination solution when insulation is not specified

Catalog Number	Circular Mil. Range	Dim. L	Installation Tooling						Wire Strip Length
			Ratchet	Mechanical HYTOOL™	Y29 Series		35, 750 Series		
					Nest	Indenter	Nest	Indenter	
YSM18	300 - 1,909	0.25	MR89Q*	—	—	—	—	—	5/16
YSM14	477 - 4,107	0.25	Y14MRQ Y8MRB1	—	—	—	—	—	5/16
YSM10	4,107 - 10,380	0.36	MR89Q* MR4CQ Y10MRQ Y8MRB1	—	—	—	—	—	7/16
YSM8C	6,088 - 16,864	0.41	Y2MR MR4CQ MR89Q*	MY2911 or MY28 (1) Crimp	DV8L-1	Y29PQ	UV8L	Y29PQ	1/2
YSM6C	10,380 - 26,813	0.44	Y2MR		DV6L	Y29PQ	UV6L	Y29PQ	1/2
YSM4C	26,813 - 42,613	0.50	MR4CQ		DV4L	Y29PQ	UV4L	Y29PQ	9/16
YSM2C	42,613 - 66,832	0.62	Y2MR		DV2L	Y29PQ	UV2L	Y29PQ	11/16
YSM1C	66,832 - 81,807	0.62	—		DV1L	Y29PQ	UV1L	Y29PQ	11/16
YSM25	81,807 - 104,110	0.69	—		DV25L	Y29PQ6	UV25L	Y29PQ6	3/4
YSM26	104,110 - 133,650	0.81	—		DV26L	Y29PQ6	UV26L	Y29PQ6	7/8
YSM27	133,650 - 167,332	0.81	—		DV27L	Y29PQ6	UV27L	Y29PQ6	7/8
YSM28	167,332 - 211,954	0.88	—		DV28L	Y29PQ6	UV28L	Y29PQ6	5/16

Wire Size	Area Cir. Mils.	Solid Wire Dia. (In.)	Concentric Str. Max. Dia. (In.)
30	100.5	0.010003	0.012
29	126.7	0.01126	—
28	159.8	0.01264	0.015
27	201.5	0.01420	—
26	254.1	0.01594	0.019
25	320.4	0.01790	—
24	404.0	0.02010	0.024
23	509.5	0.02257	—
22	642.4	0.02535	0.030
21	810.1	0.02845	—
20	1022	0.03196	0.038
19	1288	0.03589	—
18	1624	0.04030	0.0460
17	2048	0.04526	—
16	2583	0.05082	0.0585
15	3257	0.05707	—
14	4107	0.06408	0.0735

Wire Size	Area Cir. Mils.	Solid Wire Dia. (In.)	Concentric Str. Max. Dia. (In.)	Flex. Bunch or Rope Lay Dia. (In Approx.)
13	5178	0.07196	—	—
12	6530	0.08081	0.0931	0.101
11	8234	0.09074	—	—
10	10380	0.1019	0.117	0.126
9	13090	0.1144	0.132	0.146
8	16510	0.1285	0.148	0.157–0.162
7	20820	0.1433	0.166	0.179–0.196
6	26250	0.1620	0.186	0.207–0.215
5	33100	0.1819	0.209	0.235–0.240
4	41740	0.2043	0.235	0.263–0.269
3	52640	0.2294	0.264	0.219–0.305
2	66370	0.2576	0.297	0.319–0.337
1	83690	0.2893	0.333	0.367–0.376
1/0	105500	0.3249	0.374	0.441–0.423
2/0	133100	0.3648	0.420	0.500–0.508
3/0	167800	0.4096	0.472	0.549–0.576
4/0	211600	0.4600	0.530	0.613–0.645

TYPE YSCM

HYLINK™



Type YSCM HYLINK™ seamless parallel splice connectors permit stranded wires to be laid parallel inside the connector and spliced together with BURNDY® compression tools. Each YSCM connector accommodates a wide range of conductors and is color-coded to ensure proper tool and die match. YSCM connectors are cULus Listed Wire Connectors per UL 486A/B. Additionally, they are cULus Listed for Grounding and Bonding per UL 467 and rated for direct burial in Earth and Concrete.

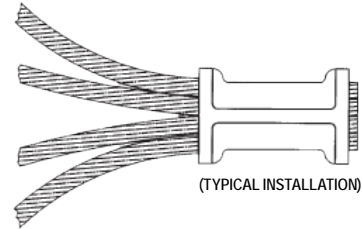

Catalog Number	Conductor Range Cable†		Dimensions Inches [mm]		Color Code	Die Index	Recommended Installation Tooling		Wire Stript Length
	Circular Mils		L ±.03	O.D. ±.01			OUR840, 500, 600 Series	35, 750 Series	
	Min.	Max.							
YSCM17	13,060	16,910	0.5 [13]	0.27 [7]	Red	49	X8CRT, W8CRT	U8CRT	11/16
YSCM27	16,910	26,890	0.5 [13]	0.31 [8]	Blue	7	X5CRT, W5CRT	U5CRT	11/16
YSCM42	29,970	41,520	0.5 [13]	0.38 [10]	Gray	8	X4CRT, W4CRT	U4CRT	11/16
YSCM66	42,750	66,040	0.62 [16]	0.47 [12]	Brown	10	X2CRT, W2CRT	U2CRT	3/4
YSCM80	67,980	80,020	0.62 [16]	0.52 [13]	Green	11	X1CRT1, W1CRT1	U1CRT1	3/4
YSCM104	82,870	103,630	0.69 [18]	0.57 [14]	Pink	12	X25RT, W25RT	U25RT	15/16
YSCM133	104,960	133,220	0.81 [21]	0.64 [16]	Black	13	X26RT, W26RT	U26RT	1-1/16
YSCM167	134,340	166,560	0.81 [21]	0.7 [18]	Orange	14	X27RT, W27RT	U27RT	1-1/16
YSCM212	167,380	211,820	0.88 [22]	0.78 [20]	Purple	15	X28RT, W28RT	U28RT	1-1/16
YSCM231	230,800	230,800	1.05 [27]	0.8 [21]	Yellow	16	X29RT, W29RT, *	U29RT	1-1/16

Notes:

Material: Copper per ASTM B75.
 Finish: Tin plated. For nickel plating, add suffix "NK" to the Catalog Number.
 Dimensions in brackets [] are in millimeters rounded off to the nearest millimeter, unless otherwise noted, and are for reference only.
 †Recommended strip length. Strip length dependent on size, no. of wires and insulation thickness.
 ‡Refer to Circular Mil Table per ASTM B8 for total Class B Circular Mil calculations.
 *YSCM231 can also be installed with MY29-3 and retain Listings.

Add the circular mils of the wires you wish to splice; that sum would be used to determine the correct splice using the Min/Max columns on the table above.

The tables to the right are for reference only.

Size		ASTM Strandings	
Circular Mils	AWG	Class	Cable Diameter (in)
1,022	20	B	0.036
1,624	18	B	0.045
2,583	16	B	0.057
4,107	14	B	0.072
6,530	12	B	0.091
10,380	10	B	0.116
13,090	9	B	0.130
16,510	8	B	0.146
20,820	7	B	0.164
26,250	6	B	0.184
33,100	5	B	0.206
41,740	4	AA	0.254
41,740	4	B & A	0.232
52,630	3	AA	0.285
52,630	3	B & A	0.260

Size		ASTM Strandings	
Circular Mils	AWG	Class	Cable Diameter (in)
66,370	2	AA	0.320
66,370	2	B & A	0.292
83,690	1	AA	0.360
83,690	1	A	0.328
83,690	1	B	0.332
105,500	1/0	A & A	0.368
105,500	1/0	-	0.390
105,500	1/0	B	0.373
133,100	2/0	A & A	0.414
133,100	2/0	-	0.438
133,100	2/0	B	0.419
167,800	3/0	A & A	0.464
167,800	3/0	-	0.492
167,800	3/0	B	0.470
211,600	4/0	A & A	0.522
211,600	4/0	-	0.522
211,600	4/0	B	0.528

TYPES YSV / YRV-L

HYREDUCER™



The HYREDUCER™ is a connector for splicing two different size wires. The larger conductor is inserted first and butts against the center of the connector where the smaller barrel begins. Constructed of pure electrolytic copper tubing for maximum conductivity, tin plated to resist corrosion, the HYREDUCER™ accommodates a wide range of cable sizes.

Dimensional information may be found in Table 1.
Table 2 is a comprehensive tooling index for these connectors.

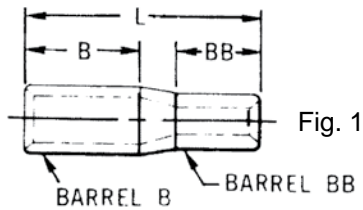

Fig. 1

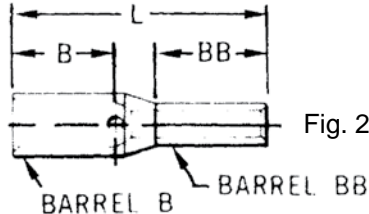

Fig. 2

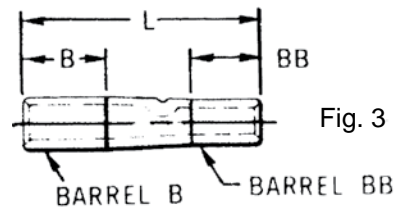

Fig. 3

Catalog Number	Wire Range AWG, AN, Aircraft	Fig. No.	B Barrel*			BB Barrel*			L Max.
			Wire Size	B Dim.	Tool Index	Wire Size	BB Dim.	Tool Index	
YSV1418	22 - 14	1	20 - 14	0.27	1	22 - 18	0.27	2	0.60
YSV1214G1	16 - 12	2	12	0.31	4	16 - 14	0.27	1	0.81
YSV1014G2	20 - 10	2	12 - 10	0.31	4	20 - 14	0.27	1	0.77
YRV8CV14L	20 - 8	3	8	0.44	5	20 - 14	0.39	1	1.16
YRV8CV10L	12 - 8	3	8	0.44	5	12 - 10	0.53	4	1.15
YRV6CV10L	12 - 6	3	6	0.50	6	12 - 10	0.53	4	1.25
YRV6CV8CL	8 - 6	3	6	0.50	6	8	0.53	5	1.18
YRV4CV6CL	6 - 4	3	4	0.50	7	6	0.54	6	1.24
YRV2CV6CL	6 - 2	3	2	0.62	8	6	0.51	6	1.60

* B and BB dimensions are wire strip lengths.

TOOL INDEX

Index Number	Hand Tools	Tools With Dies	
		Y29 Series	
1	MR8G98	—	
2	Y8MRB1	—	
	MR89Q†	—	
4	MR20	—	
5	Y8MRB1 MY28 MR4C Y1MRTC	Nest	Indentor
		DV8L1*	Y29PL
6	MY28 MR4C Y1MRTC	DV6L	Y29PL
7	MY28 MR4C Y1MRTC	DV4L	Y29PL
8	Y1MRTC MY28	DV2L	Y29PL

* For aircraft applications (flexible cables).

TYPE Q-M

FINGRIP™ Non-Insulated Male Quick Disconnects

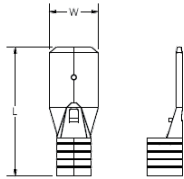

Non insulated quick disconnects allow for quickly connecting or disconnecting a terminal. The front end of the terminal has a male-type blade which slides into a female-type receptacle.

Features & Benefits

- Butted seam
- Chamfered barrel opening for quick and easy wire insertion
- Mates with dimpled female socket detent for a firm grip

Catalog Number	Wire Range	NEMA Tab Size	L	W	Installation Tool	Wire Strip Length	Bulk Catalog Number
Q18M11X02D	18 - 22	0.110 X 0.020	0.66	0.110	MRE1022B MR20 Y10D Y1022	3/8"	—
Q18M18X02D		0.187 X 0.020	0.66	0.187			Q18M18X02B
Q18M25X03D		0.250 X 0.032	0.66	0.250			Q18M25X03B
Q14M18X02D	14 - 16	0.187 X 0.020	0.66	0.187			Q14M18X02B
Q14M25X03D		0.250 X 0.032	0.66	0.250			Q14M25X03B
Q10M25X03D	12 - 10	0.250 X 0.032	0.66	0.250			—

TYPE Q-F

FINGRIP™ Non-Insulated Female Quick Disconnects

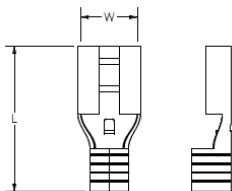

Non-insulated quick disconnects allow for quickly connecting or disconnecting a terminal. The front end of the terminal has a female-type receptacle which slides onto a male-type blade.

Features & Benefits

- Butted seam
- Chamfered barrel opening for quick and easy wire insertion
- Dimpled female socket detent ensure firm grip

Catalog Number	Wire Range	NEMA Tab Size	L	W	Installation Tooling	Wire Strip Length	Bulk Catalog Number
Q18F11X02D	18 - 22	0.110 x 0.020	0.66	0.110	MRE1022B Y10D MR20	3/8"	—
Q18F18X02D		0.187 x 0.020		0.187			Q18F18X02B
Q18F25X03D		0.250 x 0.032		0.250			Q18F25X03B
Q14F11X02D	14 - 16	0.110 x 0.020		0.110			Q14F11X02B
Q14F18X02D		0.187 x 0.020		0.187			Q14F18X02B
Q14F25X03D		0.250 x 0.032		0.250			Q14F25X03B
Q10F11X02D	12 - 10	0.110 x 0.020	0.110	—			
Q10F18X02D		0.187 x 0.020	0.187	—			
Q10F25X03D		0.250 X 0.032	0.250	Q10F25X03B			

Small Terminals

Vinyl Insulated Tin-Plated Brass Male / Female
Compression Quick Disconnects

TYPE QP-M

FINGRIP™ Vinyl Insulated
Male Quick Disconnects

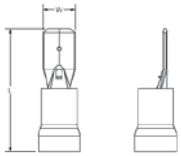

600 Volts Max., 105° C Max.

Vinyl insulated quick disconnects allow for quickly connecting or disconnecting a terminal. The front end of the terminal has a male-type blade which slides into a female-type receptacle.

Features & Benefits

- Butted seam
- Funnel entry barrel opening for quick and easy wire insertion
- Mates with dimpled female socket detent for a firm grip

Catalog Number	Wire Range	NEMA Tab Size	L	W	Installation Tool	Wire Strip Length	Bulk Catalog Number
QP18M11X02D	18 - 22	0.11 X 0.02	0.76	0.11	MRE1022NV Y1022 Y10D	3/8"	—
QP18M18X02D		0.19 X 0.02	0.76	0.19			QP18M18X02B
QP18M25X03D		0.25 X 0.03	0.84	0.25			QP18M25X03B
QP14M11X02D	14 - 16	0.11 X 0.02	0.76	0.11	MRE1022NV Y1022 Y10D	3/8"	—
QP14M18X02D		0.19 X 0.02	0.76	0.19			QP14M18X02B
QP14M25X03D		0.25 X 0.03	0.84	0.25			QP14M25X03B
QP10M25X03D	12 - 10	0.25 X 0.03	0.93	0.25	MRE1022NV Y1022 Y10D	3/8"	—

TYPE QP-F

FINGRIP™ Vinyl Insulated
Female Quick Disconnects

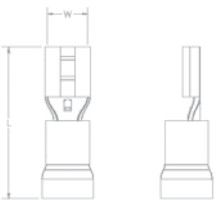

600 Volts Max., 105° C Max.

Vinyl insulated quick disconnects allow for quickly connecting or disconnecting a terminal. The front end of the terminal has a female-type receptacle which slides onto a male-type blade.

Features & Benefits

- Butted seam
- Insulated connectors eliminate the need for post installation insulation
- Funnel entry barrel opening for quick and easy wire insertion
- Dimpled female socket detent ensure firm grip

Catalog Number	Wire Range	NEMA Tab Size	L	W	Bulk Catalog Number	Installation Tool	Wire Strip Length
QP18F11X02D	16 - 22	0.11 X 0.02	0.75	0.11	—	MRE1022NV Y10D	3/8"
QP18F18X02D		0.19 X 0.02	0.79	0.22	QP18F18X02B		
QP18F25X03D		0.25 X 0.03	0.87	0.29	QP18F25X03B		
QP14F11X02D	14 - 16	0.11 X 0.02	0.75	0.11	—	MRE1022NV Y10D	3/8"
QP14F18X02D		0.19 X 0.02	0.79	0.23	QP14F18X02B		
QP14F25X03D		0.25 X 0.03	0.87	0.29	QP14F25X03B		
QP10F18X02D*	10 - 12	0.19 X 0.02	0.98	0.29	QP10F18X02B	MRE1022NV Y10D	3/8"
QP10F25X03D		0.25 X 0.03	0.98	0.29	QP10F25X03B		
QP10F38X05D*		0.38 X 0.05	1.12	0.39	—		

* Not cULus.

TYPE QN-M

FINGRIP™ Nylon Insulated Male Quick Disconnects

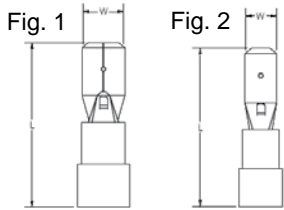

300 Volts Max., 105° C Max.

Nylon insulated quick disconnects allow for quickly connecting or disconnecting a terminal. The front end of the terminal has a male-type blade which slides into a female-type receptacle.

Features & Benefits

- Sleeved barrel
- Funnel entry barrel opening assures quick and easy wire insertion
- Mates with dimpled female socket detent ensuring firm grip

Catalog Number	Figure Number	Wire Range	NEMA Tab Size	L	W	Installation Tool	Wire Strip Length	Bulk Catalog Number
QN18M18X02D	2	18 - 22	0.19 X 0.02	0.80	0.19	MRE1022NV Y10D Y1022	3/8"	QN18M18X02B
QN18M25X03D	1		0.25 X 0.03	0.87	0.25			QN18M25X03B
QN14M18X02D	2	14 - 16	0.19 X 0.02	0.80	0.19	MRE1022NV Y10D Y1022	3/8"	QN14M18X02B
QN14M25X03D	1		0.25 X 0.03	0.87	0.25			QN14M25X03B
QN10M25X03D	1	12 - 10	0.25 X 0.03	0.95	0.25	MRE1022NV Y10D Y1022	3/8"	—

TYPE QN-F

FINGRIP™ Nylon Insulated Female Quick Disconnects

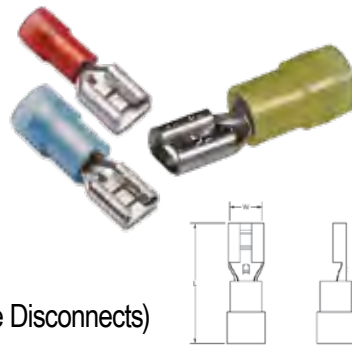

300 Volts Max., 105° C Max.

Nylon insulated quick disconnects allow for quickly connecting or disconnecting a terminal. The front end of the terminal has a female-type receptacle which slides onto a male-type blade.

Features & Benefits

- Sleeved barrel
- Insulated connector eliminate the need for post installation insulation
- Funnel entry barrel opening assures quick and easy wire insertion
- Dimpled female socket detent ensures firm grip

(Mates with Type QN-M Male Disconnects)

Standard Catalog Number	Std. Pkg. Qty.	Wire Range	NEMA Tab Size	L	W	Installation Tool	Wire Strip Length	Bulk Catalog Number	Bulk. Pkg. Qty.
QN18F11X02D	100	18 - 22	0.11 X 0.02	0.77	0.11	MRE1022NV Y10D Y1022	3/8"	QN18F11X02B	1000
QN18F18X02D			0.19 X 0.02	0.79	0.19			QN18F18X02B	
QN18F25X03D			0.25 X 0.03	0.87	0.25			QN18F25X03B	
QN14F11X02D	100	14 - 16	0.11 X 0.02	0.77	0.11	MRE1022NV Y10D Y1022	3/8"	QN14F11X02B	1000
QN14F18X02D			0.19 X 0.02	0.79	0.19			QN14F18X02B	
QN14F25X03D			0.25 X 0.03	0.87	0.25			QN14F25X03B	
QN10F18X02D*	50	12 - 10	0.19 X 0.02	0.87	0.19	MRE1022NV Y10D Y1022	3/8"	QN10F18X02B*	1000
QN10F25X03D			0.25 X 0.03	0.95	0.25			QN10F25X03B	

* Not cULus.

Small Terminals

Vinyl Fully Insulated Tin-Plated Brass Female Quick Disconnects /
Nylon Fully Insulated Tin-Plated Brass Male Quick Disconnects

TYPE FQP-F

FINGRIP™ Vinyl Fully Insulated Female Quick Disconnects

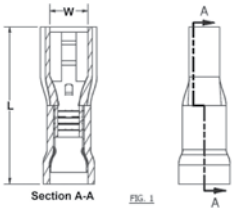

600 Volts Max., 105° C Max.

Vinyl insulated quick disconnects allow for quickly connecting or disconnecting a terminal. The front end of the terminal has a female-type receptacle which allows the terminal to slide onto a male-type blade.

Features & Benefits

- Fully insulated connectors eliminate the need for post installation insulation
- Funnel entry barrel opening assures quick and easy wire insertion
- Dimpled female socket detent ensuring firm grip

Catalog Number	Wire Range	NEMA Tab Size	L	W	Installation Tool	Wire Strip Length
FQP18F11X03D	18 - 22	0.11 X 0.03	0.79	0.11	MRE1022NV Y1022	3/8"
FQP18F18X02D		0.19 X 0.02	0.80	0.19		
FQP18F25X03D		0.25 X 0.03	0.90	0.25		
FQP14F11X03D	14 - 16	0.11 X 0.03	0.79	0.11	MRE1022NV Y1022	3/8"
FQP14F18X02D		0.19 X 0.02	0.80	0.19		
FQP14F25X03D		0.25 X 0.03	0.90	0.25		
FQP10F25X03D	10 - 12	0.25 X 0.03	0.97	0.25	MRE1022NV Y1022	3/8"

TYPE FQN-M

FINGRIP™ Nylon Fully Insulated Male Quick Disconnects

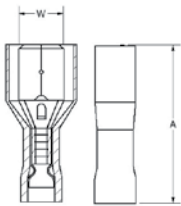

600 Volts Max., 105° C Max.

Nylon fully insulated quick disconnects allow for quickly connecting or disconnecting a terminal. The front end of the terminal has a male-type receptacle which slides into a female-type receptacle.

Features & Benefits

- Fully insulated connectors eliminate the need for post installation insulation
- Funnel entry barrel opening assures quick and easy wire insertion
- Dimpled female socket detent ensuring firm grip

Catalog Number	Wire Range	NEMA Tab Size	L	W	Installation Tool	Wire Strip Length	Bulk Catalog Number
FQN18M18X02D*	18 - 22	0.19 X 0.02	0.88	0.19	MRE1022NV Y10D Y1022	3/8"	—
FQN18M25X03D	18 - 22	0.25 X 0.03	0.80	0.25			FQN18M25X03B
FQN14M18X02D*	14 - 16	0.19 X 0.02	0.80	0.19	MRE1022NV Y10D Y1022	3/8"	—
FQN14M25X03D	14 - 16	0.25 X 0.03	0.88	0.25			FQN14M25X03B
FQN10M25X03D	10 - 12	0.25 X 0.03	0.96	0.25	MRE1022NV	3/8"	FQN10M25X03B

* Not cULus.

TYPE FQN-F

FINGRIP™ Nylon Fully Insulated Female Quick Disconnects

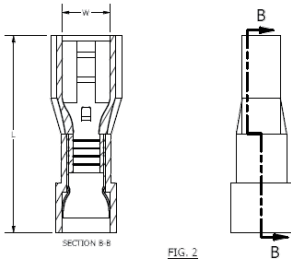

Tin Plated Brass; 300 Volts Max., 105° C Max.

Fully insulated quick disconnects allow for quickly connecting or disconnecting a terminal. The front end of the terminal has a female-type receptacle which allows the terminal to slide onto and off a male-type blade.

Features & Benefits

- Fully insulated connectors eliminate the need for post installation insulation
- Funnel entry barrel opening for quick and easy wire insertion
- Dimpled female socket detent for a firm grip

Catalog Number	Wire Range	NEMA Tab Size	L	W	Installation Tool	Wire Strip Length
FQN18F25X03D	18 - 22	.250 X .032	.90	.250	MRE1022NV Y10D Y1022	3/8"
FQN14F18X02D*	14 - 16	.187 x .020	.90	.187	MRE1022NV Y10D Y1022	3/8"
FQN14F25X03D	14 - 16	.250 X .032	.90	.250		
FQN10F25X03D	10 - 12	.250 X .032	.98	.250	MRE1022NV Y10D Y1022	3/8"

* Not cULus.

TYPE YHSQ-M

HYDENT™ Heat Shrink Insulated Male Quick Disconnects

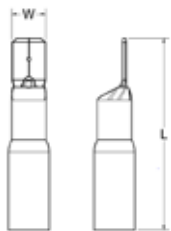

For Copper Conductor; -55° through 110°C

Standard crimp terminals leave the wire exposed allowing in moisture or other contaminants which can result in corrosion. Corrosion reduces the amount of current the wire can carry safely. The integrity of the electrical system can be compromised when unsealed electrical connections are utilized. Heat shrink terminals provide a durable seal blocking out contaminants ensuring a better connection.

Features & Benefits

- Made from pure copper, annealed for maximum strength
- Color-coded, imprinted with wire size
- Serrated barrels offer maximum wire contact and tensile strength
- Electro-tin plated for corrosion resistance

Catalog No. (100/bag)	Catalog No. (20/bag)	Conductor Size	NEMA Tab Size	Dimensions		Installation Tooling	Wire Strip Length
				W	L		
YHSQ18M25X03	YHSQ18M25X03RK	22-18 AWG	0.250 X 0.032	0.25	1.25	MR22	5/16"
YHSQ14M25X03	YHSQ14M25X03RK	16-14 AWG	0.250 X 0.032	0.25	1.25	MR22	5/16"
YHSQ10M25X03	YHSQ10M25X03RK	12-10 AWG	0.250 X 0.032	0.25	1.19	MR22	5/16"

TYPE YHSQ-F

HYDENT™ Heat Shrink Insulated Female Quick Disconnects

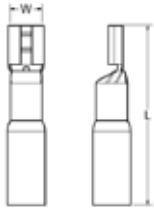

Tin Plated Brass; -55° through 110°C

Standard crimp terminals leave the wire exposed allowing in moisture or other contaminants which can result in corrosion. Corrosion reduces the amount of current the wire can carry safely. The integrity of the electrical system can be compromised when unsealed electrical connections are utilized. Heat shrink terminals provide a durable seal blocking out contaminants ensuring a better connection.

Features & Benefits

- Color-coded, imprinted with wire size
- Serrated barrels offer maximum wire contact and tensile strength
- Electro-tin plated for corrosion resistance

Catalog No. (100/bag)	Catalog No. (20/bag)	Conductor Size	Tab Size	Dimensions		Installation Tooling	Wire Strip Length
				W	L		
YHSQ18F11X02D	—	22-18 AWG	0.110 X 0.020	0.16	1.28	MR22	5/16"
YHSQ18F18X02D	—		0.187 X 0.020	0.23	1.28		
YHSQ18F25X03	YHSQ18F25X03RK		0.250 X 0.032	0.30	1.27		
YHSQ14F11X02D	—	16-14 AWG	0.110 X 0.020	0.16	1.28	MR22	5/16"
YHSQ14F18X02D	—		0.187 X 0.020	0.23	1.28		
YHSQ14F25X03	YHSQ14F25X03RK		0.250 X 0.032	0.30	1.27		
YHSQ10F25X03	YHSQ10F25X03RK	12-10 AWG	0.250 X 0.032	0.30	1.27	MR22	5/16"

TYPE YHSFQ-F

HYDENT™ Fully Insulated Female Quick Disconnects

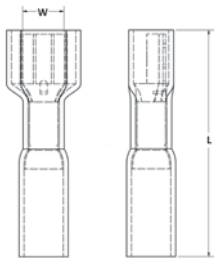

Tin Plated Brass; -55° through 110°C

Standard crimp terminals leave the wire exposed, allowing in moisture or other contaminants which can result in corrosion. Corrosion reduces the amount of current the wire can carry safely. The integrity of the electrical system can be compromised when unsealed electrical connections are utilized. Heat shrink terminals provide a durable seal blocking out contaminants ensuring a better connection.

Features & Benefits

- Color-coded, imprinted with wire size
- Serrated barrels offer maximum wire contact and tensile strength
- Electro-tin plated for corrosion resistance

Catalog No. (100/bag)	Catalog No. (20/bag)	Conductor Size	NEMA Tab Size	Dimensions		Installation Tooling	Wire Strip Length
				W	L		
YHSFQ18F25X03	YHSFQ18F25X03RK	22-18 AWG	0.250 X 0.032	0.38	1.28	MR22	5/16"
YHSFQ14F25X03	YHSFQ14F25X03RK	16-14 AWG	0.250 X 0.032	0.38	1.28	MR22	5/16"
YHSFQ10F25X03	YHSFQ10F25X03RK	12-10 AWG	0.250 X 0.032	0.38	1.34	MR22	5/16"

TYPE PG

Male / Female Combination Quick Disconnects

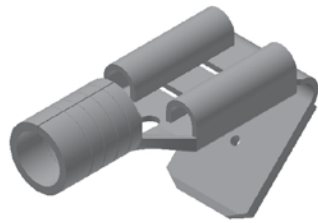
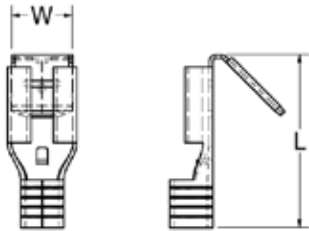

Tin-plated brass piggy-back connectors are designed to allow for additional terminals to be connected.

Features & Benefits

- Sleeved barrel
- Combination connector allows for more than one connection to a circuit
- Funnel entry barrel opening assures quick and easy wire insertion
- Dimpled female socket detent ensure firm grip

Catalog Number	Wire Range	NEMA Tab Size	L	W	Installation Tool	Wire Strip Length
PG1825X03D	22 - 18 AWG	0.250 X 0.032	0.79	0.25	MRE1022B, Y10D, Y1022	3/8"
PG1425X03D	16 - 14 AWG	0.250 X 0.032	0.79	0.25	MRE1022B, Y10D, Y1022	3/8"
PG1025X03D	12 - 10 AWG	0.250 X 0.032	0.89	0.25	MRE1022B, Y10D, Y1022	3/8"

TYPE PGHS

Heat Shrink Insulated Male / Female Combination Quick Disconnects

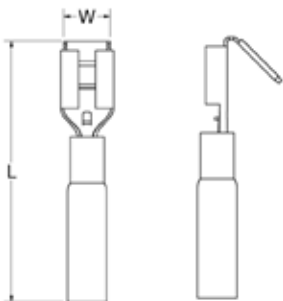

For Copper Conductor; -55° through 110°C

Standard crimp terminals leave the wire exposed, allowing in moisture or other contaminants which can result in corrosion. Corrosion reduces the amount of current the wire can carry safely. The integrity of the electrical system can be compromised when unsealed electrical connections are utilized. Heat shrink terminals provide a durable seal blocking out contaminants ensuring a better connection.

Features & Benefits

- Made from pure copper, annealed for maximum strength
- Color-coded, imprinted with wire size
- Serrated barrels offer maximum wire contact and tensile strength
- Electro-tin plated for corrosion resistance

Catalog Number	Wire Range	NEMA Tab Size	L	W	Installation Tool	Wire Strip Length
PGHS1825X03D	22 - 18 AWG	0.250 X 0.032	0.91	0.25	Y10D Y1022 MR22	5/16"
PGHS1425X03D	16 - 14 AWG	0.250 X 0.032	0.91	0.25	Y10D Y1022	5/16"

TYPE PGP

600 Volts Max., 105° C Max.

FINGRIP™ Vinyl Insulated Male/Female Combination Quick Disconnects

Tin-plated brass, vinyl insulated piggy-back connectors are designed to allow for additional terminals to be connected.

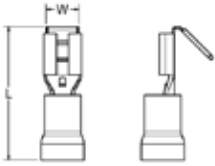

Features & Benefits

- Sleeved barrel
- Combination connector allows for more than one connection to a circuit
- Funnel entry barrel opening assures quick and easy wire insertion
- Dimpled female socket detent ensure firm grip

Standard Catalog Number	Wire Range	NEMA Tab Size	L	W	Installation Tool	Wire Strip Length	Bulk Catalog Number
PGP1825X03D	18 - 22	0.250 X 0.032	0.91	0.28	MRE1022NV Y1022	3/8"	PGP1825X03B
PGP1425X03D	14 - 16	0.250 X 0.032	0.91	0.28	MRE1022NV Y1022	3/8"	PGP1425X03B
PGP1025X03D	10 - 12	0.250 X 0.032	0.95	0.28	MRE1022NV Y1022	3/8"	PGP1025X03B

* For UL Listed applications, consult BURNDY® factory.

TYPE PGN

600 Volts Max., 105° C Max.

FINGRIP™ Nylon Insulated Male/Female Combination Quick Disconnects

Nylon insulated tin-plated brass quick disconnects allow for quickly connecting or disconnecting a terminal. The design also allows for additional terminals to be connected easily.

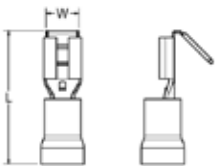

Features & Benefits

- Sleeved barrel
- Combination connector allows for more than one connection to a circuit
- Funnel entry barrel opening assures quick and easy wire insertion
- Dimpled female socket detent ensures firm grip

Standard Catalog Number	Wire Range	NEMA Tab Size	L	W	Installation Tool	Wire Strip Length	Bulk Catalog Number
PGN1825X03D	18 - 22	0.250 X 0.032	0.90	0.28	MRE1022NV Y10D	3/8"	PGN1825X03B
PGN1425X03D	14 - 16	0.250 X 0.032	0.90	0.28	MRE1022NV Y10D	3/8"	PGN1425X03B
PGN1025X03D	10 - 12	0.250 X 0.032	0.95	0.28	MRE1022NV Y10D	3/8"	PGN1025X03B

* For UL Listed applications, consult BURNDY® factory.

TYPE FLN

FINGRIP™ Nylon Flag-Style Female Quick Disconnect

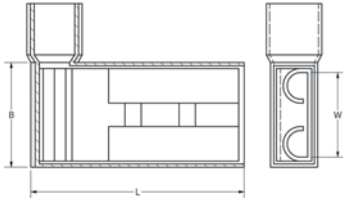

Flag style female quick disconnects provide quick, reliable, snap-together interconnections without the use of tools. Side entrance chamfer to permit connections of 90° without bending the wire.

Features & Benefits

- Dimpled female socket detent ensure firm grip



Catalog Number	Wire Range	NEMA Tab Size	L	B	W	Installation Tool	Wire Strip Length
FLN1825X03D	22 - 18	0.250 X 0.032	0.60	0.40	0.25	MRE1422FLN	3/8"
FLN1425X03D	16 - 14	0.250 X 0.032	0.63	0.40	0.25	MRE1422FLN	3/8"
FLN1025X03D*	12 - 10	0.250 X 0.032	0.64	0.40	0.25	MRE1422FLN	3/8"

* Not cULus.

TYPE FL

FINGRIP™ Flag-Style Female Quick Disconnect

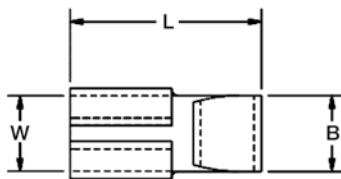
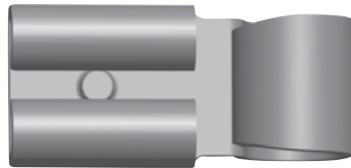

Flag style female quick disconnects provide quick, reliable, snap-together interconnections without the use of tools. Side entrance chamfer to permit connections of 90° without bending the wire.

Features & Benefits

- Dimpled female socket detent ensure firm grip



Catalog Number	Std. Pkg. Qty	Wire Range	NEMA Tab Size	L	B	W	Installation Tool	Wire Strip Length	Bulk Catalog Number	Bulk Pkg. Qty
FL1825X03D	100	18 - 22	0.250 x 0.032	0.67	0.17	0.25	BTH450	3/8"	FL1825X03B	1000
FL1425X03D	100	14 - 16	0.250 x 0.032	0.67	0.17	0.25	BTH450	3/8"	FL1425X03B	1000
FL1025X03D	50	10 - 12	0.250 x 0.032	0.67	0.17	0.25	BTH450	3/8"	FL1025X03B	1000

TYPE YAIT

QIKTAP™ Splices

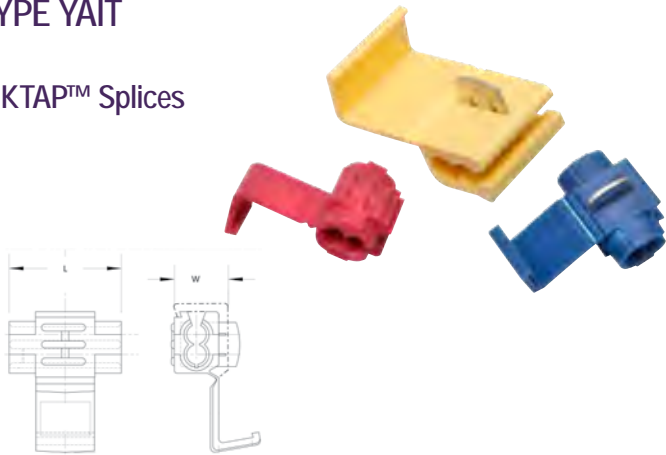

QIKTAP™ connectors are quick and convenient. Makes quick splices with no stripping, twisting, soldering, or special tooling.

Features & Benefits

- Easy to use
- Saves time
- Color coded
- No special tooling required, just squeeze to install
- Dependable connection

Catalog Number	Wire Range	L	W
YAIT2218R	22 - 18	0.80	0.37
YAIT1814B	16 - 14	0.80	0.37
YAIT1210Y	12 - 10	0.80	0.37

TYPE TTV

QIKTAP™ Tap Connectors

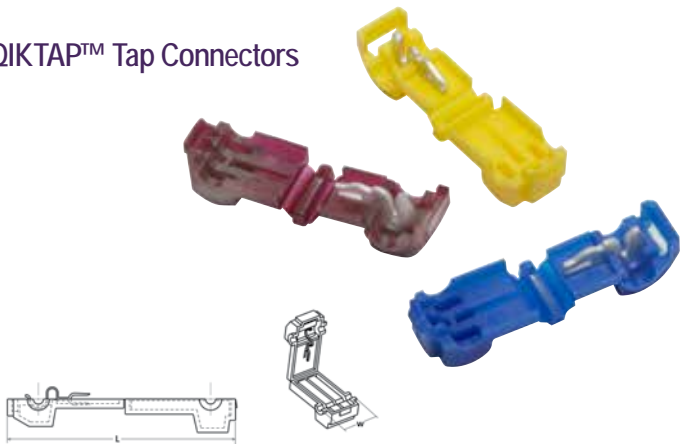

Type TTV electrical connectors allow for an easy tap off of a run conductor. This tap allows for a male quick disconnect to complete the tap connection. This is especially useful when multiple re-connections could be necessary.

Features & Benefits

- Allows user to tap into a wire in mid-span without cutting or stripping the wire
- Connector then mates with a .250 inch male quick disconnect tab, making a reusable quick-connect wiring termination

Catalog Number	Wire Range	Insulation Color	W	L
TTV18	22 - 18 AWG	Red	0.38	1.44
TTV14	16 - 14 AWG	Blue	0.38	1.44
TTV10	12 - 10 AWG	Yellow	0.38	1.44

TYPE PTV

VINYLUG™

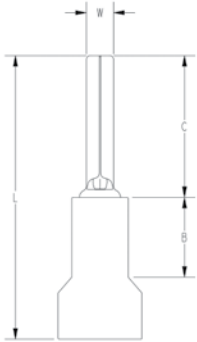

Insulated Pin Terminals are electrical connectors used to terminate stranded wires, creating a quality, reliable connection by ensuring each wire strand conducts current when properly crimped. This is especially useful when multiple reconnections could be necessary within terminal blocks or other similar devices. No breakage of wire strands when wire is bent, under stress or in a vibration environment.

Features & Benefits

- Vinyl insulation
- Color-coded barrels
- Provides an easy and effective way to terminate stranded wire into European/metric-style terminal blocks

Catalog Number	Wire Range	B	C	L	W	Installation Tooling	Wire Strip Length
PTV18	22 - 18 AWG	0.19	0.41	0.80	0.07	MRE1022NV Y1022	5/16"
PTV14	16 - 14 AWG	0.19	0.41	0.80	0.07	MRE1022NV Y1022	5/16"
PTV10	12 - 10 AWG	0.27	0.50	0.97	0.11	MRE1022NV Y1022	5/16"

TYPE YF-UIL

Bare Ferrules

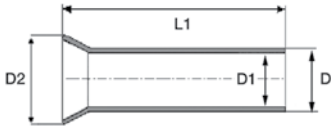

For Use on Copper Conductor

Wire ferrules are also known as cord end terminals or bootlace ferrules. These are electrical connectors used to terminate stranded wires. Made of electrolytically tin plated copper, uninsulated ferrules are designed to form neat end terminations to multi-strand cables or wires. Smooth funnel entry assists in wire insertion.

Features & Benefits

- Made of electrolytic copper, tin plated
- Seamless barrels
- Smooth funnel entry to make wire insertion easier
- RoHS compliant

Catalog Number	Wire Size		Dimensions in Inches				Recommended Tooling
	AWG	mm ²	L1 Dim (in)	D Dim (in)	D1 Dim (in)	D2 Dim (in)	
YF2006UIL	20	0.75	0.24	0.06	0.05	0.10	YF268CFSL YF261CSKIT with YF2610D die YF2210FL†
YF2010UIL	20	0.75	0.39	0.06	0.05	0.08	
YF2012UIL	20	0.75	0.47	0.06	0.05	0.08	
YF1806UIL	18	1.00	0.24	0.07	0.06	0.11	
YF1808UIL	18	1.00	0.32	0.07	0.06	0.09	
YF1810UIL	18	1.00	0.39	0.07	0.06	0.09	
YF1812UIL	18	1.00	0.47	0.07	0.06	0.09	
YF1607UIL	16	1.50	0.28	0.08	0.07	0.09	
YF1608UIL	16	1.50	0.32	0.08	0.07	0.12	
YF1610UIL	16	1.50	0.39	0.08	0.07	0.12	
YF1612UIL	16	1.50	0.47	0.08	0.07	0.12	
YF1618UIL	16	1.50	0.71	0.08	0.07	0.12	
YF1408UIL	14	2.50	0.32	0.10	0.09	0.13	
YF1410UIL	14	2.50	0.39	0.10	0.09	0.13	
YF1412UIL	14	2.50	0.47	0.10	0.09	0.13	
YF1418UIL	14	2.50	0.71	0.10	0.09	0.13	
YF1209UIL	12	4.00	0.35	0.13	0.11	0.15	
YF1212UIL	12	4.00	0.47	0.13	0.11	0.17	
YF1215UIL	12	4.00	0.59	0.13	0.11	0.15	
YF1218UIL	12	4.00	0.71	0.13	0.11	0.15	
YF1010UIL	10	6.00	0.39	0.15	0.14	0.19	YF268CFSL YF2210FL†
YF1012UIL	10	6.00	0.47	0.15	0.14	0.19	
YF1015UIL	10	6.00	0.59	0.15	0.14	0.19	
YF1018UIL	10	6.00	0.71	0.15	0.14	0.19	
YF0812UIL	8	10.00	0.47	0.19	0.18	0.29	YF268CFSL YF261CSKIT with YF864D die
YF0815UIL	8	10.00	0.59	0.19	0.18	0.29	
YF0818UIL	8	10.00	0.71	0.19	0.18	0.29	
YF0612UIL	6	16.00	0.47	0.24	0.23	0.30	YF261CSKIT with YF864D die
YF0615UIL	6	16.00	0.59	0.24	0.23	0.30	
YF0618UIL	6	16.00	0.71	0.24	0.23	0.30	
YF0625UIL	6	16.00	0.98	0.24	0.23	0.30	

† Not currently UL Listed when using the YF2210FL tool.

TYPE YF-UIL (Continued)



Catalog Number	Wire Size		Dimensions in Inches				Recommended Tooling
	AWG	mm ²	L1 Dim (in)	D Dim (in)	D1 Dim (in)	D2 Dim (in)	
YF0412UIL *	4	25.00	0.47	0.31	0.29	0.38	YF261CSKIT with YF864D die
YF0415UIL	4	25.00	0.59	0.31	0.29	0.38	
YF0418UIL	4	25.00	0.70	0.31	0.29	0.38	
YF0420UIL	4	25.00	0.79	0.31	0.29	0.38	
YF0425UIL	4	25.00	0.98	0.31	0.29	0.38	
YF0432UIL	4	25.00	1.26	0.31	0.29	0.38	
YF0215UIL *	2	35.00	0.59	0.34	0.33	0.42	YF261CSKIT with YF21D die
YF0220UIL	2	35.00	0.79	0.34	0.33	0.42	
YF0225UIL	2	35.00	0.98	0.34	0.33	0.42	
YF0232UIL	2	35.00	1.26	0.34	0.33	0.42	
YF0118UIL *	1	50.00	0.71	0.43	0.41	0.52	81K Series
YF0122UIL *	1	50.00	0.87	0.43	0.41	0.52	
YF0125UIL *	1	50.00	0.98	0.43	0.41	0.52	
YF0132UIL *	1	50.00	1.26	0.43	0.41	0.52	
YF1/018UIL	1/0	50.00	0.71	0.43	0.41	0.52	
YF1/022UIL	1/0	50.00	0.87	0.43	0.41	0.52	
YF1/025UIL	1/0	50.00	0.98	0.43	0.41	0.52	
YF1/032UIL	1/0	50.00	1.26	0.43	0.41	0.52	
YF2/022UIL *	2/0	70.00	0.87	0.56	0.53	0.64	
YF2/025UIL *	2/0	70.00	0.98	0.56	0.53	0.64	
YF2/032UIL *	2/0	70.00	1.26	0.56	0.53	0.64	
YF3/025UIL *	3/0	95.00	0.98	0.61	0.58	0.68	
YF3/030UIL *	3/0	95.00	1.18	0.61	0.58	0.68	
YF3/032UIL *	3/0	95.00	1.26	0.61	0.58	0.68	
YF4/032UIL *	4/0	120.00	1.26	0.69	0.66	0.81	
YF4/034UIL *	4/0	120.00	1.39	0.69	0.66	0.81	
YF4/040UIL *	4/0	120.00	1.57	0.69	0.66	0.81	
YF25032UIL *	250	150.00	1.26	0.81	0.72	0.91	
YF25040UIL *	250	150.00	1.57	0.81	0.72	0.91	
YF35032UIL *	350	185.00	1.26	0.84	0.79	0.94	
YF35040UIL *	350	185.00	1.57	0.84	0.80	0.94	

* Not UL Listed

TYPE YF-I-L Series W, D, & T

Covered Ferrules



Offered in Series D, T, & W

Ferrules are electrical connectors used to terminate stranded wires, creating a quality, reliable connection by ensuring each wire strand conducts current when properly crimped. Especially useful when multiple reconnections could be necessary within terminal blocks or other similar devices. No breakage of wire strands when wire is bent, under stress or in a vibration environment. Twin ferrule designs allow two individual stranded conductors to be connected to the same termination, most beneficial in jumpering or similar applications. Both styles (single and twin) offer the same features and benefits.

Features & Benefits

- Made of electrolytic copper, tin plated
- Smooth funnel entry to make wire insertion easier
- Secure contacting even after multiple reconnections
- Long-term contact resistance
- No fraying of strands
- No breakage of wire strands when wire is bent, under stress, or in vibration environment
- RoHS compliant

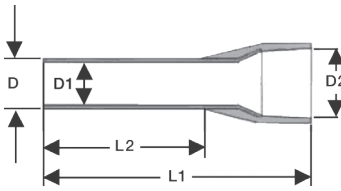

W Series	D Series	T Series	Wire Size		Dimensions in Inches					Bag Qty	Tooling
			AWG	mm ²	L1 (in)	L2 (in)	D (in)	D1 (in)	D2 (in)		
YF2406IWL Turquoise	—	YF2406ITL Pink	24	0.34	0.40	0.31	0.04	0.03	0.08	500	YF268CFSL
YF2408IWL Turquoise	—	YF2408ITL Pink	24	0.34	0.48	0.31	0.04	0.03	0.08	500	YF261CSKIT with YF2610D die
—	YF2205IDL * White	—	22	0.50	0.44	0.21	0.05	0.04	0.11	500	YF268CFSL YF261CSKIT with YF2610D die YF2210FL†
YF2206IWL Orange	YF2206IDL White	YF2206ITL White	22	0.50	0.47	0.24	0.05	0.04	0.10	500	
YF2208IWL Orange	YF2208IDL White	YF2208ITL White	22	0.50	0.55	0.32	0.05	0.04	0.11	500	
YF2210IWL Orange	YF2210IDL White	YF2210ITL White	22	0.50	0.63	0.39	0.05	0.04	0.10	500	
YF2212IWL Orange	YF2212IDL White	YF2212ITL White	22	0.50	0.47	0.24	0.05	0.04	0.10	500	
YF2006IWL White	YF2006IDL Gray	YF2006ITL Blue	20	0.75	0.47	0.24	0.06	0.05	0.11	500	
YF2008IWL White	YF2008IDL Gray	YF2008ITL Blue	20	0.75	0.56	0.31	0.06	0.05	0.12	500	
YF2010IWL White	YF2010IDL Gray	YF2010ITL Blue	20	0.75	0.63	0.39	0.06	0.05	0.11	500	
YF2012IWL White	YF2012IDL Gray	YF2012ITL Blue	20	0.75	0.71	0.47	0.06	0.05	0.11	500	
YF2018IWL White	YF2018IDL Gray	YF2018ITL Blue	20	0.75	0.96	0.71	0.06	0.05	0.11	500	
YF1806IWL Yellow	YF1806IDL Red	YF1806ITL Red	18	1.00	0.47	0.24	0.07	0.06	0.12	500	
YF1808IWL Yellow	YF1808IDL Red	YF1808ITL Red	18	1.00	0.56	0.32	0.07	0.05	0.12	500	
YF1810IWL Yellow	YF1810IDL Red	YF1810ITL Red	18	1.00	0.63	0.39	0.07	0.06	0.12	500	
YF1812IWL Yellow	YF1812IDL Red	YF1812ITL Red	18	1.00	0.71	0.47	0.07	0.06	0.12	500	
YF1818IWL Yellow	YF1818IDL Red	YF1818ITL Red	18	1.00	0.96	0.71	0.07	0.06	0.12	500	

* Not UL Listed

† Not currently UL Listed when using the YF2210FL tool.

TYPE YF-I-L Series W, D, & T

(Continued)

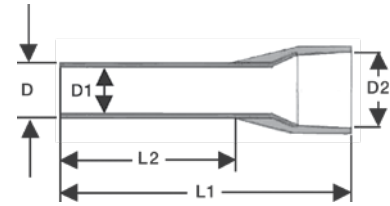

W Series	D Series	T Series	Wire Size		Dimensions in Inches					Bag Qty	Tooling
			AWG	mm ²	L1 (in)	L2 (in)	D (in)	D1 (in)	D2 (in)		
YF1606IWL * Red	YF1606IDL * Black	YF1606ITL * Black	16	1.50	0.48	0.24	0.08	0.07	0.14	500	YF268CFSL YF261CSKIT with YF2610D die YF2210FL†
YF1608IWL Red	YF1608IDL Black	YF1608ITL Black	16	1.50	0.55	0.32	0.08	0.07	0.14	500	
YF1610IWL Red	YF1610IDL Black	YF1610ITL Black	16	1.50	0.63	0.39	0.08	0.07	0.14	500	
YF1612IWL Red	YF1612IDL Black	YF1612ITL Black	16	1.50	0.71	0.47	0.08	0.07	0.14	500	
—	YF1615IDL Black	—	16	1.50	0.84	0.59	0.08	0.07	0.14	500	
YF1618IWL Red	YF1618IDL Black	YF1618ITL Black	16	1.50	0.95	0.71	0.08	0.07	0.14	500	
YF1408IWL Blue	YF1408IDL Blue	YF1408ITL Gray	14	2.50	0.62	0.32	0.10	0.09	0.17	500	
YF1410IWL Blue	YF1410IDL Blue	YF1410ITL Gray	14	2.50	0.69	0.39	0.09	0.09	0.17	500	
YF1412IWL Blue	YF1412IDL Blue	YF1412ITL Gray	14	2.50	0.71	0.47	0.09	0.09	0.17	500	
YF1418IWL Blue	YF1418IDL Blue	YF1418ITL Gray	14	2.50	0.95	0.71	0.09	0.09	0.17	500	
YF1209IWL * Gray	YF1209IDL * Gray	YF1209ITL * Orange	12	4.00	0.65	0.32	0.13	0.11	0.19	500	
YF1210IWL Gray	YF1210IDL Gray	YF1210ITL Orange	12	4.00	0.71	0.39	0.13	0.11	0.13	500	
YF1212IWL Gray	YF1212IDL Gray	YF1212ITL Orange	12	4.00	0.79	0.47	0.13	0.11	0.19	500	
YF1218IWL Gray	YF1218IDL Gray	YF1218ITL Orange	12	4.00	1.02	0.71	0.13	0.11	0.19	500	
YF1010IWL * Black	YF1010IDL * Yellow	YF1010ITL * Green	10	6.00	0.73	0.39	0.15	0.14	0.25	100	
YF1012IWL Black	YF1012IDL Yellow	YF1012ITL Green	10	6.00	0.82	0.47	0.15	0.14	0.23	100	
YF1018IWL Black	YF1018IDL Yellow	YF1018ITL Green	10	6.00	1.02	0.71	0.15	0.15	0.25	100	
YF0812IWL Ivory	YF0812IDL Red	YF0812ITL Brown	8	10.00	0.91	0.46	0.19	0.18	0.31	100	
—	YF0815IDL Red	—	8	10.00	0.93	0.59	0.19	0.18	0.29	100	
YF0818IWL Ivory	YF0818IDL Red	YF0818ITL Brown	8	10.00	1.10	0.71	0.19	0.18	0.29	100	
YF0612IWL Green	YF0612IDL Blue	YF0612ITL Ivory	6	16.00	0.89	0.43	0.25	0.23	0.34	100	
YF0618IWL Green	YF0618IDL Blue	YF0618ITL Ivory	6	16.00	0.89	0.43	0.25	0.23	0.34	100	

* Not UL Listed

† Not currently UL Listed when using the YF2210FL tool.

Small Terminals

Covered Ferrules for Copper Conductor
Series W, D, & T

TYPE YF-I-L Series W, D, & T

(Continued)

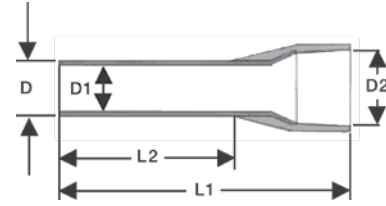

W Series	D Series	T Series	Wire Size		Dimensions in Inches					Bag Qty	Tooling
			AWG	mm ²	L1 (in)	L2 (in)	D (in)	D1 (in)	D2 (in)		
YF0412IWL *	YF0412IDL *	—	4	25.00	0.94	0.47	0.31	0.29	0.44	100	YF261CSKIT with YF864D die
YF0415IWL *	YF0415IDL *	—	4	25.00	1.06	0.59	0.30	0.29	0.44	100	
YF0416IWL	YF0416IDL	YF0416ITL	4	25.00	1.10	0.63	0.30	0.29	0.44	100	
—	YF0418IDL	—	4	25.00	1.18	0.71	0.30	0.29	0.44	100	
—	YF0422IDL	—	4	25.00	1.42	0.87	0.30	0.29	0.44	100	
—	YF0425IDL	—	4	25.00	1.45	0.98	0.30	0.29	0.44	100	
—	YF0216IDL	—	2	35.00	1.17	0.64	0.34	0.32	0.48	100	YF261CSKIT with YF21D die
YF0218IWL	YF0218IDL	YF0218ITL	2	35.00	1.26	0.71	0.34	0.33	0.50	100	
—	YF0222IDL	—	2	35.00	1.41	0.87	0.34	0.33	0.50	100	
—	YF0225IDL	—	2	35.00	1.53	0.98	0.34	0.33	0.50	100	
—	YF0112IDL *	—	1	50.00	1.10	0.47	0.43	0.41	0.59	50	YF261CSKIT with YF21D die
—	YF0116IDL *	—	1	50.00	1.26	0.63	0.43	0.41	0.59	50	
—	YF0120IDL *	—	1	50.00	1.45	0.79	0.43	0.40	0.58	50	
—	YF0122IDL *	—	1	50.00	1.50	0.87	0.43	0.41	0.59	50	
—	YF0125IDL *	—	1	50.00	1.57	0.98	0.43	0.41	0.59	50	
—	YF1/012IDL *	—	1/0	50.00	1.10	0.47	0.43	0.41	0.59	50	
—	YF1/016IDL *	—	1/0	50.00	1.26	0.63	0.43	0.41	0.59	50	
—	YF1/020IDL	—	1/0	50.00	1.45	0.79	0.43	0.40	0.58	50	
—	YF1/022IDL	—	1/0	50.00	1.50	0.87	0.43	0.41	0.59	50	
—	YF1/025IDL	—	1/0	50.00	1.57	0.98	0.43	0.41	0.59	50	
—	YF2/020IDL *	—	2/0	70.00	1.45	0.79	0.56	0.53	0.63	25	81K Series
—	YF2/025IDL *	—	2/0	70.00	1.65	0.98	0.56	0.53	0.63	25	
—	YF2/032IDL *	—	2/0	70.00	1.73	1.10	0.56	0.53	0.63	25	

* Not UL Listed

TYPE YFTW-IDL Series D

Covered Twin Ferrules

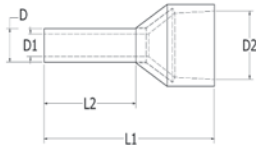

For Use on Copper Conductor

Ferrules are electrical connectors used to terminate stranded wires, creating a quality, reliable connection by ensuring each wire strand conducts current when properly crimped. Especially useful when multiple reconnections could be necessary within terminal blocks or other similar devices. No breakage of wire strands when wire is bent, under stress or in a vibration environment. Twin ferrule designs allow two individual stranded conductors to be connected to the same termination, most beneficial in jumpering or similar applications. Both styles (single and twin) offer the same features and benefits. RoHS compliant.

Features & Benefits

- Made of electrolytic copper, tin plated
- Smooth funnel entry to make wire insertion easier
- Secure contacting even after multiple reconnections
- No fraying or breakage of wire strands when wire is bent, under stress, or in vibration environment

Catalog Number	Wire sizes		Dimensions in Inches					Tooling	Bag Qty
	AWG	mm ²	L1 Dim (in)	L2 Dim (in)	D Dim (in)	D1 Dim (in)	D2 Dim (in)		
YFTW2208DL White	22 AWG	0.50	0.60	0.30	0.07	0.06	0.19	YF268CFSL YF261CSKIT with YF2610D die YF2210FL†	500
YFTW2008DL Gray	20 AWG	0.75	0.60	0.31	0.08	0.07	0.20		
YFTW2010DL Gray	20 AWG	0.75	0.66	0.39	0.08	0.07	0.22		
YFTW1808DL Red	18 AWG	1.00	0.62	0.31	0.09	0.08	0.22		
YFTW1810DL Red	18 AWG	1.00	0.67	0.39	0.09	0.08	0.22		
YFTW1608DL Black	16 AWG	1.50	0.65	0.31	0.10	0.09	0.26		
YFTW1612DL Black	16 AWG	1.50	0.77	0.47	0.10	0.09	0.25		
YFTW1410DL Blue	14 AWG	2.50	0.77	0.39	0.13	0.11	0.31		
YFTW1413DL Blue	14 AWG	2.50	0.85	0.51	0.13	0.11	0.32		
YFTW1212DL Gray	12 AWG	4.00	0.92	0.46	0.17	0.15	0.36		
YFTW1014DL Yellow	10 AWG	6.00	0.99	0.53	0.21	0.19	0.41	YF261CSKIT with YF2610D die YF2210FL†	100
YFTW0814DL Red	8 AWG	10.00	1.04	0.55	0.27	0.25	0.51	YF261CSKIT with YF864D die	
YFTW0614DL Blue	6 AWG	16.00	1.23	0.55	0.34	0.33	0.75		

† Not currently UL Listed when using the YF2210FL tool.

Small Terminal Kits

Packaged Kits of Various Types of Small Terminals



For Use on Copper Conductor

Small terminal kits are packaged in reusable plastic cases with secure compartments of each type of connector. Clearly marked on the inside front cover with part numbers and descriptions, the kits contain some of the most common terminals needed on everyday installations.

Features & Benefits

- Quality terminals of various types packaged together for convenience
- Color-coded barrels
- Reusable, refillable case
- Clearly marked with part numbers and descriptions on inside cover



Catalog Number: STKIT08

Contains:

Kit	Catalog Number	Quantity	Description
STKIT08	SP14	20	#16 - #14 AWG splice; vinyl insulation
	QP14M25X03D	10	#16 - #14 AWG male disconnect; .250 tab size; vinyl insulation
	QP14F25X03	10	#16 - #14 AWG female disconnect; .250 tab size; vinyl insulation
	TP1410	20	#16 - #14 AWG ring terminal; 8 - 10 stud size; vinyl insulation
	TP1410F	20	#16 - #14 AWG fork terminal; 8 - 10 stud size; vinyl insulation
	SP10	10	#12 - #10 AWG splice; vinyl insulation
	TP1010	20	#12 - #10 AWG ring terminal; 8 - 10 stud size; vinyl insulation
	TP1010F	20	#12 - #10 AWG fork terminal; 8 - 10 stud size; vinyl insulation

Catalog Number: STKIT15

Contains:

Kit	Catalog Number	Quantity	Description
STKIT15	QP18M18X02D	20	#22 - #18 AWG male disconnect; .187 tab; vinyl insulation
	QP18M25X03D	20	#22 - #18 AWG male disconnect; .250 tab; vinyl insulation
	QP18F18X02D	20	#22 - #18 AWG female disconnect; .187 tab; vinyl insulation
	QP18F25X03D	20	#22 - #18 AWG female disconnect; .250 tab; vinyl insulation
	BULM18P	20	#22 - #18 AWG male bullet disconnect; vinyl insulation
	BULF18P	20	#22 - #18 AWG female bullet disconnect; vinyl insulation
	SP18	20	#22 - #18 AWG splice; vinyl insulation
	QP14M18X02D	20	#16 - #14 AWG male disconnect; .187 tab; vinyl insulation
	QP14M25X03D	20	#16 - #14 AWG male disconnect; .250 tab; vinyl insulation
	QP14F18X02D	20	#16 - #14 AWG female disconnect; .187 tab; vinyl insulation
	QP14F25X03D	20	#16 - #14 AWG female disconnect; .250 tab; vinyl insulation
	BULM14P	20	#16 - #14 AWG male bullet disconnect; vinyl insulation
	BULF14P	20	#16 - #14 AWG female bullet disconnect; vinyl insulation
	SP14	20	#16 - #14 AWG splice; vinyl insulation
	SP10	20	#12 - #10 AWG splice; vinyl insulation

Small Terminal Kits

(Continued)

Packaged Kits of Terminals with Installation Tool

Small terminal kits are packaged in durable, dual-latched metal cases with secure compartments for each connector. Inside label clearly identifies the part number and description of the connector associated with each compartment. The kits contain some of the most common terminals needed for everyday installation.

Features & Benefits

- Terminals include rings, forks, splices, quick disconnects, and pin styles
- Color-coded barrels
- Reusable, refillable case
- Kit available with MRE1022NV full cycle ratchet installation tool



STKIT1602MRE1022NV

STKIT1602MRE1022NV KIT CONTENTS				
Catalog Number	Qty	Description	Wire Size	Stud Size
MRE1022NV	1	Mechanical Full Cycle Ratchet Tool	—	—
PTV18	100	Vinyl Pin Terminal	22 - 18 AWG	—
PTV14	100	Vinyl Pin Terminal	16 - 14 AWG	—
PTV10	100	Vinyl Pin Terminal	12 - 10 AWG	—
QP14M25X03D	100	Vinyl Male Disconnect	16 - 14 AWG	—
QP14F25X03D	100	Vinyl Female Disconnect	16 - 14 AWG	—
QP10M25X03D	100	Vinyl Male Disconnect	12 - 10 AWG	—
QP10F25X03D	50	Vinyl Female Disconnect	12 - 10 AWG	—
TP1610	100	Vinyl Ring Tongue	22 - 16 AWG	#10
TP1410	100	Vinyl Ring Tongue	16 - 14 AWG	#10
TP1010	50	Vinyl Ring Tongue	12 - 10 AWG	#10
TP166LF	100	Vinyl Locking Fork	22 - 16 AWG	#6
TP148LF	100	Vinyl Locking Fork	16 - 14 AWG	#8
TP1010LF	50	Vinyl Locking Fork	12 - 10 AWG	#10
SP16	100	Vinyl Splice	22 - 16 AWG	—
SP14	50	Vinyl Splice	16 - 14 AWG	—
SP10	40	Vinyl Splice	12 - 10 AWG	—

TYPE HSKIT

Packaged Kit of Heat Shrink Connectors with Installation Tool



For Use on Copper Conductor

Standard crimp terminals leave the wire exposed, allowing in moisture or other contaminants which can result in corrosion. Heat shrink terminals provide a durable seal, blocking out contaminants, ensuring a better connection.

Features & Benefits

- Made from pure copper, annealed for maximum strength
- Color-coded, imprinted with wire size
- Serrated barrels offer maximum wire contact and tensile strength
- Electro-tin plated for corrosion resistance
- Wire strip length 5/16"

List of Items Included in HSKIT

Quantity of Pieces included in kit	Description	Conductor Size	Stud Size	Quantity of Pieces included in kit	Description	Conductor Size	Stud Size
50	Butt Splice	22 - 18 AWG	—	10	Fork Terminal	22 - 18 AWG	#6
50	Butt Splice	16 - 14 AWG	—	10	Fork Terminal	22 - 18 AWG	#8
30	Butt Splice	12 - 10 AWG	—	10	Fork Terminal	22 - 18 AWG	#10
15	Butt Splice	#8 AWG	—	10	Fork Terminal	16 - 14 AWG	#6
10	Ring Terminal	22 - 18 AWG	#6	10	Fork Terminal	16 - 14 AWG	#8
10	Ring Terminal	22 - 18 AWG	#8	10	Fork Terminal	16 - 14 AWG	#10
10	Ring Terminal	22 - 18 AWG	#10	10	Fork Terminal	12 - 10 AWG	#6
10	Ring Terminal	22 - 18 AWG	5/16"	10	Fork Terminal	12 - 10 AWG	#8
10	Ring Terminal	22 - 18 AWG	1/4"	10	Fork Terminal	12 - 10 AWG	#10
10	Ring Terminal	22 - 18 AWG	3/8"	15	Fork Terminal	#8 AWG	3/8"
10	Ring Terminal	16 - 14 AWG	#8	50 (25 ea)	Male & Female Quick Disc.	22 - 18 AWG	—
10	Ring Terminal	16 - 14 AWG	#10	50 (25 ea)	Male & Female Quick Disc.	16 - 14 AWG	—
10	Ring Terminal	16 - 14 AWG	5/16"	50 (25 ea)	Male & Female Quick Disc.	12 - 10 AWG	—
10	Ring Terminal	16 - 14 AWG	1/4"	30 (15 ea)	Male & Female Bullet	16 - 14 AWG	—
10	Ring Terminal	16 - 14 AWG	3/8"	20 (10 ea)	Male & Female Ins. Quick Disc.	22 - 18 AWG	—
10	Ring Terminal	16 - 14 AWG	#6	20 (10 ea)	Male & Female Ins. Quick Disc.	16 - 14 AWG	—
10	Ring Terminal	12 - 10 AWG	#8	20 (10 ea)	Male & Female Ins. Quick Disc.	12 - 10 AWG	—
10	Ring Terminal	12 - 10 AWG	#10	10	Step Down Butt Splice	16 - 14 to 22 - 18 AWG	—
10	Ring Terminal	12 - 10 AWG	5/16"	10	Step Down Butt Splice	12 - 10 to 16 - 14 AWG	—
10	Ring Terminal	12 - 10 AWG	1/4"	1	Ratchet Crimp Tool	—	—
10	Ring Terminal	12 - 10 AWG	3/8"	1	Metal Case with Dividers	—	—
15	Ring Terminal	#8 AWG	#10				

TYPES YQE / RK

Rated 600 Volts (Building Wire) and 1000 Volts (Fixtures/Signs)

Pigtail Splice, Nylon Insulated

The BURCAP is a nylon insulated pigtail splice designed to splice a wide range of different cable sizes.

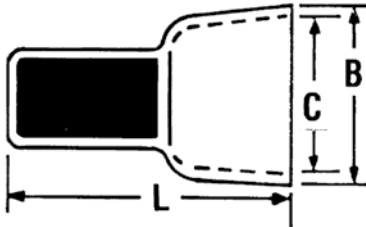

Catalog Number	Wire Combinations								Total Area Circular Mils	Dimension in Inches			Installation Tools M8ND, Y8ND, HYTOOL™	Wire Strip Length
										L	B	C		
YQE91†	1 # 16 & 1 # 18,								4205	0.76	0.30	0.24	N150WT	5/16"
	2# 18								3250					
*RK1412	RK141ABOX100				RK142ABOX100				500 - 5,180	0.61 (16, 4)	0.31 (7, 9)	0.27 (8, 6)		
	22	20	18	16	18	16	14	12						
*RK1422	7					1	1	2,400 - 13,100	0.72 (18, 3)	0.44 (11, 2)	0.38 (9, 8)			
	6	1				2	1							
	5		1			3	1							
	4	2			1		1							
	4		1		2		1							
	3	2			3		1							
	3		2			1	1							
	3			1		2	1							
	2	3			1		1							
	2		2		2		1							
	2			1	3		1							
	1	4			2	2	1							
	1		2				2							
	1			1	1	1								
		4			2	1								
		3	1		3	1								
		2	2		4	1								
		2		1	1	2								
		1	2		2	2								
		1		1	3	2								
			3			2								
		2		1	3									
					3									
				5										

NOTE:

* Convenience Package. For Box quantity, order RK141ABOX100 and RK142ABOX100 respectively.

† This item is UL Listed

Small Terminals

This Page Intentionally Left Blank

Table of Contents

Compression Connectors

Connector Selector Chart.....	C-3
Compression Connectors Information.....	C-5
Capacity Rating, Selection and Use, Tooling.....	C-5
Installation Hardware, Industry Standards.....	C-5
Telecommunications Connector Information.....	C-6
Wire Definitions.....	C-7
Plating Objective Table.....	C-7

Code Connectors Accommodating Flexible Wire

444S / 644 Series of Tools.....	C-8
4-POINT® 81K Series of Tools.....	C-9

Expanded Ranges

444S / 644 Series of Tools.....	C-10
4-POINT® 81K, 4PC Series of Tools.....	C-11

Copper Compression - Code - Standard Barrel

One Hole w/ Inspection Window.....	C-13
One Hole Narrow Tongue w/ Inspection Window.....	C-18
Two Hole w/ Inspection Window.....	C-21
One Hole Narrow Tongue w/ Inspection Window.....	C-26
Two Hole Slotted w/ Inspection Window (Code/Flex).....	C-28
Four Hole Split Tongue w/ Inspection Window.....	C-29
One/Two Hole Narrow Tongue E-LINE.....	C-30

Copper Code Standard Barrel Terminal Tooling Tables/Instructions

Mechanical/Ratchet (Dedicated Die/Requiring Dies).....	C-32
Hydraulic (Requires Dies / Dieless).....	C-33
Installation Instructions.....	C-35

Copper Compression - Code - Long Barrel

One Hole w/ Inspection Window.....	C-36
One Hole No Inspection Window.....	C-40
Two Hole w/ Inspection Window.....	C-44
Two Hole No Inspection Window.....	C-48
Two Hole Narrow Tongue No Inspection Window.....	C-52
Two Hole Slotted w/ Inspection Window.....	C-55
Two Hole Slotted No Inspection Window.....	C-56
Four Hole No Inspection Window.....	C-57
Four Hole Split Tongue w/ Inspection Window.....	C-58
Blank Tongue No Inspection Window.....	C-59

Copper Code Long Barrel Terminal Tooling Tables/Instructions

Mechanical/Ratchet (Dedicated Die/Requiring Dies).....	C-62
Hydraulic (Requires Dies / Dieless).....	C-63
Installation Instructions.....	C-65

Copper Compression - Flex - Standard Barrel

Copper Flex Wire Table.....	C-66
One Hole w/ Inspection Window.....	C-67
One Hole No Inspection Window.....	C-71
One Hole Narrow Tongue w/ Inspection Window.....	C-74
One Hole Belled End w/ Inspection Window.....	C-76
One Hole Tin-Zinc Plated No Inspection Window.....	C-78
Two Hole w/ Inspection Window.....	C-81
Two Hole Narrow Tongue w/ Inspection Window.....	C-85
Two Hole Slotted w/ Inspection Window.....	C-87
Two Hole Tin-Zinc Plated No Inspection Window.....	C-88
Four Hole Split Tongue w/ Inspection Window.....	C-91

Copper Flex Standard Barrel Terminal Tooling Tables/Instructions

Mechanical/Ratchet (Dedicated Die/Requiring Dies).....	C-93
Hydraulic (Requires Dies / Dieless).....	C-94
Installation Instructions.....	C-96

Copper Compression - Flex - Long Barrel

One Hole w/ Inspection Window.....	C-97
One Hole Belled End No Inspection Window.....	C-100
Two Hole w/ Inspection Window.....	C-103
Two Hole Belled End No Inspection Window.....	C-106
Two Hole Narrow Tongue w/ Inspection Window.....	C-109
Two Hole Slotted w/ Inspection Window.....	C-111

Copper Flex Long Barrel Terminal Tooling Tables/Instructions

Mechanical/Ratchet (Dedicated Die/Requiring Dies).....	C-113
Hydraulic (Requires Dies / Dieless).....	C-114
Installation Instructions.....	C-116

Unique Feature Copper Compression Connectors

Blank Tongue Long Barrel (Code).....	C-59
Two Hole Standard Barrel, Slotted (Code/Flex).....	C-28
Two Hole Long Barrel, Slotted w/ Inspection Window (Code).....	C-55
Two Hole Long Barrel, Slotted No Inspection Window (Code).....	C-56
Two Hole Long Barrel, Slotted w/ Inspection Window (Flex).....	C-111
Split Tongue Standard Barrel (Code).....	C-29
Split Tongue Long Barrel (Code).....	C-58
Equipment Line, One & Two Hole Narrow Tongue (Code).....	C-30

Aluminum / Copper Compression Connections

One Hole for Aluminum/Copper.....	C-117
Two and Four Hole for Aluminum/Copper.....	C-120
One/Two Hole Narrow Tongue Standard Barrel (Code).....	C-123
Transformer Lug Kit.....	C-129

Aluminum Terminal Tooling Tables/Instructions

Mechanical/Ratchet (Dedicated Die/Requiring Dies).....	C-125
Hydraulic (Requires Dies).....	C-126
Hydraulic (Dieless).....	C-127
Installation Instructions.....	C-128

Metric Compression Connectors

One Hole Standard Barrel - Code w/ Inspection Window.....	C-130
Two Hole Standard Barrel - Code w/ Inspection Window.....	C-134
One Hole Long Barrel - Code No Inspection Window.....	C-137
Two Hole Long Barrel - Code No Inspection Window.....	C-140
One Hole Standard Barrel - Flex w/ Inspection Window.....	C-144
Two Hole Long Barrel - Flex w/ Inspection Window.....	C-147
One Hole Long Barrel - Flex No Inspection Window.....	C-150
Two Hole Long Barrel - Flex No Inspection Window.....	C-153

Stacking Adaptor Connectors

HYSTACK™ for Copper/Aluminum.....	C-156
-----------------------------------	-------

Copper Compression Splices

Uninsulated Parallel Splice.....	C-157
Standard Barrel Splice (Code).....	C-159
Long Barrel Splice (Code).....	C-160
High-Voltage Standard Barrel Tapered Ends (Code).....	C-161
Standard Barrel Splice (Flex).....	C-162

Most frequently ordered catalog numbers are highlighted in BLUE

Table of Contents

Copper Flex Standard Barrel Splice Tooling Tables/Instructions	
Mechanical/Ratchet (Dedicated Die/Requiring Dies)	C-164
Hydraulic (Requires Dies / Dieless)	C-165
Installation Instructions.....	C-167
Copper Compression Splice	
Long Barrel (Flex)	C-168
Copper Flex Long Barrel Splice Tooling Tables/Instructions	
Mechanical/Ratchet (Dedicated Die/Requiring Dies)	C-170
Hydraulic (Requires Dies / Dieless)	C-171
Installation Instructions.....	C-173
Copper Compression In Line Splice Kits	
Code/Flex Standard Barrel w/ Inspection Window.....	C-174
Aluminum Compression Splices	
HYLINK™ for Aluminum/Copper.....	C-176
Copper Compression Reducing Adapter	
Reducing Adapter for Copper (Code).....	C-178
Copper Compression In-Line Reducer Splice Kit (Code/Flex)	
Standard Barrel w/ Inspection Window	C-179
Hydraulic Installation Tooling Chart (standard barrel)	C-187
Mechanical Installation Tooling Chart (standard barrel)	C-197
Long Barrel w/ Inspection Window.....	C-206
Hydraulic Installation Tooling Chart (long barrel)	C-209
	Mechanical Installation Tooling Chart (long barrel)
	C-209
Aluminum/Copper Reducing Splice	
HYREDUCER™ Aluminum Reducing Splice.....	C-215
Compression Tap Connectors & Covers	
Thin Wall Copper C-Tap	C-216
C-Tap CRIMPIT™	C-217
H-Tap CRIMPIT™ (Code)	C-219
H-Tap Flame Retardant Cover (black)	C-223
H-Tap Flame Retardant Cover (clear)	C-223
Split H Copper CRIMPIT™	C-224
Tin Plated Aluminum H-Tap.....	C-225
Copper Compression Adapters	
HYPLUG™ Adapters for Copper.....	C-226
HYPLUG™ Adapters for Aluminum.....	C-228
Copper Compression T-Coupler	
Copper HYTEE™ Coupler (Code)	C-230
Compression Cable Pulling Heads	
Compression Cable Pulling Heads Aluminum/Copper.....	C-231
Compression Battery Terminals	
Straight Style Battery Post	C-233
T-Style Battery Post	C-234
One Hole Grounding/Starter Lugs.....	C-235

Most frequently ordered catalog numbers are highlighted in BLUE



The BURNDY QR Code provides you with a single point of access to all BURNDY Compression Connection Resource Documents

Compression Connection Product Categories

- Copper Code Terminals
- Copper Flex Terminals
- Copper Codes Splices
- Copper Flex Splices
- Copper Splice Reducers
- Copper Pin Adapters
- Copper C & H-Taps
- Aluminum Terminals
- Aluminum Splices
- Aluminum Splice Reducers
- Steel Cable Pulling Heads



Types of Resource Documents Available:

- Installation Manuals
- Installation Videos
- Installation Instructions
- Tooling Tables
- Sales Drawings
- Product Selection Configurators
- Burndy Connect Application



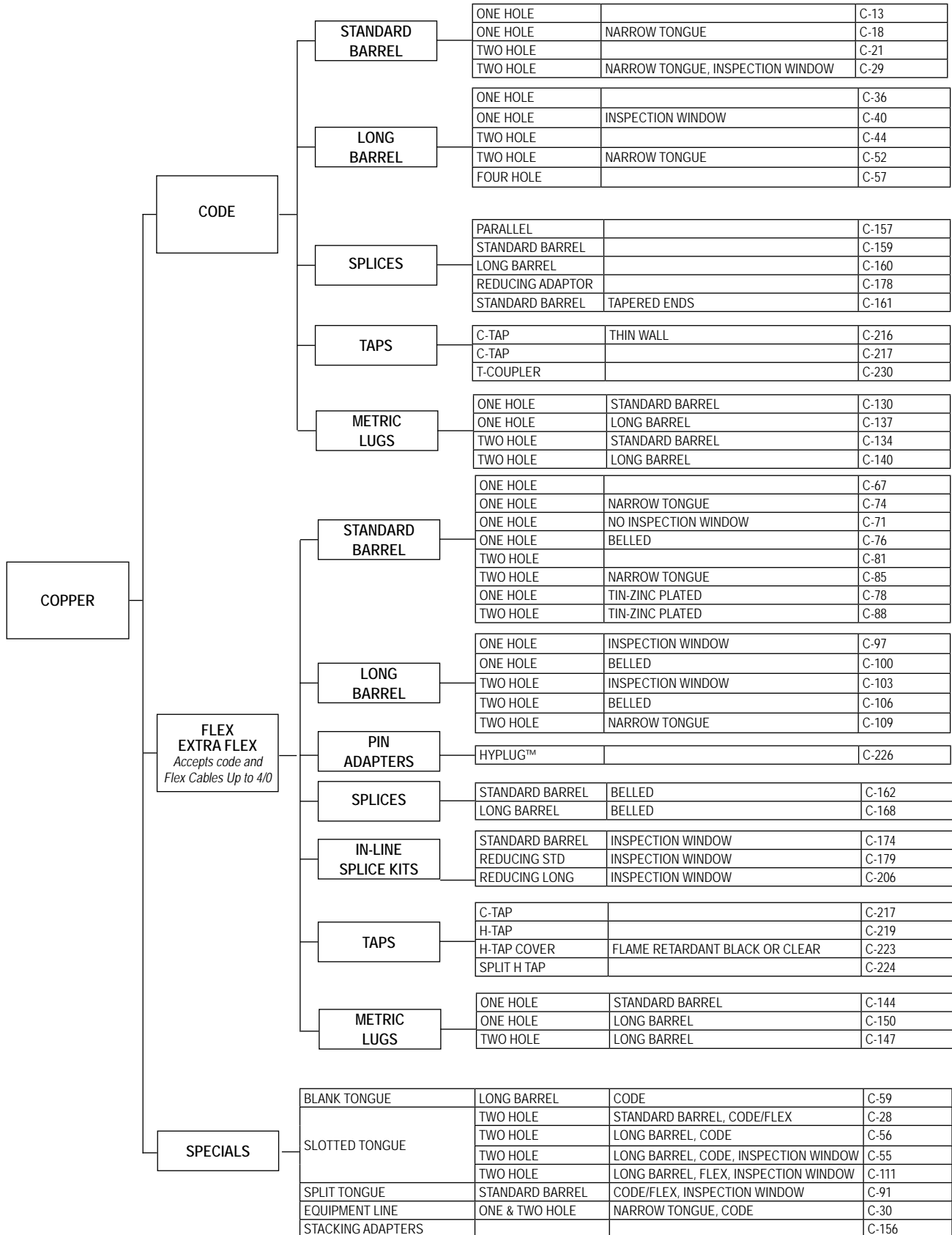

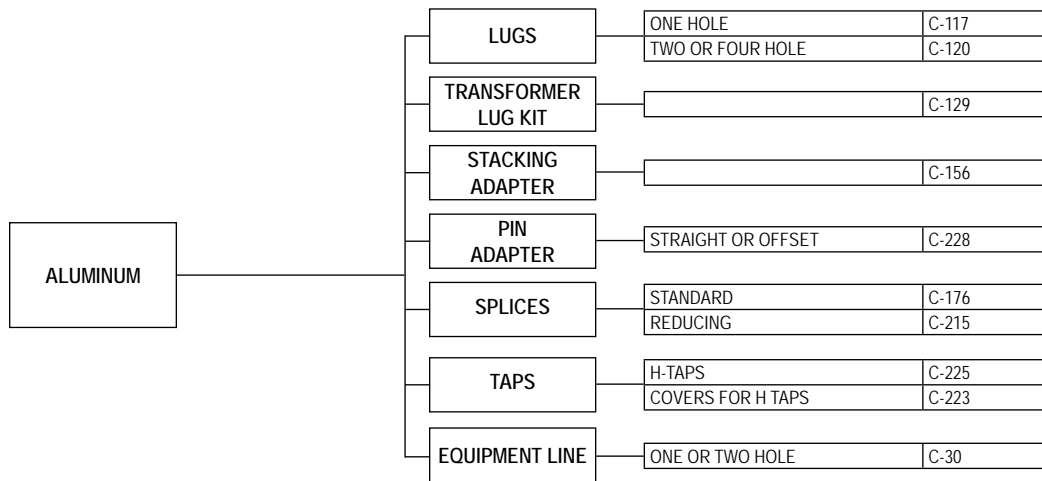

Compression Connectors

BURNDY® compression connectors are designed for reliable and controllable electrical connections. The complete installation is fully inspectable. They are high conductivity copper and operate cooler than the wire on which they are installed. The connectors withstand a wide range of electrical and environmental conditions, including current surges, temperatures, corrosion and vibrations, for a wide variety of applications. These features mean a consistently high quality connection at a low installed cost.

Copper compression connectors are manufactured from high-conductivity electrolytic copper. The connectors are normally tin-plated, lead-plated, or plated with proprietary BURNDY® brite finish to provide durable long-lasting corrosion resistance. The connector design has been matched to the cable size to provide the necessary physical strength requirements for reliable electrical performance.

Aluminum compression connectors are manufactured from high conductivity, high purity wrought aluminum. They are designed with sufficient mass and are electro-tin plated to minimize corrosion due to galvanic action between dissimilar metals. The connector barrels are pre-filled with PENETROX™, BURNDY oxide inhibiting compound.

PENETROX™ contains homogeneously suspended metallic particles which penetrate the wire's oxides to establish excellent continuity between the individual strands and the connector barrel for a low-resistance connection. PENETROX™ maintains an airtight connection. Each barrel end is covered with a color-coded plastic dust cap which prevents foreign matter from entering the connector before it is used. The connector design has been engineered to match the cable size to provide the necessary physical strength requirements for reliable electrical performance.

Connector Ampacity Rating

Per NEC 110.14(C) Provision (2) installed pressure connectors shall be used with conductors at the ampacities not exceeding the ampacity at the listed and identified temperature rating of the connector. Most BURNDY connector temperature ratings in this section, are rated 90°C, therefore the connector is rated to accommodate the ampacity of a conductor operating at or below 90°C.

Selection and Use

Copper compression connectors are recommended for use on copper conductors. Aluminum compression connectors are recommended for use on aluminum conductors. Dual-rated aluminum compression connectors may be used on both copper and aluminum conductors.

Two basic compression designs are available: Circumferential and indent. After compression, virtually all the air is removed leaving a tight homogeneous mass of connector and conductor.



The circumferential crimp design is recommended for color coded connectors in low and high voltage applications. Die index number embossment

provides an easy inspection where required to verify the use of the proper connector/die combination. It is also recommended for insulated connectors and for terminating flexible and welding cables.

The circumferential crimp design dies compress cable strands into polygonal shapes forming intimate contact with each other and the connector barrel. This compression forms a tight homogeneous mass with virtually no air pockets. The circumferential crimp provides an excellent electrical connection with high pull-out values. The circumferential crimp is ideal for high voltage applications leaving the connector barrel symmetrical, which is easier to insulate.

The indent type crimp can be used in virtually any application except polyvinylchloride (PVC) insulated terminals and splices. It is an excellent means of terminating flexible, extra flexible and welding cables. The indenter compresses the cable strands to form intimate contact with each other and the connector barrel. The result is an excellent electrical connection with high pull-out strength. Laboratory work testing curves established the proper depth and shape of indent for each type of connector and wire combination.

Tooling

Tooling systems are essential for proper installation of a compression connector. Since connectors and dies are designed as a unit for specific wire sizes, only the recommended tools and dies should be used. Most aluminum and copper HYLUG™ terminals and HYLINK™ splices are marked with a die index number and are color-coded to identify the correct installation die. Dies marked with the matching die index number and color can be used to install the connector.

BURNDY® tooling installs a wide range of connectors, is reliable, cost effective, and precision engineered for durable, long-lasting service and quality connections. The tools include small plier types, full cycle ratchet designs and hydraulically-powered HYPRESS™ heads and new Battery Actuated Tools. Some have permanent die grooves or adjustable dies, while others require a change of die sets or nest die for each connector size. BURNDY recommended tools achieve crimp performance consistent with UL and other industry standards. Since several tools are suitable for most connectors, the most economical and practical tool can be chosen for each application.

Installation Hardware

See the Hardware Section or Reference Section of the BURNDY Master Catalog for information on Recommended Hardware Materials and Tightening Torque Values.

Industry Standards

BURNDY compression terminals, splices, and tap connectors requiring third party testing and approval are listed by Underwriters Laboratories, Inc. (UL), and/or Canadian Standards Association (CSA), and all confirm to the applicable sections of the National Electrical Code (NEC).

Per UL486A-486B - Wire Connectors (1.3) standard, this standard is intended for connectors suitable for currents not exceeding the ampacity of insulated conductors rated 75°C or 90°C in accordance with the rating of the connector, if provided.

BURNDY® also offers connectors and splices which meet the (LOCA Seismic and Aging) requirements of IEEE standards 323, 383 and 344 for class 1E critical circuits for use in Nuclear Utility Applications. Certification to 10CFR50 and 10CFR21 available.

Detail catalog listings should be consulted to obtain the appropriate standards for each connector and splice.

Telecommunication Compression Connectors

The industry's first choice in compression connectors...

BURNDY® provides a complete selection of one and two hole compression terminals, H-taps, C-taps, and other compression connection products specifically engineered to meet the demanding applications of both the Central Office and Wireless communications markets.

All of the BURNDY compression products are designed for reliable and controllable electrical connections. All connectors are made from high conductivity electrolytic copper and operate at cooler temperatures than the conductor on which they are installed. The connectors are normally tin-plated, lead-plated, or plated with a proprietary BURNDY® brite finish to provide the industry standard in long-lasting corrosion resistance.

The complete installation is fully inspectable and UL Listed when installed with BURNDY® dies. Every die in the system is color-coded and provides die index embossment for complete inspectability.

BURNDY® Tooling... the right choice for the job!

BURNDY® tooling installs a wide range of connectors, is reliable, cost effective, and precision engineered for durable, long-lasting service and quality connections. BURNDY compression tooling system ranges from full cycle ratchet hand tools to 12 and 15 ton hydraulically-powered HYPRESS™ heads. Hydraulic tools are available in self-contained, battery powered, and AC service electrically powered pump and remote head designs to meet all possible installation situations.

The Circumferential Crimp...

The BURNDY® circumferential crimp provides a solid, homogenous connection, with high pull out values and is rated for high voltage applications, more than sufficient for the 48V DC operating voltage common in the telecom market. In addition the circumferential crimp doesn't require the removal of the copper flash produced by other die systems. This not only saves time in installation but removes a potential safety hazard from the job.

All of the dies in the system are color-coded to match the connectors and feature die index and die number matching to the connector for ease of installation.



Circumferential compression is solid and symmetrical. No sharp flash.

NOTE: Field bending straight lugs to achieve an angular connection will void UL Listing / CSA Certifications and BURNDY will not be liable for the connection.

Wire Definitions

- Copper Code Stranded Wire, as listed in this section refers to: Class B (Concentric, Compressed, Compact) or Class C
- Copper Flexible Wire, as listed in this section refers to: Listed by Nominal Wire followed by the designated wire classes (G, H, I, K, M, and DLO)
- Aluminum Stranded Wire, as listed in this section refers to: Class B (Concentric, Compressed, Compact)
- Copper Clad Aluminum (CCA) Stranded Wire, as listed in this section refers to: CCA stranded wire

Objective	Plating			
	Electro-tin	Hot Tin Dip	Nickel	Silver*
Reduce galvanic corrosion (bimetallic)	X	X	—	—
Resist corrosive elements	X	X	—	—
Increase conductivity/lower contact resistance	—	—	—	X
Provide high, continuous service temperatures (maximum)	X (347°F/175°C)	—	X (650°F/343°C)	X (500°F/260°C)
*Note: Never connect an aluminum surface to a silver plated surface. Aluminum in contact with silver results in a highly corrosive joint, which will further result in a high resistance connection.				

Compression Connections

Code Connectors Accommodating Flexible Wire with 444S and 644 Series Dieless Tools

Code Connectors Accommodating Flexible Wire with Dieless Tools

The following code connectors can accommodate flexible wire when using the 644 or 444S series dieless platform of installation tools ONLY. See table for specific connector to wire combinations.

Example: YA2CN code connector that accommodates #2 AWG Class B,C, can also accommodate a #3 Class G, H, I, K, M, DLO flexible wire when using a 644 or 444S series tools with the number of crimps identified in the table below.



Catalog Number Designation		Wire Sizes		# Crimps*	
Terminal	Splice*	Copper Code Wire	Copper Flexible Wire and DLO (if applicable)	Standard Barrel	Long Barrel
YA1C-	YS1C-	#1 AWG	#2 FLEX G,H,I,K,M,DLO	1	1
YA25-	YS25-	1/0 AWG	#1 FLEX G,H,I,K,M,DLO	1	1
YA26-	YS26-	2/0 AWG	1/0 FLEX G,H,I,K,M,DLO	1	1
YA27-	YS27-	3/0 AWG	2/0 FLEX G,H,I,K,M,DLO	1	1
YA28-	YS28-	4/0 AWG	3/0 FLEX G,H,I,K,M,DLO	1	1
YA29-	YS29-	250 kcmil	4/0 FLEX G,H	1	1
YA30-	YS30-	300 kcmil	4/0 FLEX I,K,M,DLO 250 FLEX G,H	1	1
YA31-	YS31-	350 kcmil	250 FLEX I,K,M, 262 DLO	1	1
YA32-	YS32-	400 kcmil	300 FLEX G,H,I,K,M, 313 DLO	1	1
YA34-	YS34-	500 kcmil	350 FLEX G,H,I,K,M, 373 DLO	1	1
YA36-	YS36-	600 kcmil	450 FLEX I,K,M, 444 DLO 500 FLEX G,H	1	1
YA38-	YS38-	700 kcmil	500 FLEX I,K,M, 535 DLO 550 FLEX G,H	1	1
YA39-	YS39-	750 kcmil	600 FLEX G 550 FLEX M	1	1
YA40-	YS40-	800 kcmil	600 FLEX H,I,K,M 650 FLEX G, 646 DLO	1	1
YA44-	YS44-	1000 kcmil	650 FLEX I 750 FLEX G,H, 777 DLO	1	1

*Splices: # of crimps required for each side



Code Connectors Accommodating Flexible Wire with Dieless Tools

The following code connectors can accommodate flexible wire when using the 81K series 4-POINT® dieless platform of installation tools ONLY. See table for specific connector to wire combinations.

Example: YA2CN code connector that accommodates #2 AWG Class B,C, can also accommodate a #3 Class G, H, I, K, M, DLO flexible wire when using an 81K series tool with the number of crimps identified in the table below.



Catalog Number Designation		Wire Sizes		# Crimps*	
Terminal	Splice*	Copper Code Wire	Copper Flexible Wire and DLO (if applicable)	Standard Barrel	Long Barrel
YA8C-	YS8C-	#8 AWG	#8 FLEX G,H,I,K,M,DLO	1	1
YA4C-	YS4C-	#4 AWG	#6 FLEX G,H,I,K,M,DLO #5 FLEX G,H,I,K,M,DLO	1	1
YA3C-	YS3C-	#3 AWG	#4 FLEX G,H,I,K,M,DLO	1	1
YA2C-	YS2C-	#2 AWG	#3 FLEX G,H,I,K,M,DLO	1	1
YA1C-	YS1C-	#1 AWG	#2 FLEX G,H,I,K,M,DLO	1	1
YA25-	YS25-	1/0 AWG	#1 FLEX G,H,I,K,M,DLO	1	2
YA26-	YS26-	2/0 AWG	1/0 FLEX G,H,I,K,M,DLO	1	2
YA27-	YS27-	3/0 AWG	2/0 FLEX G,H,I,K,M,DLO	1	2
YA28-	YS28-	4/0 AWG	3/0 FLEX G,H,I,K,M,DLO	1	2
YA29-	YS29-	250 kcmil	4/0 FLEX G,H	1	2
YA30-	YS30-	300 kcmil	4/0 FLEX I,K,M,DLO 250 FLEX G,H	1	2
YA31-	YS31-	350 kcmil	250 FLEX I,K,M, 262 DLO	1	2
YA32-	YS32-	400 kcmil	300 FLEX G,H,I,K,M, 313 DLO	1	2
YA34-	YS34-	500 kcmil	350 FLEX G,H,I,K,M, 373 DLO	1	2
YA36-	YS36-	600 kcmil	450 FLEX I,K,M, 444 DLO 500 FLEX G,H	2	2
YA38-	YS38-	700 kcmil	500 FLEX I,K,M, 535 DLO	2	2
			550 FLEX G,H	2	2
YA39-	YS39-	750 kcmil	600 FLEX G	2	3
			550 FLEX M	2	3
YA40-	YS40-	800 kcmil	600 FLEX H,I,K,M	2	3
			650 FLEX G, 646 DLO	2	3
YA44-	YS44-	1000 kcmil	650 FLEX I	—	3
			750 FLEX G,H, 777 DLO	2	3

*Splices: # of crimps required for each side



Code Class B/C Terminal
(YA2CN shown)

+



Flexible Wire Accommodates
(#3 G,H,I,K,M,DLO)

+



=



UL Listed
CSA Certified

EXPANDED RANGES



The following list of connector types can accommodate a range of conductors when crimped using the 644 and 444S family of tools:

COPPER CONNECTORS

Copper HYLUG™ & HYLINK™ Connectors Types YA, YA-L, YAB, YS, YS-L, YSR, YST, YS-T, YSP-T			
Catalog No.		Copper Wire Size	Copper Expanded Wire Range
Terminal*	Splice**		
YA4C- YA3C- YA2C- YA1C-	YS4C- YS3C- YS2C- YS1C-	#4 AWG #3 AWG #2 AWG #1 AWG	#4 AWG #3 - #4 AWG #2 - #4 AWG #1 - #4 AWG
YA25- YA26- YA27- YA28-	YS25- YS26- YS27- YS28-	1/0 AWG 2/0 AWG 3/0 AWG 4/0 AWG	1/0 - #4 AWG 2/0 - #4 AWG 3/0 - #2 AWG 4/0 - #1 AWG
YA29- YA30- YA31- YA32- YA34-	YS29- YS30- YS31- YS32- YS34-	250 kcmil 300 kcmil 350 kcmil 400 kcmil 500 kcmil	250 kcmil - 1/0 AWG 300 kcmil - 2/0 AWG 350 kcmil - 3/0 AWG 400 kcmil - 4/0 AWG 500 kcmil - 4/0 AWG
YA36- YA39- YA40-	YS36- YS39- YS40-	600 kcmil 750 kcmil 800 kcmil	600 - 250 kcmil 750 - 500 kcmil 800 - 500 kcmil
YA44-	YS44-	1000 kcmil	1000 - 750 kcmil

* 1 Crimp
** 1 Crimp per side

ALUMINUM CONNECTORS

Aluminum HYLUG™ & HYLINK™ Connectors Types YA-A & YS-A			
Catalog No.		Copper or Aluminum Wire Size	Copper or Aluminum Expanded Wire Range
Terminal*	Splice**		
YA6CA- YA4CA- YA2CA- YA1CA-	YS6CA- YS4CA- YS2CA- YS1CA-	#6 AWG #4 AWG #2 AWG #1 AWG	#6 AWG #4 - #6 AWG #2 - #6 AWG #1 - #2 AWG
YA25A- YA26A- YA27A- YA28A-	YS25A- YS26A- YS27A- YS28A-	1/0 AWG 2/0 AWG 3/0 AWG 4/0 AWG	1/0 - #1 AWG 2/0 - #1 AWG 3/0 - #1 AWG 4/0 - #1 AWG
YA29A- YA30A- YA31A- YA32A- YA34A-	YS29A- YS30A- YS31A- YS32A- YS34A-	250 kcmil 300 kcmil 350 kcmil 400 kcmil 500 kcmil	250 kcmil - 1/0 AWG 300 kcmil - 2/0 AWG 350 kcmil - 3/0 AWG 400 kcmil - 4/0 AWG 500 kcmil - 4/0 AWG
YA36A- YA39A- YA40A- YA42A- †	YS36A- YS39A- YS40A- YS42A- ‡	600 kcmil 750 kcmil 800 kcmil 900 kcmil ▲	600 - 250 kcmil 750 - 500 kcmil 800 - 500 kcmil 900 - 600 kcmil
YA44A-	YS44A-	1000 kcmil	1000 - 750 kcmil

* 1 Crimp
** 1 Crimp per side
▲ 900 AL only
† 2 Crimps
‡ 2 Crimps per side

AYP/AYPO ALUMINUM CONNECTORS

(Aluminum Conductor Only)				
Wire Size	Expanded Range	Pin		# Crimps
		Straight	Offset	
#6 AWG	#6 AWG	AYP6	—	1
#4 AWG	#4 AWG	AYP4	—	1
#2 AWG	#4 - #2 AWG	AYP2	—	1
#1 AWG	#2 - #1 AWG	AYP1	—	1
1/0 AWG	#1 - 1/0 AWG	AYP1/0	—	1
2/0 AWG	#1 - 2/0 AWG	AYP2/0	AYPO2/0	2
3/0 AWG	#1 - 3/0 AWG	AYP3/0	AYPO3/0	2
4/0 AWG	#1 - 4/0 AWG	AYP4/0	AYPO4/0	2
250 kcmil	1/0 - 250 kcmil	AYP250	AYPO250	2
300 kcmil	2/0 - 300 kcmil	AYP300	AYPO300	2
350 kcmil	3/0 - 350 kcmil	AYP350	AYPO350	2
400 kcmil	4/0 - 400 kcmil	AYP400	AYPO400	2
500 kcmil	4/0 - 500 kcmil	AYP500	AYPO500	2
600 kcmil	250 - 600 kcmil	AYP600	AYPO600	3
750 kcmil	500 - 750 kcmil	AYP750	AYPO750	3



EXPANDED RANGES

The following list of connector types can accommodate a range of conductors when crimped using the 4-POINT® (81K or 4PC) family of tools:



COPPER CONNECTORS

Copper Conductor (Class B&C)**							
Copper Conductor		Standard Barrel			Long Barrel		
Wire Size	Expanded Range	Terminal	Splice	# of Crimps*	Terminal	Splice	# of Crimps*
#8 AWG	#8 AWG	YA8CL-	YS8CL-	1	YA8C-	YS8C-	1
#6 AWG	#6 AWG	YA6CL-	YS6CL-	1	YA6C-	YS6C-	1
#4 AWG	#6 - #4	YA4CL-	YS4CL-	1	YA4C-	YS4C-	1
#2 AWG	#6-#2	YA2CL-	YS2CL-	1	YA2C-	YS2C-	2
#1 AWG	#6-#1	YA1CL-	YS1CL-	1	YA1C-	YS1C-	2
1/0 AWG	#6-1/0	YA25L-	YS25L-	1	YA25-	YS25-	2
2/0 AWG	#4 - 2/0	YA26L-	YS26L-	1	YA26-	YS26-	2
3/0 AWG	#2 - 3/0	YA27L-	YS27L-	2	YA27-	YS27-	2
4/0 AWG	#1 - 4/0	YA28L-	YS28L-	2	YA28-	YS28-	2
250 kcmil	1/0 - 250	YA29L-	YS29L-	2	YA29-	YS29-	2
300 kcmil	2/0 - 300	YA30L-	YS30L-	2	YA30-	YS30-	3
350 kcmil	3/0 - 350	YA31L-	YS31L-	2	YA31-	YS31-	3
400 kcmil	4/0 - 400	YA32L-	YS32L-	2	YA32-	YS32-	3
500 kcmil	4/0 - 500	YA34L-	YS34L-	2	YA34-	YS34-	4
600 kcmil	250 - 600	YA36L-	YS36L-	2	YA36-	YS36-	4
700 kcmil	350-700	YA38L-	YS38L-	3	YA38-	YS38-	4
750 kcmil	500-750	YA39L-	YS39L-	3	YA39-	YS39-	4
800 kcmil	500-800	YA40L-	YS40L-	3	YA40-	YS40-	4
1000 kcmil	750-1000	YA44L-	YS44L-	3	YA44-	YS44-	4

ALUMINUM CONNECTORS

Aluminum & Copper Conductor (Class B & C)**				
Copper / Aluminum Conductor		Connector		
Wire Size	Expanded Range	Terminal	Splice	# Crimps
#8 AWG	#8 AWG	YA8CA-	YS8CA-	1
#6 AWG	#6 AWG	YA6CA-	YS6CA-	1
#4 AWG	#6 - #4 AWG	YA4CA-	YS4CA-	1
#2 AWG	#6-#2 AWG	YA2CA-	YS2CA-	2
#1 AWG	#6-#1 AWG	YA1CA-	YS1CA-	2
1/0 AWG	#6-1/0 AWG	YA25A-	YS25A-	2
2/0 AWG	#4 - 2/0 AWG	YA26A-	YS26A-	2
3/0 AWG	#2 - 3/0 AWG	YA27A-	YS27A-	2
4/0 AWG	#1 - 4/0 AWG	YA28A-	YS28A-	2
250 kcmil	1/0 - 250	YA29A-	YS29A-	2
300 kcmil	2/0 - 300	YA30A-	YS30A-	2
350 kcmil	3/0 - 350	YA31A-	YS31A-	3
400 kcmil	4/0 - 400	YA32A-	YS32A-	4
500 kcmil	4/0 - 500	YA34A-	YS34A-	4
600 kcmil	250 - 600	YA36A-	YS36A-	4
750 kcmil	500-750	YA39A-	YS39A-	4



PAT81K2U05A2



PAT4PC834LI

* Same number of recommended crimps for both Standard and Expanded wire ranges

** Class B - Concentric, Compressed, or Compact



The following list of connector types can accommodate a range of conductors when crimped using the 4-POINT® (81K or 4PC) family of tools:



EXPANDED RANGES

COPPER CONNECTORS

Nom Flex Wire Size	Copper Conductor (Flex Only)							
	Standard Barrel				Long Barrel			
	Expanded Range	Terminal	Splice	# of Crimps	Expanded Range	Terminal	Splice	# of Crimps
#8 AWG	#8 AWG	YAV8CL-	YSV8CL-	1	#8 AWG	YAV8C-	YSV8C-	1
#6 AWG	#6 AWG	YAV6CL-	YSV6CL-	1	#6 AWG	YAV6C-	YSV6C-	1
#4 AWG	#6 - #4 AWG	YAV4CL-	YSV4CL-	1	#6 - #4 AWG	YAV4C-	YSV4C-	1
#2 AWG	#6 - #2 AWG	YAV2CL-	YSV2CL-	1	#6 - #2 AWG	YAV2C-	YSV2C-	1
#1 AWG	#4 - #1 AWG	YAV1CL-	YSV1CL-	1	#4 - #1 AWG	YAV1C-	YSV1C-	1
1/0 AWG	#4 - 1/0 AWG	YAV25L-	YSV25L-	1	#4 - 1/0 AWG	YAV25-	YSV25-	2
2/0 AWG	#2 - 2/0 AWG	YAV26L-	YSV26L-	1	#4 - 2/0 AWG	YAV26-	YSV26-	2
3/0 AWG	#1 - 3/0 AWG	YAV27L-	YSV27L-	1	#2 - 3/0 AWG	YAV27-	YSV27-	2
4/0 AWG	1/0 - 4/0 AWG	YAV28L-	YSV28L-	1	#1 - 4/0 AWG	YAV28-	YSV28-	2
250 kcmil	3/0 AWG - 250 kcmil	YAV29L-	YS29L-	1	1/0 AWG - 250 kcmil	YAV29-	YS29-	2
300 kcmil	4/0 AWG - 313.1 kcmil	YA32L-	YS32L-	1	2/0 AWG - 313.1 kcmil	YA32-	YS32-	2
350 kcmil	262.2 - 373.7 kcmil	YA34L-	YS34L-	1	3/0 AWG - 373.7 kcmil	YA34-	YS34-	2
450 kcmil	373.7 - 444.4 kcmil	YA36L-	YS36L-	1	262.2 - 444.4 kcmil	YA36-	YS36-	2
450 kcmil	262.2 - 444.4 kcmil	YA36L-	YS36L-	2				
500 kcmil	444.4 - 535.3 kcmil	YA38L-	YS38L-	1	373.7 - 535.3 kcmil	YA38-	YS38-	2
500 kcmil	373.7 - 535.3 kcmil	YA38L-	YS38L-	2				
600 kcmil	373.7 - 600 kcmil	YA39L-	YS39L-	2	262.2 - 600 kcmil	YA39-	YS39-	3
650 kcmil	444.4 - 646 kcmil	YA40L-	YS40L-	2	444.4 - 646 kcmil	YA40-	YS40-	3
750 kcmil	750.0 - 777.7 kcmil	YA44L-	YS44L-	2	646.0 - 777.7 kcmil	YA44-	YS44-	3



PAT81K2U05A2



PAT4PC834LI

TYPES YA-L, YA-L-TC

HYLUG™

Uninsulated Copper Compression Terminal
UL Listed 90° C, Up to 35 kV ♦

45° and 90° angles available. Please contact Customer Service to order:
1-800-346-4175

Features & Benefits

- Inspection window allows for visual verification that the wire has been fully inserted prior to crimping the lug; not recommended in highly corrosive environments as the wire in the barrel is exposed to corrosive elements when installed
- Barrel is designed with an internal chamfer at the wire entry to ensure smooth insertion of the wire, preventing possible damaging of the strands
- Short/Standard length barrel is recommended for installations with limited space requirements
- 45° and 90° angular lugs are available; please contact Customer Service
- Electro-tin plated unless otherwise specified to reduce galvanic corrosion (bimetallic) and resist corrosive elements
- Connectors are clearly marked with stamping and barrel color coding
- BURNDY certifies its products using the BURNDY Engineered System and select other crimp tool manufacturers in accordance with one or more of the UL categories in order to obtain a UL Listing
- Terminals and splices accommodating code wire: Accommodates Code Class B (Concentric, Compressed, Compact) and Class C wire

Accessories

- Hardware - Section F
- PENETROX™ Oxide Inhibitor - Section F
- Heat and Cold Shrink Tubing - Section D
- WIREMIKE™ Wire Micrometer - Section F
- Wire Management (Cable Ties) - Section G

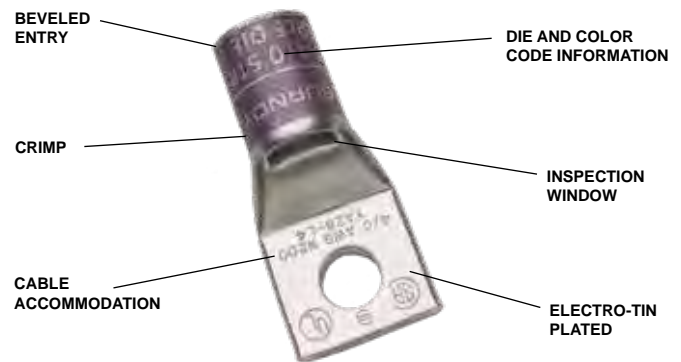

NOTE: Field bending straight lugs to achieve an angular connection will void UL Listing / CSA Certifications and BURNDY will not be liable for the connection.

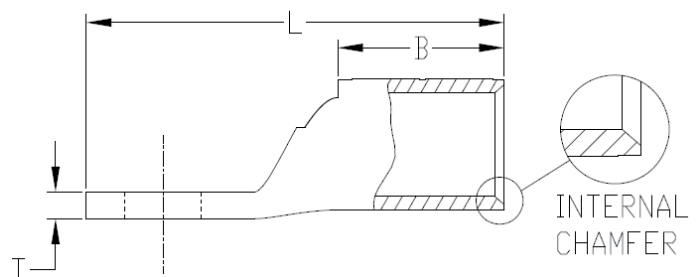
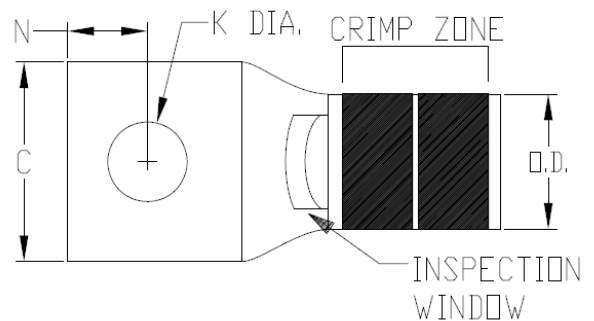

Compression Connections

Copper Compression — Terminal — Code — One Hole
Standard Barrel with Inspection Window

TYPES YA-L, YA-L-TC (Continued)

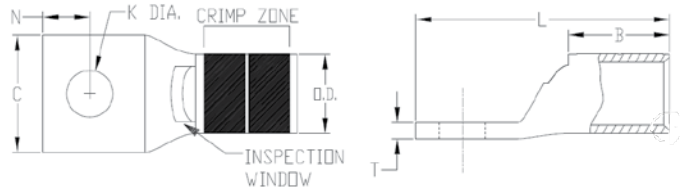

▲ See Copper Code Standard Barrel Terminal Tooling Tables in this section for complete tool and die listing information.

Catalog Number	Conductor			Color Code	Die Index	Stud Hole Size	Figure Dimensions								Wire Strip Length
	Code	Flex	MM ² ***				Stud Hole Diameter (K)	Outside Diameter (OD)	Barrel Length (B)	Pad Width (C)	Overall Length (L)	Hole Spacing (E & F)	Hole Offset (N)	Pad Thickness (T)	
YAV10BOX	#14-#10 AWG #12-#10 Sol		6	—	—	#8-#10	0.23	0.21	0.40	0.38	0.97	—	0.20	0.06	7/16"
YAV10T2BOX						5/16	0.34	0.21	0.39	0.53	1.13	—	0.28	0.04	7/16"
YAV10T3BOX						1/4	0.28	0.21	0.41	0.45	1.10	—	0.24	0.05	7/16"
YAV10T4BOX						3/8	0.40	0.21	0.45	0.55	1.17	—	0.29	0.04	
YA8CLBOX	#8 AWG #8 G,H,I,K,M DLO		10	Red	49	#8-#10	0.21	0.27	0.44	0.41	1.16	—	0.22	0.08	7/16"
YA8CL1BOX						1/4	0.27	0.27	0.44	0.44	1.26	—	0.25	0.08	
YA8CL2BOX						5/16	0.33	0.27	0.44	0.52	1.38	—	0.34	0.06	
YA8CL3BOX						3/8	0.40	0.27	0.44	0.58	1.51	—	0.41	0.06	
YA8CL4BOX						1/2	0.53	0.27	0.44	0.71	1.76	—	0.53	0.05	
YA6CL1BOX	#6 AWG #6 Sol.		—	Blue	7 or 34	#8-#10	0.20	0.29	0.54	0.41	1.27	—	0.22	0.09	9/16
YA6CLBOX						1/4	0.27	0.29	0.54	0.45	1.45	—	0.31	0.08	
YA6CL3BOX						5/16	0.33	0.29	0.54	0.52	1.52	—	0.34	0.07	
YA6CL4BOX						3/8	0.41	0.29	0.54	0.63	1.62	—	0.41	0.06	
YA6CL6						1/2	0.53	0.29	0.54	0.75	1.87	—	0.53	0.12	
YA5CL						#5 AWG					1/4	0.27	0.30	0.81	
YA4CL1BOX	#4 AWG		—	Gray	8	#8-#10	0.21	0.34	0.81	0.50	1.58	—	0.25	0.09	7/8
YA4CLBOX						1/4	0.27	0.34	0.81	0.50	1.74	—	0.31	0.09	
YA4CL3BOX						5/16	0.34	0.34	0.81	0.50	1.79	—	0.41	0.08	
YA4CL4BOX						3/8	0.40	0.34	0.81	0.58	1.92	—	0.41	0.09	
YA4CL6BOX						1/2	0.53	0.34	0.81	0.71	2.20	—	0.53	0.06	
YA3CL	#3 AWG #2 Sol		25	White	9	5/16	0.33	0.38	0.88	0.55	1.88	—	0.34	0.09	15/16
YA2CL2BOX	#2 AWG		35	Brown	10	1/4	0.27	0.42	0.88	0.61	1.88	—	0.31	0.11	15/16
YA2CLBOX						5/16	0.33	0.42	0.88	0.61	1.93	—	0.34	0.11	
YA2CL4BOX						3/8	0.40	0.42	0.88	0.61	2.06	—	0.41	0.11	
YA2CL6BOX						1/2	0.53	0.42	0.88	0.73	2.32	—	0.53	0.09	
YA1CL2	#1 AWG		50	Green	11 or 375	1/4	0.27	0.46	0.88	0.68	1.81	—	0.25	0.10	15/16
YA1CLBOX						5/16	0.33	0.46	0.88	0.68	1.94	—	0.34	0.10	
YA1CL4BOX						3/8	0.40	0.46	0.88	0.68	2.06	—	0.41	0.10	
YA1CL6BOX						1/2	0.53	0.46	0.88	0.73	2.37	—	0.53	0.09	

*** The MM² conductor sizes listed are the recommendations for Class 2 conductor

◆ For applications greater than 2000 Volts consult cable manufacturer for voltage stress relief instructions.

Notes: All dimensions shown are for reference only.

Field bending straight lugs to achieve an angular connection will void UL Listing / CSA Certifications and BURNDY will not be liable for the connection.

TYPES YA-L, YA-L-TC (Continued)

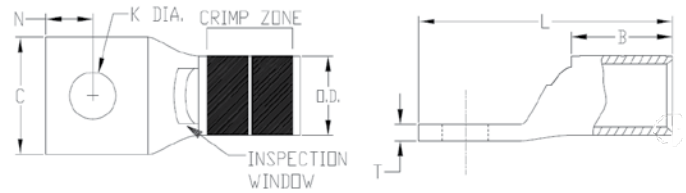

▲ See Copper Code Standard Barrel Terminal Tooling Tables in this section for complete tool and die listing information.

Catalog Number	Conductor			Color Code	Die Index	Stud Hole Size	Figure Dimensions							Wire Strip Length	
	Code	Flex	MM ² ***				Stud Hole Diameter (K)	Outside Diameter (OD)	Barrel Length (B)	Pad Width (C)	Overall Length (L)	Hole Spacing (E & F)	Hole Offset (N)		Pad Thickness (T)
YA25L2BOX	1/0 AWG	—	—	Pink	12	1/4	0.27	0.51	0.88	0.75	1.84	—	0.25	0.12	15/16
YA25LBOX						5/16	0.33	0.51	0.88	0.75	1.96	—	0.34	0.12	
YA25L4BOX						3/8	0.41	0.51	0.88	0.75	2.09	—	0.41	0.12	
YA25L6						1/2	0.53	0.51	0.88	0.75	2.34	—	0.53	0.12	
YA26L2BOX	2/0 AWG	—	70	Black	13	1/4	0.27	0.56	0.94	0.83	1.94	—	0.25	0.12	1
YA26L3						5/16	0.33	0.56	0.94	0.83	2.06	—	0.34	0.12	
YA26LBOX						3/8	0.40	0.56	0.94	0.83	2.19	—	0.41	0.12	
YA26L6BOX						1/2	0.53	0.56	0.94	0.83	2.44	—	0.53	0.12	
YA26L60						3/4	0.81	0.56	0.94	1.02	2.96	—	0.75	0.10	
YA27L3	3/0 AWG	—	—	Orange	14	5/16	0.33	0.62	1.00	0.91	2.16	—	0.34	0.13	1-1/16
YA27L4BOX						3/8	0.40	0.62	1.00	0.91	2.29	—	0.41	0.13	
YA27LBOX						1/2	0.53	0.62	1.00	0.91	2.54	—	0.53	0.13	
YA28L2	4/0 AWG	—	—	Purple	15	1/4	0.27	0.69	0.88	1.02	1.96	—	0.25	0.14	1-1/8
YA28L3						5/16	0.33	0.69	0.88	1.02	2.08	—	0.34	0.14	
YA28L4BOX						3/8	0.40	0.69	0.88	1.02	2.21	—	0.41	0.14	1-1/8
YA28LBOX						1/2	0.53	0.69	0.88	1.02	2.46	—	0.53	0.14	
YA28L56						3/4	0.81	0.69	0.88	1.05	2.90	—	0.75	0.13	
YA29L2	250 kcmil	—	—	Yellow	16	1/4	0.27	0.75	1.06	1.11	2.17	—	0.25	0.16	1-1/8
YA29L4						3/8	0.40	0.75	1.06	1.11	2.42	—	0.41	0.16	
YA29L7						5/16	0.33	0.75	1.06	1.11	2.30	—	0.34	0.16	
YA29LBOX						1/2	0.53	0.75	1.06	1.11	2.67	—	0.53	0.16	
YA29LTC78						7/8	0.94	0.75	1.06	1.11	3.36	—	0.88	0.14	
YA30L1	300 kcmil	—	150	White	17	5/16	0.33	0.81	1.03	1.20	2.31	—	0.34	0.16	1-1/16
YA30L24						3/8	0.40	0.81	1.03	1.20	2.44	—	0.41	0.16	
YA30L						1/2	0.53	0.81	1.03	1.20	2.69	—	0.53	0.16	
YA30LN						1/2	0.56	0.81	1.03	1.20	2.87	—	0.63	0.16	1
YA30L7						5/8	0.69	0.81	1.03	1.20	2.94	—	0.66	0.16	1-1/16
YA30L28						3/4	0.81	0.81	1.03	1.20	3.12	—	0.75	0.16	
YA30L27						7/8	1.20	0.81	1.03	1.20	3.37	—	0.88	0.16	

*** The MM² conductor sizes listed are the recommendations for Class 2 conductor

◆ For applications greater than 2000 Volts consult cable manufacturer for voltage stress relief instructions.

Notes: All dimensions shown are for reference only.

Field bending straight lugs to achieve an angular connection will void UL Listing / CSA Certifications and BURNDY will not be liable for the connection.

Compression Connections

Copper Compression — Terminal — Code — One Hole
Standard Barrel with Inspection Window

TYPES YA-L, YA-L-TC (Continued)

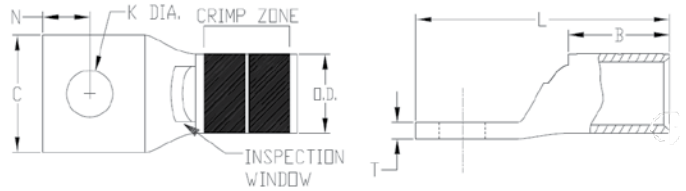

▲ See Copper Code Standard Barrel Terminal Tooling Tables in this section for complete tool and die listing information.

Catalog Number	Conductor			Color Code	Die Index	Stud Hole Size	Figure Dimensions								Wire Strip Length
	AWG	Flex	MM ² ***				Stud Hole Diameter (K)	Outside Diameter (OD)	Barrel Length (B)	Pad Width (C)	Overall Length (L)	Hole Spacing (E) & (F)	Hole Offset (N)	Pad Thickness (T)	
YA31L11	350 kcmil	—	185	Red	18	3/8	0.40	0.88	1.06	1.29	2.50	—	0.41	0.18	1-1/8
YA31L						1/2	0.53	0.88	1.06	1.29	2.75	—	0.53	0.18	
YA31L7						5/8	0.69	0.88	1.06	1.29	3.00	—	0.66	0.18	
YA31L36						7/8	0.94	0.88	1.06	1.29	4.02	—	1.19	0.18	
YA32L14	400 kcmil	—	—	Blue	19	3/8	0.40	0.95	1.19	1.40	2.68	—	0.41	0.19	1-1/4
YA32LN						1/2	0.56	0.88	1.19	1.40	3.12	—	0.63	0.19	
YA32L1						1/2	0.53	0.95	1.19	1.40	2.93	—	0.53	0.19	
YA32L						5/8	0.69	0.95	1.19	1.40	3.18	—	0.67	0.19	
YA32LTC78						7/8	0.94	0.95	1.19	1.40	3.62	—	0.88	0.19	
YA33L	450 kcmil	—	—	Gray	326	5/8	0.69	1.01	1.50	1.48	3.57	—	0.66	0.21	1-9/16
YA34L37	500 kcmil	—	240	Brown	20	3/8	0.40	1.06	1.27	1.55	2.87	—	0.41	0.23	1-7/16
YA34L6						1/2	0.53	1.06	1.27	1.55	3.12	—	0.53	0.23	
YA34L						5/8	0.69	1.06	1.27	1.55	3.37	—	0.66	0.23	
YA34L8						3/4	0.81	1.06	1.27	1.55	3.55	—	0.75	0.23	
YA34L9						7/8	0.94	1.06	1.27	1.55	3.80	—	0.88	0.23	
YA34L20						1	1.07	1.06	1.27	1.55	4.05	—	1.00	0.23	
YA36L11	600 kcmil	—	300	Green	22 or 472	1/2	0.53	1.19	1.38	1.74	3.29	—	0.53	0.27	1-3/4
YA36L						5/8	0.69	1.19	1.38	1.74	3.54	—	0.66	0.27	
YA36LTC78						7/8	0.94	1.19	1.38	1.74	3.97	—	0.88	0.27	
YA37L	650 kcmil	—	—	Orange	23	5/8	0.69	1.23	1.39	1.80	3.57	—	0.66	0.27	1-15/16
YA37L1						3/4	0.81	1.23	1.39	1.80	3.76	—	0.75	0.27	
YA38L	700 kcmil	—	—	Pink	400	5/8	0.69	1.25	1.45	1.84	3.66	—	0.66	0.27	1-15/16
YA39L6	750 kcmil	—	—	Black	24	1/2	0.53	1.30	1.42	1.91	3.41	—	0.53	0.27	1-15/16
YA39L						5/8	0.69	1.30	1.42	1.91	3.57	—	0.66	0.27	
YA39L2						7/8	0.94	1.30	1.42	1.91	4.10	—	0.88	0.27	
YA39L9						1-1/4	1.31	1.30	1.42	1.91	4.85	—	1.25	0.27	
YA40L	800 kcmil	—	400	Orange	25	5/8	0.69	1.35	1.42	1.98	3.81	—	0.66	0.30	1-15/16
YA41L	850 kcmil	—	—	Gold	26	5/8	0.69	1.38	1.88	2.01	4.15	—	0.66	0.31	1-15/16
YA44L2	1000 kcmil	—	500	White	27	1/2	0.56	1.50	1.65	2.19	3.98	—	0.63	0.33	1-15/16
YA44L						5/8	0.69	1.50	1.65	2.19	4.04	—	0.66	0.33	
YA44L23						1	1.06	1.50	1.65	2.19	4.73	—	1.00	0.33	

*** The MM² conductor sizes listed are the recommendations for Class 2 conductor

◆ For applications greater than 2000 Volts consult cable manufacturer for voltage stress relief instructions.

Notes: All dimensions shown are for reference only.

Field bending straight lugs to achieve an angular connection will void UL Listing / CSA Certifications and BURNDY will not be liable for the connection.

TYPES YA-L, YA-L-TC (Continued)

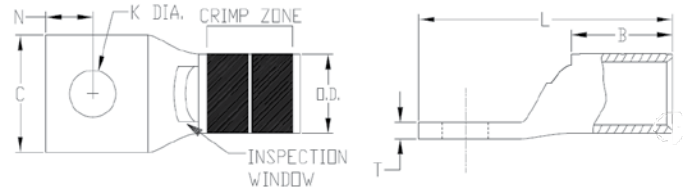

▲ See Copper Code Standard Barrel Terminal Tooling Tables in this section for complete tool and die listing information.

Catalog Number	Conductor			Color Code	Die Index	Stud Hole Size	Figure Dimensions								Wire Strip Length
	AWG	Flex	MM ² ***				Stud Hole Diameter (K)	Outside Diameter (OD)	Barrel Length (B)	Pad Width (C)	Overall Length (L)	Hole Spacing (E) & (F)	Hole Offset (N)	Pad Thickness (T)	
YA45L	1250 kcmil	—	—	Yellow	29	3/4	0.81	1.69	2.00	2.46	4.68	—	0.75	0.38	2-1/16
YA453LBOX	1300 kcmil	—	—	Orange	30	3/4	0.81	1.74	2.00	2.53	4.71	—	0.75	0.39	2-1/16
YA46L	1500 kcmil	—	—	Green	31	3/4	0.81	1.84	2.00	2.69	4.78	—	0.75	0.40	2-1/16
YA48L	2000 kcmil	—	1000	Brown	34	3/4	0.81	2.13	2.25	3.10	5.19	—	0.75	0.46	2-3/8

*** The MM² conductor sizes listed are the recommendations for Class 2 conductor

◆ For applications greater than 2000 Volts consult cable manufacturer for voltage stress relief instructions.

Notes: All dimensions shown are for reference only.

Field bending straight lugs to achieve an angular connection will void UL Listing / CSA Certifications and BURNDY will not be liable for the connection.

Compression Connections

Copper Compression — Terminal— Code — One Hole
Narrow Tongue, Standard Barrel with Inspection Window

TYPE YA-L-NT

HYLUG™

Uninsulated Copper Compression Narrow Tongue Terminal
UL Listed 90° C, Up to 35 kV ♦

45° and 90° angles available. Please contact Customer Service to order:
1-800-346-4175

Features & Benefits

- Inspection window allows for visual verification that the wire has been fully inserted prior to crimping the lug; not recommended in highly corrosive environments as the wire in the barrel is exposed to corrosive elements when installed
- Narrow tongue/tang is designed for limited space applications
- Barrel is designed with an internal chamfer at the wire entry to ensure smooth insertion of the wire, preventing possible damaging of the strands
- Short/Standard length barrel is recommended for installations with limited space requirements
- 45° and 90° angular lugs are available; please contact Customer Service
- Electro-tin plated unless otherwise specified to reduce galvanic corrosion (bimetallic) and resist corrosive elements
- Connectors are clearly marked with stamping and barrel color coding
- BURNDY certifies its products using the BURNDY Engineered System and select other crimp tool manufacturers in accordance with one or more of the UL categories in order to obtain a UL Listing
- Terminals and splices accommodating code wire: Accommodates Code Class B (Concentric, Compressed, Compact) and Class C wire

Accessories

- Hardware - Section F
- PENETROX™ Oxide Inhibitor - Section F
- Heat and Cold Shrink Tubing - Section D
- WIREMIKE™ Wire Micrometer - Section F
- Wire Management (Cable Ties) - Section G

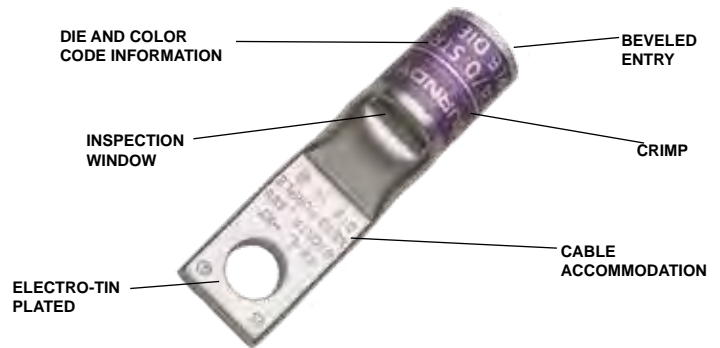

NOTE: Field bending straight lugs to achieve an angular connection will void UL Listing / CSA Certifications and BURNDY will not be liable for the connection.

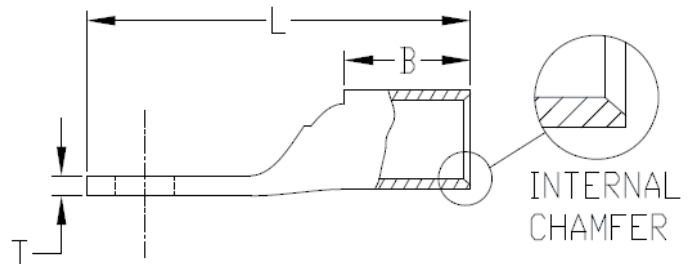
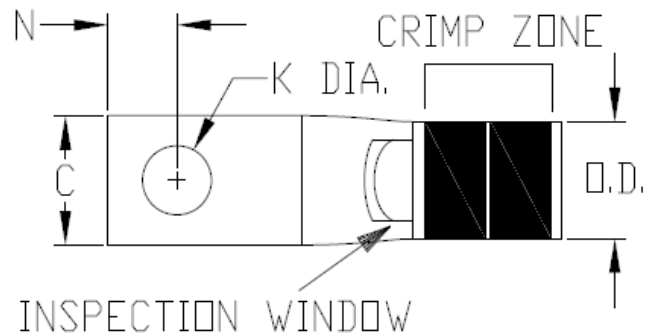

TYPE YA-L,-NT (Continued)

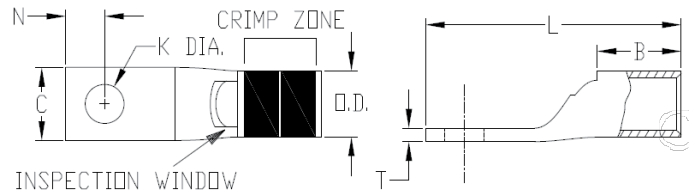

▲ See Copper Code Standard Barrel Terminal Tooling Tables in this section for complete tool and die listing information.

Catalog Number	Conductor			Color Code	Die Index	Stud Size	Figure Dimensions								Wire Strip Length
	Code	Flex	Metric MM ² ***				Stud Hole Diameter (K)	Outside Diameter (OD)	Barrel Length (B)	Pad Width (C)	Overall Length (L)	Hole Spacing (E) & (F)	Hole Offset (N)	Pad Thickness (T)	
YA8CLNT6	#8 AWG	#8 G,H,I,K,M DLO	10	Red	49	#6	0.15	0.27	0.44	0.29	1.08	—	0.19	0.09	1/2
YA8CLNT8						#8	0.18	0.27	0.44	0.33	1.18	—	0.22	0.09	
YA6CLNT6	#6 AWG #6 Sol.	—	—	Blue	7	#6	0.15	0.29	0.54	0.29	1.17	—	0.19	0.09	7/8
YA4CLNT10	#4 AWG	—	—	Gray	8	#10	0.20	0.34	0.81	0.40	1.73	—	0.31	0.09	7/8
YA3CLNT14	#3 AWG #2 Sol.	—	25	White	9	1/4	0.27	0.38	0.88	0.41	1.82	—	0.31	0.08	15/16
YA3CLNT516						5/16	0.33	0.38	0.88	0.49	1.80	—	0.25	0.08	
YA2CLNT10	#2 AWG	—	35	Brown	10	#10	0.20	0.42	0.88	0.48	1.80	—	0.25	0.11	15/16
YA2CLNT14						1/4	0.27	0.42	0.88	0.48	1.80	—	0.25	0.11	
YA2CLNT516						5/16	0.33	0.42	0.88	0.49	1.82	—	0.25	0.11	
YA1CLNT10	#1 AWG	—	50	Green	11	#10	0.20	0.46	0.88	0.50	2.23	—	0.25	0.10	15/16
YA1CLNT14						1/4	0.27	0.46	0.88	0.50	2.23	—	0.25	0.10	
YA25LNT10	1/0 AWG	—	—	Pink	12	#10	0.20	0.51	0.88	0.62	2.28	—	0.33	0.12	15/16
YA25LNT14						1/4	0.27	0.51	0.88	0.48	1.93	—	0.31	0.12	
YA25LNT516						5/16	0.33	0.51	0.88	0.62	2.28	—	0.33	0.12	
YA25LNT38						3/8	0.41	0.51	0.88	0.62	2.18	—	0.41	0.12	
YA26LNT10	2/0 AWG	—	70	Black	13	#10	0.20	0.56	0.94	0.62	2.62	—	0.33	0.13	1
YA26LNT14						1/4	0.27	0.56	0.94	0.48	2.02	—	0.25	0.12	
YA26LNT516						5/16	0.33	0.56	0.94	0.62	2.62	—	0.33	0.13	
YA26LNT38						3/8	0.41	0.56	0.94	0.72	2.48	—	0.38	0.12	
YA27LNT14	3/0 AWG	—	—	Orange	14	1/4	0.27	0.62	1.00	0.76	2.10	—	0.31	0.13	1-1/16
YA27LNT516						5/16	0.33	0.62	1.00	0.60	2.17	—	0.34	0.12	
YA27LNT38						3/8	0.41	0.62	1.00	0.76	2.73	—	0.41	0.12	
YA28LNT14	4/0 AWG	—	—	Purple	15	1/4	0.27	0.69	0.88	0.76	2.60	—	0.31	0.14	1-1/8
YA28LNT516						5/16	0.33	0.69	0.88	0.70	2.09	—	0.34	0.14	
YA28LNT38						3/8	0.41	0.69	0.88	0.76	2.67	—	0.41	0.14	

*** The MM² conductor sizes listed are the recommendations for Class 2 conductor

◆ For applications greater than 2000 Volts consult cable manufacturer for voltage stress relief instructions.

Notes: All dimensions shown are for reference only.

Field bending straight lugs to achieve an angular connection will void UL Listing / CSA Certifications and BURNDY will not be liable for the connection.

Compression Connections

Copper Compression — Terminal— Code — One Hole
Narrow Tongue, Standard Barrel with Inspection Window

TYPE YA-L-NT (Continued)

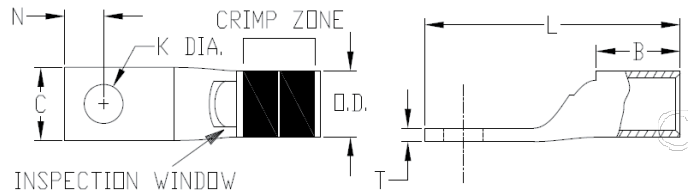

▲ See Copper Code Standard Barrel Terminal Tooling Tables in this section for complete tool and die listing information.

Catalog Number	Conductor			Color Code	Die Index	Stud Size	Figure Dimensions								Wire Strip Length
	Code	Flex	Metric MM ² ***				Stud Hole Diameter (K)	Outside Diameter (OD)	Barrel Length (B)	Pad Width (C)	Overall Length (L)	Hole Spacing (E) & (F)	Hole Offset (N)	Pad Thickness (T)	
YA29LENT516	250 kcmil	—	—	Yellow	16	5/16	0.33	0.75	1.06	0.76	2.49	—	0.34	0.16	1-1/8
YA29LENT38						3/8	0.41	0.75	1.06	0.76	2.96	—	0.41	0.16	
YA29LNT38						3/8	0.41	0.75	1.06	0.96	2.96	—	0.41	0.16	
YA30LNT14	300 kcmil	—	150	White	17	1/4	0.27	0.81	1.03	0.83	2.26	—	0.31	0.16	1-1/8
YA30LNT38						3/8	0.41	0.81	1.03	0.96	2.97	—	0.41	0.16	
YA31LNT38	350 kcmil	—	185	Red	18	3/8	0.41	0.88	1.06	0.96	3.31	—	0.41	0.18	1-1/8
YA31LNT12						1/2	0.53	0.88	1.06	0.88	2.75	—	0.53	0.18	
YA32LNT38	400 kcmil	—	—	Blue	19	3/8	0.41	0.95	1.19	0.96	3.21	—	0.41	0.20	1-1/4
YA32LNT12						1/2	0.53	0.95	1.19	0.96	3.21	—	0.53	0.19	
YA34LNT38	500 kcmil	—	240	Brown	20	3/8	0.41	1.06	1.27	0.96	3.65	—	0.41	0.23	1-7/16
YA34LNT12						1/2	0.53	1.06	1.27	0.96	3.65	—	0.53	0.23	
YA36LNT38	600 kcmil	—	300	Green	22	3/8	0.41	1.18	1.38	1.12	4.09	—	0.50	0.27	1-3/4
YA36LNT12						1/2	0.53	1.19	1.38	1.00	3.29	—	0.53	0.27	
YA39LNT38	750 kcmil	—	—	Black	24	3/8	0.41	1.30	1.42	1.12	4.24	—	0.50	0.27	1-15/16
YA39LNT12						1/2	0.56	1.30	1.42	1.12	4.24	—	0.53	0.27	
YA39LNT58						5/8	0.69	1.30	1.42	1.30	3.67	—	0.66	0.27	

*** The MM² conductor sizes listed are the recommendations for Class 2 conductor

◆ For applications greater than 2000 Volts consult cable manufacturer for voltage stress relief instructions.

Notes: All dimensions shown are for reference only.

Field bending straight lugs to achieve an angular connection will void UL Listing / CSA Certifications and BURNDY will not be liable for the connection.

TYPES YAV-2TC, YA-2LN, YA-L-2TC-

HYLUG™

Uninsulated Copper Compression Terminal
UL Listed 90° C, Up to 35 kV ◆

45° and 90° angles available. Please contact Customer Service to order:
1-800-346-4175

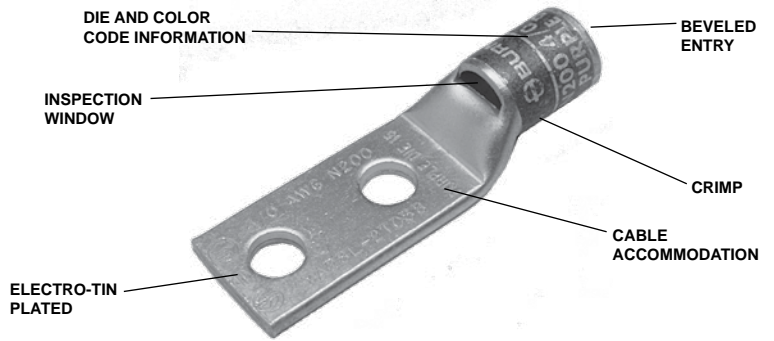

Features & Benefits

- Inspection window allows for visual verification that the wire has been fully inserted prior to crimping the lug
- Barrel is designed with an internal chamfer at the wire entry to ensure smooth insertion of the wire, preventing possible damaging of the strands
- Short/Standard length barrel is recommended for installations with limited space requirements
- Two hole tongue/tang is recommended when space permits as the 2-hole feature minimizes the terminations from loosening or rotating under vibration, movement, or heat cycling
- 45° and 90° angular lugs are available; please contact Customer Service
- Electro-tin plated unless otherwise specified to reduce galvanic corrosion (bimetallic) and resist corrosive elements
- Connectors are clearly marked with stamping and barrel color coding
- BURNDY certifies its products using the BURNDY Engineered System and select other crimp tool manufacturers in accordance with one or more of the UL categories in order to obtain a UL Listing
- Terminals and splices accommodating code wire: Accommodates Code Class B (Concentric, Compressed, Compact) and Class C wire



NOTE: Field bending straight lugs to achieve an angular connection will void UL Listing / CSA Certifications and BURNDY will not be liable for the connection.

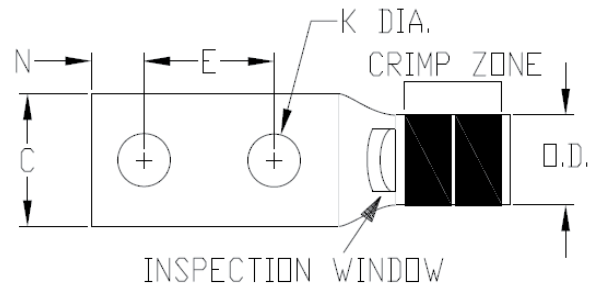

Accessories

- Hardware - Section F
- PENETROX™ Oxide Inhibitor - Section F
- Heat and Cold Shrink Tubing - Section D
- WIREMIKE™ Wire Micrometer - Section F
- Wire Management (Cable Ties) - Section G

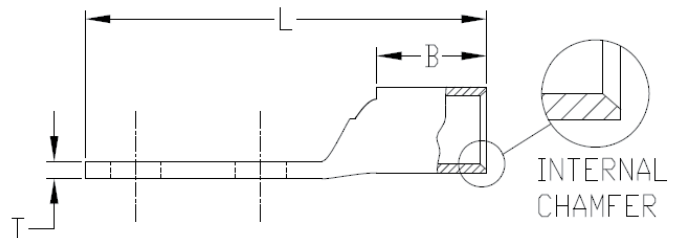

Compression Connections

Copper Compression — Terminal — Code — Two Hole
Standard Barrel — with Inspection Window

TYPES YAV-2TC, YA-2LN, YA-L-2TC- (Continued)

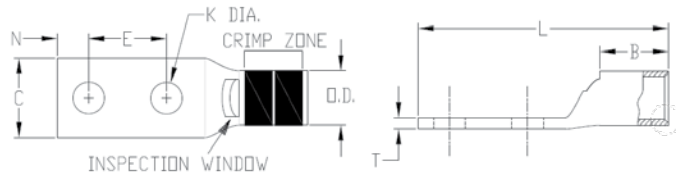

▲ See Copper Code Standard Barrel Terminal Tooling Tables in this section for complete tool and die listing information.

Catalog Number	Conductor			Color Code	Die Index	Stud Size	Figure Dimensions							Wire Strip Length	
	Code	Flex	Metric MM ² ***				Stud Hole Diameter (K)	Outside Diameter (OD)	Barrel Length (B)	Pad Width (C)	Overall Length (L)	Hole Spacing (E & F)	Hole Offset (N)		Pad Thickness (T)
YAV102TC10	14-10 AWG 12-10 Sol.	—	6	—	—	#10	0.21	0.21	0.38	0.36	1.72	5/8	0.25	0.06	7/16
YAV102TC10E2						#10	0.21	0.21	0.38	0.36	1.84	3/4	0.25	0.06	
YAV102TC14						1/4	0.27	0.21	0.38	0.41	1.84	5/8	0.31	0.05	
YAV102TC14E1						1/4	0.27	0.21	0.38	0.41	2.22	1	0.31	0.05	
YAV102TC14E2						1/4	0.27	0.21	0.38	0.41	1.97	3/4	0.31	0.05	
YAV102TC38						3/8	0.39	0.21	0.38	0.56	2.40	1	0.41	0.04	
YA8CL2TC10	8 AWG	#8 G,H,I,K,M DLO	10	Red	49	#10	0.21	0.27	0.44	0.41	1.83	5/8	0.25	0.08	7/16
YA8CL2TC10E2						#10	0.21	0.27	0.44	0.41	1.95	3/4	0.25	0.08	
YA8CL2TC14						1/4	0.27	0.27	0.44	0.44	1.95	5/8	0.31	0.08	
YA8CL2TC14E2						1/4	0.27	0.27	0.44	0.44	2.08	3/4	0.31	0.08	
YA8CL2TC14E1						1/4	0.27	0.27	0.44	0.44	2.33	1	0.31	0.08	
YA8CL2TC38						3/8	0.39	0.27	0.44	0.58	2.52	1	0.41	0.06	
YA8C2LN						1/2	0.56	0.27	0.44	0.83	3.75	1-3/4	0.62	0.12	
YA6C2L51	6 AWG 6 Sol.	—	—	Blue	7 or 374	#10	0.21	0.29	0.54	0.42	1.79	1/2	0.22	0.09	5/8
YA6CL2TC10						#10	0.21	0.29	0.54	0.42	1.94	5/8	0.25	0.09	
YA6C2L52						1/4	0.27	0.29	0.54	0.45	1.88	1/2	0.25	0.08	
YA6CL2TC14E						1/4	0.27	0.29	0.54	0.45	1.94	1/2	0.31	0.08	
YA6C2L						1/4	0.27	0.29	0.54	0.45	2.01	5/8	0.25	0.08	
YA6CL2TC14						1/4	0.27	0.29	0.54	0.45	2.07	5/8	0.31	0.08	
YA6CL2TC14E2						1/4	0.27	0.29	0.54	0.45	2.19	3/4	0.31	0.08	
YA6CL2TC14E1						1/4	0.27	0.29	0.54	0.45	2.44	1	0.31	0.08	
YA6CL2TC516E2						5/16	0.33	0.29	0.54	0.52	2.53	3/4	0.34	0.07	
YA6CL2TC516						5/16	0.33	0.29	0.54	0.52	2.78	1	0.34	0.07	
YA6CL2TC38						3/8	0.39	0.29	0.54	0.58	2.63	1	0.41	0.06	
YA6C2LN						1/2	0.56	0.29	0.54	0.83	4.10	1-3/4	0.62	0.12	
YA5C2L						5 AWG	—	—	Blue	7 or 374	1/4	0.27	0.30	0.81	

*** The MM² conductor sizes listed are the recommendations for Class 2 conductor

◆ For applications greater than 2000 volts consult cable manufacturer for voltage stress relief instructions

Notes: All dimensions shown are for reference only.

Field bending straight lugs to achieve an angular connection will void UL Listing / CSA Certifications and BURNDY will not be liable for the connection.

TYPES YAV-2TC, YA-2LN, YA-L-2TC- (Continued)

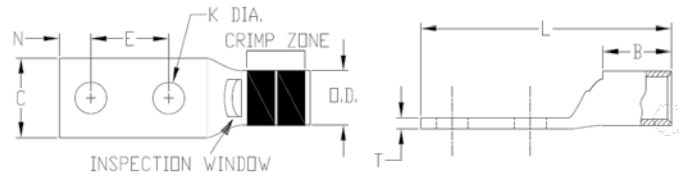

▲ See Copper Code Standard Barrel Terminal Tooling Tables in this section for complete tool and die listing information.

Catalog Number	Conductor			Color Code	Die Index	Stud Size	Figure Dimensions							Wire Strip Length	
	Code	Flex	Metric MM ² ***				Stud Hole Diameter (K)	Outside Diameter (OD)	Barrel Length (B)	Pad Width (C)	Overall Length (L)	Hole Spacing (E) & (F)	Hole Offset (N)		Pad Thickness (T)
YA4C2L	4 AWG	—	—	Gray	8or 346	1/4	0.27	0.34	0.81	0.50	2.30	0.25	0.09	7/8	
YA4CL2TC14						1/4	0.27	0.34	0.81	0.50	2.36	0.31	0.09		0.09
YA4CL2TC14E2						1/4	0.27	0.34	0.81	0.50	2.49	0.31	0.09		0.09
YA4CL2TC14E1						1/4	0.27	0.34	0.81	0.50	2.74	0.31	0.09		0.09
YA4CL2TC516						5/16	0.33	0.34	0.81	0.52	2.80	0.34	0.09		0.09
YA4CL2TC38						3/8	0.39	0.34	0.81	0.58	2.96	0.41	0.08		0.08
YA4C2LN						1/2	0.56	0.34	0.81	0.83	4.14	0.63	0.12		0.12
YA3CL2TC14	3 AWG #2 Sol.	—	25	White	9	1/4	0.27	0.38	0.88	0.55	2.45	5/8	0.31	15/16	
YA3C2L						5/16	0.33	0.38	0.88	0.55	2.64	5/8	0.34		0.09
YA3CL2TC38						3/8	0.39	0.38	0.88	0.58	3.06	1	0.41		0.08
YA2CL2TC14	#2 AWG	—	35	Brown	10	1/4	0.27	0.42	0.88	0.60	2.47	5/8	0.31	15/16	
YA2CL2TC14E2						1/4	0.27	0.42	0.88	0.60	2.60	3/4	0.31		0.11
YA2CL2TC14E1						1/4	0.27	0.42	0.88	0.60	2.85	1	0.31		0.11
YA2C2L						5/16	0.33	0.42	0.88	0.60	2.67	3/4	0.34		0.11
YA2CL2TC516						5/16	0.33	0.42	0.88	0.60	2.91	1	0.34		0.11
YA2CL2TC38						3/8	0.40	0.42	0.88	0.60	3.03	1	0.41		0.11
YA2C2LN						1/2	0.56	0.42	0.88	0.83	4.27	1-3/4	0.63		0.12
YA1CL2TC14	#1 AWG	—	50	Green	11 or 375	1/4	0.27	0.46	0.88	0.68	2.51	5/8	0.31	15/16	
YA1CL2TC14E2						1/4	0.27	0.46	0.88	0.68	2.64	3/4	0.25		0.10
YA1C2L						5/16	0.33	0.46	0.88	0.68	2.82	7/8	0.34		0.10
YA1CL2TC38						3/8	0.40	0.46	0.88	0.68	3.07	1	0.41		0.10
YA1C2LN						1/2	0.56	0.46	0.88	0.83	4.32	1-3/4	0.62		0.12
YA25L2TC14	1/0 AWG	—	—	Pink	12 or 348	1/4	0.27	0.51	0.88	0.75	2.54	5/8	0.31	15/16	
YA25L2TC14E2						1/4	0.27	0.51	0.88	0.75	2.66	3/4	0.31		0.12
YA25L2TC14E1						1/4	0.27	0.51	0.88	0.75	2.91	1	0.31		0.12
YA252L						5/16	0.33	0.51	0.88	0.75	2.85	7/8	0.34		0.12
YA25L2TC38						3/8	0.41	0.51	0.88	0.75	3.10	1	0.41		0.12
YA252LN						1/2	0.56	0.51	0.88	0.83	4.29	1-3/4	0.63		0.11

*** The MM² conductor sizes listed are the recommendations for Class 2 conductor

◆ For applications greater than 2000 volts consult cable manufacturer for voltage stress relief instructions

Notes: All dimensions shown are for reference only.

Field bending straight lugs to achieve an angular connection will void UL Listing / CSA Certifications and BURNDY will not be liable for the connection.

Compression Connections

Copper Compression — Terminal — Code — Two Hole
Standard Barrel — with Inspection Window

TYPES YAV-2TC, YA-2LN, YA-L-2TC- (Continued)

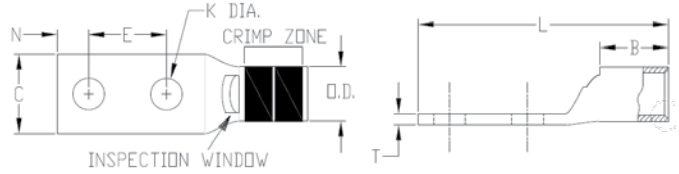

▲ See Copper Code Standard Barrel Terminal Tooling Tables in this section for complete tool and die listing information.

Catalog Number	Conductor			Color Code	Die Index	Stud Size	Figure Dimensions								Wire Strip Length
	Code	Flex	Metric MM ² ***				Stud Hole Diameter (K)	Outside Diameter (OD)	Barrel Length (B)	Pad Width (C)	Overall Length (L)	Hole Spacing (E & F)	Hole Offset (N)	Pad Thickness (T)	
YA26L2TC14	2/0 AWG	—	70	Black	13	1/4	0.27	0.56	0.94	0.83	2.64	5/8	0.31	0.12	1
YA26L2TC14E2						1/4	0.27	0.56	0.94	0.83	2.76	3/4	0.31	0.12	
YA26L2TC14E1						1/4	0.27	0.56	0.94	0.83	3.01	1	0.31	0.12	
YA262L						5/16	0.33	0.56	0.94	0.83	2.95	7/8	0.34	0.12	
YA26L2TC38						3/8	0.40	0.56	0.94	0.83	3.20	1	0.41	0.12	
YA262LN						1/2	0.56	0.56	0.94	0.83	4.39	1-3/4	0.63	0.12	
YA27L2TC14E2	3/0 AWG	—	—	Orange	14	1/4	0.27	0.62	1.00	1.00	2.86	3/4	0.31	0.12	1-1/16
YA27L2TC38						3/8	0.41	0.62	1.00	1.00	3.30	1	0.41	0.12	
YA272LN						1/2	0.56	0.62	1.00	0.91	4.48	1-3/4	0.63	0.13	
YA28L2TC14E2	4/0 AWG	—	—	PURPLE	15	1/4	0.27	0.69	0.88	1.02	2.78	3/4	0.31	0.14	1-1/8
YA28L2TC14E1						1/4	0.27	0.69	0.88	1.02	3.03	1	0.31	0.14	
YA28L2NTC516						5/16	0.33	0.69	0.88	1.02	3.84	1-3/4	0.34	0.14	
YA28L2TC38E2						3/8	0.41	0.69	0.88	1.02	2.97	3/4	0.41	0.14	
YA28L2TC38						3/8	0.41	0.69	0.88	1.02	3.22	1	0.41	0.14	
YA282LN						1/2	0.56	0.69	0.88	1.02	4.41	1-3/4	0.63	0.14	
YA29L2TC38	250 kcmil	—	—	Yellow	16	3/8	0.41	0.75	1.06	1.10	3.43	1	0.41	0.16	1-1/8
YA292LN						1/2	0.56	0.75	1.06	1.10	4.62	1-3/4"	0.63	0.16	
YA30L2TC38	300 kcmil	—	150	White	17 or 298	3/8	0.41	0.81	1.03	1.20	3.45	1	0.41	0.16	1
YA302LN						1/2	0.56	0.81	1.03	1.20	4.63	1-3/4	0.63	0.16	
YA31L2TC14E2	350 kcmil	—	185	Red	18 or 324	1/4	0.27	0.88	1.06	1.29	3.07	3/4	0.31	0.18	1-1/8
YA31L2NTC516						5/16	0.33	0.88	1.06	1.29	4.13	1-3/4	0.34	0.18	
YA31L2TC38						3/8	0.40	0.88	1.06	1.29	3.51	1	0.41	0.18	
YA31L2TC12						1/2	0.52	0.88	1.06	1.29	4.01	1-1/4	0.53	0.18	
YA312LN						1/2	0.56	0.88	1.06	1.29	4.70	1-3/4	0.62	0.18	
YA322L	400 kcmil	—	—	Blue	19 or 470	3/8	0.40	0.95	1.19	1.40	3.75	1	0.41	0.19	1-1/4
YA32L2TC38						3/8	0.40	0.95	1.19	1.40	3.69	1	0.41	0.19	
YA32L2TC38E5						3/8	0.40	0.95	1.19	1.40	3.75	1-1/16	0.41	0.19	
YA322LN						1/2	0.56	0.95	1.19	1.40	4.88	1-3/4	0.63	0.19	

*** The MM² conductor sizes listed are the recommendations for Class 2 conductor

◆ For applications greater than 2000 volts consult cable manufacturer for voltage stress relief instructions

Notes: All dimensions shown are for reference only.

Field bending straight lugs to achieve an angular connection will void UL Listing / CSA Certifications and BURNDY will not be liable for the connection.

TYPES YAV-2TC, YA-2LN, YA-L-2TC- (Continued)

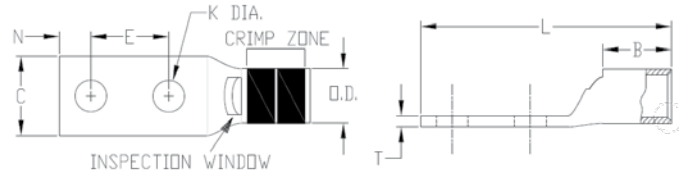

▲ See Copper Code Standard Barrel Terminal Tooling Tables in this section for complete tool and die listing information.

Catalog Number	Conductor			Color Code	Die Index	Stud Size	Figure Dimensions							Wire Strip Length	
	Code	Flex	Metric MM ² ***				Stud Hole Diameter (K)	Outside Diameter (OD)	Barrel Length (B)	Pad Width (C)	Overall Length (L)	Hole Spacing (E & F)	Hole Offset (N)		Pad Thickness (T)
YA34L2TC14E2	500 kcmil	—	240	Brown	20 or 299	1/4	0.27	1.06	1.27	1.55	3.44	3/4	0.31	0.23	1-7/16
YA342L						3/8	0.40	1.06	1.27	1.55	3.94	1	0.41	0.23	
YA34L2TC38						3/8	0.41	1.06	1.27	1.55	3.88	1	0.41	0.23	
YA34L2TC12						1/2	0.52	1.06	1.27	1.55	4.38	1-1/4	0.53	0.23	
YA342LN						1/2	0.56	1.06	1.27	1.55	5.06	1-3/4	0.63	0.23	
YA352L	550 kcmil	—	—	Yellow	21	3/8	0.44	1.13	1.69	1.65	4.64	1-1/8	0.50	0.25	1-3/4
YA352LN						1/2	0.56	1.13	1.69	1.65	5.51	1-3/4	0.63	0.25	
YA36L2TC38	600 kcmil	—	300	Green	22 or 472	3/8	0.40	1.19	1.38	1.74	4.23	1	0.50	0.27	1-3/4
YA362LN						1/2	0.56	1.19	1.38	1.74	5.23	1-3/4	0.63	0.27	
YA372L	650 kcmil	—	—	Orange	23	3/8	0.44	1.23	1.39	1.80	4.40	1-1/8	0.50	0.27	1-15/16
YA372LN						1/2	0.56	1.23	1.39	1.80	5.27	1-3/4	0.63	0.27	
YA38L2TC38	700 kcmil	—	—	Pink	400	3/8	0.40	1.25	1.45	1.84	4.35	1	0.50	0.27	1-15/16
YA382L						3/8	0.44	1.25	1.45	1.84	4.48	1-1/8	0.50	0.27	
YA38L2TC12						1/2	0.52	1.25	1.45	1.84	4.67	1-1/2	0.53	0.27	
YA382LN						1/2	0.56	1.25	1.45	1.84	5.35	1-3/4	0.63	0.27	
YA39L2TC38	750 kcmil	—	—	Black	24	3/8	0.40	1.30	1.42	1.91	4.36	1	0.50	0.27	1-15/16
YA392L						3/8	0.44	1.30	1.42	1.91	4.48	1-1/8	0.50	0.27	
YA39L2TC12E3						1/2	0.52	1.30	1.42	1.91	4.92	1-1/2	0.53	0.27	
YA392LN						1/2	0.56	1.30	1.42	1.91	5.36	1-3/4	0.63	0.27	
YA39L2TC58						5/8	0.69	1.30	1.42	1.91	5.17	1-1/2	0.66	0.27	
YA40L2TC38	800 kcmil	—	400	Orange	25	3/8	0.40	1.35	1.42	1.98	4.37	1	0.50	0.30	1-15/16
YA402L						3/8	0.44	1.35	1.42	1.98	4.50	1-1/8	0.50	0.30	
YA402LN						1/2	0.56	1.35	1.42	1.98	5.38	1-3/4	0.63	0.30	
YA412L	850 kcmil	—	—	Gold	26	3/8	0.44	1.38	1.88	2.01	4.97	1-1/8	0.50	0.31	1-15/16
YA442L	1000 kcmil	—	500	White	27	1/2	0.56	1.50	1.65	2.19	5.24	1-1/4	0.63	0.33	1-15/16
YA44L2TC12						1/2	0.52	1.50	1.65	2.19	5.05	1-1/4	0.53	0.33	
YA442LN						1/2	0.56	1.50	1.65	2.19	5.74	1-3/4	0.63	0.33	

*** The MM² conductor sizes listed are the recommendations for Class 2 conductor

◆ For applications greater than 2000 volts consult cable manufacturer for voltage stress relief instructions

Notes: All dimensions shown are for reference only.

Field bending straight lugs to achieve an angular connection will void UL Listing / CSA Certifications and BURNDY will not be liable for the connection.

Compression Connections

Copper Compression — Terminal — Code — Two Hole
Narrow Tongue, Standard Barrel — with Inspection Window

TYPE YA-L-2NT

HYLUG™

Uninsulated Copper Compression Terminal
UL Listed 90° C, Up to 35 kV ♦

45° and 90° angles available. Please contact Customer Service to order:
1-800-346-4175

Features & Benefits

- Inspection window allows for visual verification that the wire has been fully inserted prior to crimping the lug
- Narrow tongue/tang is designed for limited space applications
- Barrel is designed with an internal chamfer at the wire entry to ensure smooth insertion of the wire, preventing possible damaging of the strands
- Short/Standard length barrel is recommended for installations with limited space requirements
- Two hole tongue/tang is recommended when space permits as the 2-hole feature minimizes the terminations from loosening or rotating under vibration, movement, or heat cycling
- 45° and 90° angular lugs are available; please contact Customer Service
- Electro-tin plated unless otherwise specified to reduce galvanic corrosion (bimetallic) and resist corrosive elements
- Connectors are clearly marked with stamping and barrel color coding
- BURNDY certifies its products using the BURNDY Engineered System and select other crimp tool manufacturers in accordance with one or more of the UL categories in order to obtain a UL Listing
- Terminals and splices accommodating code wire: Accommodates Code Class B (Concentric, Compressed, Compact) and Class C wire

Accessories

- Hardware - Section F
- PENETROX™ Oxide Inhibitor - Section F
- Heat and Cold Shrink Tubing - Section D
- WIREMIKE™ Wire Micrometer - Section F
- Wire Management (Cable Ties) - Section G

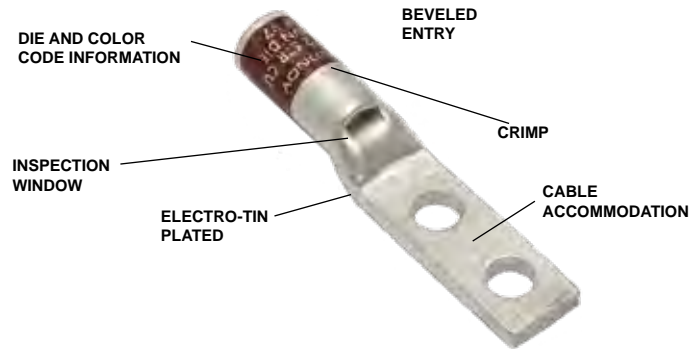

NOTE: Field bending straight lugs to achieve an angular connection will void UL Listing / CSA Certifications and BURNDY will not be liable for the connection.

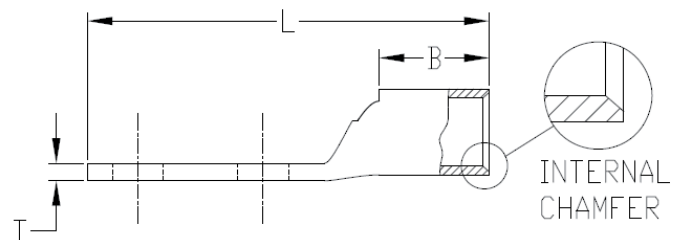
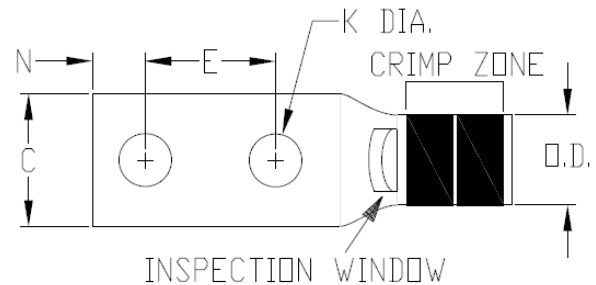

TYPE YA-L-2NT (Continued)

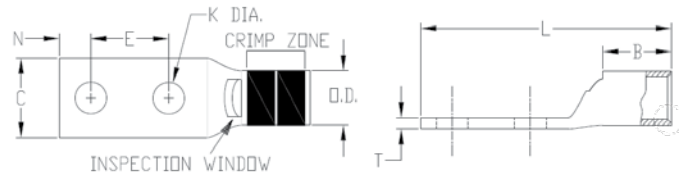

▲ See Copper Code Standard Barrel Terminal Tooling Tables in this section for complete tool and die listing information.

Catalog Number	Conductor			Color Code	Die Index	Stud Size	Figure Dimensions								Wire Strip Length
	Code	Flex	Metric MM ² ***				Stud Hole Diameter (K)	Outside Diameter (OD)	Barrel Length (B)	Pad Width (C)	Overall Length (L)	Hole Spacing (E & F)	Hole Offset (N)	Pad Thickness (T)	
YA2CL2NT14	#2 AWG	-	35	Brown	10	1/4	0.27	0.42	0.88	0.48	2.47	5/8	0.31	0.11	15/16
YA2CL2NT14E2						1/4	0.27	0.42	0.88	0.48	2.60	1/4	0.31	0.11	
YA2CL2NT14E1						1/4	0.27	0.42	0.88	0.48	2.84	1	0.31	0.11	
YA1CL2NT14	#1 AWG	-	50	Green	11	1/4	0.27	0.46	0.88	0.50	2.55	5/8	0.31	0.11	15/16
YA1CL2NT14E2						1/4	0.27	0.46	0.88	0.50	2.68	3/4	0.31	0.10	
YA25L2NT14	1/0 AWG	-	-	Pink	12	1/4	0.27	0.51	0.88	0.48	2.56	5/8	0.31	0.12	15/16
YA25L2NT14E1						1/4	0.27	0.51	0.88	0.48	3.28	1	0.25	0.12	
YA26L2NT14	2/0 AWG	-	70	Black	13	1/4	0.27	0.56	0.94	0.48	2.66	5/8	0.25	0.12	1
YA26L2NT14E1						1/4	0.27	0.56	0.94	0.48	3.03	1	0.25	0.12	
YA27L2NT14	3/0 AWG	-	-	Orange	14	1/4	0.27	0.62	1.00	0.76	2.73	5/8	0.31	0.13	1-1/16
YA27L2NT38						3/8	0.41	0.62	1.00	0.60	3.30	1	0.41	0.13	
YA27L2NT516						5/16	0.33	0.62	1.00	0.60	3.26	1	0.31	0.13	
YA28L2NT14	4/0 AWG	-	-	Purple	15	1/4	0.27	0.69	0.88	0.76	2.65	5/8	0.31	0.13	1-1/16
YA29L2NT38	250 kcmil	-	-	Yellow	16	3/8	0.41	0.75	1.00	0.80	3.43	1	0.41	0.16	1-1/8
YA29L2NT38E16						3/8	0.41	0.75	1.06	0.80	4.18	1-3/4	0.41	0.16	
YA31L2NT38	350 kcmil	-	185	Red	18	3/8	0.41	0.88	1.06	0.96	3.51	1	0.41	0.18	1-1/8
YA31L2NT38E16						3/8	0.41	0.88	1.06	0.88	4.26	1-3/4	0.41	0.18	
YA34L2NT38	500 kcmil	-	240	Brown	20 or 22	3/8	0.41	1.06	1.27	0.96	3.65	1	0.41	0.23	1-7/16
YA34L2NT38E16						3/8	0.41	1.06	1.27	0.96	4.63	1-3/4	0.41	0.23	
YA34L2NT12E1						1/2	0.53	1.06	1.27	0.96	4.13	1	0.53	0.23	
YA36L2NNT	600 kcmil	-	300	Green	472	1/2	0.53	1.19	1.38	1.12	5.43	1-3/4	0.63	0.27	1-3/4
YA39L2NT38	750 kcmil	-	-	Black	24	3/8	0.41	1.30	1.42	1.63	4.34	1	0.50	0.27	1-1/2
YA39L2NT38E16						3/8	0.41	1.30	1.42	1.30	5.11	1-3/4	0.50	0.27	
YA39L2NT12E1						1/2	0.53	1.30	1.42	1.30	4.42	1	0.53	0.27	
YA44L2NTC12E24	1000 kcmil	-	500	White	27	1/2	0.53	1.50	1.65	1.63	5.65	1.85	0.53	0.33	1-15/16

*** The MM² conductor sizes listed are the recommendations for Class 2 conductor

◆ For applications greater than 2000 volts consult cable manufacturer for voltage stress relief instructions

Notes: All dimensions shown are for reference only.

Field bending straight lugs to achieve an angular connection will void UL Listing / CSA Certifications and BURNDY will not be liable for the connection.

Compression Connections

Copper Compression — Terminal — Code / Flex — Slotted Standard Barrel — with Inspection Window

TYPES YA-L2TC-SL, YAV-L2TC-FXSL

HYLUG™

Uninsulated Copper Compression Terminal
UL Listed 90° C, Up to 35 kV ♦



Compression slotted lugs connect copper or tinned copper conductors to bus bars, CPI racks, cabinets or cable runway. Slotted and 90° slotted lugs have one round and one oblong hole to match hole spacing on equipment mounting rails on CPI racks and cabinets and on some bus bars.

NOTE: Field bending straight lugs to achieve an angular connection will void UL Listing / CSA Certifications and BURNDY will not be liable for the connection.

Features & Benefits

- Inspection window allows for visual verification that the wire has been fully inserted prior to crimping the lug
- Barrel is designed with an internal chamfer at the wire entry to ensure smooth insertion of the wire, preventing possible damaging of the wire strands during installation
- Short/standard length barrel is recommended for installations with limited space requirements
- One hole with slotted second hole tongue/tang offers additional flexibility over a standard 2-hole tongue/tang as the slot provides the installer with multiple mounting hole alignments options. The 2-hole feature minimizes the terminations from loosening or rotating under vibration, movement or heat cycling
- 45° and 90° angular lugs are available; please contact Customer Service
- Electro-tin plated unless specified to reduce galvanic corrosion (bimetallic) and resist corrosive elements
- Connectors are clearly marked with stamping and barrel color coding
- BURNDY certifies its products using the BURNDY Engineered System and select other crimp tool manufacturers in accordance with one or more of the UL categories in order to obtain a UL Listing
- Terminals and splices accommodating code wire: Accommodates Code Class B (Concentric, Compressed, Compact) and Class C wire

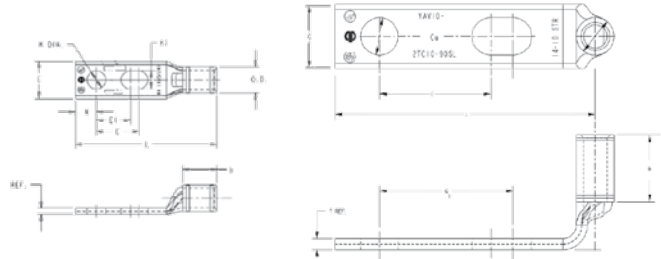

Catalog Number	Cond. Size	Stud Hole Size	Tongue Width	Figure Dimensions					Installation Tooling (# of crimps)					Wire Strip Length	
				(B)	(T)	(L)	(E)	(E1)	Dieless	MD6, OUR840, MD734R	500 Series	35, 750, 46** Series	Color Code		Die Index
YA6CL2TC14E2SL	#6 AWG G,H,I,K,M DLO (61/24)	1/4	0.45	0.81	0.08	2.47	0.62	0.75	MY29 Series (1)	W5CRT (1) W5CVT (1) X5CRT (1) X8CART (1)	W5CRT (1) W5CVT (1)	U5CRT (1) U8CABT (1)	Blue	7 or 374	7/8
YAV6CL2TC10FX90SL*	#6 AWG	#10	0.48	0.50	0.08	1.54	0.62	0.75	MY29 Series (1)	W5CRT (1) W5CVT (1) X5CRT (1) X8CART (1)	W5CRT (1) W5CVT (1)	U5CRT (1) U8CABT (1)	Blue	7 or 374	7/8
YAV4CL2TC14FXSL	#4 AWG G,H,I,K,M DLO (105/24)	1/4	0.55	0.50	0.09	2.08	0.50	0.62	MY29 Series (1) 644 Series (1) 444 Series (1) 81K Series (1)	W4CRT (1) W4CVT (1) X4CRT (1)	W4CRT (1) W4CVT (1) X4CRT (1)	U4CRT (1)	Gray	8	9/16
YAV4CL2TC38FXSL	#4 AWG	3/8	0.58	0.50	0.08	2.68	0.75	1.00		W2CRT (1) W2CVT (1) X2CRT (1)	W2CRT (1) W2CVT (1) X2CRT (1)	U2CRT (1)	Brown	10	11/16
YAV2CL2TC14FXSL	#2 AWG G,H,I,K,M DLO (150/24)	1/4	0.68	0.62	0.10	2.26	0.50	0.62		W2CRT (1) W2CVT (1) X2CRT (1)	W2CRT (1) W2CVT (1) X2CRT (1)	U2CRT (1)	Brown	10	11/16
YAV2CL2TC38FXSL	#2 AWG	3/8	0.68	0.62	0.10	2.82	0.75	1.0	644 Series (1) 444 Series (1) 81K Series (2)	—	—	U44XRT (2)	Yellow	L115	1-2/3

* Denotes 90° Angle

Note: All dimensions shown are for reference only.

**Use PUADP1 adapter with U dies in 46 Series of tools

TYPES YA-L-4TC, YAV-L-4TC-FX

HYLUG™

Uninsulated Copper Compression Terminal
UL Listed 90° C, Up to 35 kV ◆



Features & Benefits

- Inspection window allows for visual verification that the wire has been fully inserted prior to crimping the lug
- Split feature in the tongue/tang is used when connecting two separate terminal blocks for the same phase; the slot provides the needed equipment gap while allowing the proper mounting hole alignment
- Barrel is designed with an internal chamfer at the wire entry to ensure smooth insertion of the wire, preventing possible damaging of the wire strands during installation
- Short/standard length barrel is recommended for installations with limited space requirements
- Two hole tongue/tang is recommended when space permits as the 2-hole feature minimizes the terminations from loosening or rotating under vibration, movement or heat cycling
- 45° and 90° angular lugs are available; please contact Customer Service
- Electro-tin plated unless specified to reduce galvanic corrosion (bimetallic) and resist corrosive elements
- Connectors are clearly marked with stamping and barrel color coding
- BURNDY certifies its products using the BURNDY Engineered System and select other crimp tool manufacturers in accordance with one or more of the UL categories in order to obtain a UL Listing
- Terminals and splices accommodating code wire: Accommodates Code Class B (Concentric, Compressed, Compact) and Class C wire

NOTE: Field bending straight lugs to achieve an angular connection will void UL Listing / CSA Certifications and BURNDY will not be liable for the connection.

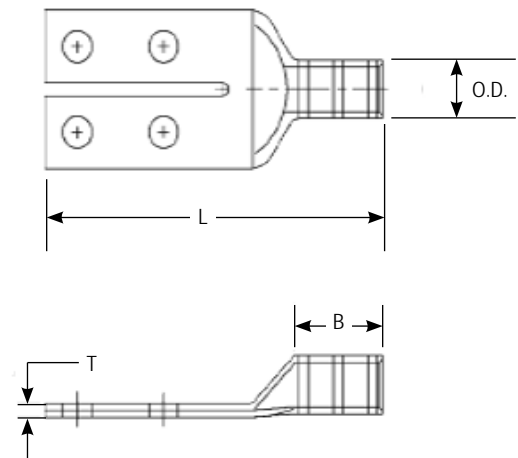

Catalog Number	Wire Size	Stud Hole Size	Stud Hole Spacing	Tongue Width	Figure Dimensions			Installation Tooling					Wire Strip Length	
					(B)	(T)	(L)	Dieless (# of crimps)	MD6, OUR840, MD734R	500 Series	35, 750, 46** Series	Color Code		Die Index
YA25L4TCG1	1/0 AWG	1/4	0.62	1.38	0.88	0.11	3.05	MY29 Series (1) 644 Series (1) 444 Series (1)	X25RT (2) W25RT (2) W25VT (2)	X25RT (2) W25RT (2) W25VT (2)	U25RT (1) U2CABT (1)	Pink	12 or 348	15/16
YA26L4TCG1	2/0 AWG	1/4	0.62	1.38	0.94	0.21	3.15		X26RT (2) W26RT (2) W26VT (2)	X26RT (2) W26RT (2) W26VT (2)	U26RT (1) U26D1 (1)	Black	13	1
YA27L4TCG1	3/0 AWG	1/4	0.62	1.38	1.00	0.21	3.25		X27RT (3) W27RT (2) W27VT (2)	X27RT (3) W27RT (2) W27VT (2)	U27RT (1) U27D1 (1)	Orange	14	1-1/16
YA28L4TCG1	4/0 AWG	1/4	0.62	1.38	1.00	0.21	3.29		X28RT (3) W28RT (2) W28VT (2)	X28RT (3) W28RT (2) W28VT (2)	U28RT (1) U28D1 (1)	Purple	15	1-1/8
YAV28L4TCG1		1/4	0.62	1.38	1.00	0.21	3.29		W28VT (2)	W28VT (2)	U28RT (1)	Purple	15	11/16
YA29L4TCG1	250 kcmil	1/4	0.62	1.38	1.06	0.21	3.39		X29RT (4) W29RT (2) W29VT (2)	X29RT (4) W29RT (2) W29VT (2)	U29RT (1) U29D1 (1)	Yellow	16	1-1/8
YA31L4TCG1	350 kcmil	1/4	0.62	1.38	1.06	0.21	3.46		W31RT (2) W31VT (2)	W31RT (2) W31VT (2)	U31RT (2) U29ART (2)	Red	18 or 324	1-1/8

TYPE YA-E

E-LINE HYLUG™ Equipment Line



UL Listed 90° C, Up to 35 kV ◆

Type YA-E Equipment terminals are designed to provide replacements for original equipment mechanical or other compression terminals. These narrow tongue terminals are specially designed to fit in tight areas. Whether you're upgrading or replacing, YA-E connectors will provide for any of your cable termination needs. When installed with our dieless tool, these terminals can accommodate a range of conductor sizes.



NOTE: Field bending straight lugs to achieve an angular connection will void UL Listing / CSA Certifications and BURNDY will not be liable for the connection.

Features & Benefits

- Narrow tongue/tang is designed to allow for more parallel terminations of wire in limited space applications
- Terminals are available in copper material
- Barrel is designed with an internal chamfer at the wire entry to ensure smooth insertion of the wire
- One or two-hole tongue/tang styles are available; 2-hole tongue/tang is recommended when space permits as the 2-hole feature minimizes the terminations from loosening or rotating under vibration, movement or heat cycling
- Electro-tin plated unless specified to reduce galvanic corrosion (bimetallic) and resist corrosive elements
- Connectors are clearly marked with stamping and barrel color coding
- Overlap crimps should crimp the entire crimp zone
- BURNDY certifies its products using the BURNDY Engineered System and select other crimp tool manufacturers in accordance with one or more of the UL categories in order to obtain a UL Listing
- Terminals and splices accommodating code wire: Accommodates Code Class B (Concentric, Compressed, Compact) and Class C wire

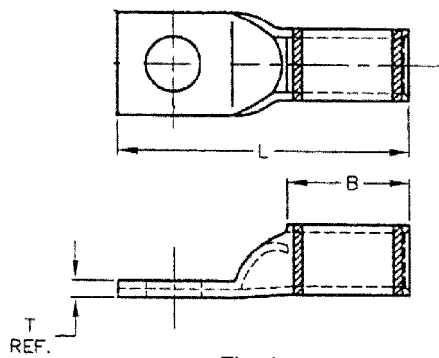

Fig. 1

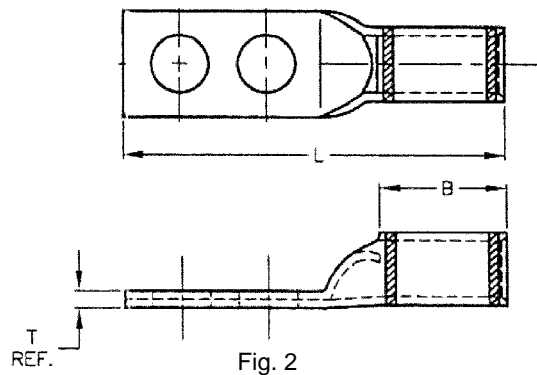

Fig. 2

TYPE YA-E (Continued)



NOTE: Field bending straight lugs to achieve an angular connection will void UL Listing / CSA Certifications and BURNDY will not be liable for the connection.



COPPER E-LINE HYLUG™ COMPRESSION TERMINALS

Catalog Number	Fig. No.	Conductor Accommodations		Stud Hole Size	Stud Hole Spacing	Tongue Width (max)	Dimensions			† Installation Tooling					Wire Strip Length
		Copper Only					B	T	L	Dieless (# of crimps)	MD6, MD7 (# of crimps)	35, 750, 46* Series (# of crimps)	Color Code	Die Index	
		AWG/KCMIL	Expanded Wire Range using 644 / 444 Series												
YA25LN50T14E	1	1/0 AWG	#6 - 1/0 AWG	1/4	—	0.50	0.88	0.12	1.84	644 Series (1) 444 Series (1)	W25RT (2)	U25RT (1)	Pink	12 or 348	15/16
YA25LN64T516E				5/16	—	0.64	0.88	0.12	1.96		W25VT (2)	U2CABT (1)			
YA26LN50T14E	1	2/0 AWG	#4 - 2/0 AWG	1/4	—	0.50	0.94	0.12	1.94	81K Series (1)	W26RT (2) W26VT (2)	U26RT (1)	Black	13	1
YA30L24N100T38E	1	300 kcmil	2/0 AWG - 300 kcmil	3/8	—	1.00	1.03	0.16	2.44	644 Series (1) 444 Series (1) 81K Series (2)	W30RT (2)	U30RT (2) U28ART (2)	White	17 or 298	1-1/16
YA34L6N131T12E	1	500 kcmil	4/0 AWG - 500 kcmil	1/2	—	1.31	1.27	0.23	3.31		—	U34RT (2)	Brown	20 or 299	1-5/16
YA342LNN119T12E	2			1/2	1.75	1.19	1.27	0.22	5.06		—	U31ART (2)			
YA342LNN131T12E	2			1/2	1.75	1.31	1.27	0.22	5.06		—	P34RT (2)			
YA39L6N131T12E	1	750 kcmil	500 - 750 kcmil	1/2	—	1.31	1.42	0.27	3.61		—	U39RT (2)	Black	24	1-1/2
YA392LNN131T12E	2			1/2	1.75	1.31	1.42	0.27	5.37						

▲ See Copper Code Standard Barrel Terminal Tooling Tables in this section for complete tool and die listing information.

Note: All dimensions shown are for reference only

Compression Connections

Copper Code Standard Barrel Terminal Tooling Table
Mechanical/Ratchet (Dedicated Die or Requiring Dies)

Catalog Number Type	Wire Size	Color Code and Die Index Number	Mechanical & Ratchet Dies Required (# Crimps)		Mechanical & Ratchet Dedicated Die Tools # Crimps				
	Conductor (CU Only)		MD6 and MD7 Series <small>*Due to handle force not recommended</small>	OUR840 <small>*Due to handle force not recommended</small>	MY28 and MY29 Series	MRC840	MRE1022B Y8MRB1 Y10D Y1022	Y122CMR	Y1MRTC
YA-10	#14 - #10 Str #12 - #10 Sol B,C	—	—	—	—	—	1 CRIMP	1 CRIMP	—
YA-8C-L	#8 AWG B,C,G,H,I,K,M DLO #6 Sol / #8 Sol	RED 49	X8CRT (1) W8CRT (1) W8CVT (1)	X8CRT (1) W8CRT (1) W8CVT (1)	1 CRIMP	1 CRIMP	—	1 CRIMP	1 CRIMP
YA-6C-L	#6 AWG Str / Sol B,C	BLUE 7	X5CRT (1) W5CRT (1) W5CVT (1)	X5CRT (1) W5CRT (1) W5CVT (1)	1 CRIMP	1 CRIMP	—	1 CRIMP	1 CRIMP
YA-5C-L	#5 AWG B,C	BLUE 7	X5CRT (1) W5CRT (1) W5CVT (1)	X5CRT (1) W5CRT (1) W5CVT (1)	1 CRIMP	1 CRIMP	—	1 CRIMP	1 CRIMP
YA-4C-L	#4 AWG B,C	GRAY 8	X4CRT (1) W4CRT (1) W4CVT (1)	X4CRT (1) W4CRT (1) W4CVT (1)	1 CRIMP	1 CRIMP	—	2 CRIMPS	2 CRIMPS
YA-3C-L	#3 Str / #2 Sol B,C	WHITE 9	W3CRT (1)	W3CRT (1)	1 CRIMP	1 CRIMP	—	2 CRIMPS	2 CRIMPS
YA-2C-L	#2 AWG B,C	BROWN 10	X2CRT (1) W2CRT (1) W2CVT (1)	X2CRT (1) W2CRT (1) W2CVT (1)	1 CRIMP	1 CRIMP	—	2 CRIMPS	2 CRIMPS
YA-1C-L	#1 AWG B,C	GREEN 11	X1CRT1 (1) W1CRT1 (1) W1CVT (1)	X1CRT1 (1) W1CRT1 (1) W1CVT (1)	1 CRIMP	1 CRIMP	—	—	2 CRIMPS
YA-25-L	1/0 AWG B,C	PINK 12	X25RT (2) W25RT (2) W25VT (2)	X25RT (2) W25RT (2)* W25VT (2)*	1 CRIMP	2 CRIMPS	—	—	—
YA-26-L	2/0 AWG B,C	BLACK 13	X26RT (2) W26RT (2) W26VT (2)	X26RT (2) W26RT (2)* W26VT (2)*	1 CRIMP	2 CRIMPS	—	—	—
YA-27-L	3/0 AWG B,C	ORANGE 14	X27RT (3) W27RT (2) W27VT (2)	X27RT (3) W27RT (2)* W27VT (2)*	1 CRIMP	2 CRIMPS	—	—	—
YA-28-L	4/0 AWG B,C	PURPLE 15	X28RT (3) W28RT (2) W28VT (2)	X28RT (3) W28RT (2)* W28VT (2)*	1 CRIMP	2 CRIMPS	—	—	—
YA-29-L	250 kcmil B,C	YELLOW 16	X29RT (4) W29RT (2) W29VT (2)	X29RT (4) W29RT (2)* W29VT (2)*	1 CRIMP	—	—	—	—
YA-30-L	300 kcmil B,C	WHITE 17	W30RT (2)* W30VT (2)	—	—	—	—	—	—
YA-31-L	350 kcmil B,C	RED 18	W31RT (2)* W31VT (2)	—	—	—	—	—	—
YA-32-L	400 kcmil B,C	BLUE 19	W32RT (2)* W32VT (2)	—	—	—	—	—	—
YA-33-L	450 kcmil B,C	GRAY 326	W33RT (2)* W33VT (2)	—	—	—	—	—	—
YA-34-L	500 kcmil B,C	BROWN 20	W34RT (2)* W34VT (2)	—	—	—	—	—	—

Catalog Number Type	Wire Size	Color Code and Die Index Number	Hydraulic Tools - Dies Required (# Crimps)					Hydraulic Tools - Dieless	
	Conductor (CU Only)		MD6, 600, 500 Series	750, 35 Series	45 Series <i>Use PT6515 with U Dies</i>	46 Series <i>Use PUADP1 with U Dies</i>	60 Series	81K 4PC Series	644 444 Series
YA-10	#14 - #10 Str #12 - #10 Sol B,C	—	—	—	—	—	—	—	—
YA-8C-L	#8 AWG B,C,G,H,I,K,M DLO #6 Sol / #8 Sol	RED 49	X8CRT (1) W8CRT (1) W8CVT (1)	U8CRT (1)	U8CRT (1)	U8CRT (1)	—	1 CRIMP	—
YA-6C-L	#6 AWG Str / Sol B,C	BLUE 7	X5CRT (1) W5CRT (1) W5CVT (1)	U5CRT (1)	U5CRT (1)	U5CRT (1)	—	1 CRIMP	—
YA-5C-L	#5 AWG B,C	BLUE 7	X5CRT (1) W5CRT (1) W5CVT (1)	U5CRT (1)	U5CRT (1)	U5CRT (1)	—	1 CRIMP	—
YA-4C-L	#4 AWG B,C	GRAY 8	X4CRT (1) W4CRT (1) W4CVT (1)	U4CRT (1)	U4CRT (1)	U4CRT (1)	—	1 CRIMP	1 CRIMP
YA-3C-L	#3 Str / #2 Sol B,C	WHITE 9	W3CRT (1)	U3CRT (1)	U3CRT (1)	U3CRT (1)	—	1 CRIMP	1 CRIMP
YA-2C-L	#2 AWG B,C	BROWN 10	X2CRT (1) W2CRT (1) W2CVT (1)	U2CRT (1)	U2CRT (1)	U2CRT (1)	—	1 CRIMP	1 CRIMP
YA-1C-L	#1 AWG B,C	GREEN 11	X1CRT1 (1) W1CRT1 (1) W1CVT (1)	U1CRT1 (1)	U1CRT1 (1)	U1CRT1 (1)	—	1 CRIMP	1 CRIMP
YA-25-L	1/0 AWG B,C	PINK 12	X25RT (2) W25RT (2) W25VT (2)	U25RT (1)	U25RT (1)	U25RT (1)	—	1 CRIMP	1 CRIMP
YA-26-L	2/0 AWG B,C	BLACK 13	X26RT (2) W26RT (2) W26VT (2)	U26RT (1)	U26RT (1)	U26RT (1)	—	1 CRIMP	1 CRIMP
YA-27-L	3/0 AWG B,C	ORANGE 14	X27RT (3) W27RT (2) W27VT (2)	U27RT (1)	U27RT (1)	U27RT (1)	—	2 OVERLAPPING CRIMPS	1 CRIMP
YA-28-L	4/0 AWG B,C	PURPLE 15	X28RT (3) W28RT (2) W28VT (2)	U28RT (1)	U28RT (1)	U28RT (1)	L28RT (1)	2 OVERLAPPING CRIMPS	1 CRIMP
YA-29-L	250 kcmil B,C	YELLOW 16	X29RT (4) W29RT (2) W29VT (2)	U29RT (1)	U29RT (1)	U29RT (1)	L29RT (1)	2 OVERLAPPING CRIMPS	1 CRIMP
YA-30-L	300 kcmil B,C	WHITE 17	W30RT (2) W30VT (2)	U30RT (2)	U30RT (2)	U30RT (2)	L30RT (1)	2 OVERLAPPING CRIMPS	1 CRIMP
YA-31-L	350 kcmil B,C	RED 18	W31RT (2) W31VT (2)	U31RT (2)	U31RT (2)	U31RT (2)	L31RT (1)	2 OVERLAPPING CRIMPS	1 CRIMP
YA-32-L	400 kcmil B,C	BLUE 19	W32RT (2) W32VT (2)	U32RT (2)	U32RT (2)	U32RT (2)	L32RT (1)	2 OVERLAPPING CRIMPS	1 CRIMP

Compression Connections

Copper Code Standard Barrel Terminal Tooling Table
Hydraulic Requiring Dies and Dieless

Catalog Number Type	Wire Size	Color Code and Die Index Number	Hydraulic Tools - Dies Required (# Crimps)					Hydraulic Tools - Dieless	
	Conductor (CU Only)		MD6, 600, 500 Series	750, 35 Series	45 Series <i>Use PT6515 with U Dies</i>	46 Series <i>Use PUADP1 with U Dies</i>	60 Series	81K 4PC Series	644 444 Series
YA-33-L	450 kcmil B,C	GRAY 326	W33RT (2) W33VT (2)	U33RT (2)	U33RT (2)	U33RT (2)	L33RT (1)	2 OVERLAPPING CRIMPS	1 CRIMP
YA-34-L	500 kcmil B,C	BROWN 20	W34RT (2) W34VT (2)	U34RT (2)	U34RT (2)	U34RT (2)	L34RT (1)	2 OVERLAPPING CRIMPS	1 CRIMP
YA-35-L	550 kcmil B,C	YELLOW 21	—	U35RT (2)	U35RT (2)	U35RT (2)	L35RT (1)	2 OVERLAPPING CRIMPS	1 CRIMP
YA-36-L	600 kcmil B,C	GREEN 22	—	U36RT (2)	U36RT (2)	U36RT (2)	L36RT (1)	2 OVERLAPPING CRIMPS	1 CRIMP
YA-37-L	650 kcmil B,C	ORANGE 23	—	U37RT (2)	U37RT (2)	U37RT (2)	L37RT (1)	3 OVERLAPPING CRIMPS	1 CRIMP
YA-38-L	700 kcmil B,C	PINK 400	—	U38RT (2)	U38RT (2)	U38RT (2)	L38RT (1)	3 OVERLAPPING CRIMPS	1 CRIMP
YA-39-L	750 kcmil B,C	BLACK 24	—	U39RT (2)	U39RT (2)	U39RT (2) P39RT (2)	L39RT (1)	3 OVERLAPPING CRIMPS	1 CRIMP
YA-40-L	800 kcmil B,C	ORANGE 25	—	—	S40RT (3)	P40RT (3)	L40RT (1)	3 OVERLAPPING CRIMPS	1 CRIMP
YA-41-L	850 kcmil B,C	GOLD 26	—	—	—	P41D with P44PR (1)	—	3 OVERLAPPING CRIMPS	1 CRIMP
YA-44-L	1000 kcmil B,C	WHITE 27	—	—	S44RT (3)	P44RT (3)	L44RT (2)	3 OVERLAPPING CRIMPS	1 CRIMP
YA-45-L	1250 kcmil B,C	YELLOW 29	—	—	S45RT (3)	P45RT (3)	L45RT (2)	—	—
YA-453-L	1300 kcmil B,C	ORANGE 30	—	—	—	—	—	—	—
YA-46-L	1500 kcmil B,C	GREEN 31	—	—	S46RT (3)	P46RT (3)	L46RT (2)	—	—
YA-47-L	1750 kcmil B,C	GRAY 33	—	—	—	—	L47RT (2)	—	—
YA-48-L	2000 kcmil B,C	BROWN 34	—	—	—	—	L48RT (3)	—	—

Installation Instructions

Installation instructions help the installer understand proper wire preparation, proper insertion requirements, crimp zone location, individual crimp location, crimp order and crimp direction, to ensure safe and reliable wire connections. UL Listing and CSA Certification are only valid when using the BURNDY® Engineered System and following BURNDY Installation Instructions.

Copper Code Standard Barrel Terminal Installation Steps:

1. Select the appropriate connector based on:
Wire Material
Wire Construction
Wire Size
2. Strip the insulation to the appropriate wire strip length, based on the table's Wire Strip Length recommendation for the selected connector. Due to tolerances in the connector, wire strip length, and insulation stripping tools, this range may be 0" - 1/4". The exposed wire, also known as a "shiner", has no performance impact on the connection and there is no wire exposure requirement by BURNDY.
3. As a best practice, wire brush the bare conductor to remove any oxides. DO NOT wire brush tin-plated connectors.
4. Insert the conductor into the barrel for the full length. If the connector has an inspection window, the conductor end can easily be seen to verify full wire insertion.
5. Apply the proper number of crimps specified by the appropriate illustration.
6. *Some catalog numbers require overlapping crimps when using the 81K or 4PC Series of installation tools. Please refer to the overlapping crimp image that is applicable based on the number of crimps required. Overlap each consecutive crimp so that the completed installation of all overlapping crimps covers the entire crimp zone.
7. Once all crimps have been completed, the connection can be easily inspected for proper installation.

NOTE: Illustrations show black bands however this is just a representation of the crimp zones. See individual connector for actual crimp band color.

Example: YA28LBOX

- Go to the YA-28-L Catalog Number Designation for 4/0 AWG.
- Confirm the Tool (750 Series for this example).
- Confirm the Die Set Needed (U28RT for this example)
- Confirm the Number of Crimps Necessary (1 for this example)
- For proper crimp placement refer to the image on this page corresponding to the number of crimps.



CATALOG NUMBER DESIGNATIONS					
YA-8C-L	YA-6C-L	YA-5C-L	YA-4C-L	YA-3C-L	YA-2C-L
YA-1C-L	YA-37-L*	YA-38-L*	YA-40-L*	YA-41-L*	YA-44-L*

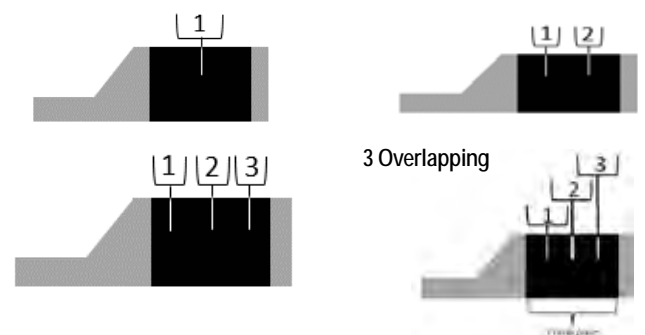

CATALOG NUMBER DESIGNATIONS					
YA-25-L	YA-26-L	YA-27-L*	YA-28-L*	YA-29-L*	YA-30-L*
YA-31-L*	YA-32-L*	YA-33-L*	YA-34-L*	YA-35-L*	YA-36-L*
YA-39-L*	YA-45-L	YA-453-L	YA-46-L	YA-47-L	YA-48-L

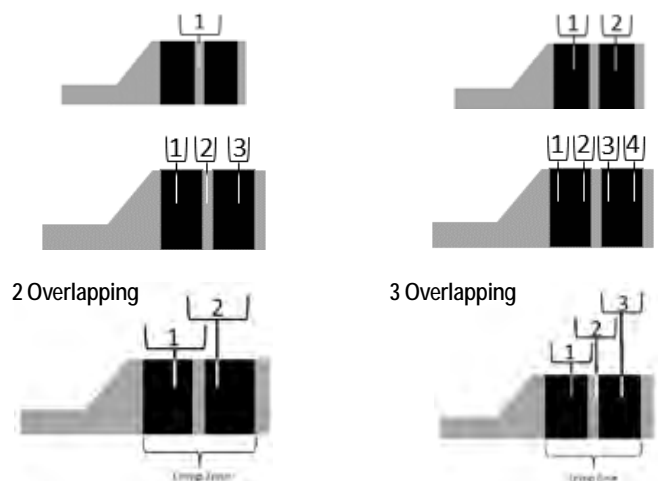

Compression Connections

Copper Compression — Terminal — Code — One Hole
Long Barrel — with Inspection Window

TYPE YAZ

HYLUG™

Uninsulated Copper Compression Terminal
UL Listed 90° C, Up to 35 kV ♦

45° and 90° angles available. Please contact Customer Service to order:
1-800-346-4175

Features & Benefits

- Inspection window allows for visual verification that the wire has been fully inserted prior to crimping the lug
- Barrel is designed with an internal chamfer at the wire entry to ensure smooth insertion of the wire, preventing possible damaging of the strands
- Long barrel allows for an increased number of crimps which will increase the mechanical strength of the connection
- 45° and 90° angular lugs are available; please contact Customer Service
- Electro-tin plated unless otherwise specified to reduce galvanic corrosion (bimetallic) and resist corrosive elements
- Connectors are clearly marked with stamping and barrel color coding
- BURNDY certifies its products using the BURNDY Engineered System and select other crimp tool manufacturers in accordance with one or more of the UL categories in order to obtain a UL Listing
- Terminals and splices accommodating code wire: Accommodates Code Class B (Concentric, Compressed, Compact) and Class C wire

Accessories

- Hardware - Section F
- PENETROX™ Oxide Inhibitor - Section F
- Heat and Cold Shrink Tubing - Section D
- WIREMIKE™ Wire Micrometer - Section F
- Wire Management (Cable Ties) - Section G

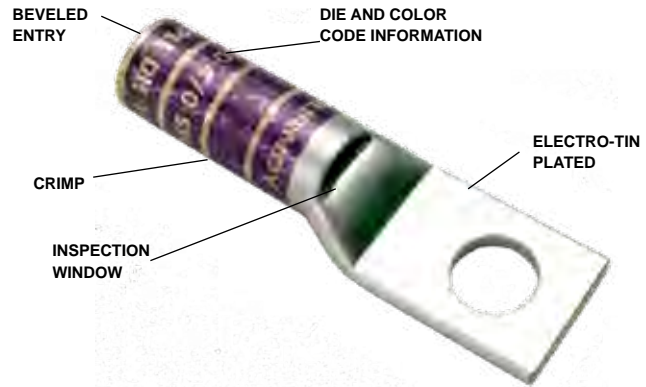

NOTE: Field bending straight lugs to achieve an angular connection will void UL Listing / CSA Certifications and BURNDY will not be liable for the connection.

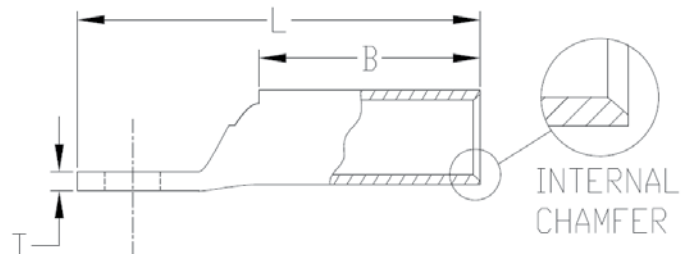
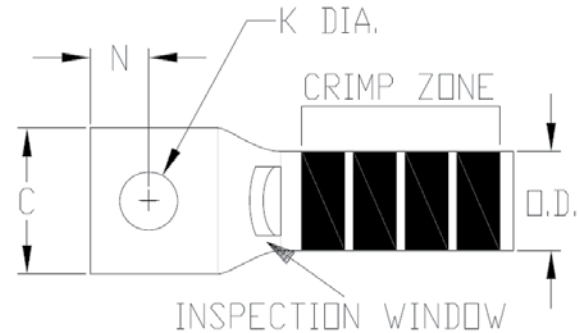

TYPE YAZ (Continued)

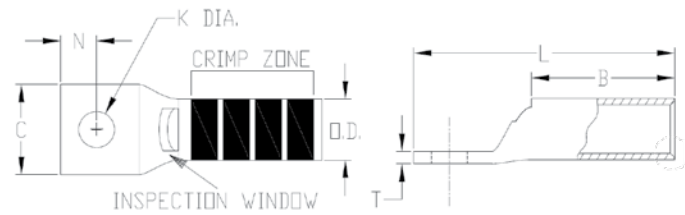

▲ See Copper Code Long Barrel Terminal Tooling Tables in this section for complete tool and die listing information.

Catalog Number	Conductor			Color Code	Die Index	Stud Size	Figure Dimensions								Wire Strip Length
	Code	Flex	Metric MM ² ***				Stud Hole Diameter (K)	Outside Diameter (OD)	Barrel Length (B)	Pad Width (C)	Overall Length (L)	Hole Spacing (E) & (F)	Hole Offset (N)	Pad Thickness (T)	
YAZV10TC14	14-10 AWG 12- 10 Sol	—	6	—	—	1/4	0.27	0.21	0.69	0.41	1.52	—	0.31	0.05	3/4
YAZ8CTC10	8 AWG	#8 G,H,I,K,M DLO	10	Red	49	#10	0.21	0.27	0.75	0.41	1.43	—	0.25	0.08	13/16
YAZ8CTC14						1/4	0.27	0.27	0.75	0.44	1.56	—	0.31	0.08	
YAZ8CTC38						3/8	0.40	0.27	0.75	0.58	1.75	—	0.41	0.06	
YAZ6CTC10	6 AWG 6 Sol	—	—	Blue	7 or 374	#10	0.21	0.29	1.12	0.42	1.89	—	0.25	0.09	1-3/16
YAZ6CTC14						1/4	0.27	0.29	1.12	0.45	2.02	—	0.31	0.08	
YAZ6CTC38						3/8	0.40	0.29	1.12	0.58	2.21	—	0.41	0.06	
YAZ6CTC12						1/2	0.52	0.29	1.12	0.75	2.46	—	0.53	0.12	
YAZ5CTC12	5 AWG	—	—	Blue	7 or 374	1/2	0.52	0.30	1.12	0.83	2.48	—	0.53	0.12	1-3/16
YAZ4CTC14	4 AWG	—	—	Gray	8 or 346	1/4	0.27	0.34	1.12	0.50	2.04	—	—	0.09	1-3/16
YAZ4CTC38						3/8	0.41	0.34	1.12	0.58	2.22	—	—	0.08	
YAZ4CTC12						1/2	0.52	0.34	1.12	0.73	2.50	—	—	0.06	
YAZ3CTC14	3 AWG 2 Sol	—	25	White	9	1/4	0.27	0.38	1.25	0.55	2.19	—	0.31	0.09	1-5/16
YAZ3CTC38						3/8	0.40	0.38	1.25	0.58	2.38	—	0.41	0.08	
YAZ3CTC12						1/2	0.52	0.38	1.25	0.71	2.63	—	0.53	0.07	
YAZ2CTC14	2 AWG	—	35	Brown	10	1/4	0.27	0.42	1.25	0.60	2.21	—	0.31	0.11	1-5/16
YAZ2CTC516						5/16	0.33	0.42	1.25	0.60	2.27	—	0.34	0.11	
YAZ2CTC38						3/8	0.40	0.42	1.25	0.60	2.40	—	0.41	0.11	
YAZ2CTC12						1/2	0.52	0.42	1.25	0.73	2.65	—	0.53	0.09	
YAZ1CTC14	1 AWG	—	50	Green	11 or 375	1/4	0.27	0.46	1.38	0.68	2.37	—	0.31	0.10	1-7/16
YAZ1CTC38						3/8	0.40	0.46	1.38	0.68	2.56	—	0.41	0.10	
YAZ1CTC12						1/2	0.52	0.46	1.38	0.73	2.81	—	0.53	0.09	
YAZ25TC14	1/0 AWG	—	53.5	Pink	12 or 348	1/4	0.27	0.51	1.38	0.75	2.40	—	0.31	0.12	1-7/16
YAZ25TC516						5/16	0.33	0.51	1.38	0.75	2.46	—	0.34	0.12	
YAZ25TC38						3/8	0.40	0.51	1.38	0.75	2.59	—	0.41	0.12	
YAZ25TC12						1/2	0.52	0.51	1.38	0.75	2.84	—	0.53	0.12	
YAZ26TC14	2/0 AWG	—	70	Black	13	1/4	0.27	0.56	1.50	0.83	2.56	—	0.31	0.12	1-9/16
YAZ26TC38						3/8	0.40	0.56	1.50	0.83	2.75	—	0.41	0.12	
YAZ26TC12						1/2	0.52	0.56	1.50	0.83	3.00	—	0.53	0.12	

*** The MMP conductor sizes listed are the recommendations for Class 2 conductor

◆ For applications greater than 2000 volts consult cable manufacturer for voltage stress relief instructions

Notes: All dimensions shown are for reference only.

Field bending straight lugs to achieve an angular connection will void UL Listing / CSA Certifications and BURNDY will not be liable for the connection.

Compression Connections

Copper Compression — Terminal — Code — One Hole
Long Barrel — with Inspection Window

TYPES YAZ (Continued)

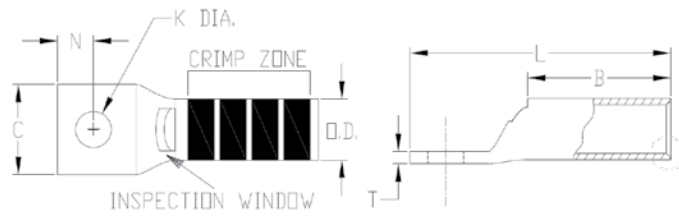

▲ See Copper Code Long Barrel Terminal Tooling Tables in this section for complete tool and die listing information.

Catalog Number	Conductor			Color Code	Die Index	Stud Size	Figure Dimensions								Wire Strip Length
	Code	Flex	Metric MM ² ***				Stud Hole Diameter (K)	Outside Diameter (OD)	Barrel Length (B)	Pad Width (C)	Overall Length (L)	Hole Spacing (E) & (F)	Hole Offset (N)	Pad Thickness (T)	
YAZ27TC38	3/0 AWG	—	—	Orange	14	3/8	0.41	0.62	1.50	0.90	2.79	—	0.41	0.12	1-9/16
YAZ27TC12						1/2	0.52	0.62	1.50	0.90	3.04	—	0.53	0.12	
YAZ28TC38	4/0 AWG	—	—	Purple	15	3/8	0.40	0.69	1.62	1.02	2.95	—	0.41	0.14	1-11/16
YAZ28TC12						1/2	0.52	0.69	1.62	1.02	3.20	—	0.53	0.14	
YAZ29TC38	250 kcmil	—	—	Yellow	16	3/8	0.40	0.75	1.62	1.10	2.98	—	0.41	0.16	1-11/16
YAZ29TC12						1/2	0.52	0.75	1.62	1.10	3.23	—	0.53	0.16	
YAZ30TC38	300 kcmil	—	150	White	17 or 298	3/8	0.40	0.81	2.00	1.20	3.41	—	0.41	0.16	2-1/16
YAZ30TC12						1/2	0.52	0.81	2.00	1.20	3.66	—	0.53	0.16	
YAZ31TC38	350 kcmil	—	185	Red	18 or 324	3/8	0.40	0.88	2.00	1.29	3.44	—	0.41	0.18	2-1/16
YAZ31TC12						1/2	0.52	0.88	2.00	1.29	3.69	—	0.53	0.18	
YAZ32TC38	400 kcmil	—	—	Blue	19 or 470	3/8	0.40	0.95	2.12	1.40	3.61	—	0.41	0.19	2-3/16
YAZ32TC12						1/2	0.52	0.95	2.12	1.40	3.86	—	0.53	0.19	
YAZ33TC12	450 kcmil	—	—	Gray	326 or 538	1/2	0.52	1.01	2.12	1.48	3.95	—	0.53	0.21	2-5/16
YAZ34TC38	500 kcmil	—	240	Brown	20 or 299	3/8	0.40	1.06	2.25	1.55	3.84	—	0.41	0.23	2-5/16
YAZ34TC12						1/2	0.52	1.06	2.25	1.55	4.10	—	0.53	0.23	
YAZ35TC12	550 kcmil	—	—	Yellow	21	1/2	0.52	1.12	2.62	1.65	4.50	—	0.53	0.25	2-11/16
YAZ36TC38	600 kcmil	—	300	Green	22 or 472	3/8	0.40	1.19	2.69	1.74	4.54	—	0.50	0.26	2-3/4
YAZ36TC12						1/2	0.52	1.19	2.69	1.74	4.60	—	0.53	0.26	
YAZ37TC12	650 kcmil	—	—	Orange	23	1/2	0.52	1.23	2.81	1.80	4.75	—	0.53	0.27	2-7/8
YAZ38TC12	700 kcmil	—	—	Pink	400	1/2	0.52	1.25	2.81	1.84	4.77	—	0.53	0.27	2-7/8
YAZ39TC38	750 kcmil	—	—	Black	24	3/8	0.40	1.30	2.88	1.91	4.81	—	0.50	0.27	2-15/16
YAZ39NT12						1/2	0.52	1.30	2.88	1.63	4.87	—	0.53	0.27	
YAZ39TC12						1/2	0.52	1.30	2.88	1.91	4.87	—	0.53	0.27	

*** The MM² conductor sizes listed are the recommendations for Class 2 conductor

◆ For applications greater than 2000 volts consult cable manufacturer for voltage stress relief instructions

Notes: All dimensions shown are for reference only.

Field bending straight lugs to achieve an angular connection will void UL Listing / CSA Certifications and BURNDY will not be liable for the connection.

TYPE YAZ (Continued)

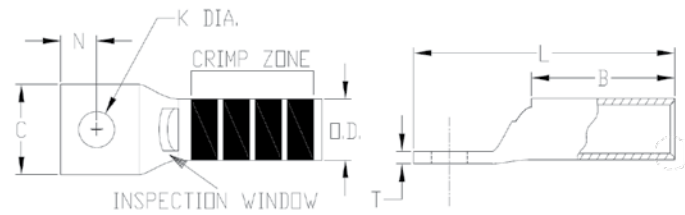

▲ See Copper Code Long Barrel Terminal Tooling Tables in this section for complete tool and die listing information.

Catalog Number	Conductor			Color Code	Die Index	Stud Size	Figure Dimensions								Wire Strip Length
	Code	Flex	Metric MM ² ***				Stud Hole Diameter (K)	Outside Diameter (OD)	Barrel Length (B)	Pad Width (C)	Overall Length (L)	Hole Spacing (E & F)	Hole Offset (N)	Pad Thickness (T)	
YAZ40TC12	800 kcmil	—	400	Orange	25	1/2	0.52	1.35	2.94	1.98	4.94	—	0.53	0.30	3
YAZ41TC12	850 kcmil	—	—	Gold	26	1/2	0.52	1.38	2.94	2.01	4.96	—	0.53	0.31	3
YAZ44TC38	1000 kcmil	—	500	White	27	3/8	0.40	1.50	3.00	2.19	5.08	—	0.50	0.33	3-1/16
YAZ44TC12						1/2	0.52	1.50	3.00	2.19	5.14	—	0.53	0.33	
YAZ45TC12	1250 kcmil	—	—	Yellow	29	1/2	0.52	1.69	3.19	2.46	5.43	—	0.53	0.38	3-1/4
YAZ453TC12	1300 kcmil	—	—	Orange	30	1/2	0.52	1.74	3.19	2.53	5.46	—	0.53	0.39	3-1/4
YAZ46TC12	1500 kcmil	—	—	Green	31	1/2	0.52	1.84	3.19	2.69	5.53	—	0.53	0.40	3-1/4
YAZ47TC12	1750 kcmil	—	—	Gray	33	1/2	0.52	1.98	3.44	2.90	5.87	—	0.53	0.42	3-1/2
YAZ48TC12	2000 kcmil	—	1000	Brown	34	1/2	0.52	2.12	3.44	3.10	5.95	—	0.53	0.46	3-1/2

*** The MM² conductor sizes listed are the recommendations for Class 2 conductor

◆ For applications greater than 2000 volts consult cable manufacturer for voltage stress relief instructions

Notes: All dimensions shown are for reference only.

Field bending straight lugs to achieve an angular connection will void UL Listing / CSA Certifications and BURNDY will not be liable for the connection.

Compression Connections

Copper Compression — Terminal — Code — One Hole
Long Barrel — No Inspection Window

TYPES YA, YA-TC

HYLUG™

Uninsulated Copper Compression Terminal
UL Listed 90° C, Up to 35 kV ♦

45° and 90° angles available. Please contact Customer Service to order:
1-800-346-4175

Features & Benefits

- No inspection window is ideal for more corrosive environments as the barrel transition is not open
- Barrel is designed with an internal chamfer at the wire entry to ensure smooth insertion of the wire, preventing possible damaging of the strands
- Long barrel allows for an increased number of crimps which will increase the mechanical strength of the connection
- 45° and 90° angular lugs are available; please contact Customer Service
- Electro-tin plated unless otherwise specified to reduce galvanic corrosion (bimetallic) and resist corrosive elements
- Connectors are clearly marked with stamping and barrel color coding
- BURNDY certifies its products using the BURNDY Engineered System and select other crimp tool manufacturers in accordance with one or more of the UL categories in order to obtain a UL Listing
- Terminals and splices accommodating code wire: Accommodates Code Class B (Concentric, Compressed, Compact) and Class C wire

Accessories

- Hardware - Section F
- PENETROX™ Oxide Inhibitor - Section F
- Heat and Cold Shrink Tubing - Section D
- WIREMIKE™ Wire Micrometer - Section F
- Wire Management (Cable Ties) - Section G

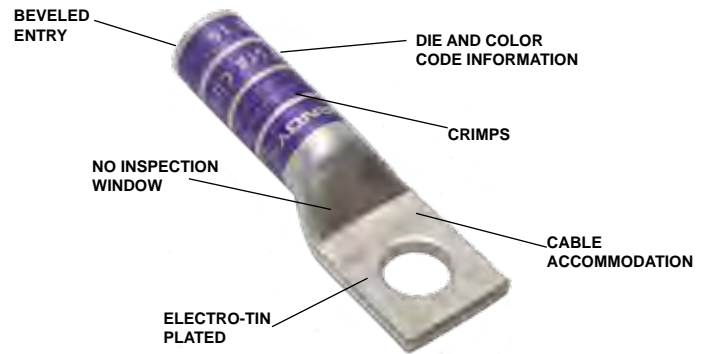

NOTE: Field bending straight lugs to achieve an angular connection will void UL Listing / CSA Certifications and BURNDY will not be liable for the connection.

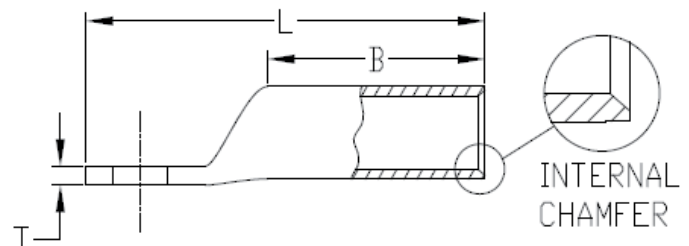
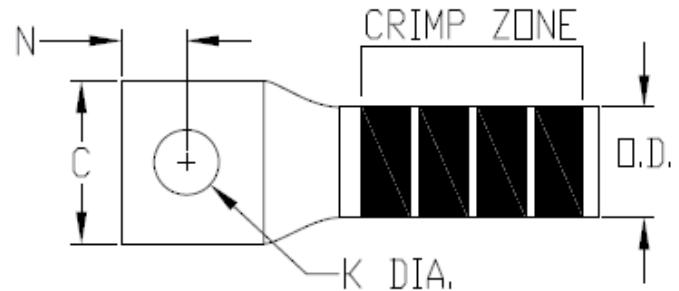

TYPES YA, YA-TC (Continued)

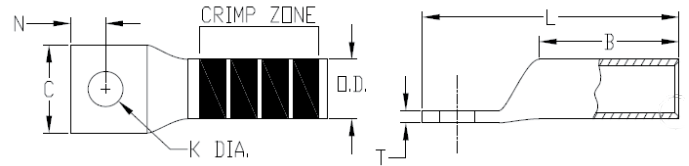

▲ See Copper Code Long Barrel Terminal Tooling Tables in this section for complete tool and die listing information.

Catalog Number	Conductor			Color Code	Die Index	Stud Size	Figure Dimensions								Wire Strip Length
	Code	Flex	Metric MM ² ***				Stud Hole Diameter (K)	Outside Diameter (OD)	Barrel Length (B)	Pad Width (C)	Overall Length (L)	Hole Spacing (E) & (F)	Hole Offset (N)	Pad Thickness (T)	
YA8CTC10	8 AWG	#8 G,H,I,K,M DLO	10	Red	49	#10	0.21	0.27	0.81	0.41	1.57	—	0.25	0.08	7/8
YA8CTC14						1/4	0.27	0.27	0.81	0.44	1.69	—	0.31	0.08	
YA8CTC38						3/8	0.40	0.27	0.81	0.58	1.88	—	0.41	0.06	
YA6CTC8	6 AWG 6 Solid	—	—	Blue	7 or 374	#8	0.18	0.29	1.12	0.42	1.83	—	0.22	0.09	1-3/16
YA6CTC10						#10	0.21	0.29	1.12	0.42	1.89	—	0.25	0.09	
YA6C						1/4	0.27	0.29	1.12	0.41	1.81	—	0.25	0.09	
YA6CN						1/2	0.56	0.29	1.12	0.83	2.64	—	0.63	0.12	
YA6CTC516						5/16	0.33	0.29	1.12	0.52	2.08	—	0.34	0.07	
YA6CTC38	3/8	0.41	0.29	1.12	0.58	2.21	—	0.41	0.06						
YA5C	5 AWG	—	—	Blue	7 or 374	1/4	0.27	0.30	1.12	0.44	1.98	—	0.25	0.07	1-3/16
YA5CN						1/2	0.56	0.30	1.12	0.83	2.67	—	0.63	0.12	
YA4CTC10	4 AWG	—	—	Gray	8 or 346	#10	0.21	0.34	1.12	0.50	1.94	—	0.25	0.09	1-3/16
YA4C						1/4	0.27	0.34	1.12	0.50	1.87	—	0.25	0.09	
YA4CTC38						3/8	0.40	0.34	1.12	0.58	2.25	—	0.41	0.08	
YA4CN						1/2	0.56	0.34	1.12	0.83	2.69	—	0.63	0.12	
YA3CTC14	3 AWG 2 Solid	—	25	White	9	1/4	0.27	0.38	1.25	0.55	2.23	—	0.31	0.09	1-5/16
YA3C						5/16	0.33	0.38	1.25	0.55	2.30	—	0.34	0.09	
YA3CTC38						3/8	0.40	0.38	1.25	0.58	2.42	—	0.41	0.08	
YA3CN						1/2	0.56	0.38	1.25	0.83	2.86	—	0.63	0.12	
YA2CTC10	2 AWG	—	35	Brown	10	#10	0.21	0.42	1.25	0.60	2.10	—	0.25	0.11	1-5/16
YA2CTC14						1/4	0.27	0.42	1.25	0.60	2.23	—	0.31	0.11	
YA2C						5/16	0.33	0.42	1.25	0.60	2.29	—	0.34	0.11	
YA2CTC38						3/8	0.41	0.42	1.25	0.60	2.41	—	0.41	0.11	
YA2CN						1/2	0.56	0.42	1.25	0.83	2.88	—	0.63	0.12	
YA1CTC10	1 AWG	—	50	Green	11	#10	0.21	0.46	1.38	0.68	2.27	—	0.25	0.10	1-7/16
YA1CTC14						1/4	0.27	0.46	1.38	0.68	2.39	—	0.31	0.10	
YA1C						5/16	0.33	0.46	1.38	0.68	2.45	—	0.34	0.10	
YA1CTC38						3/8	0.41	0.46	1.38	0.68	2.58	—	0.41	0.10	
YA1CN						1/2	0.56	0.46	1.38	0.83	3.06	—	0.63	0.12	

* Available undrilled. Add suffix "U" to the catalog number (example: YA25U)

*** The MM² conductor sizes listed are the recommendations for Class 2 conductor

◆ For applications greater than 2000 volts consult cable manufacturer for voltage stress relief instructions

Notes: All dimensions shown are for reference only.

Field bending straight lugs to achieve an angular connection will void UL Listing / CSA Certifications and BURNDY will not be liable for the connection.

Compression Connections

Copper Compression — Terminal — Code — One Hole
Long Barrel — No Inspection Window

TYPES YA, YA-TC (Continued)

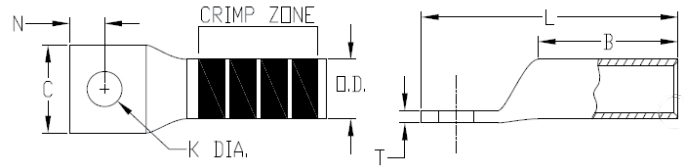

▲ See Copper Code Long Barrel Terminal Tooling Tables in this section for complete tool and die listing information.

Catalog Number	Conductor			Color Code	Die Index	Stud Size	Figure Dimensions								Wire Strip Length
	Code	Flex	Metric MM ² ***				Stud Hole Diameter (K)	Outside Diameter (OD)	Barrel Length (B)	Pad Width (C)	Overall Length (L)	Hole Spacing (E) & (F)	Hole Offset (N)	Pad Thickness (T)	
YA25TC10	1/0 AWG	—	—	Pink	12	#10	0.21	0.51	1.38	0.75	2.30	—	0.25	0.12	1-7/16
YA25						5/16	0.33	0.51	1.38	0.75	2.48	—	0.34	0.13	
YA25TC38						3/8	0.40	0.51	1.38	0.75	2.61	—	0.41	0.12	
YA25N						1/2	0.56	0.51	1.38	0.83	3.05	—	0.63	0.11	
YA26TC14	2/0 AWG	—	70	Black	13	1/4	0.27	0.56	1.50	0.83	2.58	—	0.31	0.12	1-9/16
YA26TC516						5/16	0.33	0.56	1.50	0.83	2.65	—	0.34	0.12	
YA26						3/8	0.40	0.56	1.50	0.83	2.77	—	0.41	0.12	
YA26N						1/2	0.56	0.56	1.50	0.83	3.21	—	0.63	0.12	
YA27	3/0 AWG	—	—	Orange	14	1/2	0.53	0.62	1.50	0.91	3.06	—	0.53	0.13	1-9/16
YA28TC38	4/0 AWG	—	—	Purple	15	3/8	0.40	0.69	1.62	1.02	2.98	—	0.41	0.14	1-11/16
YA28						1/2	0.53	0.69	1.62	1.02	3.23	—	0.53	0.14	
YA28N						1/2	0.56	0.69	1.62	1.02	3.41	—	0.63	0.14	
YA29	250 kcmil	—	—	Yellow	16	1/2	0.53	0.75	1.62	1.11	3.26	—	0.53	0.16	1-11/16
YA30	300 kcmil	—	150	White	17 or 298	1/2	0.53	0.81	2.00	1.20	3.69	—	0.53	0.16	2-1/16
YA30N						1/2	0.58	0.81	2.00	1.20	3.88	—	0.63	0.16	
YA31	350 kcmil	—	185	Red	18 or 324	1/2	0.53	0.88	2.00	1.29	3.73	—	0.53	0.18	2-1/16
YA32N	400 kcmil	—	—	Blue	19 or 470	1/2	0.56	0.95	2.12	1.40	4.09	—	0.63	0.19	2-3/16
YA32						5/8	0.69	0.95	2.12	1.40	4.15	—	0.66	0.19	
YA33N	450 kcmil	—	—	Gray	326 or 538	1/2	0.56	1.01	2.13	1.48	4.17	—	0.63	0.21	2-5/16
YA33						5/8	0.69	1.01	2.13	1.48	4.24	—	0.66	0.21	
YA34N	500 kcmil	—	240	Brown	20 or 299	1/2	0.56	1.06	2.25	1.55	4.32	—	0.63	0.23	2-5/16
YA34						5/8	0.69	1.06	2.25	1.55	4.39	—	0.66	0.23	
YA36N	600 kcmil	—	300	Green	22 or 472	1/2	0.56	1.19	2.69	1.74	4.83	—	0.63	0.27	2-3/4
YA36						5/8	0.69	1.19	2.69	1.74	4.90	—	0.66	0.27	
YA37N	650 kcmil	—	—	Orange	23	1/2	0.56	1.23	2.81	1.80	4.98	—	0.63	0.27	2-7/8
YA37						5/8	0.69	1.23	2.81	1.80	5.05	—	0.66	0.27	
YA38N	700 kcmil	—	—	Pink	400	1/2	0.56	1.25	2.81	1.84	5.01	—	0.63	0.27	2-7/8
YA38						5/8	0.69	1.25	2.81	1.84	5.07	—	0.66	0.27	

* Available undrilled. Add suffix "U" to the catalog number (example: YA25U)

*** The MM² conductor sizes listed are the recommendations for Class 2 conductor

◆ For applications greater than 2000 volts consult cable manufacturer for voltage stress relief instructions

Notes: All dimensions shown are for reference only.

Field bending straight lugs to achieve an angular connection will void UL Listing / CSA Certifications and BURNDY will not be liable for the connection.

TYPES YA, YA-TC (Continued)

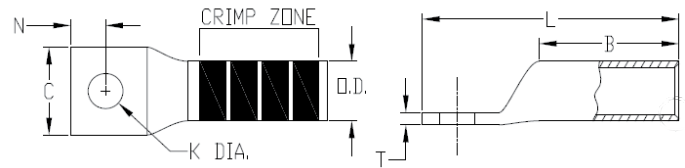

▲ See Copper Code Long Barrel Terminal Tooling Tables in this section for complete tool and die listing information.

Catalog Number	Conductor			Color Code	Die Index	Stud Size	Figure Dimensions								Wire Strip Length
	Code	Flex	Metric MM ² ***				Stud Hole Diameter (K)	Outside Diameter (OD)	Barrel Length (B)	Pad Width (C)	Overall Length (L)	Hole Spacing (E) & (F)	Hole Offset (N)	Pad Thickness (T)	
YA39N	750 kcmil	—	—	Black	24	1/2	0.56	1.30	2.88	1.91	5.11	—	0.63	0.27	2-15/16
YA39						5/8	0.69	1.30	2.88	1.91	5.17	—	0.66	0.27	
YA40	800 kcmil	—	400	Orange	25	5/8	0.69	1.35	2.94	1.98	5.25	—	0.66	0.30	3
YA41N	850 kcmil	—	—	Gold	26	1/2	0.56	1.38	2.94	2.01	5.20	—	0.63	0.31	3
YA41						5/8	0.69	1.38	2.94	2.01	5.26	—	0.66	0.31	
YA44N	1000 kcmil	—	500	White	27	1/2	0.56	1.50	3.00	2.19	5.38	—	0.63	0.33	3-1/16
YA44						5/8	0.69	1.50	3.00	2.19	5.45	—	0.66	0.33	
YA45	1250 kcmil	—	—	Yellow	29	3/4	0.81	1.69	3.19	2.46	5.93	—	0.75	0.38	3-1/4
YA46N	1500 kcmil	—	—	Green	31	1/2	0.56	1.84	3.19	2.69	5.79	—	0.63	0.40	3-5/16
YA46						3/4	0.81	1.84	3.19	2.69	6.04	—	0.75	0.40	
YA47N	1750 kcmil	—	—	Gray	33	1/2	0.56	1.98	3.44	2.90	6.13	—	0.63	0.46	3-1/2
YA47						3/4	0.81	1.98	3.44	2.90	6.38	—	0.75	0.46	
YA48N	2000 kcmil	—	1000	Brown	34	1/2	0.56	2.13	3.44	3.10	6.22	—	0.63	0.46	3-1/2
YA48						3/4	0.81	2.13	3.44	3.10	6.47	—	0.75	0.46	

* Available undrilled. Add suffix "U" to the catalog number (example: YA25U)

*** The MM² conductor sizes listed are the recommendations for Class 2 conductor

◆ For applications greater than 2000 volts consult cable manufacturer for voltage stress relief instructions

Notes: All dimensions shown are for reference only.

Field bending straight lugs to achieve an angular connection will void UL Listing / CSA Certifications and BURNDY will not be liable for the connection.

TYPES YAZ-2N, YAZ-2TC

HYLUG™

Uninsulated Copper Compression Terminal
UL Listed 90° C, Up to 35 kV ♦

45° and 90° angles available. Please contact Customer Service to order:
1-800-346-4175

Features & Benefits

- Inspection window allows for visual verification that the wire has been fully inserted prior to crimping the lug
- Barrel is designed with an internal chamfer at the wire entry to ensure smooth insertion of the wire, preventing possible damaging of the strands
- Long barrel allows for an increased number of crimps which will increase the mechanical strength of the connection
- Two hole tongue/tang is recommended when space permits as the 2-hole feature minimizes the terminations from loosening or rotating under vibration, movement, or heat cycling
- 45° and 90° angular lugs are available; please contact Customer Service
- Electro-tin plated unless otherwise specified to reduce galvanic corrosion (bimetallic) and resist corrosive elements
- Connectors are clearly marked with stamping and barrel color coding
- BURNDY certifies its products using the BURNDY Engineered System and select other crimp tool manufacturers in accordance with one or more of the UL categories in order to obtain a UL Listing
- Terminals and splices accommodating code wire: Accommodates Code Class B (Concentric, Compressed, Compact) and Class C wire

Accessories

- Hardware - Section F
- PENETROX™ Oxide Inhibitor - Section F
- Heat and Cold Shrink Tubing - Section D
- WIREMIKE™ Wire Micrometer - Section F
- Wire Management (Cable Ties) - Section G

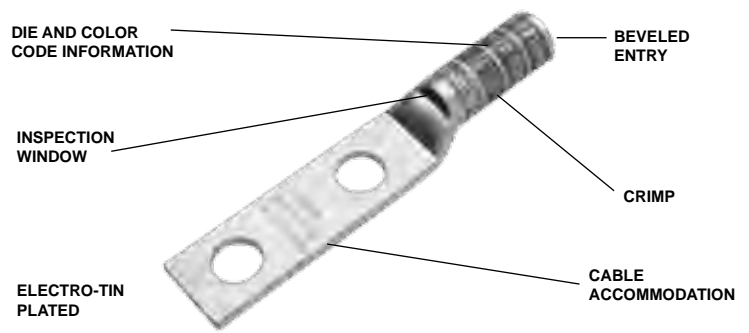

NOTE: Field bending straight lugs to achieve an angular connection will void UL Listing / CSA Certifications and BURNDY will not be liable for the connection.

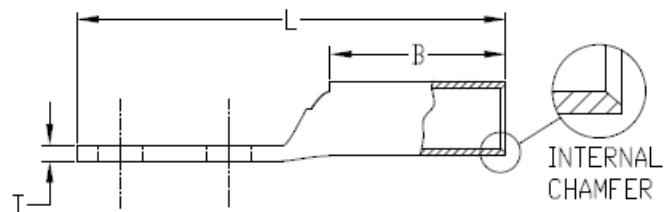
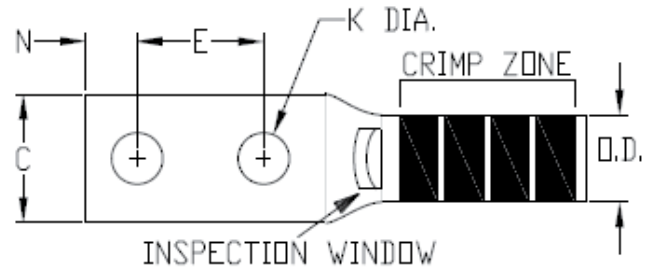

TYPES YAZ-2N, YAZ-2TC (Continued)

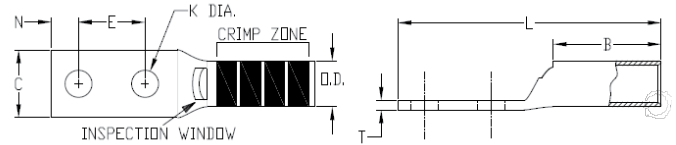

▲ See Copper Code Long Barrel Terminal Tooling Tables in this section for complete tool and die listing information.

Catalog Number	Conductor			Color Code	Die Index	Stud Size	Figure Dimensions								Wire Strip Length
	Code	Flex	Metric MM ² ***				Stud Hole Diameter (K)	Outside Diameter (OD)	Barrel Length (B)	Pad Width (C)	Overall Length (L)	Hole Spacing (E & F)	Hole Offset (N)	Pad Thickness (T)	
YAZV102TC14	14-10 AWG	—	6	—	—	1/4	0.27	0.21	0.69	0.41	2.16	5/8	0.31	0.05	3/4
YAZV102TC14E2						1/4	0.27	0.21	0.69	0.41	2.28	3/4	0.31	0.05	
YAZ8C2TC10	8 AWG	#8 G,H,I,K,M DLO	10	Red	49	#10	0.21	0.27	0.75	0.41	2.07	5/8	0.25	0.08	7/8
YAZ8C2TC10E2						#10	0.21	0.27	0.75	0.41	2.19	3/4	0.25	0.08	
YAZ8C2TC14						1/4	0.27	0.27	0.75	0.44	2.19	5/8	0.31	0.08	
YAZ8C2TC14E2						1/4	0.27	0.27	0.75	0.44	2.32	3/4	0.31	0.08	
YAZ8C2TC14E1						1/4	0.27	0.27	0.75	0.44	2.57	1	0.31	0.08	
YAZ8C2TC38						3/8	0.41	0.27	0.75	0.58	2.76	1	0.41	0.06	
YAZ6C2TC10E2						6 AWG 6 Sol	—	—	Blue	7 or 374	#10	0.21	0.29	1.12	
YAZ6C2TC14	1/4	0.27	0.29	1.12	0.45						2.65	5/8	0.31	0.08	
YAZ6C2TC14E2	1/4	0.27	0.29	1.12	0.45						2.78	3/4	0.31	0.08	
YAZ6C2TC14E1	1/4	0.27	0.29	1.12	0.45						3.03	1	0.31	0.08	
YAZ6C2TC38E2	3/8	0.40	0.29	1.12	0.58						2.97	3/4	0.41	0.06	
YAZ6C2TC38E6	3/8	0.40	0.29	1.12	0.58						3.09	7/8	0.41	0.06	
YAZ6C2TC38	3/8	0.40	0.29	1.12	0.58						3.22	1	0.41	0.06	
YAZ6C2TC38E16	3/8	0.40	0.29	1.12	0.58						3.97	1-3/4	0.41	0.06	
YAZ6C2N	1/2	0.56	0.29	1.12	0.83						4.40	1-3/4	0.63	0.12	
YAZ5C2N	5 AWG	—	—	Blue	7 or 374	1/2	0.56	0.30	1.12	0.83	4.43	1-3/4	0.63	0.12	1-3/16
YAZ4C2TC10E2	4 AWG	—	—	Gray	8 or 346	#10	0.21	0.34	1.12	0.50	2.67	3/4	0.25	0.09	1-3/16
YAZ4C2TC14						1/4	0.27	0.34	1.12	0.50	2.67	5/8	0.31	0.09	
YAZ4C2TC14E2						1/4	0.27	0.34	1.12	0.50	2.80	3/4	0.31	0.09	
YAZ4C2TC38						3/8	0.40	0.34	1.12	0.58	3.23	1	0.41	0.08	
YAZ4C2N						1/2	0.56	0.34	1.12	0.83	4.45	1-3/4	0.63	0.12	
YAZ3C2TC14	3 AWG 2 Sol	—	25	White	9	1/4	0.27	0.38	1.25	0.55	2.83	5/8	0.31	0.09	1-5/16
YAZ3C2TC14E2						1/4	0.27	0.38	1.25	0.55	2.95	3/4	0.31	0.09	
YAZ3C2TC38E2						3/8	0.40	0.38	1.25	0.58	3.14	3/4	0.41	0.08	
YAZ3C2TC38						3/8	0.40	0.38	1.25	0.58	3.39	1	0.41	0.08	
YAZ3C2N						1/2	0.56	0.38	1.25	0.83	4.62	1-3/4	0.63	0.12	

*** The MM² conductor sizes listed are the recommendations for Class 2 conductor

◆ For applications greater than 2000 volts consult cable manufacturer for voltage stress relief instructions

Notes: All dimensions shown are for reference only.

Field bending straight lugs to achieve an angular connection will void UL Listing / CSA Certifications and BURNDY will not be liable for the connection.

Compression Connections

Copper Compression — Terminal — Code — Two Hole
Long Barrel — with Inspection Window

TYPES YAZ-2N, YAZ-2TC (Continued)

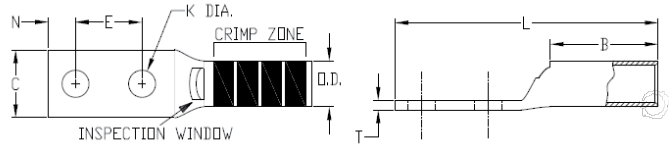

▲ See Copper Code Long Barrel Terminal Tooling Tables in this section for complete tool and die listing information.

Catalog Number	Conductor			Color Code	Die Index	Stud Size	Figure Dimensions							Wire Strip Length	
	Code	Flex	Metric MM ² ***				Stud Hole Diameter (K)	Outside Diameter (OD)	Barrel Length (B)	Pad Width (C)	Overall Length (L)	Hole Spacing (E & F)	Hole Offset (N)		Pad Thickness (T)
YAZ2C2TC10E2	#2 AWG	—	35	Brown	10	#10	0.21	0.42	1.25	0.60	2.85	3/4	0.25	0.11	1-5/16
YAZ2C2TC14						1/4	0.27	0.42	1.25	0.60	2.85	5/8	0.31	0.11	
YAZ2C2TC14E2						1/4	0.27	0.42	1.25	0.60	2.97	3/4	0.31	0.11	
YAZ2C2TC14E1						1/4	0.27	0.42	1.25	0.60	3.22	1	0.31	0.11	
YAZ2C2TC516E7						5/16	0.33	0.42	1.25	0.60	2.91	5/8	0.34	0.11	
YAZ2C2TC516E2						5/16	0.33	0.42	1.25	0.60	3.03	3/4	0.34	0.11	
YAZ2C2TC38E2						3/8	0.40	0.42	1.25	0.60	3.16	3/4	0.41	0.11	
YAZ2C2TC38E6						3/8	0.40	0.42	1.25	0.60	3.28	7/8	0.41	0.11	
YAZ2C2TC38						3/8	0.40	0.42	1.25	0.60	3.41	1	0.41	0.11	
YAZ2C2NTC38						3/8	0.40	0.42	1.25	0.60	4.16	1-3/4	0.41	0.11	
YAZ2C2N	1/2	0.56	0.42	1.25	0.83	4.64	1-3/4	0.63	0.12						
YAZ1C2TC14	#1 AWG	—	50	Green	11 or 375	1/4	0.27	0.46	1.38	0.67	3.01	5/8	0.31	0.10	1-7/16
YAZ1C2TC14E2						1/4	0.27	0.46	1.38	0.67	3.13	3/4	0.31	0.10	
YAZ1C2TC38						3/8	0.40	0.46	1.38	0.67	3.57	1	0.41	0.10	
YAZ1C2N						1/2	0.56	0.46	1.38	0.83	4.82	1-3/4	0.62	0.12	
YAZ252TC14	1/0 AWG	—	—	Pink	12 or 348	1/4	0.27	0.51	1.38	0.75	3.04	5/8	0.31	0.12	1-7/16
YAZ252TC14E2						1/4	0.27	0.51	1.38	0.75	3.16	3/4	0.31	0.12	
YAZ252TC14E1						1/4	0.27	0.51	1.38	0.75	3.41	1	0.31	0.12	
YAZ252TC14E3						1/4	0.27	0.51	1.38	0.75	3.42	1	0.31	0.12	
YAZ252TC516E6						5/16	0.33	0.51	1.38	0.75	3.35	7/8	0.34	0.12	
YAZ252TC516						5/16	0.33	0.51	1.38	0.75	3.47	1	0.34	0.12	
YAZ252TC38						3/8	0.40	0.51	1.38	0.75	3.60	1	0.41	0.12	
YAZ252NTC38						3/8	0.40	0.51	1.38	0.75	4.35	1-3/4	0.41	0.12	
YAZ252N						1/2	0.56	0.51	1.38	0.83	4.79	1-3/4	0.63	0.11	
YAZ262TC14						2/0 AWG	—	70	Black	13	1/4	0.27	0.56	1.50	
YAZ262TC14E2	1/4	0.27	0.56	1.50	0.83						3.32	3/4	0.31	0.12	
YAZ262TC14E1	1/4	0.27	0.56	1.50	0.83						3.57	1	0.31	0.12	
YAZ262TC38	3/8	0.41	0.56	1.50	0.83						3.76	1	0.41	0.12	
YAZ262TC38E16	3/8	0.41	0.56	1.50	0.83						4.51	1-3/4	0.41	0.12	
YAZ262N	1/2	0.56	0.56	1.50	0.83						4.95	1-3/4	0.62	0.12	
YAZ272TC14E2	3/0 AWG	—	—	Orange	14	1/4	0.27	0.62	1.50	0.90	3.36	3/4	0.31	0.12	1-9/16
YAZ272TC38						3/8	0.40	0.62	1.50	0.90	3.80	1	0.41	0.12	
YAZ272N						1/2	0.56	0.62	1.50	0.91	4.98	1-3/4	0.62	0.12	
YAZ282TC14E2	4/0 AWG	—	—	Purple	15	1/4	0.27	0.69	1.62	1.02	3.55	3/4	0.31	0.14	1-11/16
YAZ282TC38						3/8	0.40	0.69	1.62	1.02	3.99	1	0.41	0.14	
YAZ282NTC38						3/8	0.40	0.69	1.62	1.02	4.74	1-3/4	0.41	0.14	
YAZ282N						1/2	0.56	0.69	1.62	1.02	5.15	1-3/4	0.62	0.14	
YAZ292TC38	250 kcmil	—	—	Yellow	16	3/8	0.40	0.75	1.62	1.10	3.99	1	0.41	0.14	1-11/16
YAZ292N						1/2	0.56	0.75	1.62	1.10	5.18	1-3/4	0.62	0.16	
YAZ302TC38	300 kcmil	—	150	White	17 or 298	3/8	0.40	0.81	2.00	1.20	4.42	1	0.41	0.16	2-1/16
YAZ302N						1/2	0.56	0.81	2.00	1.20	5.60	1-3/4	0.62	0.16	

*** The MM² conductor sizes listed are the recommendations for Class 2 conductor

◆ For applications greater than 2000 volts consult cable manufacturer for voltage stress relief instructions

Notes: All dimensions shown are for reference only.

Field bending straight lugs to achieve an angular connection will void UL Listing / CSA Certifications and BURNDY will not be liable for the connection.

TYPES YAZ-2N, YAZ-2TC (Continued)

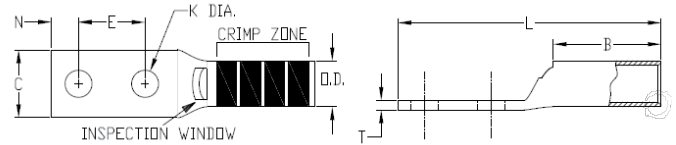

▲ See Copper Code Long Barrel Terminal Tooling Tables in this section for complete tool and die listing information.

Catalog Number	Conductor			Color Code	Die Index	Stud Size	Figure Dimensions									Wire Strip Length
	Code	Flex	Metric MM ² ***				Stud Hole Diameter (K)	Outside Diameter (OD)	Barrel Length (B)	Pad Width (C)	Overall Length (L)	Hole Spacing (E) & (F)	Hole Offset (N)	Pad Thickness (T)		
YAZ312TC14E2	350 kcmil	—	185	Red	18 or 324	1/4	0.27	0.88	2.00	1.29	4.02	3/4	0.31	0.18	2-1/16	
YAZ312TC38						3/8	0.40	0.88	2.00	1.29	4.45	1	0.41	0.18		
YAZ312N						1/2	0.56	0.88	2.00	1.29	5.64	1-3/4	0.62	0.18		
YAZ322TC38	400 kcmil	—	—	Blue	19 or 470	3/8	0.40	0.95	2.12	1.40	4.62	1	0.41	0.19	2-3/16	
YAZ322N						1/2	0.56	0.95	2.12	1.40	5.81	1-3/4	0.62	0.19		
YAZ332N	450 kcmil	—	—	Gray	326 or 538	1/2	0.56	1.01	2.12	1.48	5.89	1-3/4	0.62	0.21	2-5/16	
YAZ342TC14E2	500 kcmil	—	240	Brown	20 or 299	1/4	0.27	1.06	2.25	1.55	4.42	3/4	0.31	0.23	2-5/16	
YAZ342TC38						3/8	0.40	1.06	2.25	1.55	4.85	1	0.41	0.23		
YAZ342N						1/2	0.56	1.06	2.25	1.55	6.04	1-3/4	0.62	0.23		
YAZ352N	550 kcmil	—	—	Yellow	21	1/2	0.56	1.12	2.62	1.65	6.45	1-3/4	0.62	0.25	2-11/16	
YAZ362TC38	600 kcmil	—	300	Green	22 or 472	3/8	0.40	1.19	2.69	1.74	5.55	1	0.50	0.26	2-3/4	
YAZ362N						1/2	0.56	1.19	2.69	1.74	6.55	1-3/4	0.62	0.26		
YAZ372N	650 kcmil	—	—	Orange	23	1/2	0.56	1.23	2.81	1.80	6.70	1-3/4	0.62	0.27	2-7/8	
YAZ382N	700 kcmil	—	—	Pink	400	1/2	0.56	1.25	2.81	1.84	6.72	1-3/4	0.62	0.27	2-7/8	
YAZ392NT38	750 kcmil	—	—	Black	24	3/8	0.40	1.30	2.88	1.63	5.82	1	0.50	0.27	2-15/16	
YAZ392TC38						3/8	0.40	1.30	2.88	1.91	5.82	1	0.50	0.27		
YAZ392N						1/2	0.56	1.30	2.88	1.91	6.82	1-3/4	0.63	0.27		
YAZ392NNT						1/2	0.56	1.30	2.88	1.63	6.82	1-3/4	0.63	0.27		
YAZ402N	800 kcmil	—	400	Orange	25	1/2	0.56	1.35	2.94	1.98	6.89	1-3/4	0.62	0.30	3	
YAZ412N	850 kcmil	—	—	Gold	26	1/2	0.56	1.38	2.94	2.01	6.91	1-3/4	0.62	0.31	3	
YAZ442TC38	1000 kcmil	—	500	White	27	3/8	0.40	1.50	3.00	2.19	6.09	1	0.50	0.33	3-1/16	
YAZ442N						1/2	0.56	1.50	3.00	2.19	7.08	1-3/4	0.62	0.33		
YAZ452N	1250 kcmil	—	—	Yellow	29	1/2	0.56	1.69	3.19	2.46	7.38	1-3/4	0.62	0.38	3-1/4	
YAZ4532N	1300 kcmil	—	—	Orange	30	1/2	0.56	1.74	3.19	2.53	7.41	1-3/4	0.62	0.39	2-1/16	
YAZ462N	1500 kcmil	—	—	Green	31	1/2	0.56	1.84	3.19	2.69	7.48	1-3/4	0.62	0.40	3-5/16	
YAZ472N	1750 kcmil	—	—	Gray	33	1/2	0.56	1.98	3.44	2.90	7.82	1-3/4	0.62	0.42	3-1/2	
YAZ482N	2000 kcmil	—	1000	Brown	34	1/2	0.56	2.12	3.44	3.10	7.89	1-3/4	0.62	0.46	3-1/2	

*** The MM² conductor sizes listed are the recommendations for Class 2 conductor

◆ For applications greater than 2000 volts consult cable manufacturer for voltage stress relief instructions

Notes: All dimensions shown are for reference only.

Field bending straight lugs to achieve an angular connection will void UL Listing / CSA Certifications and BURNDY will not be liable for the connection.

Compression Connections

Copper Compression — Terminal — Code — Two Hole
Long Barrel — No Inspection Window

TYPES YA-2N, YA-2TC, YA-4N

HYLUG™

Uninsulated Copper Compression Terminal
UL Listed 90° C, Up to 35 kV ♦

45° and 90° angles available. Please contact Customer Service to order:
1-800-346-4175

Features & Benefits

- No inspection window is ideal for more corrosive environments as the barrel transition is not open
- Barrel is designed with an internal chamfer at the wire entry to ensure smooth insertion of the wire, preventing possible damaging of the strands
- Long barrel allows for an increased number of crimps which will increase the mechanical strength of the connection
- Two hole tongue/tang is recommended when space permits as the 2-hole feature minimizes the terminations from loosening or rotating under vibration, movement, or heat cycling
- 45° and 90° angular lugs are available; please contact Customer Service
- Electro-tin plated unless otherwise specified to reduce galvanic corrosion (bimetallic) and resist corrosive elements
- Connectors are clearly marked with stamping and barrel color coding
- BURNDY certifies its products using the BURNDY Engineered System and select other crimp tool manufacturers in accordance with one or more of the UL categories in order to obtain a UL Listing
- Terminals and splices accommodating code wire: Accommodates Code Class B (Concentric, Compressed, Compact) and Class C wire

Accessories

- Hardware - Section F
- PENETROX™ Oxide Inhibitor - Section F
- Heat and Cold Shrink Tubing - Section D
- WIREMIKE™ Wire Micrometer - Section F
- Wire Management (Cable Ties) - Section G

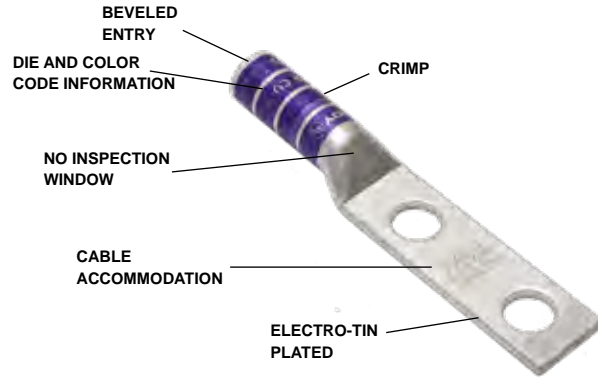

NOTE: Field bending straight lugs to achieve an angular connection will void UL Listing / CSA Certifications and BURNDY will not be liable for the connection.

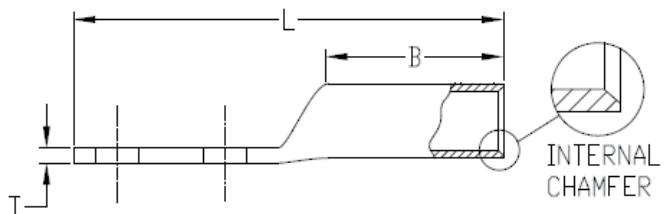
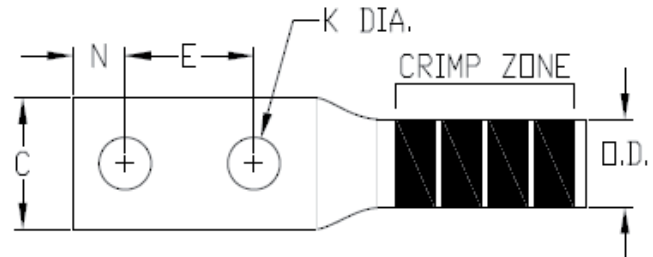

TYPES YA-2N, YA-2TC, YA-4N (Continued)

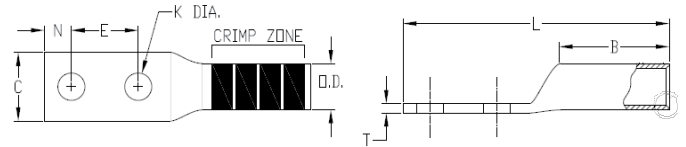

▲ See Copper Code Long Barrel Terminal Tooling Tables in this section for complete tool and die listing information.

Catalog Number	Conductor			Color Code	Die Index	Stud Size	Figure Dimensions								Wire Strip Length
	Code	Flex	Metric MM ² ***				Stud Hole Diameter (K)	Outside Diameter (OD)	Barrel Length (B)	Pad Width (C)	Overall Length (L)	Hole Spacing (E) & (F)	Hole Offset (N)	Pad Thickness (T)	
YA8C2TC14	8 AWG	#8 G,H,I,K,M DLO	10	Red	49	1/4	0.27	0.27	0.81	0.44	2.33	5/8"	0.31	0.08	7/8
YA8C2TC14E2						1/4	0.27	0.27	0.81	0.44	2.45	3/4"	0.31	0.08	
YA8C2TC38						3/8	0.41	0.27	0.81	0.58	2.89	1"	0.41	0.06	
YA8C2N						1/2	0.56	0.27	0.81	0.83	4.08	1-3/4"	0.63	0.12	
YA6C2TC14	6 AWG 6 SOL	—	—	Blue	7 or 374	1/4	0.27	0.29	1.12	0.45	2.65	5/8"	0.31	0.08	1-3/16
YA6C2TC14E2						1/4	0.27	0.29	1.12	0.45	2.78	3/4"	0.31	0.08	
YA6C2TC14E1						1/4	0.27	0.29	1.12	0.45	3.03	1"	0.31	0.08	
YA6C2TC38E2						3/8	0.41	0.29	1.12	0.58	2.97	3/4"	0.41	0.06	
YA6C2TC38E6						3/8	0.41	0.29	1.12	0.58	3.09	7/8"	0.41	0.06	
YA6C2TC38						3/8	0.41	0.29	1.12	0.58	3.22	1"	0.41	0.06	
YA6C2N	1/2	0.56	0.29	1.12	0.83	4.40	1-3/4"	0.63	0.12						
YA5C2N	5 AWG	—	—	Blue	7 or 374	1/2	0.56	0.30	1.12	0.83	4.43	1-3/4"	0.63	0.12	1-3/16
YA4C2TC14	4 AWG	—	—	Gray	8 or 346	1/4	0.27	0.34	1.12	0.50	2.70	5/8"	0.31	0.09	1-3/16
YA4C2TC14E2						1/4	0.27	0.34	1.12	0.50	2.83	3/4"	0.31	0.09	
YA4C2TC38						3/8	0.41	0.34	1.12	0.58	3.26	1"	0.41	0.08	
YA4C2N						1/2	0.56	0.34	1.12	0.83	4.45	1-3/4"	0.63	0.12	
YA3C2TC14	3 AWG 2 SOL	—	25	White	9	1/4	0.27	0.38	1.25	0.55	2.87	5/8"	0.31	0.09	1-5/16
YA3C2TC14E2						1/4	0.27	0.38	1.25	0.55	2.99	3/4"	0.31	0.09	
YA3C2TC38E2						3/8	0.40	0.38	1.25	0.58	3.18	3/4"	0.41	0.08	
YA3C2TC38						3/8	0.40	0.38	1.25	0.58	3.43	1"	0.41	0.08	
YA3C2N						1/2	0.56	0.38	1.25	0.83	4.62	1-3/4"	0.63	0.12	
YA2C2TC14	2 AWG	—	35	Brown	10	1/4	0.27	0.42	1.25	0.60	2.86	5/8"	0.31	0.11	1-5/16
YA2C2TC14E2						1/4	0.27	0.42	1.25	0.60	2.98	3/4"	0.31	0.11	
YA2C2TC516E2						5/16	0.33	0.42	1.25	0.60	3.05	3/4"	0.34	0.11	
YA2C2TC38E2						3/8	0.40	0.42	1.25	0.60	3.17	3/4"	0.41	0.11	
YA2C2TC38E6						3/8	0.40	0.42	1.25	0.60	3.30	7/8"	0.41	0.11	
YA2C2TC38						3/8	0.40	0.42	1.25	0.60	3.42	1"	0.41	0.11	
YA2C2NTC38						3/8	0.40	0.42	1.25	0.60	4.17	1-3/4"	0.41	0.11	
YA2C2N						1/2	0.56	0.42	1.25	0.83	4.64	1-3/4"	0.63	0.12	

*** The MM² conductor sizes listed are the recommendations for Class 2 conductor

◆ For applications greater than 2000 volts consult cable manufacturer for voltage stress relief instructions

Available undrilled. Add suffix U to catalog number (example: YA25U)

Notes: All dimensions shown are for reference only.

Field bending straight lugs to achieve an angular connection will void UL Listing / CSA Certifications and BURNDY will not be liable for the connection.

Compression Connections

Copper Compression — Terminal — Code — Two Hole
Long Barrel — No Inspection Window

TYPES YA-2N, YA-2TC, YA-4N (Continued)

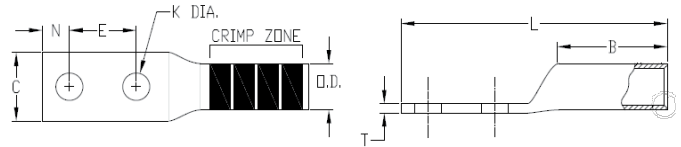

▲ See Copper Code Long Barrel Terminal Tooling Tables in this section for complete tool and die listing information.

Catalog Number	Conductor			Color Code	Die Index	Stud Size	Figure Dimensions							Wire Strip Length	
	Code	Flex	Metric MM ² ***				Stud Hole Diameter (K)	Outside Diameter (OD)	Barrel Length (B)	Pad Width (C)	Overall Length (L)	Hole Spacing (E) & (F)	Hole Offset (N)		Pad Thickness (T)
YA1C2TC14	#1 AWG	—	50	Green	11 or 375	1/4	0.27	0.46	1.38	0.67	3.03	5/8"	0.31	0.10	1-7/16
YA1C2TC14E2						1/4	0.27	0.46	1.38	0.67	3.15	3/4"	0.31	0.10	
YA1C2TC38						3/8	0.40	0.46	1.38	0.67	3.59	1"	0.41	0.10	
YA1C2N						1/2	0.56	0.46	1.38	0.83	4.82	1-3/4"	0.63	0.12	
YA252TC14	1/0 AWG	—	—	Pink	12	1/4	0.27	0.51	1.38	0.75	3.05	5/8"	0.12	0.12	1-7/16
YA252TC14E2						1/4	0.27	0.51	1.38	0.75	3.18	3/4"	0.12	0.12	
YA252TC516						5/16	0.33	0.51	1.38	0.75	3.49	1"	0.12	0.12	
YA252TC38						3/8	0.40	0.51	1.38	0.75	3.62	1"	0.12	0.12	
YA252NTC38						3/8	0.40	0.51	1.38	0.75	4.37	1-3/4"	0.12	0.12	
YA252N	1/2	0.56	0.51	1.38	0.83	4.81	1-3/4"	0.11	0.11						
YA262TC14	2/0 AWG	—	70	Black	13	1/4	0.27	0.56	1.50	0.83	3.22	5/8"	0.12	0.12	1-9/16
YA262TC14E2						1/4	0.27	0.56	1.50	0.83	3.34	3/4"	0.12	0.12	
YA262TC38						3/8	0.40	0.56	1.50	0.83	3.78	1"	0.12	0.12	
YA262N						1/2	0.56	0.56	1.50	0.83	4.97	1-3/4"	0.12	0.12	
YA272TC14E2	3/0 AWG	—	—	Orange	14	1/4	0.27	0.62	1.50	0.90	3.38	3/4"	0.12	0.12	1-9/16
YA272TC38						3/8	0.40	0.62	1.50	0.90	3.82	1"	0.12	0.12	
YA272N						1/2	0.56	0.62	1.50	0.91	5.01	1-3/4"	0.13	0.13	
YA282TC14E2	4/0 AWG	—	—	Purple	15	1/4	0.27	0.69	1.62	1.02	3.55	3/4"	0.14	0.14	1-11/16
YA282TC38						3/8	0.40	0.69	1.62	1.02	3.99	1"	0.14	0.14	
YA282NTC38						3/8	0.40	0.69	1.62	1.02	4.74	1-3/4"	0.14	0.14	
YA282N						1/2	0.56	0.69	1.62	1.02	5.17	1-3/4"	0.14	0.14	
YA292TC38	250 kcmil	—	—	Yellow	16	3/8	0.40	0.75	1.62	1.10	4.02	1"	0.16	0.16	1-11/16
YA292N						1/2	0.56	0.75	1.62	1.11	5.21	1-3/4"	0.16	0.16	
YA292TC58E16						5/8	0.69	0.75	1.62	1.11	5.27	1-3/4"	0.16	0.16	
YA302TC38	300 kcmil	—	150	White	17 or 298	3/8	0.40	0.81	2.00	1.20	4.45	1"	0.16	0.16	2-1/16
YA302N						1/2	0.56	0.81	2.00	1.20	5.64	1-3/4"	0.16	0.16	
YA312TC14E2	350 kcmil	—	185	Red	18 or 324	1/4	0.27	0.88	2.00	1.29	4.05	3/4"	0.18	0.18	2-1/16
YA312TC38						3/8	0.40	0.88	2.00	1.29	4.49	1"	0.18	0.18	
YA312N						1/2	0.56	0.88	2.00	1.29	5.69	1-3/4"	0.18	0.18	
YA322TC38	400 kcmil	—	—	Blue	19 or 470	3/8	0.40	0.95	2.12	1.40	4.66	1"	0.19	0.19	2-3/16
YA322N						1/2	0.56	0.95	2.12	1.40	5.85	1-3/4"	0.19	0.19	
YA332N	450 kcmil	—	—	Gray	326 or 538	1/2	0.56	1.01	2.13	1.48	5.93	1-3/4"	0.21	0.21	2-3/16

*** The MM² conductor sizes listed are the recommendations for Class 2 conductor

◆ For applications greater than 2000 volts consult cable manufacturer for voltage stress relief instructions

Available undrilled. Add suffix U to catalog number (example: YA25U)

Notes: All dimensions shown are for reference only.

Field bending straight lugs to achieve an angular connection will void UL Listing / CSA Certifications and BURNDY will not be liable for the connection.

TYPES YA-2N, YA-2TC, YA-4N (Continued)

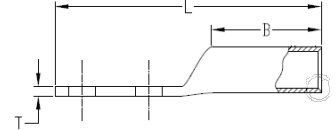
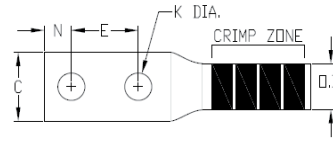

▲ See Copper Code Long Barrel Terminal Tooling Tables in this section for complete tool and die listing information.

Catalog Number	Conductor			Color Code	Die Index	Stud Size	Figure Dimensions								Wire Strip Length
	Code	Flex	Metric MM ² ***				Stud Hole Diameter (K)	Outside Diameter (OD)	Barrel Length (B)	Pad Width (C)	Overall Length (L)	Hole Spacing (E) & (F)	Hole Offset (N)	Pad Thickness (T)	
YA342TC14E2	500 kcmil	—	240	Brown	20 or 299	1/4	0.27	1.06	2.25	1.55	4.46	3/4"	0.23	0.23	2-5/16
YA342TC38						3/8	0.40	1.06	2.25	1.55	4.90	1"	0.23	0.23	
YA342N						1/2	0.56	1.06	2.25	1.55	6.06	1-3/4"	0.23	0.23	
YA352N	550 kcmil	—	—	Yellow	21	1/2	0.56	1.13	2.63	1.65	6.49	1-3/4"	0.25	0.25	2-11/16
YA362TC38	600 kcmil	—	300	Green	22 or 472	3/8	0.40	1.19	2.69	1.74	5.59	1"	0.26	0.26	2-3/4
YA362N						1/2	0.56	1.19	2.69	1.74	6.59	1-3/4"	0.27	0.27	
YA372N	650 kcmil	—	—	Orange	23	1/2	0.56	1.23	2.81	1.80	6.74	1-3/4"	0.63	0.27	2-7/8
YA382TC38	700 kcmil	—	—	Pink	400	3/8	0.40	1.25	2.81	1.84	5.76	1"	0.50	0.27	2-7/8
YA382N						1/2	0.56	1.25	2.81	1.84	6.77	1-3/4"	0.63	0.27	
YA392NT38	750 kcmil	—	—	Black	24	3/8	0.40	1.30	2.88	1.91	5.87	1"	0.50	0.27	2-15/16
YA392TC38						3/8	0.40	1.30	2.88	1.63	5.87	1"	0.50	0.27	
YA392N						1/2	0.40	1.30	2.88	1.91	6.87	1-3/4"	0.63	0.27	
YA392ENNT						1/2	0.56	1.30	2.88	1.30	6.87	1-3/4"	0.63	0.27	
YA402N	800 kcmil	—	400	Orange	25	1/2	0.56	1.35	2.94	1.98	6.95	1-3/4"	0.63	0.30	3
YA412N	850 kcmil	—	—	Gold	26	1/2	0.56	1.38	2.94	2.01	6.96	1-3/4"	0.63	0.31	3
YA442TC38	1000 kcmil	—	500	White	27	3/8	0.40	1.50	3.00	2.19	6.14	1"	0.63	0.33	3-1/16
YA442N				White	27	1/2	0.56	1.50	3.00	2.19	7.14	1-3/4"	0.63	0.32	3-1/16
YA452N	1250 kcmil	—	—	Yellow	29	1/2	0.56	1.69	3.19	2.46	7.44	1-3/4"	0.63	0.38	3-1/4
YA4532N	1300 kcmil	—	—	Orange	30	1/2	0.56	1.74	3.19	2.53	7.48	1-3/4"	0.63	0.39	3-1/4
YA462N	1500 kcmil	—	—	Green	31	1/2	0.56	1.84	3.19	2.69	7.55	1-3/4"	0.63	0.40	3-1/4
YA472N	1750 kcmil	—	—	Gray	33	1/2	0.56	1.98	3.44	2.90	7.89	1-3/4"	0.63	0.42	3-1/2
YA482N	2000 kcmil	—	1000	Brown	34	1/2	0.56	2.13	3.44	3.10	7.98	1-3/4"	0.63	0.46	3-1/2

*** The MM² conductor sizes listed are the recommendations for Class 2 conductor

◆ For applications greater than 2000 volts consult cable manufacturer for voltage stress relief instructions

Available undrilled. Add suffix U to catalog number (example: YA25U)

Notes: All dimensions shown are for reference only.

Field bending straight lugs to achieve an angular connection will void UL Listing / CSA Certifications and BURNDY will not be liable for the connection.

Compression Connections

Copper Compression — Terminal — Code — Two Hole
Narrow Tongue, Long Barrel — No Inspection Window

TYPE YA-2NT

HYLUG™

Uninsulated Copper Compression Terminal
UL Listed 90° C, Up to 35 kV ♦

45° and 90° angles available. Please contact Customer Service to order:
1-800-346-4175

Features & Benefits

- No inspection window is ideal for more corrosive environments as the barrel transition is not open
- Narrow tongue/tang is designed for limited space applications
- Barrel is designed with an internal chamfer at the wire entry to ensure smooth insertion of the wire, preventing possible damaging of the strands
- Long barrel allows for an increased number of crimps which will increase the mechanical strength of the connection
- Two hole tongue/tang is recommended when space permits as the 2-hole feature minimizes the terminations from loosening or rotating under vibration, movement, or heat cycling
- 45° and 90° angular lugs are available; please contact Customer Service
- Electro-tin plated unless otherwise specified to reduce galvanic corrosion (bimetallic) and resist corrosive elements
- Connectors are clearly marked with stamping and barrel color coding
- BURNDY certifies its products using the BURNDY Engineered System and select other crimp tool manufacturers in accordance with one or more of the UL categories in order to obtain a UL Listing
- Terminals and splices accommodating code wire: Accommodates Code Class B (Concentric, Compressed, Compact) and Class C wire

Accessories

- Hardware - Section F
- PENETROX™ Oxide Inhibitor - Section F
- Heat and Cold Shrink Tubing - Section D
- WIREMIKE™ Wire Micrometer - Section F
- Wire Management (Cable Ties) - Section G

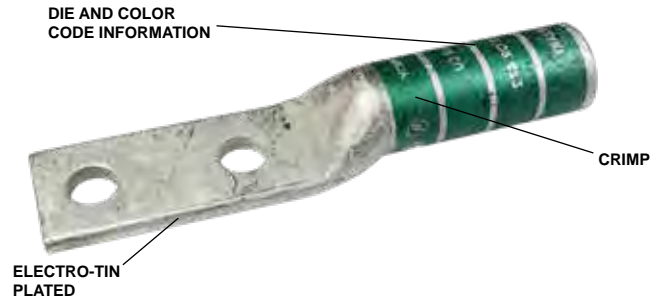

NOTE: Field bending straight lugs to achieve an angular connection will void UL Listing / CSA Certifications and BURNDY will not be liable for the connection.

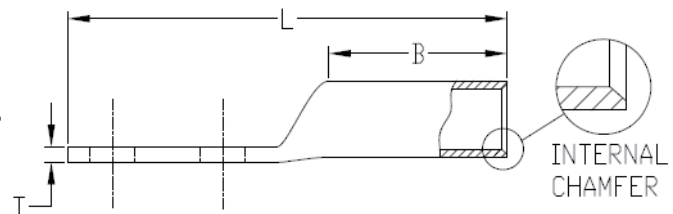
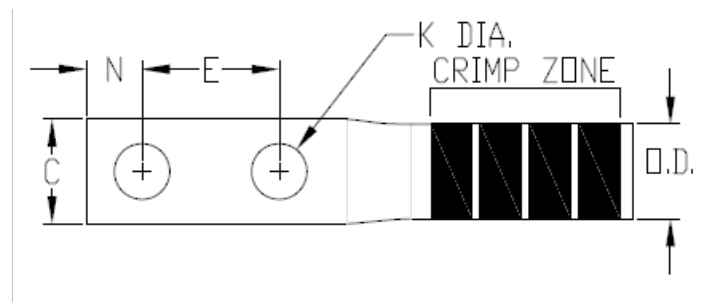

TYPE YA-2NT (Continued)

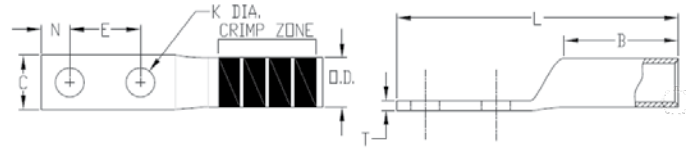

▲ See Copper Code Long Barrel Terminal Tooling Tables in this section for complete tool and die listing information.

Catalog Number	Conductor			Color Code	Die Index	Stud Size	Figure Dimensions								Wire Strip Length
	Code	Flex	Metric MM ² ***				Stud Hole Diameter (K)	Outside Diameter (OD)	Barrel Length (B)	Pad Width (C)	Overall Length (L)	Hole Spacing (E) & (F)	Hole Offset (N)	Pad Thickness (T)	
YA8C2NT8	8 AWG	#8 G,H,I,K,M DLO	10	Red	49	#8	0.18	0.27	0.81"	0.33"	2.14"	5/8"	0.22	0.09"	7/8"
YA6C2NT8	6 AWG 6 Sol	—	—	Blue	7 or 374	#8	0.18	0.29	0.81"	0.33"	2.14"	5/8"	0.22	0.09"	1-3/16"
YA4C2NT10	4 AWG	—	—	Black	8 or 346	#10	0.21	0.34	1.12"	0.33"	2.47"	5/8"	0.25	0.09"	1-3/16"
YA4C2NT14						1/4"	0.27	0.4	1.12"	0.49"	2.70"	5/8"	0.31	0.09"	
YA2C2NT14	2 AWG	—	35	Brown	10	1/4"	0.27	0.42	1.25"	0.48"	2.86"	5/8"	0.31	0.11"	1-5/16"
YA2C2NT14E2						1/4"	0.27	0.42	1.25"	0.75"	2.99"	3/4"	0.31	0.11"	
YA2C2NT14E1						1/4"	0.27	0.42	1.00"	0.60"	3.26"	1"	0.31	0.13"	
YA1C2NT10	1 AWG	—	50	Green	11 or 375	#10	0.21	0.46	1.38"	0.50"	2.90"	5/8"	0.25	0.10"	1-7/16"
YA1C2NT14						1/4"	0.27	0.46	1.38"	0.50"	3.03"	5/8"	0.31	0.10"	
YA1C2NT14E2						1/4"	0.27	0.46	1.38"	0.75"	3.15"	3/4"	0.31	0.10"	
YA1C2TC38						3/8"	0.40	0.46	1.38"	0.60"	3.59"	1"	0.41	0.10"	
YA1C2N						1/2"	0.56	0.46	1.38"	0.83"	4.82"	1-3/4"	0.63	0.12"	
YA252NT14	1/0 AWG	—	—	Pink	12	1/4"	0.27	0.52	1.38"	0.48"	3.05"	5/8"	0.31	0.09"	1-7/16"
YA252NT14E1						1/4"	0.27	0.52	1.38"	0.48"	3.05"	1"	0.31	0.09"	
YA252NT38						3/8"	0.41	0.52	1.38"	0.48"	3.05"	1"	0.41	0.09"	
YA262NT14	2/0 AWG	—	70	Black	13	1/4"	0.27	0.56	1.50"	0.48"	3.22"	5/8"	0.31	0.12"	1-9/16"
YA262NT14E1						1/4"	0.27	0.56	1.50"	0.48"	3.59"	1"	0.31	0.12"	
YA262NT516						5/16"	0.33	0.56	1.50"	0.52"	3.66"	1"	0.34	0.13"	
YA262NT38						3/8"	0.41	0.56	1.50"	0.62"	3.78"	1"	0.41	0.13"	
YA272NT14	3/0 AWG	—	—	Orange	14	1/4"	0.27	0.62	1.50"	0.60"	3.26"	5/8"	0.31	0.13"	1-9/16"
YA272NT516						5/16"	0.33	0.62	1.50"	0.60"	3.70"	1"	0.34	0.13"	
YA272NT38						3/8"	0.41	0.62	1.50"	0.76"	3.82"	1"	0.41	0.13"	
YA282NT14	4/0 AWG	—	—	Purple	15	1/4"	0.27	0.69	1.62"	0.76"	3.42"	5/8"	0.31	0.14"	1-11/16"
YA282NT516						5/16"	0.33	0.69	1.62"	0.76"	3.86"	1"	0.34	0.14"	
YA282NT38						3/8"	0.41	0.69	1.62"	0.76"	3.99"	1"	0.41	0.10"	
YA292NT14	250 kcmil	—	—	Yellow	16	1/4"	0.27	0.75	1.62"	0.76"	3.49"	5/8"	0.31	0.16"	1-11/16"
YA292NT516						5/16"	0.33	0.75	1.62"	0.76"	3.90"	1"	0.34	0.16"	
YA292NT38						3/8"	0.41	0.75	1.62"	0.76"	4.02"	1"	0.41	0.16"	
YA292NT38E16						3/8"	0.41	0.75	1.62"	0.76"	4.77"	1-3/4"	0.41	0.16"	
YA292NNT						1/2"	0.56	0.75	1.62"	0.96"	5.21"	1-3/4"	0.63	0.16"	

*** The MM² conductor sizes listed are the recommendations for Class 2 conductor

◆ For applications greater than 2000 volts consult cable manufacturer for voltage stress relief instructions

Notes: All dimensions shown are for reference only.

Field bending straight lugs to achieve an angular connection will void UL Listing / CSA Certifications and BURNDY will not be liable for the connection.

Compression Connections

Copper Compression — Terminal — Code — Two Hole
Narrow Tongue, Long Barrel — No Inspection Window

TYPE YA-2NT (Continued)

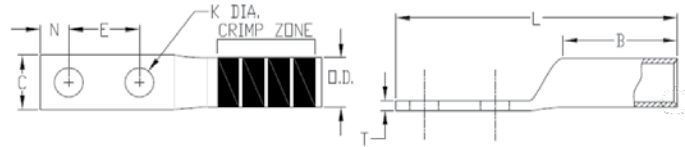

▲ See Copper Code Long Barrel Terminal Tooling Tables in this section for complete tool and die listing information.

Catalog Number	Conductor			Color Code	Die Index	Stud Size	Figure Dimensions								Wire Strip Length
	Code	Flex	Metric MM ² ***				Stud Hole Diameter (K)	Outside Diameter (OD)	Barrel Length (B)	Pad Width (C)	Overall Length (L)	Hole Spacing (E) & (F)	Hole Offset (N)	Pad Thickness (T)	
YA302NT38	300 kcmil	—	150	White	17 or 298	3/8"	0.41	0.81	2.00"	0.52"	3.66"	1"	0.41	0.13"	2-1/16"
YA312NT38	350 kcmil	—	185	Red	18 or 324	3/8"	0.41	0.88	2.00"	0.96"	4.48"	1"	0.41	0.18"	2-1/16"
YA312NT38E16						3/8"	0.41	0.88	2.00"	0.96"	5.24"	1-3/4"	0.41	0.18"	
YA322NT38	400 kcmil	—	—	Blue	19 or 470	3/8"	0.41	0.95	2.12"	0.96"	4.66"	1"	0.41	0.19"	2-3/16"
YA322NNT						1/2"	0.56	0.95	2.00"	0.96"	5.24"	1-3/4"	0.62	0.18"	
YA342NT38	500 kcmil	—	240	Brown	20 or 299	3/8"	0.41	1.06	2.25"	0.96"	4.90"	1"	0.41	0.23"	2-5/16"
YA342NT38E16						3/8"	0.41	1.06	2.25"	0.96"	4.90"	1-3/4"	0.41	0.23"	
YA342NNT						1/2"	0.56	1.06	2.25"	0.76"	6.08"	1-3/4"	0.63	0.23"	
YA342NT58						5/8"	0.69	1.06	2.25"	1.29"	6.15	1-3/4"	0.66	0.23"	
YA362NT38	600 kcmil	—	300	Green	22 or 472	3/8"	0.41	1.19	2.69"	1.12"	6.59"	1-3/4"	0.63	0.26"	2-3/4"
YA362NNT						1/2"	0.56	1.19	2.69"	1.47"	6.59"	1-3/4"	0.63	0.27"	
YA362NT12						1/2"	0.56	1.19	2.69"	1.12"	6.59"	1-3/4"	0.63	0.26"	
YA392NT38	750 kcmil	—	—	Black	24	3/8"	0.41	1.30	2.88"	1.12"	5.87"	1"	0.50	0.16"	2-15/16"
YA392NT38E16						3/8"	0.41	1.30	2.88"	1.12"	6.43"	1-3/4"	0.41	0.16"	
YA392NNT						1/2"	0.56	1.30	2.88"	1.63"	6.87"	1-3/4"	0.63	0.26"	
YA392ENNT						1/2"	0.56	1.30	2.88"	1.30"	6.87"	1-3/4"	0.63	0.26"	
YA392NT58						5/8"	0.69	1.30	2.88"	1.30"	6.93"	1-3/4"	0.66	0.26"	

*** The MM² conductor sizes listed are the recommendations for Class 2 conductor

◆ For applications greater than 2000 volts consult cable manufacturer for voltage stress relief instructions

Notes: All dimensions shown are for reference only.

Field bending straight lugs to achieve an angular connection will void UL Listing / CSA Certifications and BURNDY will not be liable for the connection.

TYPE YAZ-2TC-SL

HYLUG™

Uninsulated Copper Compression Terminal
UL Listed 90° C, Up to 35 kV ♦

Compression slotted lugs connect copper or tinned copper conductors to bus bars, CPI racks, cabinets or cable runway. Slotted and 90° slotted lugs have one round and one oblong hole to match hole spacing on equipment mounting rails on CPI racks and cabinets and on some bus bars.

Features & Benefits

- Inspection window allows for visual verification that the wire has been fully inserted prior to crimping the lug
- Barrel is designed with an internal chamfer at the wire entry to ensure smooth insertion of the wire, preventing possible damaging of the wire strands during installation
- Long barrel allows for an increased number of crimps which will increase the mechanical strengths of the connection
- One hole with slotted second hole tongue/tang offers additional flexibility over a standard 2-hole tongue/tang as the slot provides the installer with multiple mounting hole alignments options. The 2-hole feature minimizes the terminations from loosening or rotating under vibration, movement or heat cycling
- 45° and 90° angular lugs are available; please contact Customer Service
- Electro-tin plated unless specified to reduce galvanic corrosion (bimetallic) and resist corrosive elements
- Connectors are clearly marked with stamping and barrel color coding
- BURNDY certifies its products using the BURNDY Engineered System and select other crimp tool manufacturers in accordance with one or more of the UL categories in order to obtain a UL Listing
- Terminals and splices accommodating code wire: Accommodates Code Class B (Concentric, Compressed, Compact) and Class C wire



NOTE: Field bending straight lugs to achieve an angular connection will void UL Listing / CSA Certifications and BURNDY will not be liable for the connection.

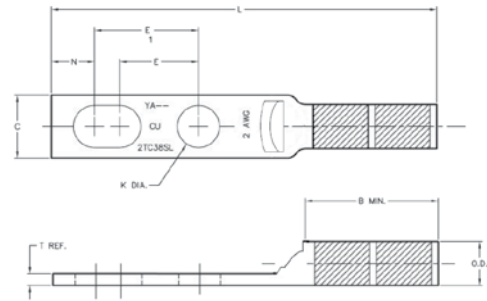

Fig. 1

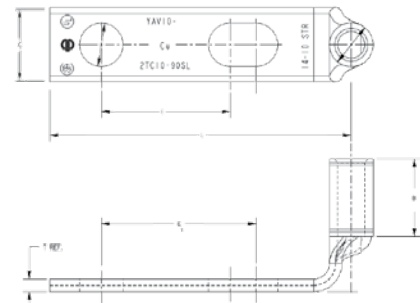

Fig. 2

Catalog Number	Wire Size	Stud Hole Size	Fig.	Tongue Width	Figure Dimensions					Installation Tooling (# of crimps)					Wire Strip Length	
					(B)	(T)	(L)	(E)	(E1)	Dieless	MD6, OUR840, MD734R	500 Series	35, 750, 46** Series	Color Code		Die Index
YAZ8C2TC10SL	8 AWG	#10	1	0.41	0.75	0.08	2.21	0.62	0.75	MY29 Series (1)	W8CRT (2) W8CVT (2) X8CRT (2)	W8CRT (2)	U8CRT (2)	Red	49	13/16
YAZ8C2TC1090SL		#10		0.41	0.75	0.08	1.50	0.62	0.75							
YAZ3C2TC38SL	3 AWG	3/8	2	0.58	1.25	0.08	3.39	0.75	1	MY29 Series (1) 644 Series (1) 444 Series (1)	W3CRT (2)	W3CRT (2)	U3CRT (2)	White	9	1-5/16
YAZ3C2TC38SLBOX500		3/8		0.58	1.25	0.08	3.43	0.75	1							
YAZ2C2TC38SL	2 AWG	3/8	2	0.60	1.25	0.11	3.41	0.75	1	MY29 Series (1) 644 Series (1) 444 Series (1)	W2CRT (2) W2CVT (2)	W2CRT (2) W2CVT (2)	U2CRT (2)	Brown	10	1-5/16
YAZ2C2TC38SLBOX500		3/8		0.60	1.25	0.11	3.42	0.75	1							

* Denotes 90° Angle

** Use PUADP1 adapter with U dies in 46 Series of tools

Note: All dimensions shown are for reference only.

TYPE YA-2TC-SL

HYLUG™

Uninsulated Copper Compression Terminal
UL Listed 90° C, Up to 35 kV ♦

Compression slotted lugs connect copper or tinned copper conductors to bus bars, CPI racks, cabinets or cable runway. Slotted and 90° slotted lugs have one round and one oblong hole to match hole spacing on equipment mounting rails on CPI racks and cabinets and on some bus bars.



NOTE: Field bending straight lugs to achieve an angular connection will void UL Listing / CSA Certifications and BURNDY will not be liable for the connection.

Features & Benefits

- Inspection window allows for visual verification that the wire has been fully inserted prior to crimping the lug
- Barrel is designed with an internal chamfer at the wire entry to ensure smooth insertion of the wire, preventing possible damaging of the wire strands during installation
- Long barrel allows for an increased number of crimps which will increase the mechanical strength of the connection
- One hole with slotted second hole tongue/tang offers additional flexibility over a standard 2-hole tongue/tang as the slot provides the installer with multiple mounting hole alignments options. The 2-hole feature minimizes the terminations from loosening or rotating under vibration, movement or heat cycling
- 45° and 90° angular lugs are available; please contact Customer Service
- Electro-tin plated unless specified to reduce galvanic corrosion (bimetallic) and resist corrosive elements
- Connectors are clearly marked with stamping and barrel color coding
- BURNDY certifies its products using the BURNDY Engineered System and select other crimp tool manufacturers in accordance with one or more of the UL categories in order to obtain a UL Listing
- Terminals and splices accommodating code wire: Accommodates Code Class B (Concentric, Compressed, Compact) and Class C wire

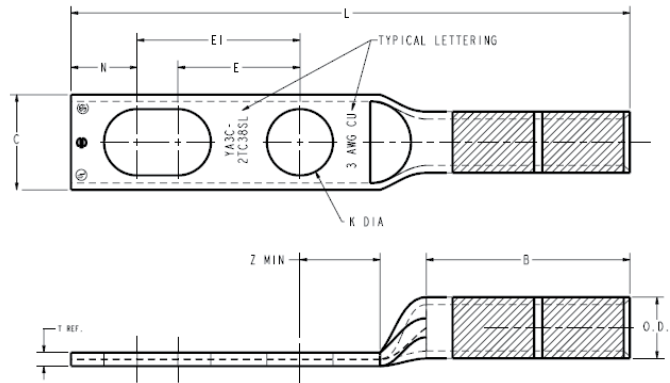

Accessories

- Hardware - Section F
- PENETROX™ Oxide Inhibitor - Section F
- Heat and Cold Shrink Tubing - Section D
- WIREMIKE™ Wire Micrometer - Section F
- Wire Management (Cable Ties) - Section G

Catalog Number	Wire Size	Stud Hole Size	Tongue Width	Figure Dimensions					Installation Tooling (# of crimps)					Wire Strip Length	
				(B)	(T)	(L)	(E)	(E1)	Dieless	MD6, OUR840, MD734R	500 Series	35, 750, 46* Series	Color Code		Die Index
YA6C2TC38SL	6 AWG	3/8	0.58	1.12	0.06	3.22	0.75	1	MY29 Series (1)	W5CRT (2) W5CVT (2)	W5CRT (2) W5CVT (2)	U8CABT (2)	Blue	7374	1-3/16
YA6C2TC38SLBOX500		3/8	0.58	1.12	0.06	3.22	0.75	1							
YA3C2TC38SL	3 AWG	3/8	0.58	1.25	0.08	3.43	0.75	1	MY29 Series (1) 644 Series (1) 444 Series (1) 81K Series (1)	W3CRT (2)	W3CRT (2)	U3CRT (2)	White	9	1-5/16
YA3C2TC38SLBOX500		3/8	0.58	1.25	0.08	3.43	0.75	1							
YA2C2TC38SL	2 AWG	3/8	0.60	1.25	0.11	3.42	0.75	1	MY29 Series (1) 644 Series (1) 444 Series (1)	W2CRT (2) W2CVT (2)	W2CRT (2) W2CVT (2)	U2CRT (2)	Brown	10	1-5/16
YA2C2TC38SLBOX500		3/8	0.60	1.25	0.11	3.42	0.75	1							

Note: All dimensions shown are for reference only.

*Use PUADP1 adapter with U dies in 46 Series of tools

TYPES YA-4N, YAB-4N

HYLUG™



Uninsulated Copper Compression Terminal
UL Listed 90° C, Up to 35 kV ◆

45° and 90° angles available. Please contact Customer Service to order: 1-800-346-4175

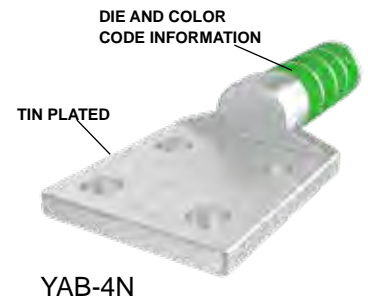
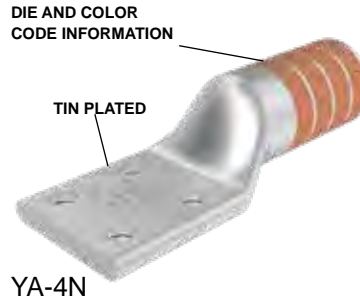

Features & Benefits

- No inspection window is ideal for more corrosive environments as the barrel transition is not open
- Barrel is designed with an internal chamfer at the wire entry to ensure smooth insertion of the wire, preventing possible damaging of the strands
- Long barrel allows for an increased number of crimps which will increase the mechanical strength of the connection
- Four hole tongue/tang is recommended when space permits as the 4-hole feature minimizes the terminations from loosening or rotating under vibration, movement, or heat cycling
- 45° and 90° angular lugs are available; please contact Customer Service
- Electro-tin plated unless otherwise specified to reduce galvanic corrosion (bimetallic) and resist corrosive elements
- Connectors are clearly marked with stamping and barrel color coding
- BURNDY certifies its products using the BURNDY Engineered System and select other crimp tool manufacturers in accordance with one or more of the UL categories in order to obtain a UL Listing
- Terminals and splices accommodating code wire: Accommodates Code Class B (Concentric, Compressed, Compact) and Class C wire

▲ See Copper Code Long Barrel Terminal Tooling Tables in this section for complete tool and die listing information.

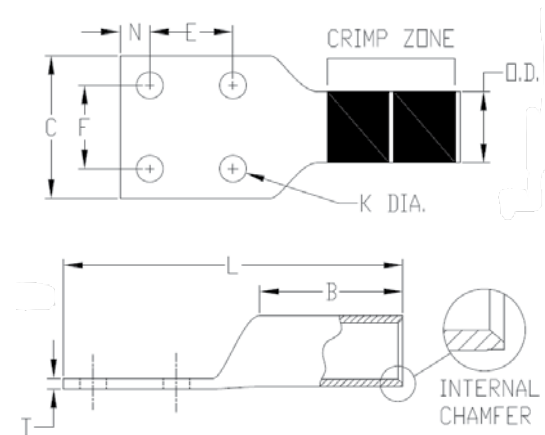

Accessories

- Hardware - Section F
- PENETROX™ Oxide Inhibitor - Section F
- Heat and Cold Shrink Tubing - Section D
- WIREMIKE™ Wire Micrometer - Section F
- Wire Management (Cable Ties) - Section G

Catalog Number	Conductor			Color Code	Die Index	Stud Size	Figure Dimensions								Wire Strip Length
	Code	Flex	Metric MM² ***				Stud Hole Diameter (K)	Outside Diameter (OD)	Barrel Length (B)	Pad Width (C)	Overall Length (L)	Hole Spacing (E) & (F)	Hole Offset (N)	Pad Thickness (T)	
YAB344N	500 kcmil	—	—	Brown	20	1/2	0.56	1.06	2.25	3.00	6.33	1.75	0.62	0.25	2-5/16
YAB364N	600 kcmil	—	—	Green	22	1/2	0.56	1.19	2.69	3.00	6.79	1.75	0.62	0.25	2-3/4
YAB394N	750 kcmil	—	—	Black	24	1/2	0.56	1.30	2.88	3.00	7.15	1.75	0.62	0.25	2-15/16
YA444N	1000 kcmil	—	500	White	27	1/2	0.56	1.50	3.00	3.00	7.14	1.75	0.63	0.23	3-1/16
YA454N	1250 kcmil	—	—	Yellow	29	1/2	0.56	1.69	3.19	3.00	7.44	1.75	0.63	0.30	3-1/4
YA464N	1500 kcmil	—	—	Green	31	1/2	0.56	1.84	3.19	3.00	7.55	1.75	0.63	0.34	3-1/4
YA474N	1750 kcmil	—	—	Gray	33	1/2	0.56	1.98	3.44	2.90	7.89	1.75	0.63	0.39	3-1/2
YA484N	2000 kcmil	—	1000	Brown	34	1/2	0.56	2.13	3.44	3.10	7.98	1.75	0.63	0.46	3-1/2
YA4864N	2500 kcmil	—	—	—	—	1/2	0.56	2.38	4.69	3.46	9.38	1.75	0.63	0.52	4-3/4

*** The MM² conductor sizes listed are for Class 2 conductor. For applications greater than 2000 Volts, consult cable manufacturer for voltage stress relief instructions

** Not UL Listed

Available undrilled. Add suffix U to catalog number (example YA444NU)

Note: All dimensions shown are for reference only

Field bending straight lugs to achieve an angular connection will void UL Listing / CSA Certifications and BURNDY will not be liable for the connection.

Compression Connections

Copper Compression — Terminal — Code
Split Tongue, Long Barrel — with Inspection Window

TYPES YAZ-4TC

HYLUG™

Uninsulated Copper Compression Terminal
UL Listed 90° C, Up to 35 kV ♦

Features & Benefits

- Inspection window allows for visual verification that the wire has been fully inserted prior to crimping the lug
- Split feature in the tongue/tang is used when connecting two separate terminal blocks for the same phase; the slot provides the needed equipment gap while allowing the proper mounting hole alignment
- Barrel is designed with an internal chamfer at the wire entry to ensure smooth insertion of the wire, preventing possible damaging of the wire strands during installation
- Long barrel allows for an increased number of crimps which will increase the mechanical strengths of the connection
- Two hole tongue/tang is recommended when space permits as the 2-hole feature minimizes the terminations from loosening or rotating under vibration, movement or heat cycling
- 45° and 90° angular lugs are available; please contact Customer Service
- Electro-tin plated unless specified to reduce galvanic corrosion (bimetallic) and resist corrosive elements
- Connectors are clearly marked with stamping and barrel color coding
- BURNDY certifies its products using the BURNDY Engineered System and select other crimp tool manufacturers in accordance with one or more of the UL categories in order to obtain a UL Listing
- Terminals and splices accommodating code wire: Accommodates Code Class B (Concentric, Compressed, Compact) and Class C wire



NOTE: Field bending straight lugs to achieve an angular connection will void UL Listing / CSA Certifications and BURNDY will not be liable for the connection.

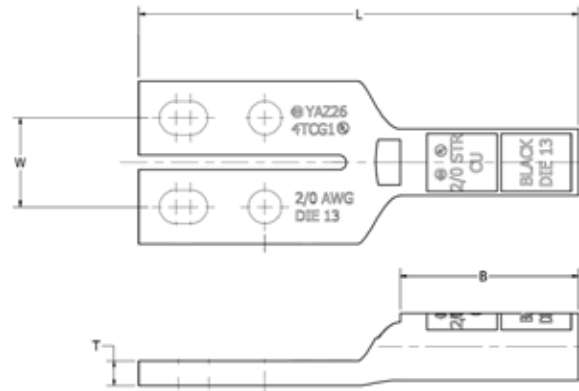

Accessories

- Hardware - Section F
- PENETROX™ Oxide Inhibitor - Section F
- Heat and Cold Shrink Tubing - Section D
- WIREMIKE™ Wire Micrometer - Section F
- Wire Management (Cable Ties) - Section G

Catalog Number	Wire Size	Stud Hole Size	Stud Hole Spacing	Tongue Width	Figure Dimensions			Installation Tooling					Wire Strip Length	
					(B)	(T)	(L)	Dieless (# of crimps)	MD6, OUR840, MD734R	500 Series	35, 750, 46** Series	Color Code		Die Index
YAZ254TCG1	1/0 AWG	1/4	0.62	1.38	1.38	0.11	3.55	MY29 Series (1) 644 Series (1) 444 Series (1)	X25RT (1)	X25RT (1)	U25RT (2)	Pink	12 or 348	1-7/16
YAZ254TC38E1G1		3/8	1.00	1.63	1.38	0.11	3.93		W25RT (1)	W25RT (1)	U2CABT (2)			
YAZ264TC38E1G1	3/8	1.00	1.63	1.50	0.21	4.09	W25VT (1)		W25VT (1)					
YAZ264TCG1	2/0 AWG	1/4	0.62	1.38	1.50	0.21	3.71		X26RT (2)	X26RT (2)	U26RT (2)	Black	13	1-9/16
		3/8	1.00	1.63	1.50	0.21	3.71		W26RT (2)	W26RT (2)	U26D1 (2)			
YAZ284TCG1	4/0 AWG	1/4	0.62	1.38	1.62	0.21	3.91		X28RT (3)	X28RT (3)	U28RT (1)	Purple	15	1-11/16
YAZ294TCG1	250 kcmil	1/4	0.62	1.38	1.62	0.21	3.94		X29RT (4)	X29RT (4)	U29RT (2)	Yellow	16	1-11/16
							W29RT (2)		W29RT (2)	U29D1 (2)				
YAZ314TCG1	350 kcmil	1/4	0.62	1.38	2.00	0.21	4.39		W31RT (2)	W31RT (2)	U31D1 (2)	Red	18 or 324	2-1/16
							W31VT (2)		W31VT (2)	U29ART (2)				

** Use PUADP1 adapter with U dies in 46 Series of tools

TYPES YA-2NU, YA-4NU

Blank Tongue HYLUG™



Uninsulated Copper Compression Terminal
UL Listed 90° C, Up to 35 kV ♦

The Blank Tongue line of copper code HYLUG™ terminals are designed to provide maximum field flexibility. Scored lines prevent the drill from walking when trying to drill in this area. This innovative design allows the installer to customize the tongue drilling to fit their specific application while maintaining UL Listing and CSA Certification.

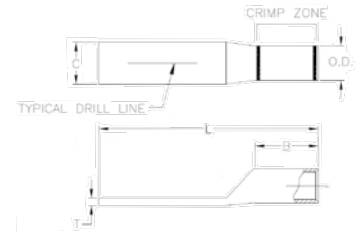

Features & Benefits

- Manufactured from seamless high conductivity electrolytic copper tubing with heavy duty wall thickness
- Internally beveled barrel end
- Proper compression systems form a highly efficient electrical connection
- Dimples located at each end of the scored line represent the location of the NEMA standard hole spacing
- Scored line locates the center of the tongue and prevents the drill from walking when trying to drill in this area
- Offered a wide range of code conductor sizes
- BURNDY certifies its products using the BURNDY Engineered System and select other crimp tool manufacturers in accordance with one or more of the UL categories in order to obtain a UL Listing
- Terminals and splices accommodating code wire: Accommodates Code Class B (Concentric, Compressed, Compact) and Class C wire

Catalog Number	Conductor		Min. Bolt Hole**	Tongue Width	Figure Dimensions			Installation Tooling (# of crimps)					Wire Strip Length	
	AWG	*** MM ²			B	T	L	Dieless	MD6, OUR840, MD734R	500 Series	35, 750, 46* Series	Color Code		Die Index
YA8C2NU	8 AWG 6 Sol 8 Sol 8 Weld 37/24	—	#10	0.83	0.81	0.12	4.08	Y1MRTC (2) Y122CMR (2) MY29 Series (1)	W8CRT (1) W8CVT (1) X8CRT (2)	W8CRT (1)	U8CRT (1) U8CRT (1)	Red	49	7/8
YA6C2NU	6 AWG 6 Sol.	—	#10	0.83	1.12	0.12	4.40	Y1MRTC (2) Y122CMR (2) MY29 Series (1) MRC840 (2) 81K Series (1)	W5CVT (2) W5CRT (2) X5CRT (2) X8CART (2)	W5CVT (2) W5CRT (2) X5CRT (2) X8CART (2)	U5CRT (2) U8CABT (2)	Blue	7 or 374	1-3/16
YA5C2NU	5 AWG	16	—	0.83	1.12	0.12	4.43	MY29 Series (2) MRC840 (2) 81K Series (1)	W5CRT (2) W5CVT (2) X5CRT (2)	X5CRT (2) X5CVT (2) W5CRT (2)	U5CRT (2)	Blue	7	1-3/16
YA4C2NU	4 AWG	—	#10	0.83	1.12	0.12	4.45	Y1MRTC (4) Y122CMR (4) MY29 Series (2) MRC840 (2)	W4CVT (2) W4CRT (2) X4CRT (2)	W4CVT (2) W4CRT (2) X4CRT (2)	U4CRT (2) U6CABT (2)	Gray	8 or 346	1-3/16
YA3C2NU	3 AWG 2 Sol.	25	1/4	0.83	1.25	0.12	4.62	644 Series (1) 444 Series (1) 81K Series (1)	W3CRT (2)	W3CRT (2)	U3CRT (2)	White	9	1-5/16
YA2C2NU	2 AWG	35	1/4	0.83	1.25	0.12	4.64	Y122CMR (4) Y1MRTC (4) MY29 Series (2) MRC840 (2)	W2CVT (2) W2CRT (2) X2CRT (2)	W2CVT (2) W2CRT (2) X2CRT (2)	U2CRT (2)	Brown	10	1-5/16
YA1C2NU	1 AWG	50	1/4	0.83	1.38	0.12	4.82	644 Series (1) 444 Series (1) 81K Series (2)	W1CVT (2) W1CRT1 (2) X1CRT1 (2)	W1CVT (2) W1CRT1 (2) X1CRT1 (2)	U1CRT1 (2) U4CABT (2)	Green	11	1-7/16

* Use PUADP1 adaptor with U dies in 46 Series

** Minimum bolt hole size must be maintained for UL & CSA

*** The MM² conductor sizes listed are the recommendations for Class 2 conductor

† Requires Y60BHU HYPRESS™

NOTE: Field bending straight lugs to achieve an angular connection will void UL Listing / CSA Certifications and BURNDY will not be liable for the connection.

Compression Connections

Copper Compression — Terminal — Code — Blank Tongue
Long Barrel — No Inspection Window

TYPES YA-2NU, YA-4NU (Continued)



NOTE: Field bending straight lugs to achieve an angular connection will void UL Listing / CSA Certifications and BURNDY will not be liable for the connection.



Catalog Number	Conductor		Min. Bolt Hole**	Tongue Width	Figure Dimensions			Installation Tooling (# of crimps)					Wire Strip Length	
	AWG	*** MM ²			B	T	L	Dieless	MD6, OUR840, MD734R	500 Series	35, 750, 46" Series	Color Code		Die Index
YA252NU	1/0 AWG	—	1/4	0.83	1.38	0.11	4.81	MY29 Series (2) MRC840 (4) 644 Series (1) 444 Series (1) 81K Series (2)	W25VT (4) W25RT (4) X25RT (4)	W25VT (4) W25RT (4) X25RT (4)	U25RT (2) U2CABT (2)	Pink	12 or 348	1-7/16
YA262NU	2/0 AWG	70	1/4	0.83	1.50	0.12	4.97		W26VT (4) W26RT (4) X26RT (4)	W26VT (4) W26RT (4) X26RT (4)	U26RT (2)	Black	13	1-9/16
YA272NU	3/0 AWG	—	1/4	0.91	1.50	0.13	5.01		W27VT (4) W27RT (4) X27RT (6)	W27VT (4) W27RT (4) X27RT (6)	U27RT (2)	Orange	14	1-9/16
YA282NU	4/0 AWG	—	1/4	1.02	1.62	0.14	5.17		W28VT (4) W28RT (4) X28RT (6)	W28VT (4) W28RT (4) X28RT (6)	U28RT (2)	Purple	15	1-11/16
YA292NU	250 kcmil	120	1/4	1.11	1.62	0.16	5.21	MY29 Series (2) 644 Series (1) 444 Series (1) 81K Series (2)	W29VT (4) X29RT (8)	W29VT (4) W29RT (4) X29RT (8)	U29RT (2)	Yellow	16	1-11/16
YA302NU	300 kcmil	150	1/4	1.20	2.00	0.16	5.64	644 Series (1) 444 Series (1) 81K Series (3)	W30VT (4)	W30VT (4) W30RT (4)	U30RT (4) U28ART (4)	White	17	2-1/16
YA312NU	350 kcmil	185	1/4	1.29	2.00	0.18	5.68		W31VT (4)	W31VT (4) W31RT (4)	U31RT (4) U29ART (4)	Red	18	2-1/16
YA322NU	400 kcmil	—	3/8	1.40	2.12	0.19	5.85		W32VT (4)	W32VT (4) W32RT (4)	U32RT (4) U30ART (4)	Blue	19 or 470	2-3/16
YA342NU	500 kcmil	240	3/8	1.55	2.25	0.22	6.06	644 Series (1) 444 Series (1) 81K Series (4)	W34VT (4)	W34VT (4) W34RT (4)	U34RT (4) U31ART (4)	Brown	20 or 299	2-5/16
YA362NU	600 kcmil	300	3/8	1.73	2.69	0.26	6.59	—	—	U36RT (4) U32ART (4)	Green	22 or 472	2-3/4	
YA392NU	750 kcmil	375	3/8	1.91	2.88	0.27	6.87	644 Series (1) 444 Series (1) 81K Series (3)	—	—	U39RT (4) P39RT (4)	Black	24	2-15/16
YA402NU	800 kcmil	400	3/8	1.98	2.94	0.30	6.95		—	—	P40RT (4)	Orange	25	3
YA442NU	1000 kcmil	500	3/8	2.18	3.00	0.32	7.14		—	—	P44RT (4)	White	27	3-1/16

* Use PUADP1 adaptor with U dies in 46 Series

** Minimum bolt hole size must be maintained for UL & CSA

*** The MM² conductor sizes listed are the recommendations for Class 2 conductor

† Requires 60 Ton Series HYPRESS™

TYPES YA-2NU, YA-4NU (Continued)



NOTE: Field bending straight lugs to achieve an angular connection will void UL Listing / CSA Certifications and BURNDY will not be liable for the connection.



Catalog Number	Conductor		Min. Bolt Hole**	Tongue Width	Figure Dimensions			Installation Tooling (# of crimps)					Wire Strip Length	
	AWG	*** MM ²			B	T	L	Dieless	MD6, OUR840, MD734R	500 Series	35, 750, 46* Series	Color Code		Die Index
YA452NU	1250 kcmil	—	3/8	2.46	3.19	0.38	7.44	—	—	—	P45RT (6)	Yellow	29	3-1/4
YA462NU	1500 kcmil	800	3/8	2.69	3.19	0.40	7.55	—	—	—	P46RT (6)	Green	31	3-1/4
YA472NU	1750 kcmil	—	3/8	2.90	3.44	0.42	7.89	—	—	—	—	Gray	33	3-1/2
YA482NU	2000 kcmil	1000	3/8	3.10	3.44	0.46	7.98	—	—	—	—	Brown	34	3-1/2
YA444NU	1000 kcmil	500	3/8	3.00	3.00	0.23	7.14	—	—	—	P44RT	White	27	3-1/16
YA454NU	1250 kcmil	—	3/8	3.00	3.19	0.30	7.44	—	—	—	P45RT	Yellow	29	3-1/4
YA464NU	1500 kcmil	800	3/8	3.00	3.19	0.34	7.55	—	—	—	P46RT	Green	31	3-1/4

* Use PUADP1 adaptor with U dies in 46 Series

** Minimum bolt hole size must be maintained for UL & CSA

*** The MM² conductor sizes listed are the recommendations for Class 2 conductor

† Requires 60 Ton Series HYPRESS™

Compression Connections

Copper Code Long Barrel Terminal Tooling Table
Mechanical/Ratchet (Dedicated Die or Requiring Dies)

Catalog Number Type	Wire Size	Color Code and Die Index Number	Mechanical & Ratchet Dies Required (# Crimps)		Mechanical & Ratchet Dedicated Die Tools # Crimps				
	Conductor (CU Only)		MD6 and MD7 Series <small>*Due to handle force not recommended</small>	OUR840 <small>*Due to handle force not recommended</small>	MY28 and MY29 Series	MRC840	MRE1022B Y8MRB1 Y10D Y1022	Y122CMR	Y1MRTC
YA-10	#14 - #10 AWG #12 - #10 Sol B,C	—	—	—	—	—	2 CRIMPS	—	—
YA-8C-	#8 AWG B,C,G,H,I,K,M DLO #6 Sol / #8 Sol	RED 49	X8CRT (2) W8CRT (2) W8CVT (2)	X8CRT (2) W8CRT (2) W8CVT (2)	2 CRIMPS	2 CRIMPS	—	2 CRIMPS	2 CRIMPS
YA-6C-	#6 AWG Str / Sol B,C	BLUE 7	X5CRT (2) W5CRT (2) W5CVT (2)	X5CRT (2) W5CRT (2) W5CVT (2)	2 CRIMPS	2 CRIMPS	—	2 CRIMPS	2 CRIMPS
YA-5C-	#5 AWG B,C	BLUE 7	X5CRT (2) W5CRT (2) W5CVT (2)	X5CRT (2) W5CRT (2) W5CVT (2)	2 CRIMPS	2 CRIMPS	—	2 CRIMPS	2 CRIMPS
YA-4C-	#4 AWG B,C	GRAY 8	X4CRT (2) W4CRT (2) W4CVT (2)	X4CRT (2) W4CRT (2) W4CVT (2)	2 CRIMPS	2 CRIMPS	—	4 CRIMPS	4 CRIMPS
YA-3C-	#3 Str / #2 Sol B,C	WHITE 9	W3CRT (2)	W3CRT (2)	2 CRIMPS	2 CRIMPS	—	4 CRIMPS	4 CRIMPS
YA-2C-	#2 AWG B,C	BROWN 10	X2CRT (2) W2CRT (2) W2CVT (2)	X2CRT (2) W2CRT (2) W2CVT (2)	2 CRIMPS	2 CRIMPS	—	4 CRIMPS	4 CRIMPS
YA-1C-	#1 AWG B,C	GREEN 11	X1CRT1 (2) W1CRT1 (2) W1CVT (2)	X1CRT1 (2) W1CRT1 (2) W1CVT (2)	2 CRIMPS	2 CRIMPS	—	—	4 CRIMPS
YA-25-	1/0 AWG B,C	PINK 12	X25RT (4) W25RT (4) W25VT (4)	X25RT (4) W25RT (4)* W25VT (4)*	2 CRIMPS	4 CRIMPS	—	—	—
YA-26-	2/0 AWG B,C	BLACK 13	X26RT (4) W26RT (4) W26VT (4)	X26RT (4) W26RT (4)* W26VT (4)*	2 CRIMPS	4 CRIMPS	—	—	—
YA-27-	3/0 AWG B,C	ORANGE 14	X27RT (6) W27RT (4) W27VT (4)	X27RT (6) W27RT (4)* W27VT (4)*	2 CRIMPS	4 CRIMPS	—	—	—
YA-28-	4/0 AWG B,C	PURPLE 15	X28RT (6) W28RT (4) W28VT (4)	X28RT (6) W28RT (4)* W28VT (4)*	2 CRIMPS	4 CRIMPS	—	—	—
YA-29-	250 kcmil B,C	YELLOW 16	X29RT (8) W29RT (4) W29VT (4)	X29RT (8) W29RT (4)* W29VT (4)*	2 CRIMPS	—	—	—	—
YA-30-	300 kcmil B,C	WHITE 17	W30RT (4)* W30VT (4)	—	—	—	—	—	—
YA-31-	350 kcmil B,C	RED 18	W31RT (4)* W31VT (4)	—	—	—	—	—	—
YA-32-	400 kcmil B,C	BLUE 19	W32RT (4)* W32VT (4)	—	—	—	—	—	—
YA-33-	450 kcmil B,C	GRAY 326	W33RT (4)* W33VT (4)	—	—	—	—	—	—
YA-34-	500 kcmil B,C	BROWN 20	W34RT (4)* W34VT (4)	—	—	—	—	—	—

Catalog Number Type	Wire Size	Color Code and Die Index Number	Hydraulic Tools - Dies Required (# Crimps)					Hydraulic Tools - Dieless	
	Conductor (CU Only)		MD6, 600, 500 Series	750, 35 Series	45 Series <i>Use PT6515 with U Dies</i>	46 Series <i>Use PUADP1 with U Dies</i>	60 Series	81K 4PC Series	644 444 Series
YA-10	#14 - #10 AWG #12 - #10 Sol B,C	—	—	—	—	—	—	—	—
YA-8C-	#8 AWG B,C,G,H,I,K,M DLO #6 Sol / #8 Sol	RED 49	X8CRT (2) W8CRT (2) W8CVT (2)	U8CRT (2)	U8CRT (2)	U8CRT (2)	—	1 CRIMP	—
YA-6C-	#6 AWG Str / Sol B,C	BLUE 7	X5CRT (2) W5CRT (2) W5CVT (2)	U5CRT (2)	U5CRT (2)	U5CRT (2)	—	1 CRIMP	—
YA-5C-	#5 AWG B,C	BLUE 7	X5CRT (2) W5CRT (2) W5CVT (2)	U5CRT (2)	U5CRT (2)	U5CRT (2)	—	1 CRIMP	—
YA-4C-	#4 AWG B,C	GRAY 8	X4CRT (2) W4CRT (2) W4CVT (2)	U4CRT (2)	U4CRT (2)	U4CRT (2)	—	1 CRIMP	1 CRIMP
YA-3C-	#3 Str / #2 Sol B,C	WHITE 9	W3CRT (2)	U3CRT (2)	U3CRT (2)	U3CRT (2)	—	2 OVERLAPPING CRIMPS	1 CRIMP
YA-2C-	#2 AWG B,C	BROWN 10	X2CRT (2) W2CRT (2) W2CVT (2)	U2CRT (2)	U2CRT (2)	U2CRT (2)	—	2 OVERLAPPING CRIMPS	1 CRIMP
YA-1C-	#1 AWG B,C	GREEN 11	X1CRT1 (2) W1CRT1 (2) W1CVT (2)	U1CRT1 (2)	U1CRT1 (2)	U1CRT1 (2)	—	2 OVERLAPPING CRIMPS	1 CRIMP
YA-25-	1/0 AWG B,C	PINK 12	X25RT (4) W25RT (4) W25VT (4)	U25RT (2)	U25RT (2)	U25RT (2)	—	2 OVERLAPPING CRIMPS	1 CRIMP
YA-26-	2/0 AWG B,C	BLACK 13	X26RT (4) W26RT (4) W26VT (4)	U26RT (2)	U26RT (2)	U26RT (2)	—	2 CRIMPS	1 CRIMP
YA-27-	3/0 AWG B,C	ORANGE 14	X27RT (6) W27RT (4) W27VT (4)	U27RT (2)	U27RT (2)	U27RT (2)	—	2 CRIMPS	1 CRIMP
YA-28-	4/0 AWG B,C	PURPLE 15	X28RT (6) W28RT (4) W28VT (4)	U28RT (2)	U28RT (2)	U28RT (2)	L28RT (1)	2 CRIMPS	1 CRIMP
YA-29-	250 kcmil B,C	YELLOW 16	X29RT (8) W29RT (4) W29VT (4)	U29RT (2)	U29RT (2)	U29RT (2)	L29RT (1)	2 CRIMPS	1 CRIMP
YA-30-	300 kcmil B,C	WHITE 17	W30RT (4)* W30VT (4)	U30RT (4)	U30RT (4)	U30RT (4)	L30RT (1)	3 OVERLAPPING CRIMPS	1 CRIMP
YA-31-	350 kcmil B,C	RED 18	W31RT (4)* W31VT (4)	U31RT (4)	U31RT (4)	U31RT (4)	L31RT (1)	3 OVERLAPPING CRIMPS	1 CRIMP

Compression Connections

Copper Code Long Barrel Terminal Tooling Table Hydraulic Requiring Dies and Dieless

Catalog Number Type	Wire Size	Color Code and Die Index Number	Hydraulic Tools - Dies Required (# Crimps)					Hydraulic Tools - Dieless	
	Conductor (CU Only)		MD6, 600, 500 Series	750, 35 Series	45 Series <i>Use PT6515 with U Dies</i>	46 Series <i>Use PUADP1 with U Dies</i>	60 Series	81K 4PC Series	644 444 Series
YA-32-	400 kcmil B,C	BLUE 19	W32RT (4)* W32VT (4)	U32RT (4)	U32RT (4)	U32RT (4)	L32RT (1)	3 OVERLAPPING CRIMPS	1 CRIMP
YA-33-	450 kcmil B,C	GRAY 326	W33RT (4)* W33VT (4)	U33RT (4)	U33RT (4)	U33RT (4)	L33RT (1)	4 OVERLAPPING CRIMPS	1 CRIMP
YA-34-	500 kcmil B,C	BROWN 20	W34RT (4)* W34VT (4)	U34RT (4)	U34RT (4)	U34RT (4)	L34RT (2)	4 OVERLAPPING CRIMPS	1 CRIMP
YA-35-	550 kcmil B,C	YELLOW 21	—	U35RT (4)	U35RT (4)	U35RT (4)	L35RT (2)	4 OVERLAPPING CRIMPS	1 CRIMP
YA-36-	600 kcmil B,C	GREEN 22	—	U36RT (4)	U36RT (4)	U36RT (4)	L36RT (2)	4 CRIMPS	1 CRIMP
YA-37-	650 kcmil B,C	ORANGE 23	—	U37RT (4)	U37RT (4)	U37RT (4)	L37RT (2)	4 CRIMPS	1 CRIMP
YA-38-	700 kcmil B,C	PINK 400	—	U38RT (4)	U38RT (4)	U38RT (4)	L38RT (2)	4 CRIMPS	1 CRIMP
YA-39-	750 kcmil B,C	BLACK 24	—	U39RT (4)	U39RT (4)	U39RT (4) P39RT (4)	L39RT (2)	4 CRIMPS	1 CRIMP
YA-40-	800 kcmil B,C	ORANGE 25	—	—	S40RT (4)	P40RT (4)	L40RT (2)	4 CRIMPS	1 CRIMP
YA-41-	850 kcmil B,C	GOLD 26	—	—	—	P41D with P44PR (2)	—	4 CRIMPS	1 CRIMP
YA-44-	1000 kcmil B,C	WHITE 27	—	—	S44RT (4)	P44RT (4)	L44RT (2)	4 CRIMPS	1 CRIMP
YA-45-	1250 kcmil B,C	YELLOW 29	—	—	S45RT (6)	P45RT (6)	L45RT (3)	—	—
YA-453-	1300 kcmil B,C	ORANGE 30	—	—	—	—	—	—	—
YA-46-	1500 kcmil B,C	GREEN 31	—	—	S46RT (6)	P46RT (6)	L46RT (3)	—	—
YA-47-	1750 kcmil B,C	GRAY 33	—	—	—	—	L47RT (3)	—	—
YA-48-	2000 kcmil B,C	BROWN 34	—	—	—	—	L48RT (4)	—	—

Installation Instructions

Installation instructions help the installer understand proper wire preparation, proper insertion requirements, crimp zone location, individual crimp location, crimp order and crimp direction, to ensure safe and reliable wire connections. UL Listing and CSA Certification are only valid when using the BURNDY® Engineered System and following BURNDY Installation Instructions.

Copper Code Long Barrel Terminal Installation Steps:

1. Select the appropriate connector based on:
Wire Material
Wire Construction
Wire Size
2. Strip the insulation to the appropriate wire strip length, based on the table's Wire Strip Length recommendation for the selected connector. Due to tolerances in the connector, wire strip length, and insulation stripping tools, this range may be 0" - 1/4". The exposed wire, also known as a "shiner", has no performance impact on the connection and there is no wire exposure requirement by BURNDY.
3. As a best practice, wire brush the bare conductor to remove any oxides. DO NOT wire brush tin-plated connectors.
4. Insert the conductor into the barrel for the full length. If the connector has an inspection window, the conductor end can easily be seen to verify full wire insertion.
5. Apply the proper number of crimps specified by the appropriate illustration.
6. *Some catalog numbers require overlapping crimps when using the 81K or 4PC Series of installation tools. Please refer to the overlapping crimp image that is applicable based on the number of crimps required. Overlap each consecutive crimp so that the completed installation of all overlapping crimps covers the entire crimp zone.
7. Once all crimps have been completed, the connection can be easily inspected for proper installation.

NOTE: Illustrations show black bands however this is just a representation of the crimp zones. See individual connector for actual crimp band color.

Example: YAZ282TC38

- Go to the YA-28- Catalog Number Designation for 4/0 AWG.
 - Confirm the Tool (750 Series for this example).
 - Confirm the Die Set Needed (U28RT for this example)
 - Confirm the Number of Crimps Necessary (2 for this example)
- For proper crimp placement refer to the image on this page corresponding to the number of crimps.



CATALOG NUMBER DESIGNATIONS					
YA-8C-	YA-6C-	YA-5C-	YA-4C-	YA-3C-*	YA-2C-*
YA-1C-*	YA-37-	YA-38-	YA-40-	YA-41-	YA-44-

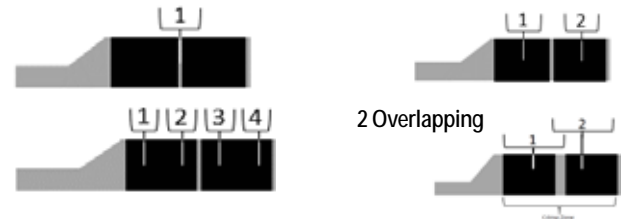

CATALOG NUMBER DESIGNATIONS			
YA-45-	YA-453-	YA-46-	YA-47-



CATALOG NUMBER DESIGNATIONS					
YA-25-*	YA-26-	YA-27-	YA-28-	YA-29-	YA-30-*
YA-31-*	YA-32-*	YA-33-*	YA-34-*	YA-35-*	YA-36-
YA-39-	YA-45-	YA-453-	YA-46-	YA-47-	YA-48-

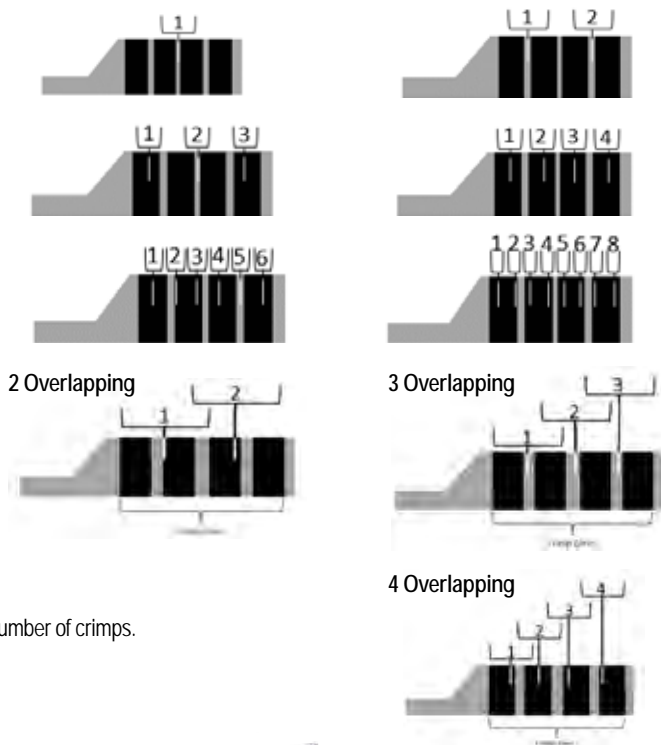

Copper Wire Table									
*Terminal Designation	Barrel O.D. (IN)	Code	Flexible Nominal Wire Size / Wire Classes / Wire Class Stranding					DLO	
		Class B, C	Flex Size (Nominal)	G	H	I	K		M
**YAV10	0.21	#14 - #10 AWG	#14 - #10 AWG	—	—	26/24	104/30	259/34	27/24
**YA8C	0.27	#8 AWG	#8 AWG	49	133	41/24	168/30	420/34	37/24
YAV6C	0.31	#6 AWG	#6 AWG	49	133	63/24	266/30	655/34	61/24
YA5C	0.30	#5 AWG	#5 AWG	49	133	84/24	336/30	836/34	91/24
YAV4C	0.38	#4 AWG	#4 AWG	49	133	105/24	420/30	1064/34	105/24
YAV3C	0.42	#3 AWG	#3 AWG	49	133	133/24	532/30	1323/34	125/24
YAV2C	0.46	#2 AWG	#2 AWG	49	133	161/24	665/30	1666/34	150/24
YAV1C	0.51	#1 AWG	#1 AWG	133	259	210/24	835/30	2107/34	225/24
YAV25-FX	0.56	1/0 AWG	1/0 AWG	133	259	226/24	1064/30	2646/34	275/24
YAV26-FX	0.63	2/0 AWG	2/0 AWG	133	259	342/24	1323/30	3325/34	325/24
YAV27-FX	0.70	3/0 AWG	3/0 AWG	133	259	418/24	1666/30	4256/34	450/24
YAV28-FX	0.77	4/0 AWG	4/0 AWG	133	427	532/24	2107/30	5320/34	550/24
YAV29	0.80	250 kcmil	4/0 AWG	(4/0 AWG) 133	(4/0 AWG) 427	(4/0 AWG) 532/24	(4/0 AWG) 2107/30	(4/0 AWG) 5320/34	(4/0 AWG) 550/24
YA30-FX	0.81	—	250 kcmil	259	427	—	—	—	—
YA31-FX	0.88	—	250 kcmil	—	—	637/24	2499/30	6348/34	262
YA32-FX	0.95	—	300 kcmil	259	427	735/24	2989/30	7581/34	313
YA34-FX	1.06	—	350 kcmil	259	427	882/24	3458/30	8806/34	373
YA36-FX	1.19	—	500 kcmil	259	427	—	—	—	444
YA38-FX	1.25	—	500 kcmil	—	427	1225/24	5054/30	—	535
		—	550 kcmil	427	703	1372/24	—	—	
YA39-FX	1.30	—	600 kcmil	427	703	1470/24	5985/30	—	1470/24
YA40-FX	1.35	—	650 kcmil	427	—	—	—	—	646
YA44-FX	1.50	—	750 kcmil	427	703	1862	—	—	777
YA46-FX	1.84	—	1000 kcmil	—	—	—	—	—	1111

*Catalog Number with suffix "FX" denote connectors that accommodate Copper Flexible Wire

TYPES YA-L, YA-L-FX, YAV, YAV-L-FX

HYLUG™

Uninsulated Copper Compression Terminal
UL Listed 90° C, Up to 35 kV ♦

45° and 90° angles available. Please contact Customer Service to order: 1-800-346-4175

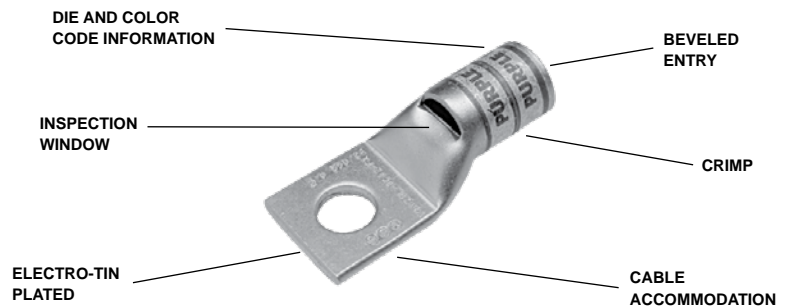

Features & Benefits

- Inspection windows allows for visual verification that the wire has been fully inserted prior to crimping the lug
- Barrel is designed with an internal chamfer at the wire entry to ensure smooth insertion of the wire, preventing possible damaging of the strands
- Short/Standard length barrel is recommended for installations with limited space requirements
- 45° and 90° angular lugs are available; please contact Customer Service
- Electro-tin plated unless otherwise specified to reduce galvanic corrosion (bimetallic) and resist corrosive elements
- Connectors are clearly marked with stamping and barrel color coding
- Connectors accommodating wire sizes #10 - 250 kcmil accommodate both Flex and Code Wire. See Tables on each page for specific details
- Tables in this section identify flex wire as the nominal flex wire size followed by the wire classes and DLO wire size and stranding. For Class Wire Strand counts, see the table at the beginning of this section.
- BURNDY certifies its products using the BURNDY Engineered System and select other crimp tool manufacturers in accordance with one or more of the UL categories in order to obtain a UL Listing



NOTE: Field bending straight lugs to achieve an angular connection will void UL Listing / CSA Certifications and BURNDY will not be liable for the connection.

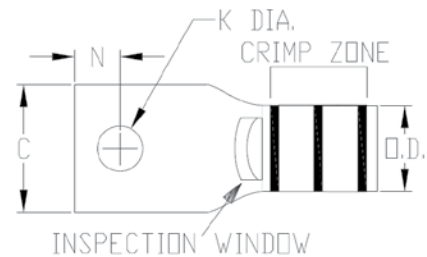

Accessories

- Hardware - Section F
- PENETROX™ Oxide Inhibitor - Section F
- Heat and Cold Shrink Tubing - Section D
- WIREMIKE™ Wire Micrometer - Section F
- Wire Management (Cable Ties) - Section G

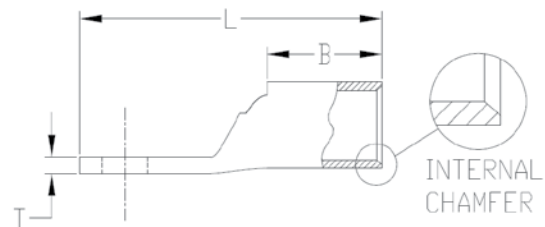

Compression Connections

Copper Compression — Terminal — Flex — One Hole
Standard Barrel — with Inspection Window

TYPES YA-L, YA-L-FX, YAV, YAV-L-FX (Continued)

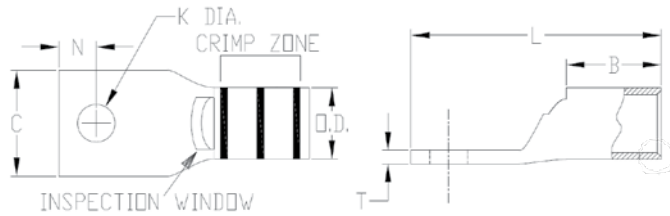

▲ See Copper Flex Standard Barrel Terminal Tooling Tables in this section for complete tool and die listing information.

Catalog Number	Conductor			Color Code	Die Index	Stud Size	Figure Dimensions							Wire Strip Length	
	Code	Flex	Metric MM ² ***				Stud Hole Diameter (K)	Outside Diameter (OD)	Barrel Length (B)	Pad Width (C)	Overall Length (L)	Hole Spacing (E) & (F)	Hole Offset (N)		Pad Thickness (T)
YA8CLBOX	#8 AWG #6 Sol #8 Sol	#8 AWG G,H,I,K,M, DLO	10	Red	49	#8 -#10	0.21	0.27	0.44	0.41	1.16	—	0.22	0.08	7/16
YA8CL1BOX						1/4	0.27	0.27	0.44	0.44	1.26	—	0.25	0.08	
YA8CL2BOX						5/16	0.33	0.27	0.44	0.52	1.38	—	0.34	0.06	
YA8CL3BOX						3/8	0.40	0.27	0.44	0.58	1.51	—	0.41	0.06	
YA8CL4BOX						1/2	0.53	0.27	0.44	0.71	1.76	—	0.53	0.05	
YAV6CLTC10FX	#6 AWG	#6 AWG G,H,I,K,M, DLO	16	Blue	7	#10	0.21	0.31	0.50	0.48	1.30	—	0.25	0.08	1/2
YAV6CLTC14FX						1/4	0.27	0.31	0.50	0.48	1.43	—	0.31	0.08	
YAV6CLTC516FX						5/16	0.33	0.31	0.50	0.52	1.49	—	0.34	0.07	
YAV6CLTC38FX						3/8	0.40	0.31	0.50	0.58	1.61	—	0.41	0.06	
YAV6CLTC12FX						1/2	0.53	0.31	0.50	0.75	1.86	—	0.53	0.12	
YAV6CLTC34FX						3/4	0.81	0.31	0.50	1.04	2.66	—	0.75	0.09	
YAV4CLTC10FX	#4 AWG	#4 AWG G,H,I,K,M, DLO	—	Gray	8	#10	0.21	0.38	0.50	0.55	1.32	—	0.25	0.09	1/2
YAV4CLTC14FX						1/4	0.27	0.38	0.50	0.55	1.44	—	0.31	0.09	
YAV4CLTC516FX						5/16	0.33	0.38	0.50	0.55	1.51	—	0.34	0.09	
YAV4CLTC38FX						3/8	0.40	0.38	0.50	0.58	1.67	—	0.41	0.08	
YAV4CLTC12FX						1/2	0.53	0.38	0.50	0.71	1.92	—	0.53	0.07	
YAV2CLTC10FX	#2 AWG	#2 AWG G,H,I,K,M, DLO	35	Brown	10	#10	0.21	0.46	0.63	0.68	1.50	—	0.25	0.10	11/16
YAV2CLTC14FX						1/4	0.27	0.46	0.63	0.68	1.62	—	0.31	0.10	
YAV2CLTC516FX						5/16	0.33	0.46	0.63	0.68	1.69	—	0.34	0.10	
YAV2CLTC38FX						3/8	0.40	0.46	0.63	0.68	1.81	—	0.41	0.10	
YAV2CLTC12FX						1/2	0.53	0.46	0.63	0.73	2.12	—	0.53	0.09	
YAV1CLTC10FX	#1 AWG	#1 AWG G,H,I,K,M, DLO	—	Green	11	#10	0.24	0.51	0.62	0.75	1.52	—	0.25	0.12	11/16
YAV1CLTC14FX						1/4	0.27	0.51	0.62	0.75	1.65	—	0.31	0.12	
YAV1CLTC516FX						5/16	0.33	0.51	0.62	0.75	1.71	—	0.34	0.12	
YAV1CLTC38FX						3/8	0.41	0.51	0.62	0.75	1.84	—	0.41	0.12	
YAV1CLTC12FX						1/2	0.53	0.51	0.62	0.75	2.09	—	0.53	0.12	
YAV25LTC14FX	1/0 AWG	1/0 AWG G,H,I,K,M, DLO	50	Pink	12	1/4	0.27	0.56	0.69	0.83	1.75	—	0.31	0.12	11/16
YAV25LTC516FX						5/16	0.33	0.56	0.69	0.83	1.81	—	0.34	0.12	
YAV25LTC38FX						3/8	0.40	0.56	0.69	0.83	1.94	—	0.41	0.12	
YAV25LTC12FX						1/2	0.53	0.56	0.69	0.83	2.19	—	0.53	0.12	

◆ For applications greater than 2000 volts consult cable manufacturer for voltage stress relief instructions

Notes: All dimensions shown are for reference only.

Field bending straight lugs to achieve an angular connection will void UL Listing / CSA Certifications and BURNDY will not be liable for the connection.

TYPES YA-L, YA-L-FX, YAV, YAV-L-FX (Continued)

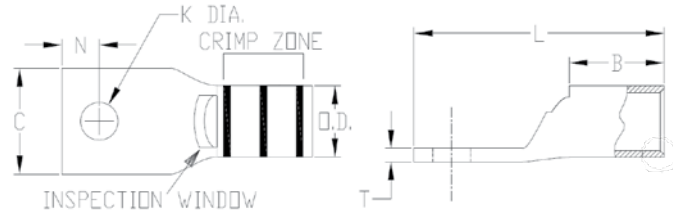

▲ See Copper Flex Standard Barrel Terminal Tooling Tables in this section for complete tool and die listing information.

Catalog Number	Conductor			Color Code	Die Index	Stud Size	Figure Dimensions								Wire Strip Length
	Code	Flex	Metric MM ² ***				Stud Hole Diameter (K)	Outside Diameter (OD)	Barrel Length (B)	Pad Width (C)	Overall Length (L)	Hole Spacing (E) & (F)	Hole Offset (N)	Pad Thickness (T)	
YAV26LTC10FX	2/0 AWG	G,H,I,K,M, DLO	70	Black	13	#10	0.21	0.63	0.81	0.93	1.80	—	0.25	0.13	13/16
YAV26LTC14FX						1/4	0.27	0.63	0.81	0.93	1.92	—	0.31	0.13	
YAV26LTC516FX						5/16	0.33	0.63	0.81	0.93	1.98	—	0.34	0.13	
YAV26LTC38FX						3/8	0.40	0.63	0.81	0.93	2.11	—	0.41	0.13	
YAV26LTC12FX						1/2	0.53	0.63	0.81	0.93	2.36	—	0.53	0.13	
YAV26LTC58FX						5/8	0.69	0.63	0.81	0.93	2.61	—	0.66	0.13	
YAV26LTC34FX						3/4	0.81	0.63	0.81	1.10	2.89	—	0.75	0.11	
YAV27LTC10FX	3/0 AWG	G,H,I,K,M, DLO	95	Orange	14	#10	0.21	0.70	1.00	1.03	2.03	—	0.25	0.14	1
YAV27LTC14FX						1/4	0.27	0.70	1.00	1.03	2.15	—	0.31	0.14	
YAV27LTC516FX						5/16	0.33	0.70	1.00	1.03	2.21	—	0.34	0.14	
YAV27LTC38FX						3/8	0.40	0.70	1.00	1.03	2.34	—	0.41	0.14	
YAV27LTC12FX						1/2	0.53	0.70	1.00	1.03	2.59	—	0.53	0.14	
YAV28LTC14FX	4/0 AWG	G,H,I,K,M, DLO	120	Purple	15	1/4	0.27	0.77	1.03	1.14	2.23	—	0.31	0.15	1-1/16
YAV28LTC516FX						5/16	0.33	0.77	1.03	1.14	2.29	—	0.34	0.15	
YAV28LTC38FX						3/8	0.41	0.77	1.03	1.14	2.42	—	0.41	0.15	
YAV28LTC12FX						1/2	0.53	0.77	1.03	1.14	2.67	—	0.53	0.15	
YAV28LTC58FX						5/8	0.69	0.77	1.03	1.14	2.92	—	0.66	0.15	
YAV28LTC34FX						3/4	0.81	0.77	1.03	1.14	3.11	—	0.75	0.15	
YAV29LTC14FX	250 kcmil	G,H,I,K,M, DLO	—	Yellow	16	1/4	0.27	0.80	1.03	1.18	2.23	—	0.31	0.16	1-1/16
YAV29LTC516FX						5/16	0.33	0.80	1.03	1.18	2.30	—	0.34	0.16	
YAV29LTC38FX						3/8	0.40	0.80	1.03	1.18	2.42	—	0.41	0.16	
YAV29LTC12FX						1/2	0.53	0.80	1.03	1.18	2.67	—	0.53	0.16	
YAV29LTC58FX						5/8	0.69	0.80	1.03	1.18	2.92	—	0.66	0.16	
YAV29LTC34FX						3/4	0.81	0.80	1.03	1.18	3.11	—	0.75	0.16	
YA30LTC516FX	—	250 kcmil G,H	—	Yellow	16	5/16	0.33	0.81	1.03	1.20	2.31	—	0.34	0.16	1-1/8
YA30LTC38FX						3/8	0.40	0.81	1.03	1.20	2.44	—	0.41	0.16	
YA30LTC12FX						1/2	0.53	0.81	1.03	1.20	2.69	—	0.53	0.16	
YA30LTC58FX						5/8	0.69	0.81	1.03	1.20	2.94	—	0.66	0.16	
YA30LTC34FX						3/4	0.81	0.81	1.03	1.20	3.12	—	0.75	0.16	

♦ For applications greater than 2000 volts consult cable manufacturer for voltage stress relief instructions

Notes: All dimensions shown are for reference only.

Field bending straight lugs to achieve an angular connection will void UL Listing / CSA Certifications and BURNDY will not be liable for the connection.

Compression Connections

Copper Compression — Terminal — Flex — One Hole
Standard Barrel — with Inspection Window

TYPES YA-L, YA-L-FX, YAV, YAV-L-FX (Continued)

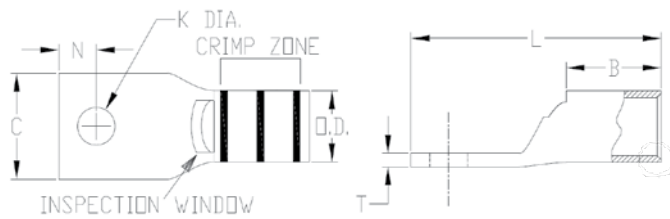

▲ See Copper Flex Standard Barrel Terminal Tooling Tables in this section for complete tool and die listing information.

Catalog Number	Conductor			Color Code	Die Index	Stud Size	Figure Dimensions								Wire Strip Length
	Code	Flex	Metric MM ² ***				Stud Hole Diameter (K)	Outside Diameter (OD)	Barrel Length (B)	Pad Width (C)	Overall Length (L)	Hole Spacing (E) & (F)	Hole Offset (N)	Pad Thickness (T)	
YA31LTC14FX	—	250 kcmil I,K,M, 262 DLO	150	White	17 or 298	1/4	0.27	0.88	1.06	1.29	2.31	—	0.31	0.18	1-1/8
YA31LTC516FX						5/16	0.33	0.88	1.06	1.29	2.37	—	0.34	0.18	
YA31LTC38FX						3/8	0.40	0.88	1.06	1.29	2.50	—	0.41	0.18	
YA31LTC12FX						1/2	0.53	0.88	1.06	1.29	2.75	—	0.53	0.18	
YA31LNT12FX						1/2	0.53	0.88	1.06	0.96	2.75	—	0.53	0.18	
YA31LTC58FX						5/8	0.69	0.88	1.06	1.29	3.00	—	0.66	0.18	
YA31LTC34FX						3/4	0.81	0.88	1.06	1.29	3.19	—	0.75	0.18	
YA32LTC38FX	—	300 kcmil G,H,I,K,M, 313 DLO	185	Red	18 or 324	3/8	0.41	0.95	1.19	1.40	2.68	—	0.41	0.19	1-1/4
YA32LTC12FX						1/2	0.53	0.95	1.19	1.40	2.93	—	0.53	0.19	
YA32LTC58FX						5/8	0.69	0.95	1.19	1.40	3.18	—	0.66	0.19	
YA32LTC100FX						1	1.06	0.95	1.19	1.74	3.87	—	1.00	0.27	
YA34LTC516FX	—	350 kcmil G,H,I,K,M, 373 DLO	240	Blue	19 or 470	5/16	0.33	1.06	1.27	1.55	2.74	—	0.34	0.23	1-5/16
YA34LTC38FX						3/8	0.40	1.06	1.27	1.55	2.87	—	0.41	0.23	
YA34LTC12FX						1/2	0.53	1.06	1.27	1.55	3.12	—	0.53	0.23	
YA34LTC58FX						5/8	0.69	1.06	1.27	1.55	3.37	—	0.66	0.23	
YA36LTC12FX	—	500 kcmil G,H 444 DLO	—	Brown	20 or 299	1/2	0.53	1.19	1.38	1.74	3.29	—	0.53	0.27	1-3/8
YA36LTC58FX						5/8	0.69	1.19	1.38	1.74	3.54	—	0.66	0.27	
YA38LTC516FX	—	500 kcmil H,I,K 550 kcmil G,H,I 535 DLO	300	Pink	L99	5/16	0.33	1.25	1.45	1.84	3.03	—	0.34	0.27	1-7/16
YA38LTC38FX						3/8	0.40	1.25	1.45	1.84	3.34	—	0.50	0.27	
YA38LTC12FX						1/2	0.53	1.25	1.45	1.84	3.41	—	0.53	0.27	
YA38LTC58FX						5/8	0.69	1.25	1.45	1.84	3.66	—	0.66	0.27	
YA40LTC516FX	—	650 kcmil G, 646 DLO	400	Black	24	5/16	0.33	1.35	1.42	1.98	3.05	—	0.34	0.30	1-5/16
YA40LTC38FX						3/8	0.40	1.35	1.42	1.98	3.38	—	0.50	0.30	
YA40LTC12FX						1/2	0.53	1.35	1.42	1.98	3.43	—	0.53	0.30	
YA40LTC58FX						5/8	0.69	1.35	1.42	1.98	3.68	—	0.66	0.30	
YA44LTC12FX	—	750 kcmil G,H,I 777 DLO	500	Yellow	L115	1/2	0.53	1.50	1.65	2.19	3.79	—	0.53	0.33	1-5/8
YA44LTC58FX						5/8	0.69	1.50	1.65	2.19	4.04	—	0.66	0.33	

◆ For applications greater than 2000 volts consult cable manufacturer for voltage stress relief instructions

Notes: All dimensions shown are for reference only.

Field bending straight lugs to achieve an angular connection will void UL Listing / CSA Certifications and BURNDY will not be liable for the connection.

TYPE YAG-L-TC

HYLUG™

Uninsulated Copper Compression Terminal
UL Listed 90° C, Up to 35 kV ◆

45° and 90° angles available. Please contact Customer Service to order:
1-800-346-4175

Features & Benefits

- No inspection window is ideal for more corrosive environments as the barrel transition is not open
- Barrel is designed with an internal chamfer at the wire entry to ensure smooth insertion of the wire, preventing possible damaging of the strands
- Short/Standard length barrel is recommended for installations with limited space requirements
- 45° and 90° angular lugs are available; please contact Customer Service
- Electro-tin plated unless otherwise specified to reduce galvanic corrosion (bimetallic) and resist corrosive elements
- Connectors are clearly marked with stamping and barrel color coding
- Connectors accommodating wire sizes #10 - 250 kcmil accommodate both Flex and Code Wire. See Tables on each page for specific details
- Tables in this section identify flex wire as the nominal flex wire size followed by the wire classes and DLO wire size and stranding. For Class Wire Strand counts, see the table at the beginning of this section.
- BURNDY certifies its products using the BURNDY Engineered System and select other crimp tool manufacturers in accordance with one or more of the UL categories in order to obtain a UL Listing

Accessories

- Hardware - Section F
- PENETROX™ Oxide Inhibitor - Section F
- Heat and Cold Shrink Tubing - Section D
- WIREMIKE™ Wire Micrometer - Section F
- Wire Management (Cable Ties) - Section G

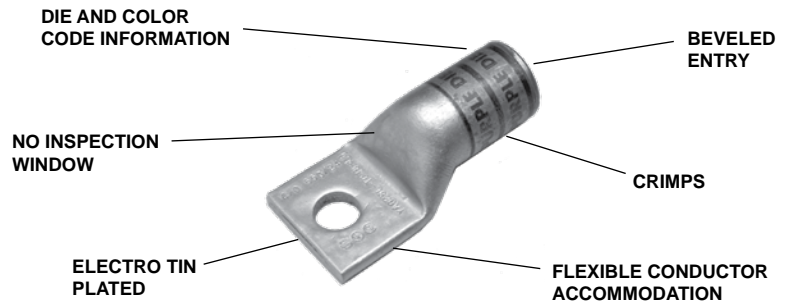

NOTE: Field bending straight lugs to achieve an angular connection will void UL Listing / CSA Certifications and BURNDY will not be liable for the connection.

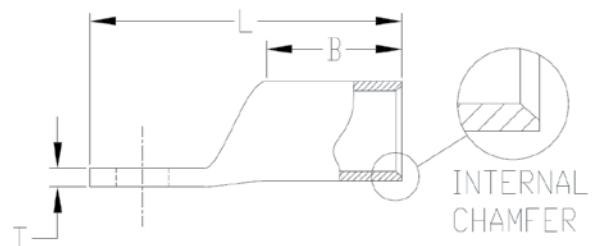
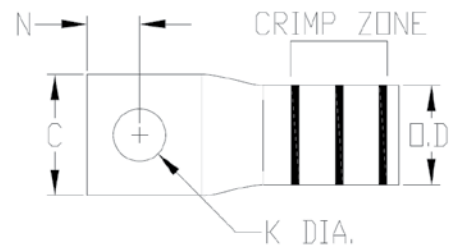

Compression Connections

Copper Compression — Terminal — Flex — One Hole
Standard Barrel — No Inspection Window

TYPE YAG-L-TC (Continued)

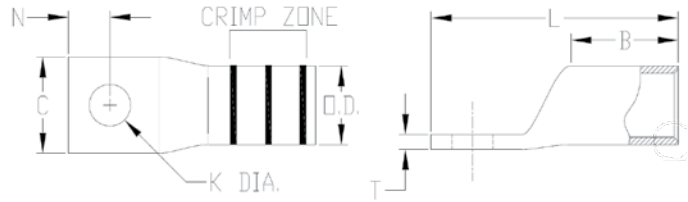

▲ See Copper Flex Standard Barrel Terminal Tooling Tables in this section for complete tool and die listing information.

Catalog Number	Conductor			Color Code	Die Index	Stud Size	Figure Dimensions								Wire Strip Length
	Code	Flex	Metric MM ² ***				Stud Hole Diameter (K)	Outside Diameter (OD)	Barrel Length (B)	Pad Width (C)	Overall Length (L)	Hole Spacing (E) & (F)	Hole Offset (N)	Pad Thickness (T)	
YAG8CLTC14FX	#8 AWG #6 Sol #8 Sol	#8 AWG G,H,I,K,M DLO	10	Red	49	1/4	0.27	0.27	0.44	0.44	1.32	—	0.31	0.08	1/2
YAG8CLTC516FX						5/16	0.33	0.27	0.44	0.52	1.38	—	0.34	0.06	
YAG8CLTC12FX						1/2	0.53	0.27	0.44	0.71	1.76	—	0.53	0.05	
YAG6CLTC14FX	#6 AWG	#6 AWG G,H,I,K,M, DLO	16	Blue	7	1/4	0.27	0.31	0.50	0.48	1.43	—	0.31	0.08	1/2
YAG6CLTC516FX						5/16	0.33	0.31	0.50	0.52	1.49	—	0.34	0.07	
YAG6CLTC38FX						3/8	0.40	0.31	0.50	0.58	1.61	—	0.41	0.06	
YAG6CLTC12FX						1/2	0.53	0.31	0.50	0.75	1.86	—	0.53	0.12	
YAG4CLTC14FX	#4 AWG	#4 AWG G,H,I,K,M, DLO	—	Gray	8	1/4	0.27	0.38	0.50	0.55	1.48	—	0.31	0.09	1/2
YAG4CLTC516FX						5/16	0.33	0.38	0.50	0.55	1.55	—	0.34	0.09	
YAG4CLTC38FX						3/8	0.40	0.38	0.50	0.58	1.67	—	0.41	0.08	
YAG4CLTC12FX						1/2	0.53	0.38	0.50	0.71	1.92	—	0.53	0.07	
YAG2CLTC14FX	#2 AWG	#2 AWG G,H,I,K,M, DLO	35	Brown	10	1/4	0.27	0.46	0.63	0.68	1.64	—	0.31	0.10	11/16
YAG2CLTC516FX						5/16	0.33	0.46	0.63	0.68	1.70	—	0.34	0.10	
YAG2CLTC38FX						3/8	0.40	0.46	0.63	0.68	1.83	—	0.41	0.10	
YAG2CLTC12FX						1/2	0.53	0.46	0.63	0.73	2.12	—	0.53	0.09	
YAG1CLTC14FX	#1 AWG	#1 AWG G,H,I,K,M, DLO	—	Green	11	1/4	0.27	0.51	0.62	0.75	1.67	—	0.31	0.12	11/16
YAG1CLTC516FX						5/16	0.33	0.51	0.62	0.75	1.73	—	0.34	0.12	
YAG1CLTC38FX						3/8	0.41	0.51	0.62	0.75	1.86	—	0.41	0.12	
YAG1CLTC12FX						1/2	0.53	0.51	0.62	0.75	2.11	—	0.53	0.12	
YAG25LTC14FX	1/0 AWG	1/0 AWG G,H,I,K,M, DLO	50	Pink	12	1/4	0.27	0.56	0.69	0.83	1.77	—	0.31	0.12	11/16
YAG25LTC516FX						5/16	0.33	0.56	0.69	0.83	1.84	—	0.34	0.12	
YAG25LTC38FX						3/8	0.40	0.56	0.69	0.83	1.96	—	0.41	0.12	
YAG25LTC12FX						1/2	0.53	0.56	0.69	0.83	2.21	—	0.53	0.12	
YAG26LTC14FX	2/0 AWG	2/0 AWG G,H,I,K,M, DLO	70	Black	13	1/4	0.27	0.63	0.81	0.93	1.95	—	0.31	0.13	13/16
YAG26LTC516FX						5/16	0.33	0.63	0.81	0.93	2.01	—	0.34	0.13	
YAG26LTC38FX						3/8	0.40	0.63	0.81	0.93	2.13	—	0.41	0.13	
YAG26LTC12FX						1/2	0.53	0.63	0.81	0.93	2.38	—	0.53	0.13	
YAG27LTC14FX	3/0 AWG	3/0 AWG G,H,I,K,M, DLO	95	Orange	14	1/4	0.27	0.70	1.00	1.03	2.18	—	0.31	0.14	1
YAG27LTC516FX						5/16	0.33	0.70	1.00	1.03	2.24	—	0.34	0.14	
YAG27LTC38FX						3/8	0.40	0.70	1.00	1.03	2.37	—	0.41	0.14	
YAG27LTC12FX						1/2	0.53	0.70	1.00	1.03	2.62	—	0.53	0.14	

◆ For applications greater than 2000 volts consult cable manufacturer for voltage stress relief instructions

Notes: All dimensions shown are for reference only.

Field bending straight lugs to achieve an angular connection will void UL Listing / CSA Certifications and BURNDY will not be liable for the connection.

TYPE YAG-L-TC (Continued)

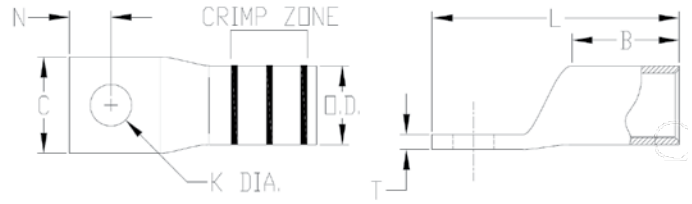

▲ See Copper Flex Standard Barrel Terminal Tooling Tables in this section for complete tool and die listing information.

Catalog Number	Conductor			Color Code	Die Index	Stud Size	Figure Dimensions								Wire Strip Length
	Code	Flex	Metric MM ² ***				Stud Hole Diameter (K)	Outside Diameter (OD)	Barrel Length (B)	Pad Width (C)	Overall Length (L)	Hole Spacing (E) & (F)	Hole Offset (N)	Pad Thickness (T)	
YAG28LTC14FX	4/0 AWG	4/0 AWG G,H,I,K,M, DLO	120	Purple	15	1/4	0.27	0.77	1.03	1.14	2.26	—	0.31	0.15	1-1/16
YAG28LTC516FX						5/16	0.33	0.77	1.03	1.14	2.32	—	0.34	0.15	
YAG28LTC38FX						3/8	0.40	0.77	1.03	1.14	2.45	—	0.41	0.15	
YAG28LTC12FX						1/2	0.53	0.77	1.03	1.14	2.70	—	0.53	0.15	
YAG29LTC38FX	250 kcmil	4/0 AWG G,H,I,K,M, DLO	—	Yellow	16	3/8	0.40	0.80	1.03	1.18	2.45	—	0.41	0.16	1-1/16
YAG29LTC12FX						1/2	0.53	0.80	1.03	1.18	2.70	—	0.53	0.16	
YAG29LTC58FX						5/8	0.69	0.80	1.03	1.18	2.95	—	0.66	0.16	
YAG30LTC38FX	—	250 kcmil G,H	—	Yellow	16	3/8	0.40	0.81	1.03	1.20	2.47	—	0.41	0.16	1-1/16
YAG30LTC12FX						1/2	0.53	0.81	1.03	1.20	2.72	—	0.53	0.16	
YAG30LTC58FX						5/8	0.69	0.81	1.03	1.20	2.97	—	0.66	0.16	
YAG31LTC14FX	—	250 kcmil I,K,M, 262 DLO	150	White	17	1/4	0.27	0.88	1.06	1.29	2.35	—	0.31	0.18	1-1/8
YAG31LTC516FX						5/16	0.33	0.88	1.06	1.29	2.41	—	0.34	0.18	
YAG31LTC38FX						3/8	0.40	0.88	1.06	1.29	2.53	—	0.41	0.18	
YAG31LTC12FX						1/2	0.53	0.88	1.06	1.29	2.78	—	0.53	0.18	
YAG31LTC58FX						5/8	0.69	0.88	1.06	1.29	3.03	—	0.66	0.18	
YAG32LTC12FX	—	300 kcmil G,H,I,K,M, 313 DLO	185	Red	18	1/2	0.53	0.95	1.19	1.40	2.97	—	0.53	0.19	1-1/4
YAG32LTC58FX						5/8	0.69	0.95	1.19	1.40	3.22	—	0.66	0.19	
YAG34LTC516FX	—	350 kcmil G,H,I,K,M, 373 DLO	240	Blue	19	5/16	0.33	1.06	1.27	1.55	2.78	—	0.34	0.23	1-5/16
YAG34LTC38FX						3/8	0.40	1.06	1.27	1.55	2.91	—	0.41	0.23	
YAG34LTC12FX						1/2	0.53	1.06	1.27	1.55	3.16	—	0.53	0.23	
YAG34LTC58FX						5/8	0.69	1.06	1.27	1.55	3.41	—	0.66	0.23	
YAG36LTC38FX	—	500 kcmil G,H 444 DLO	—	Brown	20	3/8	0.41	1.19	1.38	1.73	3.27	—	0.50	0.27	1-3/8
YAG38LTC516FX	—	500 kcmil H,I,K 550 kcmil G,H,I 535 DLO	300	Pink	L99	5/16	0.33	1.25	1.45	1.84	3.08	—	0.34	0.27	1-7/16
YAG38LTC38FX						3/8	0.40	1.25	1.45	1.84	3.39	—	0.50	0.27	
YAG38LTC12FX						1/2	0.53	1.25	1.45	1.84	3.46	—	0.53	0.27	
YAG40LTC516FX	—	650 kcmil G, 646 DLO	400	Black	24	5/16	0.33	1.35	1.42	1.96	3.11	—	0.34	0.30	1-5/16
YAG40LTC38FX						3/8	0.40	1.35	1.42	1.96	3.42	—	0.50	0.30	
YAG40LTC12FX						1/2	0.53	1.35	1.42	1.96	3.48	—	0.53	0.30	
YAG44LTC12FX	—	750 kcmil G,H, 777 DLO	500	Yellow	L115	1/2	0.53	1.50	1.65	2.18	3.85	—	0.53	0.33	1-5/8

♦ For applications greater than 2000 volts consult cable manufacturer for voltage stress relief instructions

Notes: All dimensions shown are for reference only.

Field bending straight lugs to achieve an angular connection will void UL Listing / CSA Certifications and BURNDY will not be liable for the connection.

Compression Connections

Copper Compression — Terminal — Flex — One Hole
Narrow Tongue, Standard Barrel — with Inspection Window

TYPE YAV-L-NTFX

HYLUG™

Uninsulated Copper Compression Terminal
UL Listed 90° C, Up to 35 kV ◆

45° and 90° angles available. Please contact Customer Service to order:
1-800-346-4175

Features & Benefits

- Inspection windows allows for visual verification that the wire has been fully inserted prior to crimping the lug
- Narrow tongue/tang is designed to allow for parallel terminations of wire in limited space applications
- Barrel is designed with an internal chamfer at the wire entry to ensure smooth insertion of the wire, preventing possible damaging of the strands
- Short/Standard length barrel is recommended for installations with limited space requirements
- 45° and 90° angular lugs are available; please contact Customer Service
- Electro-tin plated unless otherwise specified to reduce galvanic corrosion (bimetallic) and resist corrosive elements
- Connectors are clearly marked with stamping and barrel color coding
- Connectors accommodating wire sizes #10 - 250 kcmil accommodate both Flex and Code Wire. See Tables on each page for specific details
- Tables in this section identify flex wire as the nominal flex wire size followed by the wire classes and DLO wire size and stranding. For Class Wire Strand counts, see the table at the beginning of this section.
- BURNDY certifies its products using the BURNDY Engineered System and select other crimp tool manufacturers in accordance with one or more of the UL categories in order to obtain a UL Listing

Accessories

- Hardware - Section F
- PENETROX™ Oxide Inhibitor - Section F
- Heat and Cold Shrink Tubing - Section D
- WIREMIKE™ Wire Micrometer - Section F
- Wire Management (Cable Ties) - Section G

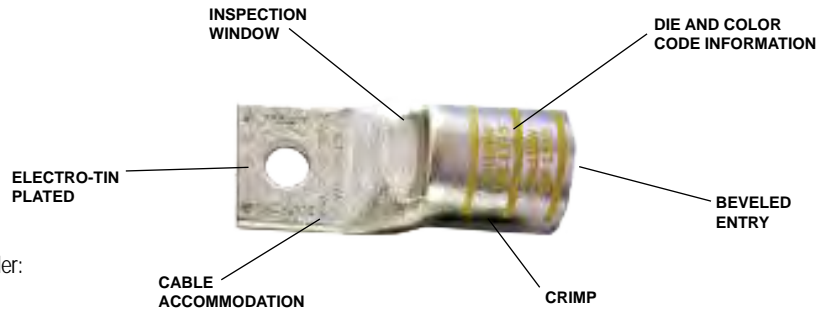

NOTE: Field bending straight lugs to achieve an angular connection will void UL Listing / CSA Certifications and BURNDY will not be liable for the connection.

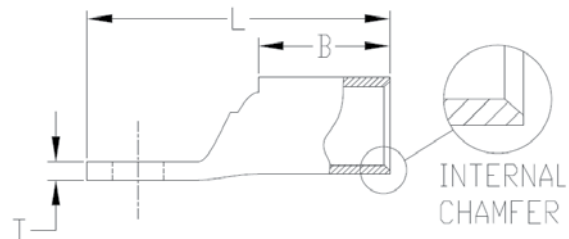
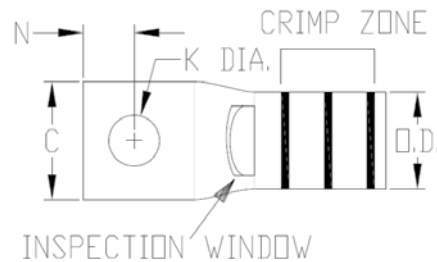

TYPEE YAV-L-NTFX (Continued)

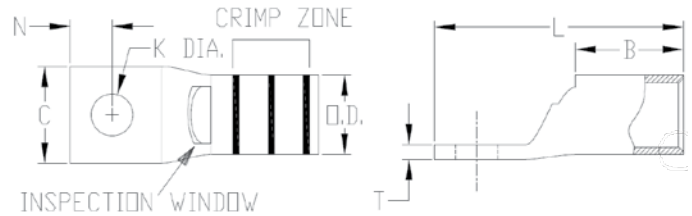

▲ See Copper Flex Standard Barrel Terminal Tooling Tables in this section for complete tool and die listing information.

Catalog Number	Conductor			Color Code	Die Index	Stud Size	Figure Dimensions								Wire Strip Length
	Code	Flex	Metric MM ² ***				Stud Hole Diameter (K)	Outside Diameter (OD)	Barrel Length (B)	Pad Width (C)	Overall Length (L)	Hole Spacing (E) & (F)	Hole Offset (N)	Pad Thickness (T)	
YAV4CLNT10FX	#4 AWG	#4 AWG G,H,I,K,M, DLO	—	Gray	8	#10	0.21	0.38	0.50	0.41	1.32	—	0.25	0.09	1/2
YAV2CLNT14FX	#2 AWG	#2 AWG G,H,I,K,M, DLO	35	Brown	10	1/4	0.27	0.46	0.63	0.46	1.71	—	0.31	0.10	11/16
YAV2CLNT516FX						5/16	0.33	0.46	0.63	0.44	1.78	—	0.34	0.10	
YAV25LNT14FX	1/0 AWG	1/0 AWG G,H,I,K,M, DLO	50	Pink	12	1/4	0.27	0.56	0.69	0.67	1.75	—	0.31	0.12	11/16
YAV25LNT516FX						5/16	0.33	0.56	0.69	0.67	1.81	—	0.34	0.12	
YAV25LNT38FX						3/8	0.40	0.56	0.69	0.76	1.94	—	0.41	0.13	
YAV26LNT516FX	2/0 AWG	2/0 AWG G,H,I,K,M, DLO	70	Black	13	5/16	0.33	0.63	0.81	0.90	1.98	—	0.34	0.13	13/16
YAV26LNT38FX						3/8	0.40	0.63	0.81	0.90	2.11	—	0.41	0.13	
YAV26LNT12FX						1/2	0.53	0.63	0.81	0.87	2.36	—	0.53	0.13	
YAV27LNT12FX	3/0 AWG	3/0 AWG G,H,I,K,M, DLO	95	Orange	14	1/2	0.53	0.70	1.00	0.76	2.59	—	0.53	0.14	1-1/16
YAV28LNT516FX	4/0 AWG	4/0 AWG G,H,I,K,M, DLO	—	Purple	15	5/16	0.33	0.77	1.03	0.94	2.29	—	0.34	0.15	1-1/16
YAV28LNT38FX						3/8	0.41	0.77	1.03	0.94	2.42	—	0.41	0.15	
YAV28LNT12FX						1/2	0.53	0.77	1.03	0.76	2.67	—	0.53	0.15	
YA30LNT516FX	—	250 kcmil G,H	—	Yellow	16	5/16	0.33	0.81	1.03	0.96	2.48	—	0.34	0.15	1-1/8
YA31LNT12FX	—	250 kcmil I,K,M, 262 DLO	150	White	17 or 298	1/2	0.53	0.88	1.06	0.96	2.75	—	0.53	0.18	1-1/8
YA32LNT516FX	—	300 kcmil G,H,I,K,M, 313 DLO	185	Red	18	5/16	0.33	0.95	1.19	0.96	2.65	—	0.34	0.19	1-1/4
YA32LNT38FX						3/8	0.41	0.95	1.19	0.96	2.68	—	0.41	0.19	
YA34LNT38FX	—	350 kcmil G,H,I,K,M 373 DLO	240	Blue	19 or 470	3/8	0.41	1.06	1.27	0.96	2.87	—	0.41	0.23	1-5/16
YA34LNT12FX						1/2	0.53	1.06	1.27	0.96	3.12	—	0.53	0.23	
YA38LNT12FX	—	500 kcmil H,I,K 550 kcmil G,H,I 535 DLO	300	Pink	L99	1/2	0.53	1.25	1.45	1.63	3.41	—	0.53	0.27	1-7/16
YA38LNTM20FX						M20	0.85	1.25	1.45	1.63	3.84	—	0.75	0.27	
YA40LENT12FX	—	650 kcmil G 646 DLO	—	Black	24	1/2	0.53	1.35	1.42	1.35	3.43	—	0.53	0.30	1-5/16
YA44LNT38FX	—	750 kcmil G,H, 777 DLO	500	Yellow	L115	3/8	0.41	1.50	1.65	1.50	3.79	—	0.53	0.33	1-5/8
YA44LNT12FX						1/2	0.56	1.50	1.65	1.62	3.98	—	0.62	0.33	

◆ For applications greater than 2000 volts consult cable manufacturer for voltage stress relief instructions

Notes: All dimensions shown are for reference only.

Field bending straight lugs to achieve an angular connection will void UL Listing / CSA Certifications and BURNDY will not be liable for the connection.

Compression Connections

Copper Compression — Terminal — Flex — One Hole
Standard Barrel, Belled End — with Inspection Window

TYPE YA-LB

HYLUG™

Uninsulated Copper Compression Terminal
UL Listed 90° C, Up to 35 kV ♦

45° and 90° angles available. Please contact Customer Service to order:
1-800-346-4175

Features & Benefits

- Inspection windows allows for visual verification that the wire has been fully inserted prior to crimping the lug
- Barrel is designed with a “belled” end opening at the wire entry, to ensure smooth insertion of highly flexible stranded wire, preventing possible damaging of the wire strands during insertion
- Short/Standard length barrel is recommended for installations with limited space requirements
- 45° and 90° angular lugs are available; please contact Customer Service
- Electro-tin plated unless otherwise specified to reduce galvanic corrosion (bimetallic) and resist corrosive elements
- Connectors are clearly marked with stamping and barrel color coding
- Connectors accommodating wire sizes #10 - 250 kcmil accommodate both Flex and Code Wire. See Tables on each page for specific details
- Tables in this section identify flex wire as the nominal flex wire size followed by the wire classes and DLO wire size and stranding. For Class Wire Strand counts, see the table at the beginning of this section.
- BURNDY certifies its products using the BURNDY Engineered System and select other crimp tool manufacturers in accordance with one or more of the UL categories in order to obtain a UL Listing

Accessories

- Hardware - Section F
- PENETROX™ Oxide Inhibitor - Section F
- Heat and Cold Shrink Tubing - Section D
- WIREMIKE™ Wire Micrometer - Section F
- Wire Management (Cable Ties) - Section G

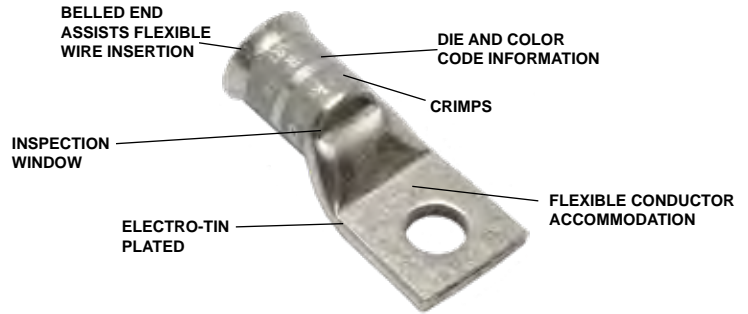

NOTE: Field bending straight lugs to achieve an angular connection will void UL Listing / CSA Certifications and BURNDY will not be liable for the connection.

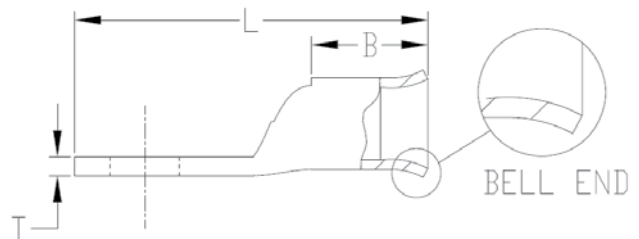
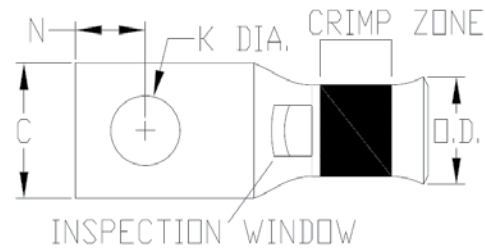

TYPE YA-LB (Continued)

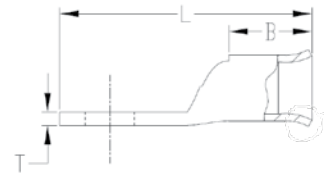
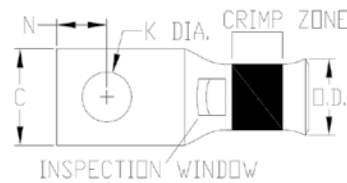

▲ See Copper Flex Standard Barrel Terminal Tooling Tables in this section for complete tool and die listing information.

Catalog Number	Conductor		Die Index	Stud Size	Figure Dimensions								Wire Strip Length
	Code	Flex			Stud Hole Diameter (K)	Outside Diameter (OD)	Barrel Length (B)	Pad Width (C)	Overall Length (L)	Hole Spacing (E) & (F)	Hole Offset (N)	Pad Thickness (T)	
YA8CLB	#8 AWG #6 Sol #8 Sol	#8 AWG G,H,I,K,M DLO	49 Code 1013 Flex	#10	.020	0.27	0.41	0.41	1.12	—	0.20	0.08	7/16
YA5CLB	#5 AWG	#6 AWG G,H,I,K,M DLO	7 Code 1014 Flex	1/4	0.27	0.30	0.44	0.44	1.73	—	0.31	0.07	7/8
YA4CLB	#4 AWG	#5 AWG G,H,I,K,M DLO	8 Code 1015 Flex	1/4	0.27	0.34	0.50	0.50	1.73	—	0.31	0.09	7/8
YA3CLB	#3 AWG	#4 AWG G,H,I,K,M DLO	9 Code 1016 Flex	5/16	0.33	0.38	0.55	0.55	1.94	—	0.34	0.09	15/16
YA2CLB	#2 AWG	#3 AWG G,H,I,K,M DLO	10 Code 1017 Flex	5/16	0.33	0.42	0.61	0.61	1.97	—	0.34	0.11	15/16
YA1CLB	#1 AWG	#2 AWG G,H,I,K,M DLO	11 Code 1018 Flex	5/16	0.33	0.46	0.68	0.68	2.02	—	0.34	0.10	15/16
YA25LB	1/0 AWG	#1 AWG G,H,I,K,M DLO	12 Code 1019 Flex	5/16	0.33	0.51	0.75	0.75	2.26	—	0.34	0.12	15/16
YA26LB	2/0 AWG	1/0 AWG G,H,I,K,M DLO	13 Code 1020 Flex	3/8	0.40	0.56	0.83	0.83	2.61	—	0.41	0.12	1
YA27LB	3/0 AWG	2/0 AWG G,H,I,K,M DLO	14 Code 1021 Flex	1/2	0.53	0.62	0.91	0.91	2.67	—	0.53	0.12	1-1/16
YA28LB	4/0 AWG	3/0 AWG G,H,I,K,M DLO	15 Code 1022 Flex	1/2	0.53	0.69	1.02	1.02	2.77	—	0.53	0.14	1-1/16
YA29LB	250 kcmil	4/0 AWG G,H	16 Code 1023 Flex	1/2	0.53	0.75	1.11	1.11	2.82	—	0.53	0.16	1-1/16
YA30LB	300 kcmil	250 kcmil G,H 4/0 AWG I,K,M DLO	17 Code 1024 Flex	1/2	0.53	0.81	1.20	1.20	2.93	—	0.53	0.16	1-1/8
YA31LB	350 kcmil	250 kcmil I,K,M 262 DLO	18 Code 1025 Flex	1/2	0.53	0.88	1.29	1.29	3.31	—	0.53	0.18	1-3/16
YA32LB	400 kcmil	300 kcmil G,H,I,K,M 313 DLO	19 Code 1026 Flex	5/8	0.69	0.95	1.40	1.40	3.56	—	0.66	0.19	1-1/4
YA34LB	500 kcmil	350 kcmil G,H,I,K,M 373 DLO 400 kcmil G,H,I	20 Code 1027 Flex	5/8	0.69	1.06	1.52	1.52	3.83	—	0.66	0.23	1-7/16
YA36LB	600 kcmil	450 kcmil I,K,M 444 DLO 500 kcmil G&H	22 Code 1028 Flex	5/8	0.69	1.18	1.69	1.69	4.31	—	0.88	0.25	1-3/4
YA38LB	700 kcmil	500 kcmil I,K,M 535 DLO 550 kcmil G,H,I	23 Code 1029 Flex	5/8	0.69	1.25	1.81	1.81	4.27	—	0.88	0.27	1-15/16
YA39LB	750 kcmil	600 kcmil G 550 kcmil M	24 Code 1030 Flex	5/8	0.69	1.30	1.89	1.89	4.27	—	0.88	0.27	1-15/16
YA40LB	800 kcmil	600 kcmil H,I,K,M	25 Code 1031 Flex	5/8	0.69	1.35	1.95	1.95	4.27	—	0.94	0.30	1-15/16
YA44LB	1000 kcmil	650 kcmil I 750 kcmil G,H 777 DLO	27 Code 1032 Flex	5/8	0.69	1.49	2.17	2.18	4.50	—	0.66	0.32	1-15/16

◆ For applications greater than 2000 volts consult cable manufacturer for voltage stress relief instructions

* 644 and 444 Series for use on Code Wire Only

Notes: All dimensions shown are for reference only.

Field bending straight lugs to achieve an angular connection will void UL Listing / CSA Certifications and BURNDY will not be liable for the connection.

Compression Connections

Copper Compression — Terminal — Flex — One Hole
Standard Barrel, Tin-Zinc Plated — No Inspection Window

TYPE YAG-L-FXTZ

HYTIN-ZCLAD™

Uninsulated Copper Compression Terminal, Tin-Zinc Plated
UL Listed 90° C, Up to 35 kV ♦

45° and 90° angles available. Please contact Customer Service to order:
1-800-346-4175

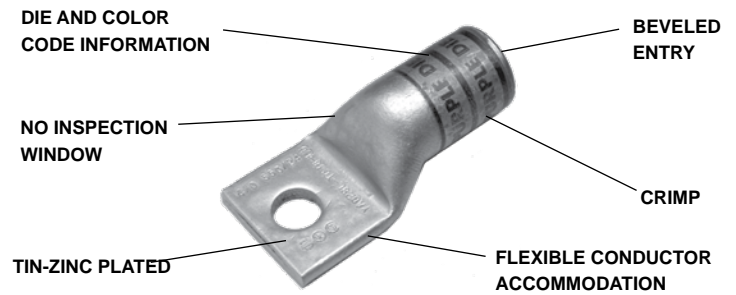

Features & Benefits

- No inspection window is ideal for more corrosive environments as the barrel transition is not open
- Barrel is designed with an internal chamfer at the wire entry to ensure smooth insertion of the wire, preventing possible damaging of the wire strands during insertion
- Short/Standard length barrel is recommended for installations with limited space requirements
- 45° and 90° angular lugs are available; please contact Customer Service
- Tin-Zinc plated for battery connectors or other heavy duty equipment, to reduce the corrosion from lead/acid batteries
- Connectors are clearly marked with stamping and barrel color coding
- Connectors accommodating wire sizes #10 - 250 kcmil accommodate both Flex and Code Wire. See Tables on each page for specific details
- BURNDY certifies its products using the BURNDY Engineered System and select other crimp tool manufacturers in accordance with one or more of the UL categories in order to obtain a UL Listing

NOTE: Field bending straight lugs to achieve an angular connection will void UL Listing / CSA Certifications and BURNDY will not be liable for the connection.

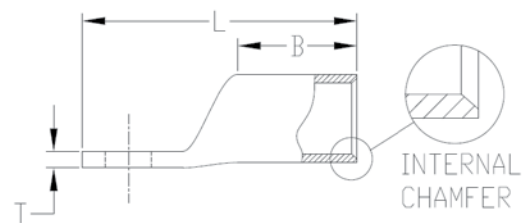
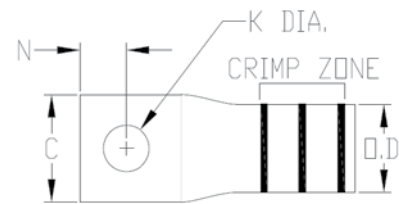

Accessories

- Hardware - Section F
- PENETROX™ Oxide Inhibitor - Section F
- Heat and Cold Shrink Tubing - Section D
- WIREMIKE™ Wire Micrometer - Section F
- Wire Management (Cable Ties) - Section G

TYPE YAG-L-FXTZ (Continued)

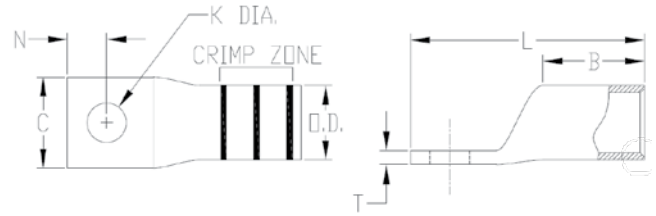

▲ See Copper Flex Standard Barrel Terminal Tooling Tables in this section for complete tool and die listing information.

Catalog Number	Conductor			Color Code	Die Index	Stud Size	Figure Dimensions							Wire Strip Length	
	Code	Flex	Metric MM ² ***				Stud Hole Diameter (K)	Outside Diameter (OD)	Barrel Length (B)	Pad Width (C)	Overall Length (L)	Hole Spacing (E) & (F)	Hole Offset (N)		Pad Thickness (T)
YAG8CLTC14FXTZ	#8 AWG	#8 AWG	10	Red	49	1/4	0.27	0.27	0.44	0.44	1.32	—	0.31	0.08	1/2
YAG8CLTC38FXTZ	#6 Sol #8 Sol	G,H,I,K,M DLO				3/8	0.41	0.27	0.44	0.58	1.51	—	0.34	0.06	
YAG6CLTC14FXTZ	#6 AWG	#6 AWG G,H,I,K,M DLO	16	Blue	7	1/4	0.27	0.31	0.50	0.48	1.43	—	0.31	0.08	1/2
YAG6CLTC516FXTZ						5/16	0.33	0.31	0.50	0.52	1.49	—	0.34	0.07	
YAG6CLTC38FXTZ						3/8	0.40	0.31	0.50	0.58	1.61	—	0.41	0.06	
YAG6CLTC12FXTZ						1/2	0.53	0.31	0.50	0.75	1.86	—	0.53	0.12	
YAG4CLTC14FXTZ	#4 AWG	#4 AWG G,H,I,K,M DLO	—	Gray	8	1/4	0.27	0.38	0.50	0.55	1.48	—	0.31	0.09	1/2
YAG4CLTC516FXTZ						5/16	0.33	0.38	0.50	0.55	1.55	—	0.34	0.09	
YAG4CLTC38FXTZ						3/8	0.40	0.38	0.50	0.58	1.67	—	0.41	0.08	
YAG2CLTC14FXTZ	#2 AWG	#2 AWG G,H,I,K,M DLO	35	Brown	10	1/4	0.27	0.46	0.63	0.68	1.64	—	0.31	0.10	11/16
YAG2CLTC516FXTZ						5/16	0.33	0.46	0.63	0.68	1.70	—	0.34	0.10	
YAG2CLTC38FXTZ						3/8	0.40	0.46	0.63	0.68	1.83	—	0.41	0.10	
YAG2CLTC12FXTZ						1/2	0.53	0.46	0.63	0.73	2.12	—	0.53	0.09	
YAG1CLTC516FXTZ	#1 AWG	#1 AWG G,H,I,K,M DLO	—	Green	11	5/16	0.33	0.51	0.69	0.75	1.73	—	0.34	0.12	11/16
YAG25LTC38FXTZ	1/0 AWG	1/0 AWG G,H,I,K,M DLO	50	Pink	12	3/8	0.41	0.56	0.69	0.83	1.96	—	0.41	0.12	11/12
YAG25LTC12FXTZ						1/2	0.53	0.56	0.69	0.83	2.21	—	0.53	0.12	
YAG26LTC38FXTZ	2/0 AWG	2/0 AWG G,H,I,K,M DLO	70	Black	13	3/8	0.40	0.63	0.81	0.93	2.13	—	0.41	0.13	13/16
YAG26LTC516FXTZ						5/16	0.33	0.63	0.81	0.93	2.01	—	0.34	0.13	
YAG26LTC12FXTZ						1/2	0.53	0.63	0.81	0.93	2.38	—	0.53	0.13	
YAG27LTC14FXTZ	3/0 AWG	3/0 AWG G,H,I,K,M DLO	95	Orange	14	1/4	0.27	0.70	1.00	1.03	2.18	—	0.31	0.14	1
YAG27LTC38FXTZ						3/8	0.40	0.70	1.00	1.03	2.37	—	0.41	0.14	
YAG27LTC12FXTZ						1/2	0.53	0.70	1.00	1.03	2.62	—	0.53	0.14	
YAG28LTC14FXTZ	4/0 AWG	4/0 AWG G,H,I,K,M DLO	120	Purple	15	1/4	0.27	0.77	1.03	1.14	2.26	—	0.31	0.15	1-1/16
YAG28LTC516FXTZ						5/16	0.33	0.77	1.03	1.14	2.32	—	0.34	0.15	
YAG28LTC516N66FXTZ						5/16	0.33	0.77	1.03	1.14	2.64	—	0.66	0.15	
YAG28LTC38FXTZ						3/8	0.41	0.77	1.03	1.14	2.45	—	0.41	0.15	
YAG28LTC12FXTZ						1/2	0.53	0.77	1.03	1.14	2.70	—	0.53	0.15	
YAG28LTC58FXTZ						5/8	0.69	0.77	1.03	1.14	2.95	—	0.66	0.15	

◆ For applications greater than 2000 volts consult cable manufacturer for voltage stress relief instructions

Notes: All dimensions shown are for reference only.

Field bending straight lugs to achieve an angular connection will void UL Listing / CSA Certifications and BURNDY will not be liable for the connection.

Compression Connections

Copper Compression — Terminal — Flex — One Hole
Standard Barrel, Tin-Zinc Plated — No Inspection Window

TYPE YAG-L-FXTZ (Continued)

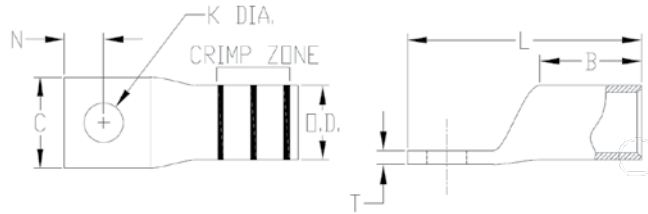

▲ See Copper Flex Standard Barrel Terminal Tooling Tables in this section for complete tool and die listing information.

Catalog Number	Conductor			Color Code	Die Index	Stud Size	Figure Dimensions								Wire Strip Length
	Code	Flex	Metric MM ² ***				Stud Hole Diameter (K)	Outside Diameter (OD)	Barrel Length (B)	Pad Width (C)	Overall Length (L)	Hole Spacing (E) & (F)	Hole Offset (N)	Pad Thickness (T)	
YAG29LTC516FXTZ	250 kcmil	4/0 AWG G,H,I,K,M DLO	—	Yellow	16	5/16	0.33	0.80	1.03	1.18	2.33	—	0.34	0.16	1-1/16
YAG29LTC38FXTZ						3/8	0.40	0.80	1.03	1.18	2.45	—	0.41	0.16	
YAG32LTC58FXTZ	—	350 kcmil D,H,I,K,M DLO 313	185	Red	18	5/8	0.69	0.95	1.19	1.40	3.22	—	0.66	0.19	1-1/4
YAG34LTC516FXTZ	—	350 kcmil G,H,I,K,M DLO 373	240	Blue	19	5/16	0.33	1.06	1.27	1.55	2.78	—	0.34	0.23	1-5/16
YAG34LTC516N66FXTZ						5/16	0.33	1.06	1.27	1.54	3.09	—	0.66	0.23	
YAG34LTC38FXTZ						3/8	0.41	1.06	1.27	1.55	2.91	—	0.41	0.23	
YAG34LTC12FXTZ						1/2	0.53	1.06	1.27	1.55	3.16	—	0.53	0.23	
YAG38LTC58FXTZ	—	500 kcmil H,I,K 550 kcmil G,H,I DLO 535	300	Pink	L99	5/8	0.69	1.25	1.45	1.84	3.71	—	0.66	0.27	1-7/16
YAG40LTC12FXTZ	—	650 kcmil G DLO 646	400	Black	24	1/2	0.53	1.35	1.42	1.96	3.48	—	0.53	0.30	1-5/16

◆ For applications greater than 2000 volts consult cable manufacturer for voltage stress relief instructions

Notes: All dimensions shown are for reference only.

Field bending straight lugs to achieve an angular connection will void UL Listing / CSA Certifications and BURNDY will not be liable for the connection.

TYPES YA-L-2TC, YA-L-2TC-FX, YAV-L-2TC-FX

HYLUG™

Uninsulated Copper Compression Terminal
UL Listed 90° C, Up to 35 kV ◆

45° and 90° angles available. Please contact Customer Service to order:
1-800-346-4175

Features & Benefits

- Inspection windows allows for visual verification that the wire has been fully inserted prior to crimping the lug
- Barrel is designed with an internal chamfer at the wire entry to ensure smooth insertion of the wire, preventing possible damaging of the wire strands during insertion
- Short/Standard length barrel is recommended for installations with limited space requirements
- Two hole tongue/tang is recommended when space permits as the 2-hole feature minimizes the terminations from loosening or rotating under vibration, movement, or heat cycling
- 45° and 90° angular lugs are available; please contact Customer Service
- Electro-tin plated unless otherwise specified to reduce galvanic corrosion (bimetallic) and resist corrosive elements
- Connectors are clearly marked with stamping and barrel color coding
- Connectors accommodating wire sizes #10 - 250 kcmil accommodate both Flex and Code Wire. See Tables on each page for specific details
- Tables in this section identify flex wire as the nominal flex wire size followed by the wire classes and DLO wire size and stranding. For Class Wire Strand counts, see the table at the beginning of this section.
- BURNDY certifies its products using the BURNDY Engineered System and select other crimp tool manufacturers in accordance with one or more of the UL categories in order to obtain a UL Listing

Accessories

- Hardware - Section F
- PENETROX™ Oxide Inhibitor - Section F
- Heat and Cold Shrink Tubing - Section D
- WIREMIKE™ Wire Micrometer - Section F
- Wire Management (Cable Ties) - Section G

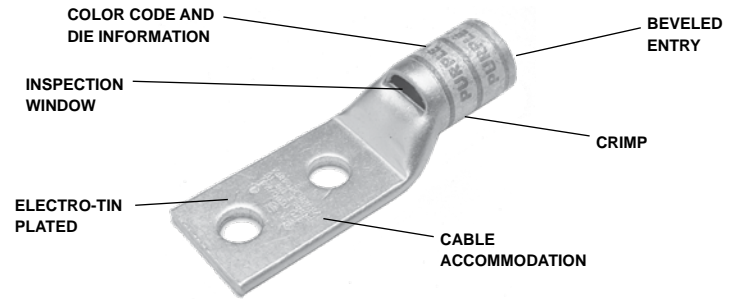

NOTE: Field bending straight lugs to achieve an angular connection will void UL Listing / CSA Certifications and BURNDY will not be liable for the connection.

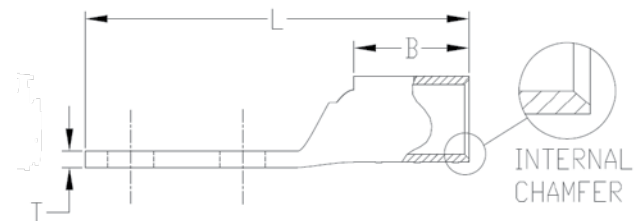
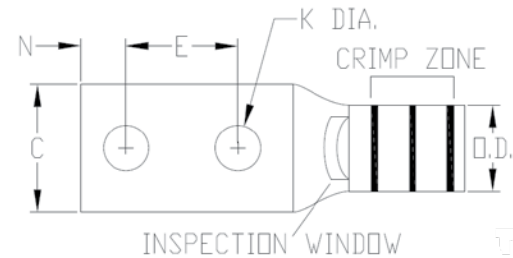

Compression Connections

Copper Compression — Terminal — Flex — Two Hole
Standard Barrel — with Inspection Window

TYPES YA-L-2TC, YA-L-2TC-FX, YAV-L-2TC-FX (Continued)

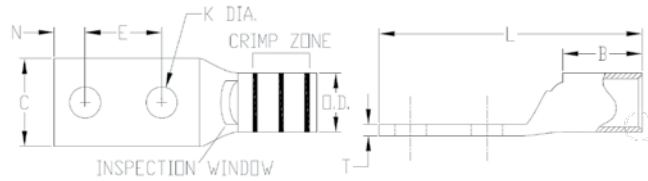

▲ See Copper Flex Standard Barrel Terminal Tooling Tables in this section for complete tool and die listing information.

Catalog Number	Conductor			Color Code	Die Index	Stud Size	Figure Dimensions							Wire Strip Length	
	Code	Flex	Metric MM* ***				Stud Hole Diameter (K)	Outside Diameter (OD)	Barrel Length (B)	Pad Width (C)	Overall Length (L)	Hole Spacing (E & F)	Hole Offset (N)		Pad Thickness (T)
YA8CL2TC10	#8 AWG #6 Sol #8 Sol	#8 AWG G,H,I,K,M DLO	10	Red	49	#10	0.21	0.27	0.44	0.41	1.83	5/8	0.25	0.08	7/16
YA8CL2TC14						1/4	0.27	0.27	0.44	0.44	1.95	5/8	0.31	0.08	
YA8CL2TC14E2						1/4	0.27	0.27	0.44	0.44	2.08	3/4	0.31	0.08	
YA8CL2TC14E1						1/4	0.27	0.27	0.44	0.44	2.33	1	0.31	0.08	
YA8CL2TC38						3/8	0.40	0.27	0.44	0.58	2.52	1	0.41	0.06	
YAV6CL2TC10E9FX	#6 AWG	#6 AWG G,H,I,K,M, DLO	16	Blue	7	#10	0.21	0.31	0.50	0.48	1.81	1/2	0.25	0.08	1/2
YAV6CL2TC10FX						#10	0.21	0.31	0.50	0.45	1.94	5/8	0.25	0.08	
YAV6CL2TC10E4FX						#10	0.21	0.31	0.50	0.45	2.00	11/16	0.25	0.08	
YAV6CL2TC10E2FX						#10	0.21	0.31	0.50	0.48	2.06	3/4	0.25	0.08	
YAV6CL2TC14FX						1/4	0.27	0.31	0.50	0.48	2.06	5/8	0.31	0.08	
YAV6CL2TC14E2FX						1/4	0.27	0.31	0.50	0.48	2.16	3/4	0.31	0.08	
YAV6CL2TC14E1FX						1/4	0.27	0.31	0.50	0.48	2.44	1	0.31	0.08	
YAV6CL2TC516FX						5/16	0.33	0.31	0.50	0.52	2.50	1	0.34	0.07	
YAV6CL2TC38FX						3/8	0.40	0.31	0.50	0.58	2.62	1	0.41	0.06	
YAV6CL2NTCFX						1/2	0.56	0.31	0.50	0.83	3.81	1-3/4	0.62	0.12	
YAV4CL2TC14FX						#4 AWG	#4 AWG G,H,I,K,M, DLO	—	Gray	8	1/4	0.27	0.38	0.50	
YAV4CL2TC14E2FX	1/4	0.27	0.38	0.50	0.55						2.20	3/4	0.31	0.09	
YAV4CL2TC14E1FX	1/4	0.27	0.38	0.50	0.55						2.45	1	0.31	0.09	
YAV4CL2TC516FX	5/16	0.33	0.38	0.50	0.55						2.52	1	0.34	0.09	
YAV4CL2TC38FX	3/8	0.40	0.38	0.50	0.58						2.68	1	0.41	0.08	
YAV4CL2NTCFX	1/2	0.56	0.38	0.50	0.83						3.87	1-3/4	0.62	0.12	
YAV2CL2TC14FX	#2 AWG	#2 AWG G,H,I,K,M, DLO	35	Brown	10	1/4	0.27	0.46	0.63	0.68	2.26	5/8	0.31	0.10	11/16
YAV2CL2TC14E2FX						1/4	0.27	0.46	0.63	0.68	2.38	3/4	0.31	0.10	
YAV2CL2TC14E1FX						1/4	0.27	0.46	0.63	0.68	2.63	1	0.31	0.10	
YAV2CL2TC516FX						5/16	0.33	0.46	0.63	0.68	2.71	1	0.34	0.10	
YAV2CL2TC38FX						3/8	0.40	0.46	0.63	0.68	2.82	1	0.41	0.10	
YAV2CL2NTCFX						1/2	0.56	0.46	0.63	0.83	4.07	1-3/4	0.62	0.08	
YAV1CL2TC14FX	#1 AWG	#1 AWG G,H,I,K,M, DLO	—	Green	11	1/4	0.27	0.51	0.62	0.75	2.28	5/8	0.31	0.12	11/16
YAV1CL2TC14E2FX						1/4	0.27	0.51	0.62	0.75	2.41	3/4	0.31	0.12	
YAV1CL2TC14E1FX						1/4	0.27	0.51	0.62	0.75	2.65	1	0.31	0.12	
YAV1CL2TC516FX						5/16	0.33	0.51	0.62	0.75	2.72	1	0.34	0.12	
YAV1CL2TC38FX						3/8	0.41	0.51	0.62	0.75	2.85	1	0.41	0.12	
YAV1CL2NTCFX						1/2	0.56	0.51	0.62	0.83	4.04	1-3/4	0.62	0.11	

◆ For applications greater than 2000 volts consult cable manufacturer for voltage stress relief instructions

Notes: All dimensions shown are for reference only.

Field bending straight lugs to achieve an angular connection will void UL Listing / CSA Certifications and BURNDY will not be liable for the connection.

TYPES YA-L-2TC, YA-L-2TC-FX, YAV-L-2TC-FX (Continued)

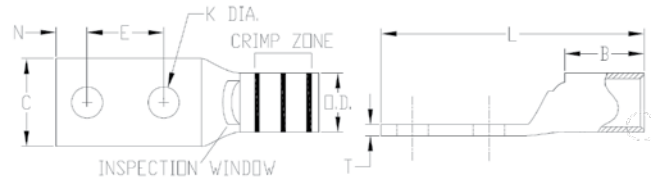

▲ See Copper Flex Standard Barrel Terminal Tooling Tables in this section for complete tool and die listing information.

Catalog Number	Conductor			Color Code	Die Index	Stud Size	Figure Dimensions								Wire Strip Length
	Code	Flex	Metric MM ² ***				Stud Hole Diameter (K)	Outside Diameter (OD)	Barrel Length (B)	Pad Width (C)	Overall Length (L)	Hole Spacing (E & F)	Hole Offset (N)	Pad Thickness (T)	
YAV25L2TC14FX	1/0 AWG	G,H,I,K,M, DLO	50	Pink	12	1/4	0.27	0.56	0.69	0.83	2.39	5/8	0.31	0.12	11/16
YAV25L2TC14E2FX						1/4	0.27	0.56	0.69	0.83	2.51	3/4	0.31	0.12	
YAV25L2TC516E2FX						5/16	0.33	0.56	0.69	0.83	2.57	3/4	0.34	0.12	
YAV25L2TC516FX						5/16	0.33	0.56	0.69	0.83	2.82	1	0.34	0.12	
YAV25L2TC38FX						3/8	0.40	0.56	0.69	0.83	2.95	1	0.41	0.12	
YAV25L2TC12E1FX						1/2	0.53	0.56	0.69	0.83	3.20	1	0.53	0.12	
YAV25L2NTCFX						1/2	0.56	0.56	0.69	0.83	4.14	1-3/4	0.63	0.12	
YAV26L2TC14FX	2/0 AWG	G,H,I,K,M, DLO	70	Black	13	1/4	0.27	0.63	0.81	0.93	2.56	5/8	0.31	0.13	13/16
YAV26L2TC14E2FX						1/4	0.27	0.63	0.81	0.93	2.68	3/4	0.31	0.13	
YAV26L2TC516FX						5/16	0.33	0.63	0.81	0.93	2.99	1	0.34	0.13	
YAV26L2TC38FX						3/8	0.41	0.63	0.81	0.93	3.12	1	0.41	0.13	
YAV26L2TC38E10FX						3/8	0.41	0.63	0.81	0.93	3.37	1-1/4	0.41	0.13	
YAV26L2TC12E1FX						1/2	0.53	0.63	0.81	0.93	3.37	1	0.53	0.13	
YAV26L2NTCFX						1/2	0.56	0.63	0.81	0.93	4.31	1-3/4	0.63	0.13	
YAV27L2TC14FX	3/0 AWG	G,H,I,K,M, DLO	95	Orange	14	1/4	0.27	0.70	1.00	1.03	2.79	5/8	0.31	0.14	1
YAV27L2TC38FX						3/8	0.41	0.70	1.00	1.03	3.35	1	0.41	0.14	
YAV27L2NTCFX						1/2	0.56	0.70	1.00	1.03	4.54	1.75	0.63	0.14	
YAV28L2TC14E2FX	4/0 AWG	G,H,I,K,M, DLO	120	Purple	15	1/4	0.27	0.77	1.03	1.14	2.99	3/4	0.31	0.15	1-1/16
YAV28L2TC14FX						1/4	0.27	0.77	1.03	1.14	2.86	5/8	0.31	0.15	
YAV28L2TC516FX						5/16	0.33	0.77	1.03	1.14	3.30	1	0.34	0.15	
YAV28L2TC38FX						3/8	0.40	0.77	1.03	1.14	3.43	1	0.41	0.15	
YAV28L2TC12E1FX						1/2	0.53	0.77	1.03	1.14	3.68	1	0.53	0.15	
YAV28L2TC12FX						1/2	0.53	0.77	1.03	1.14	3.93	1-1/4	0.53	0.15	
YAV28L2NTCFX						1/2	0.56	0.77	1.03	1.14	4.62	1-3/4	0.63	0.15	
YAV29L2TC14FX	250 kcmil	G,H,I,K,M, DLO	—	Yellow	16	1/4	0.27	0.80	1.03	1.18	2.87	5/8	0.31	0.16	1-1/16
YAV29L2TC14E2FX						1/4	0.27	0.80	1.03	1.18	2.99	3/4	0.31	0.16	
YAV29L2TC516FX						5/16	0.33	0.80	1.03	1.18	3.31	1	0.34	0.16	
YAV29L2TC38FX						3/8	0.40	0.80	1.03	1.18	3.43	1	0.41	0.16	
YAV29L2TC12E1FX						1/2	0.53	0.80	1.03	1.18	3.68	1	0.53	0.16	
YAV29L2TC12FX						1/2	0.53	0.80	1.03	1.18	3.93	1-1/4	0.53	0.16	
YAV29L2NTCFX						1/2	0.56	0.80	1.03	1.18	4.62	1-3/4	0.63	0.16	

◆ For applications greater than 2000 volts consult cable manufacturer for voltage stress relief instructions

Notes: All dimensions shown are for reference only.

Field bending straight lugs to achieve an angular connection will void UL Listing / CSA Certifications and BURNDY will not be liable for the connection.

Compression Connections

Copper Compression — Terminal — Flex — Two Hole
Standard Barrel — with Inspection Window

TYPES YA-L-2TC, YA-L-2TC-FX, YAV-L-2TC-FX (Continued)

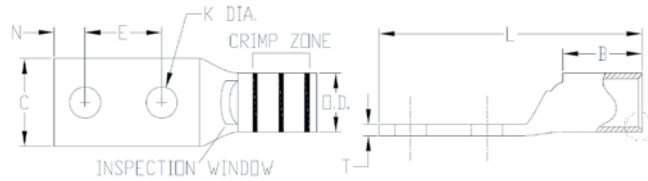

▲ See Copper Flex Standard Barrel Terminal Tooling Tables in this section for complete tool and die listing information.

Catalog Number	Conductor			Color Code	Die Index	Stud Size	Figure Dimensions								Wire Strip Length
	Code	Flex	Metric MM ² ***				Stud Hole Diameter (K)	Outside Diameter (OD)	Barrel Length (B)	Pad Width (C)	Overall Length (L)	Hole Spacing (E & F)	Hole Offset (N)	Pad Thickness (T)	
YA30L2TC516FX	—	250 kcmil G,H	—	Yellow	16	5/16	0.33	0.81	1.03	1.20	3.32	1	0.34	0.16	1-1/16
YA30L2TC38FX						3/8	0.41	0.81	1.03	1.20	3.45	1	0.41	0.16	
YA30L2NTCFX						1/2	0.56	0.81	1.03	1.20	4.63	1-3/4	0.63	0.16	
YA31L2TC38FX	—	250 kcmil I,K,M, DLO 262	150	White	17 or 298	3/8	0.41	0.88	1.06	1.29	3.51	1	0.41	0.18	1-1/8
YA31L2TC12FX						1/2	0.53	0.88	1.06	1.29	4.01	1-1/4	0.53	0.18	
YA31L2NTCFX						1/2	0.56	0.88	1.06	1.29	4.70	1-3/4	0.63	0.18	
YA32L2TC38FX	—	300 kcmil G,H,I,K,M, DLO 313	185	Red	18 or 324	3/8	0.40	0.95	1.19	1.40	3.69	1	0.41	0.19	1-1/4
YA32L2NTCFX						1/2	0.56	0.95	1.19	1.40	4.88	1-3/4	0.63	0.19	
YA34L2TC516FX	—	350 kcmil G,H,I,K,M, DLO 373	240	Blue	19 or 470	5/16	0.33	1.06	1.27	1.55	3.75	1	0.34	0.23	1-5/16
YA34L2TC38FX						3/8	0.41	1.06	1.27	1.55	3.88	1	0.41	0.23	
YA34L2NTC38FX						3/8	0.41	1.06	1.27	1.55	4.63	1-3/4	0.41	0.23	
YA34L2TC12FX						1/2	0.53	1.06	1.27	1.55	4.38	1-1/4	0.53	0.23	
YA34L2NTCFX						1/2	0.56	1.06	1.27	1.55	5.06	1-3/4	0.63	0.23	
YA36L2TC38FX	—	500 kcmil G,H, DLO 444	—	Brown	20 or 299	3/8	0.40	1.19	1.38	1.74	4.24	1	0.50	0.27	1-7/16
YA36L2NTCFX						1/2	0.56	1.19	1.38	1.74	5.24	1-3/4	0.63	0.27	
YA38L2TC516FX	—	500 kcmil H,I,K 550 kcmil G,H,I DLO 535	300	Pink	L99	5/16	0.33	1.25	1.45	1.84	4.04	1	0.34	0.27	1-7/16
YA38L2TC38FX						3/8	0.40	1.25	1.45	1.84	4.35	1	0.50	0.27	
YA38L2TC12FX						1/2	0.53	1.25	1.45	1.84	4.67	1-1/4	0.53	0.27	
YA38L2NTCFX						1/2	0.56	1.25	1.45	1.84	5.35	1-3/4	0.63	0.27	
YA39L2TC38E10FX	—	600 kcmil G,H,I,K, DLO	—	Pink	400	3/8	0.41	1.30	1.42	1.91	4.61	1-3/4	0.50	0.27	1-1/2
YA39L2NTCFX						1/2	0.56	1.30	1.42	1.91	5.36	1-3/4	0.63	0.27	
YA40L2TC38FX	—	650 kcmil G, DLO 646	400	Black	24	3/8	0.41	1.30	1.42	1.98	4.38	1	0.50	0.30	1-5/16
YA40L2NTCFX						1/2	0.56	1.50	1.42	1.98	5.38	1-3/4	0.63	0.30	
YA44L2TC38FX	—	750 kcmil G,H, DLO 777	500	Yellow	L115	3/8	0.40	1.50	1.65	2.19	4.74	1	0.50	0.33	1-5/8
YA44L2TC12FX						1/2	0.53	1.50	1.65	2.19	5.05	1-1/4	0.53	0.33	
YA44L2TC12E3FX						1/2	0.53	1.50	1.65	2.19	5.30	1-1/2	0.53	0.33	
YA44L2NTCFX						1/2	0.56	1.50	1.65	2.19	5.74	1-3/4	0.63	0.33	
YA44L2TC58FX						5/8	0.69	1.50	1.65	2.19	5.55	1-1/2	0.66	0.33	

◆ For applications greater than 2000 volts consult cable manufacturer for voltage stress relief instructions

Notes: All dimensions shown are for reference only.

Field bending straight lugs to achieve an angular connection will void UL Listing / CSA Certifications and BURNDY will not be liable for the connection.

TYPE YAV-L-2NT-FX

HYLUG™

Uninsulated Copper Compression Terminal
UL Listed 90° C, Up to 35 kV ◆

45° and 90° angles available. Please contact Customer Service to order:
1-800-346-4175

Features & Benefits

- Inspection windows allows for visual verification that the wire has been fully inserted prior to crimping the lug
- Narrow tongue/tang is designed to allow for more parallel terminations of wire in limited space applications
- Barrel is designed with an internal chamfer at the wire entry to ensure smooth insertion of the wire, preventing possible damaging of the wire strands during insertion
- Short/Standard length barrel is recommended for installations with limited space requirements
- Two hole tongue/tang is recommended when space permits as the 2-hole feature minimizes the terminations from loosening or rotating under vibration, movement, or heat cycling
- 45° and 90° angular lugs are available; please contact Customer Service
- Electro-tin plated unless otherwise specified to reduce galvanic corrosion (bimetallic) and resist corrosive elements
- Connectors are clearly marked with stamping and barrel color coding
- Connectors accommodating wire sizes #10 - 250 kcmil accommodate both Flex and Code Wire. See Tables on each page for specific details
- Tables in this section identify flex wire as the nominal flex wire size followed by the wire classes and DLO wire size and stranding. For Class Wire Strand counts, see the table at the beginning of this section.
- BURNDY certifies its products using the BURNDY Engineered System and select other crimp tool manufacturers in accordance with one or more of the UL categories in order to obtain a UL Listing

Accessories

- Hardware - Section F
- PENETROX™ Oxide Inhibitor - Section F
- Heat and Cold Shrink Tubing - Section D
- WIREMIKE™ Wire Micrometer - Section F
- Wire Management (Cable Ties) - Section G

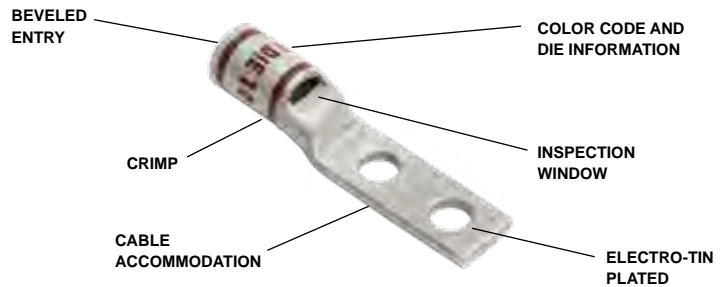

NOTE: Field bending straight lugs to achieve an angular connection will void UL Listing / CSA Certifications and BURNDY will not be liable for the connection.

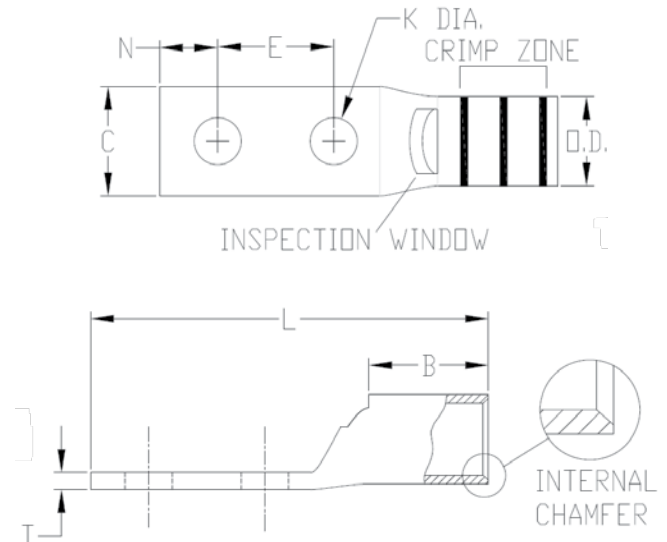

Compression Connections

Copper Compression — Terminal — Flex — Two Hole
Narrow Tongue, Standard Barrel — with Inspection Window

TYPE YAV-L-2NT-FX (Continued)

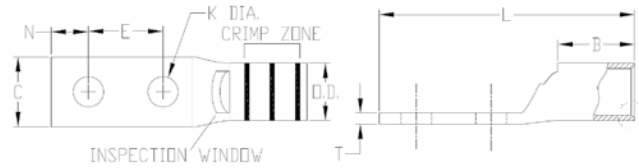

▲ See Copper Flex Standard Barrel Terminal Tooling Tables in this section for complete tool and die listing information.

Catalog Number	Conductor			Color Code	Die Index	Stud Size	Figure Dimensions								Wire Strip Length
	Code	Flex	Metric MM ² ***				Stud Hole Diameter (K)	Outside Diameter (OD)	Barrel Length (B)	Pad Width (C)	Overall Length (L)	Hole Spacing (E & F)	Hole Offset (N)	Pad Thickness (T)	
YAV4CL2NT10E1FX	#4 AWG	#4 AWG G,H,I,K,M DLO	—	Gray	8	#10	0.21	0.38	0.50	0.41	2.33	1.00	0.25	0.09	9/16
YAV4CL2NT10FX						#10	0.21	0.38	0.50	0.41	1.95	5/8	0.25	0.09	
YAV4CL2NT14FX						1/4	0.27	0.38	0.50	0.45	2.08	.63"	0.31	0.09	
YAV2CL2NT10FX	#2 AWG	#2 AWG G,H,I,K,M DLO	35	Brown	10	#10	0.21	0.46	0.63	0.48	2.14	.63"	0.25	0.10	11/16
YAV2CL2NT14E1FX						1/4	0.27	0.46	0.63	0.48	2.63	1.00"	0.31	0.10	
YAV2CL2NT14FX						1/4	0.27	0.46	0.63	0.48	2.26	.63"	0.31	0.10	
YAV1CL2NT14FX	#1 AWG	#1 AWG G,H,I,K,M DLO	—	Green	11	1/4	0.27	0.51	0.62	0.50	2.28	.63"	0.31	0.12	11/16
YAV1CL2NT516FX						5/16	0.33	0.51	0.63	0.58	2.72	1.00"	0.34	0.12	
YAV25L2NT14E1FX	1/0 AWG	1/0 AWG G,H,I,K,M DLO	50	Pink	12	1/4	0.27	0.56	0.69	0.64	2.76	1.00"	0.31	0.12	13/16
YAV25L2NT14FX						1/4	0.27	0.56	0.69	0.64	2.39	.63"	0.31	0.12	
YAV25L2NT516FX						5/16	0.33	0.56	0.69	0.58	2.82	1.00"	0.34	0.12	
YAV26L2NT14FX	2/0 AWG	2/0 AWG G,H,I,K,M DLO	70	Black	13	1/4	0.27	0.63	0.81	0.76	2.56	0.63"	0.31	0.13	13/16
YAV26L2NT38FX						3/8	0.41	0.63	0.81	0.63	3.23	1.00"	0.41	0.13	
YAV26L2NT516FX						5/16	0.33	0.63	0.81	0.58	2.99	1.00"	0.34	0.13	
YAV28L2ENT14FX	4/0 AWG	4/0 AWG G,H,I,K,M DLO	—	Purple	15	1/4	0.27	0.77	1.03	0.76	2.86	.63	0.31	0.15	1-1/16
YAV28L2NT38FX						3/8	0.40	0.77	1.03	0.94	3.43	1	0.41	0.15	
YAV29L2NT38FX	250 kcmil	4/0 AWG G,H,I,K,M DLO	—	Yellow	16	3/8	0.41	0.80	1.03	0.94	3.43	1	0.41	0.16	1-1/16
YA31L2NT38FX	—	250 kcmil I,K,M DLO 262	150	White	17 or 298	3/8	0.41	0.88	1.06	0.96	3.51	1.00"	0.41	0.18	1-1/8
YA32L2NT38FX	—	300 kcmil G,H,I,K,M DLO 313	185	Red	18	3/8	0.41	0.95	1.19	0.96	3.69	1.00"	0.41	0.20	1-1/4
YA34L2NT38FX	—	350 kcmil G,H,I,K,M DLO 373	240	Blue	19 or 470	3/8	0.41	1.06	1.27	0.96	3.88	1	0.41	0.23	1-5/16
YA36L2NT38FX	—	500 kcmil G,H DLO 444	—	Brown	20	3/8	0.41	1.19	1.38	1.63	4.24	1.00"	0.50	0.27	1-7/16
YA36L2ENT38E10FX						3/8	0.41	1.19	1.38	1.50	4.49	1.25	0.50	0.27	
YA38L2ENT38FX	—	500 kcmil H,I,K 550 kcmil G,H,I DLO 535	300	Pink	L99	3/8	0.41	1.25	1.45	1.50	4.35	1.00"	0.50	0.27	1-7/16
YA38L2NT38FX						3/8	0.41	1.25	1.45	1.63	4.35	1	0.50	0.27	
YA38L2NNTFX						1/2	0.56	1.25	1.45	1.63	5.35	1.75	0.63	0.27	
YA40L2NNTFX	—	650 kcmil G DLO 646	400	Black	24	1/2	0.56	1.35	1.42	1.63	5.38	1.75	0.63	0.30	1-5/16
YA44L2NNTFX	—	750 kcmil G,H DLO 777	500	Yellow	L115	1/2	0.56	1.50	1.65	1.63	5.74	1.75	0.63	0.33	1-5/8
YA44L2NT38FX						3/8	0.41	1.50	1.65	1.63	4.74	1	0.50	0.33	
YA45L2NT38FX	—	929 kcmil DLO	—	White	27	3/8	0.41	1.69	2.00	1.70	5.18	1.00"	0.50	0.38	2-1/16

◆ For applications greater than 2000 volts consult cable manufacturer for voltage stress relief instructions

Notes: All dimensions shown are for reference only.

Field bending straight lugs to achieve an angular connection will void UL Listing / CSA Certifications and BURNDY will not be liable for the connection.

TYPES YA-L2TC-SL, YAV-L2TC-FXSL

HYLUG™

Uninsulated Copper Compression Terminal
UL Listed 90° C, Up to 35 kV ◆



Compression slotted lugs connect copper or tinned copper conductors to bus bars, CPI racks, cabinets or cable runway. Slotted and 90° slotted lugs have one round and one oblong hole to match hole spacing on equipment mounting rails on CPI racks and cabinets and on some bus bars.

NOTE: Field bending straight lugs to achieve an angular connection will void UL Listing / CSA Certifications and BURNDY will not be liable for the connection.

Features & Benefits

- Inspection window allows for visual verification that the wire has been fully inserted prior to crimping the lug
- Barrel is designed with an internal chamfer at the wire entry to ensure smooth insertion of the wire, preventing possible damaging of the wire strands during installation
- Short/standard length barrel is recommended for installations with limited space requirements
- One hole with slotted second hole tongue/tang offers additional flexibility over a standard 2-hole tongue/tang as the slot provides the installer with multiple mounting hole alignments options. The 2-hole feature minimizes the terminations from loosening or rotating under vibration, movement or heat cycling
- 45° and 90° angular lugs are available; please contact Customer Service
- Electro-tin plated unless specified to reduce galvanic corrosion (bimetallic) and resist corrosive elements
- Connectors are clearly marked with stamping and barrel color coding
- BURNDY certifies its products using the BURNDY Engineered System and select other crimp tool manufacturers in accordance with one or more of the UL categories in order to obtain a UL Listing
- Terminals and splices accommodating code wire: Accommodates Code Class B (Concentric, Compressed, Compact) and Class C wire

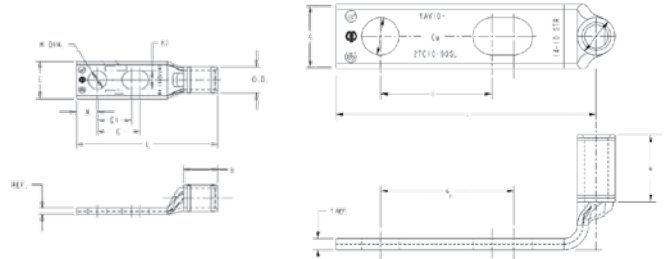

Catalog Number	Cond. Size	Stud Hole Size	Tongue Width	Figure Dimensions					Installation Tooling (# of crimps)					Wire Strip Length	
				(B)	(T)	(L)	(E)	(E1)	Dieless	MD6, OUR840, MD734R	500 Series	35, 750, 46** Series	Color Code		Die Index
YA6CL2TC14E2SL	#6 AWG G,H,I,K,M DLO (61/24)	1/4	0.45	0.81	0.08	2.47	0.62	0.75	MY29 Series (1)	W5CRT (1) W5CVT (1) X5CRT (1) X8CART (1)	W5CRT (1) W5CVT (1)	U5CRT (1) U8CABT (1)	Blue	7 or 374	7/8
YAV6CL2TC10FX90SL*		#10	0.48	0.50	0.08	1.54	0.62	0.75	MY29 Series (1)	W5CRT (1) W5CVT (1) X5CRT (1) X8CART (1)	W5CRT (1) W5CVT (1)	U5CRT (1) U8CABT (1)	Blue	7 or 374	7/8
YAV4CL2TC14FXSL	#4 AWG G,H,I,K,M DLO (105/24)	1/4	0.55	0.50	0.09	2.08	0.50	0.62	MY29 Series (1) 644 Series (1) 444 Series (1) 81K Series (1)	W4CRT (1) W4CVT (1) X4CRT (1)	W4CRT (1) W4CVT (1) X4CRT (1)	U4CRT (1)	Gray	8	9/16
YAV4CL2TC38FXSL		3/8	0.58	0.50	0.08	2.68	0.75	1.00		9/16					
YAV2CL2TC14FXSL	#2 AWG G,H,I,K,M DLO (150/24)	1/4	0.68	0.62	0.10	2.26	0.50	0.62	81K Series (1)	W2CRT (1) W2CVT (1) X2CRT (1)	W2CRT (1) W2CVT (1) X2CRT (1)	U2CRT (1)	Brown	10	11/16
YAV2CL2TC38FXSL		3/8	0.68	0.62	0.10	2.82	0.75	1.0		11/16					
YA44L2NNTFXSL	750 kcmil G,H DLO 777 (1925/24)	5/8	1.63	1.65	0.33	5.74	1.58	1.75	644 Series (1) 444 Series (1) 81K Series (2)	—	—	U44XRT (2)	Yellow	L115	1-2/3

* Denotes 90° Angle

**Use PUADP1 adapter with U dies in 46 Series of tools

Note: All dimensions shown are for reference only.

Compression Connections

Copper Compression — Terminal — Flex — Two Hole
Standard Barrel, Tin-Zinc Plated — No Inspection Window

TYPE YAG-2L-FXTZ

HYTIN-ZCLAD™

Uninsulated Copper Compression Terminal, Tin-Zinc Plated
UL Listed 90° C, Up to 35 kV ♦

45° and 90° angles available. Please contact Customer Service to order:
1-800-346-4175

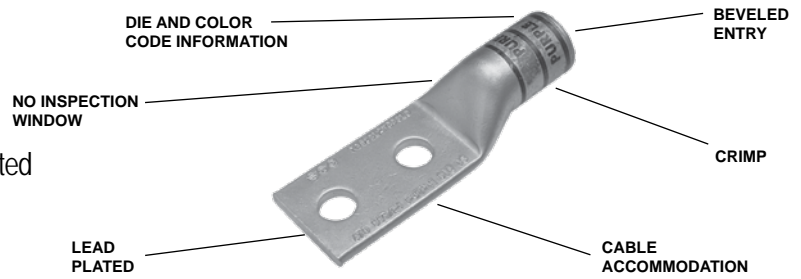

Features & Benefits

- No inspection window is ideal for more corrosive environments as the barrel transition is not open
- Barrel is designed with an internal chamfer at the wire entry to ensure smooth insertion of the wire, preventing possible damaging of the wire strands during insertion
- Short/Standard length barrel is recommended for installations with limited space requirements
- Two hole tongue/tang is recommended when space permits as the 2-hole feature minimizes the terminations from loosening or rotating under vibration, movement, or heat cycling
- 45° and 90° angular lugs are available; please contact Customer Service
- Tin-Zinc plated for battery connectors or other heavy duty equipment, to reduce the corrosion from lead/acid batteries
- Connectors are clearly marked with stamping and barrel color coding
- Connectors accommodating wire sizes #10 - 250 kcmil accommodate both Flex and Code Wire. See Tables on each page for specific details
- BURNDY certifies its products using the BURNDY Engineered System and select other crimp tool manufacturers in accordance with one or more of the UL categories in order to obtain a UL Listing



NOTE: Field bending straight lugs to achieve an angular connection will void UL Listing / CSA Certifications and BURNDY will not be liable for the connection.

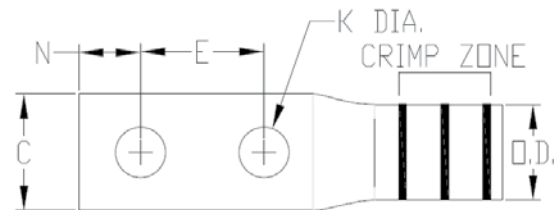

Accessories

- Hardware - Section F
- PENETROX™ Oxide Inhibitor - Section F
- Heat and Cold Shrink Tubing - Section D
- WIREMIKE™ Wire Micrometer - Section F
- Wire Management (Cable Ties) - Section G

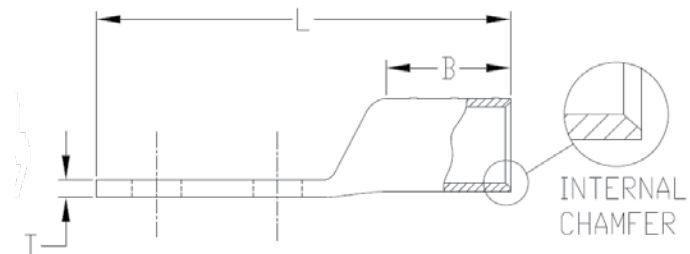

TYPE YAG-2L-FXTZ (Continued)

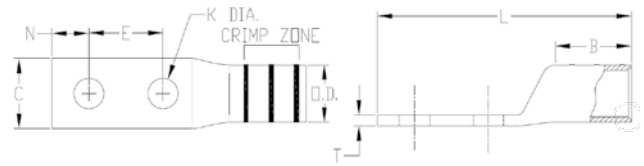

▲ See Copper Flex Standard Barrel Terminal Tooling Tables in this section for complete tool and die listing information.

Catalog Number	Conductor			Color Code	Die Index	Stud Size	Figure Dimensions								Wire Strip Length
	Code	Flex	Metric MM ² ***				Stud Hole Diameter (K)	Outside Diameter (OD)	Barrel Length (B)	Pad Width (C)	Overall Length (L)	Hole Spacing (E) & (F)	Hole Offset (N)	Pad Thickness (T)	
YAG8CL2TC14FXTZ	#8 AWG #6 Sol #8 Sol	#8 AWG G,H,I,K,M DLO	10	Red	49	1/4	0.27	0.27	0.44	0.44	1.95	5/8	0.31	0.08	7/16
YAG8CL2TC14E1FXTZ						1/4	0.27	0.27	0.44	0.44	2.33	1.00	0.31	0.08	
YAG6CL2TC14FXTZ	#6 AWG	#6 AWG G,H,I,K,M DLO (61/24)	16	Blue	7	1/4	0.27	0.31	0.50	0.48	2.06	5/8	0.31	0.08	1/2
YAG4CL2TC14FXTZ	#4 AWG	#4 AWG G,H,I,K,M DLO	—	Gray	8	1/4	0.27	0.38	0.50	0.55	2.11	5/8	0.31	0.09	1/2
YAG2CL2TC14FXTZ	#2 AWG	#2 AWG G,H,I,K,M DLO	35	Brown	10	1/4	0.27	0.46	0.63	0.68	2.28	5/8	0.31	0.10	11/16
YAG2CL2NTCFXTZ						1/2	0.56	0.46	0.63	0.83	4.03	1-3/4	0.62	0.08	
YAG26L2NTCFXTZ	2/0 AWG	2/0 AWG G,H,I,K,M DLO	70	Black	13	1/2	0.56	0.63	0.81	0.93	4.33	1-3/4	0.63	0.13	13/16
YAG27L2NTCFXTZ	3/0 AWG	3/0 AWG G,H,I,K,M DLO	95	Orange	14	1/2	0.56	0.70	1.00	1.03	4.56	1-3/4	0.63	0.14	1
YAG28L2TC516FXTZ	4/0 AWG	4/0 AWG G,H,I,K,M DLO	120	Purple	15	5/16	0.33	0.77	1.03	1.14	3.33	1.00	0.34	0.15	1-1/16
YAG28L2TC38FXTZ						3/8	0.41	0.77	1.03	1.14	3.46	1.00	0.41	0.15	
YAG28L2NT38FXTZ						3/8	0.41	0.77	1.03	0.94	3.48	1.00	0.41	0.17	
YAG28L2TC38FXDITZ						3/8	0.41	0.77	1.03	1.14	3.46	1.00	0.41	0.15	
YAG28L2NTCFXTZ						1/2	0.56	0.77	1.03	1.14	4.65	1-3/4	0.63	0.15	
YAG29L2TC38FXTZ	250 kcmil	4/0 AWG G,H,I,K,M DLO	—	Yellow	16	3/8	0.41	0.80	1.03	1.18	3.43	1.00	0.41	0.16	1-1/16
YAG29L2NT38FXTZ						3/8	0.41	0.80	1.03	0.94	3.48	1.00	0.41	0.16	
YAG29L2NT38FX90TZ						3/8	0.41	0.80	1.03	0.94	2.36	1.00	0.41	0.16	
YAG29L2NTCFXTZ						1/2	0.56	0.80	1.03	1.18	4.65	1-3/4	0.63	0.16	
YAG31L2NTC38FXTZ	—	250 kcmil I,K,M DLO 262	150	White	17	3/8	0.41	0.88	1.06	1.29	3.54	1-3/4	0.41	0.18	1-1/8
YAG34L2TC38FXTZ	—	350 kcmil G,H,I,K,M DLO 373	240	Blue	19	3/8	0.41	1.06	1.27	1.55	3.92	1.00	0.41	0.23	1-5/16
YAG34L2NTCFXTZ						1/2	0.56	1.06	1.27	1.55	5.11	1-3/4	0.63	0.23	

◆ For applications greater than 2000 volts consult cable manufacturer for voltage stress relief instructions

Notes: All dimensions shown are for reference only.

Field bending straight lugs to achieve an angular connection will void UL Listing / CSA Certifications and BURNDY will not be liable for the connection.

Compression Connections

Copper Compression — Terminal — Flex — Two Hole
Standard Barrel, Tin-Zinc Plated — No Inspection Window

TYPE YAG-2L-FXTZ (Continued)

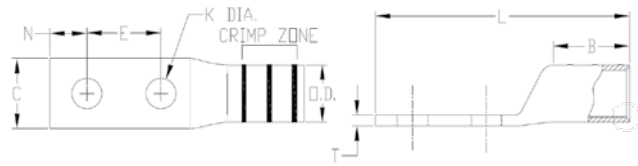

▲ See Copper Flex Standard Barrel Terminal Tooling Tables in this section for complete tool and die listing information.

Catalog Number	Conductor			Color Code	Die Index	Stud Size	Figure Dimensions								Wire Strip Length
	Code	Flex	Metric MM ² ***				Stud Hole Diameter (K)	Outside Diameter (OD)	Barrel Length (B)	Pad Width (C)	Overall Length (L)	Hole Spacing (E) & (F)	Hole Offset (N)	Pad Thickness (T)	
YAG38L2TC12FXTZ	—	500 kcmil H,I,K	300	Pink	20	1/2	0.53	1.25	1.45	1.82	4.72	1-1/4	0.53	0.27	1-3/8
YAG38L2NTCFXTZ		550 kcmil G,H,I DLO 535				1/2	0.56	1.25	1.45	1.82	5.40	1-3/4	0.63	0.27	
YAG40L2NNTFXTZ	—	650 kcmil G DLO 646	400	Black	24	1/2	0.56	1.35	1.42	1.63	5.43	1-3/4	0.63	0.30	1-5/16
YAG44L2TC38FXTZ	—	750 kcmil G,H	500	Yellow	L115	3/8	0.40	1.50	1.65	2.18	4.80	1.00	0.50	0.33	1-5/8
YAG44L2NTCFXTZ		750 kcmil G,H DLO 777				1/2	0.56	1.50	1.65	2.18	5.80	1-3/4	0.63	0.33	

◆ For applications greater than 2000 volts consult cable manufacturer for voltage stress relief instructions

Notes: All dimensions shown are for reference only.

Field bending straight lugs to achieve an angular connection will void UL Listing / CSA Certifications and BURNDY will not be liable for the connection.

TYPES YA-L-4TC, YAV-L-4TC-FX

HYLUG™

Uninsulated Copper Compression Terminal
UL Listed 90° C, Up to 35 kV ♦



Features & Benefits

- Inspection window allows for visual verification that the wire has been fully inserted prior to crimping the lug
- Split feature in the tongue/tang is used when connecting two separate terminal blocks for the same phase; the slot provides the needed equipment gap while allowing the proper mounting hole alignment
- Barrel is designed with an internal chamfer at the wire entry to ensure smooth insertion of the wire, preventing possible damaging of the wire strands during installation
- Short/standard length barrel is recommended for installations with limited space requirements
- Two hole tongue/tang is recommended when space permits as the 2-hole feature minimizes the terminations from loosening or rotating under vibration, movement or heat cycling
- 45° and 90° angular lugs are available; please contact Customer Service
- Electro-tin plated unless specified to reduce galvanic corrosion (bimetallic) and resist corrosive elements
- Connectors are clearly marked with stamping and barrel color coding
- BURNDY certifies its products using the BURNDY Engineered System and select other crimp tool manufacturers in accordance with one or more of the UL categories in order to obtain a UL Listing
- Terminals and splices accommodating code wire: Accommodates Code Class B (Concentric, Compressed, Compact) and Class C wire

NOTE: Field bending straight lugs to achieve an angular connection will void UL Listing / CSA Certifications and BURNDY will not be liable for the connection.

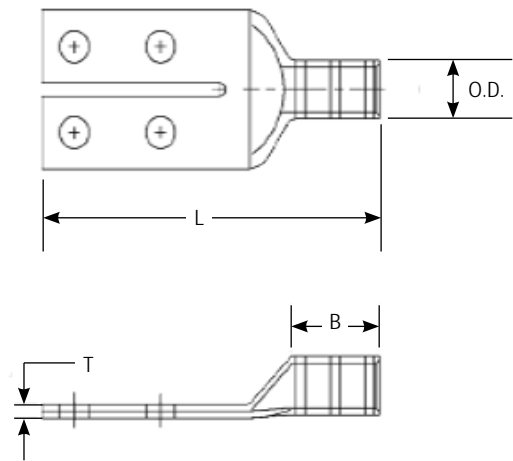

Catalog Number	Wire Size	Stud Hole Size	Stud Hole Spacing	Tongue Width	Figure Dimensions			Installation Tooling					Wire Strip Length	
					(B)	(T)	(L)	Dieless (# of crimps)	MD6, OUR840, MD734R	500 Series	35, 750, 46** Series	Color Code		Die Index
YAV2CL4TC14FXG1	#2 AWG G,H,I,K,M DLO (150/24) #2 AWG	1/4	0.62	1.38	0.62	0.11	2.84	MY2911 (1) 644Series (1) 444 Series (1)	X2CRT (1) W2CRT (1) W2CVT (1)	X2CRT (1) W2CRT (1) W2CVT (1)	U2CRT (1)	Brown	10	11/16
YAV25L4TC14FXG1	1/0 AWG G,H,I,K,M DLO (275/24) 1/0 AWG	1/4	0.62	1.38	0.69	0.21	2.90	MY29 Series (1) 644 Series (1) 444 Series (1)	X25RT (1) W25RT (1) W25VT (1)	X25RT (1) W25RT (1) W25VT (1)	U25RT (1)	Pink	12	13/16
YAV26L4TC14FXG1	2/0 AWG G,H,I,K,M DLO (325/24) 2/0 AWG	1/4	0.62	1.38	0.81	0.21	3.07		X26RT (2) W26RT (2) W26VT (2)	X26RT (2) W26RT (2) W26VT (2)	U26RT (1)	Black	13	1-1/16
YAV27L4TC14FXG1	3/0 AWG G,H,I,K,M DLO (450/24) 3/0 AWG	1/4	0.62	1.38	1.00	0.21	3.30		X27RT (3) W27RT (2) W27VT (2)	X27RT (3) W27RT (2) W27VT (2)	U27RT (1)	Orange	14	1-1/16
YAV28L4TC14FXG1	4/0 AWG G,H,I,K,M DLO (550/24) 4/0 AWG	1/4	0.62	1.38	1.00	0.21	3.38		X28RT (3) W28RT (2) W28VT (2)	X28RT (3) W28RT (2) W28VT (2)	U28RT (1)	Purple	15	11/16

Compression Connections

Copper Compression — Terminal — Flex — Split Tongue
Standard Barrel — with Inspection Window

TYPES YA-L-4TC, YAV-L-4TC-FX (Continued)



NOTE: Field bending straight lugs to achieve an angular connection will void UL Listing / CSA Certifications and BURNDY will not be liable for the connection.

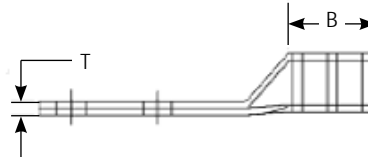
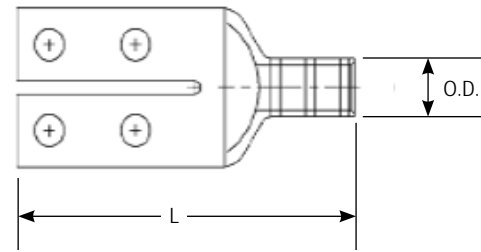

Catalog Number	Wire Size	Stud Hole Size	Stud Hole Spacing	Tongue Width	Figure Dimensions			Installation Tooling					Wire Strip Length	
					(B)	(T)	(L)	Dieless (# of crimps)	MD6, OUR840, MD734R	500 Series	35, 750, 46** Series	Color Code		Die Index
YAZ254TCG1	1/0 AWG	1/4	0.62	1.38	1.38	0.11	3.55	MY29 Series (1) 644 Series (1) 444 Series (1)	X25RT (1)	X25RT (1)	U25RT (2) U2CABT (2)	Pink	12 or 348	1-7/16
YAZ254TC38E1G1		3/8	1.00	1.63	1.38	0.11	3.93		W25RT (1)	W25RT (1)				
YAZ264TC38E1G1		3/8	1.00	1.63	1.50	0.21	4.09		W25VT (1)	W25VT (1)				
YAZ264TCG1	2/0 AWG	3/8	1.00	1.63	1.50	0.21	4.09		X26RT (2)	X26RT (2)	U26RT (2) U26D1 (2)	Black	13	1-9/16
YAZ284TCG1		1/4	0.62	1.38	1.50	0.21	3.71		W26RT (2)	W26RT (2)				
YAZ294TCG1		1/4	0.62	1.38	1.62	0.21	3.91		W26VT (2)	W26VT (2)				
YAZ284TCG1	4/0 AWG	1/4	0.62	1.38	1.62	0.21	3.91		X28RT (3)	X28RT (3)	U28RT (1)	Purple	15	1-11/16
YAZ294TCG1		1/4	0.62	1.38	1.62	0.21	3.94		W28RT (2)	W28RT (2)				
YAZ314TCG1		1/4	0.62	1.38	2.00	0.21	4.39		W28VT (2)	W28VT (2)				
YAZ294TCG1	250 kcmil	1/4	0.62	1.38	1.62	0.21	3.94		X29RT (4)	X29RT (4)	U29RT (2) U29D1 (2)	Yellow	16	1-11/16
YAZ314TCG1								1/4	0.62	1.38				
YAZ314TCG1	350 kcmil	1/4	0.62	1.38	2.00	0.21	4.39	W31RT (2)	W31RT (2)	U31D1 (2) U31RT (2) U29ART (2)	Red	18 or 324	2-1/16	
YAZ314TCG1								1/4	0.62					1.38

** Use PUADP1 adapter with U dies in 46 Series of tools

Catalog Number Type	Wire Size	Color Code and Die Index Number	Mechanical & Ratchet Dies Required (# Crimps)		Mechanical & Ratchet Dedicated Die Tools # Crimps				
	Conductor (CU Only)		MD6 and MD7 Series <small>*Due to handle force not recommended</small>	OUR840 <small>*Due to handle force not recommended</small>	MY28 and MY29 Series	MRC840	MRE1022B Y8MRB1 Y10D Y1022	Y122CMR	Y1MRTC
YA-10	#14 - #10 AWG B,C,I,K,M DLO	—	—	—	—	—	1 CRIMP	1 CRIMP	—
YA-8C-L-FX	#8 AWG B,C,G,H,I,K,M DLO #6 Sol / #8 Sol	RED 49	X8CRT (1) W8CRT (1) W8CVT (1)	X8CRT (1) W8CRT (1) W8CVT (1)	1 CRIMP	1 CRIMP	—	1 CRIMP	1 CRIMP
YA-6C-L-FX	#6 AWG Sol B,C,G,H,I,K,M DLO	BLUE 7	X5CRT (1) W5CRT (1) W5CVT (1)	X5CRT (1)	1 CRIMP	1 CRIMP	—	1 CRIMP	1 CRIMP
YA-4C-L-FX	#4 AWG B,C,G,H,I,K,M DLO	GRAY 8	X4CRT (1) W4CRT (1) W4CVT (1)	X4CRT (1)	1 CRIMP	1 CRIMP	—	2 CRIMPS	2 CRIMPS
YA-3C-L-FX	#3 AWG B,C,G,H,I,K,M DLO	WHITE 9	W3CRT (1)	—	1 CRIMP	1 CRIMP	—	2 CRIMPS	2 CRIMPS
YA-2C-L-FX	#2 AWG B,C,G,H,I,K,M DLO	BROWN 10	X2CRT (1) W2CRT (1) W2CVT (1)	X2CRT (1)	1 CRIMP	1 CRIMP	—	2 CRIMPS	2 CRIMPS
YA-1C-L-FX	#1 AWG B,C,G,H,I,K,M DLO	GREEN 11	X1CRT1 (1) W1CRT1 (1) W1CVT (1)	X1CRT1 (1)	1 CRIMP	1 CRIMP	—	—	—
YA-25-L-FX	1/0 AWG B,C,G,H,I,K,M DLO	PINK 12	X25RT (2) W25RT (2) W25VT (2)	X25RT (2) W25RT (2)* W25VT (2)*	1 CRIMP	2 CRIMPS	—	—	—
YA-26-L-FX	2/0 AWG B,C,G,H,I,K,M DLO	BLACK 13	X26RT (2) W26RT (2) W26VT (2)	X26RT (2) W26RT (2)* W26VT (2)*	1 CRIMP	2 CRIMPS	—	—	—
YA-27-L-FX	3/0 AWG B,C,G,H,I,K,M DLO	ORANGE 14	X27RT (3) W27RT (2) W27VT (2)	X27RT (3) W27RT (2)* W27VT (2)*	1 CRIMP	2 CRIMPS	—	—	—
YA-28-L-FX	4/0 AWG B,C,G,H,I,K,M DLO	PURPLE 15	X28RT (3) W28RT (2) W28VT (2)	X28RT (3) W28RT (2)* W28VT (2)*	1 CRIMP	2 CRIMPS	—	—	—
YA-29-L-FX	250 kcmil B,C 4/0 AWG G,H,I,K,M DLO	YELLOW 16	X29RT (4) W29RT (2) W29VT (2)	X29RT (4) W29RT (2)* W29VT (2)*	1 CRIMP	—	—	—	—
YA-30-L-FX	250 kcmil G, H	YELLOW 16	X29RT (4) W29RT (2)* W29VT (2)	X29RT (4) W29RT (2)* W29VT (2)*	—	—	—	—	—
YA-31-L-FX	250 kcmil I,K,M 262 DLO	WHITE 17	W30RT (2)* W30VT (2)	—	—	—	—	—	—
YA-32-L-FX	300 kcmil G,H,I,K,M 313 DLO	RED 18	W31RT (2)* W31VT (2)	—	—	—	—	—	—
YA-34-L-FX	350 kcmil G,H,I,K,M 373 DLO	BLUE 19	W32RT (2)* W32VT (2)	—	—	—	—	—	—

Compression Connections

Copper Flex Standard Barrel Terminal Tooling Table
Hydraulic Requiring Dies and Dieless

Catalog Number Type	Wire Size	Color Code and Die Index Number	Hydraulic Tools - Dies Required (# Crimps)					Hydraulic Tools - Dieless	
	Conductor (CU Only)		MD6, 600, 500 Series	750, 35 Series	45 Series Use PT6515 with U Dies	46 Series Use PUADP1 with U Dies	60 Series	81K 4PC Series	644 444 Series
YA-10	#14 - #10 AWG B,C,I,K,M DLO	—	—	—	—	—	—	—	—
YA-8C-L-FX	#8 AWG B,C,G,H,I,K,M DLO #6 Sol / #8 Sol	RED 49	X8CRT (1) W8CRT (1) W8CVT (1)	U8CRT (1)	U8CRT (1)	U8CRT (1)	—	1 CRIMP	—
YA-6C-L-FX	#6 AWG Sol B,C,G,H,I,K,M DLO	BLUE 7	X5CRT (1) W5CRT (1) W5CVT (1)	U5CRT (1)	U5CRT (1)	U5CRT (1)	—	1 CRIMP	—
YA-4C-L-FX	#4 AWG B,C,G,H,I,K,M DLO	GRAY 8	X4CRT (1) W4CRT (1) W4CVT (1)	U4CRT (1)	U4CRT (1)	U4CRT (1)	—	1 CRIMP	—
YA-3C-L-FX	#3 AWG B,C,G,H,I,K,M DLO	WHITE 9	W3CRT (1)	U3CRT (1)	U3CRT (1)	U3CRT (1)	—	1 CRIMP	—
YA-2C-L-FX	#2 AWG B,C,G,H,I,K,M DLO	BROWN 10	X2CRT (1) W2CRT (1) W2CVT (1)	U2CRT (1)	U2CRT (1)	U2CRT (1)	—	1 CRIMP	1 CRIMP
YA-1C-L-FX	#1 AWG B,C,G,H,I,K,M DLO	GREEN 11	X1CRT1 (1) W1CRT1 (1) W1CVT (1)	U1CRT1 (1)	U1CRT1 (1)	U1CRT1 (1)	—	1 CRIMP	1 CRIMP
YA-25-L-FX	1/0 AWG B,C,G,H,I,K,M DLO	PINK 12	X25RT (2) W25RT (2) W25VT (2)	U25RT (1)	U25RT (1)	U25RT (1)	—	1 CRIMP	1 CRIMP
YA-26-L-FX	2/0 AWG B,C,G,H,I,K,M DLO	BLACK 13	X26RT (2) W26RT (2) W26VT (2)	U26RT (1)	U26RT (1)	U26RT (1)	—	1 CRIMP	1 CRIMP
YA-27-L-FX	3/0 AWG B,C,G,H,I,K,M DLO	ORANGE 14	X27RT (3) W27RT (2) W27VT (2)	U27RT (1)	U27RT (1)	U27RT (1)	—	1 CRIMP	1 CRIMP
YA-28-L-FX	4/0 AWG B,C,G,H,I,K,M DLO	PURPLE 15	X28RT (3) W28RT (2) W28VT (2)	U28RT (1)	U28RT (1)	U28RT (1)	L28RT (1)	1 CRIMP	1 CRIMP
YA-29-L-FX	250 kcmil B,C 4/0 AWG G,H,I,K,M DLO	YELLOW 16	X29RT (4) W29RT (2) W29VT (2)	U29RT (1)	U29RT (1)	U29RT (1)	L29RT (1)	1 CRIMP	1 CRIMP
YA-30-L-FX	250 kcmil G, H	YELLOW 16	X29RT (4) W29RT (2) W29VT (2)	U29RT (1)	U29RT (1)	U29RT (1)	L29RT (1)	1 CRIMP	1 CRIMP
YA-31-L-FX	250 kcmil I,K,M 262 DLO	WHITE 17	W30RT (2) W30VT (2)	U30RT (2)	U30RT (2)	U30RT (2)	L30RT (1)	1 CRIMP	1 CRIMP
YA-32-L-FX	300 kcmil G,H,I,K,M 313 DLO	RED 18	W31RT (2) W31VT (2)	U31RT (2)	U31RT (2)	U31RT (2)	L31RT (1)	1 CRIMP	1 CRIMP

Catalog Number Type	Wire Size	Color Code and Die Index Number	Hydraulic Tools - Dies Required (# Crimps)					Hydraulic Tools - Dieless	
	Conductor (CU Only)		MD6, 600, 500 Series	750, 35 Series	45 Series <i>Use PT6515 with U Dies</i>	46 Series <i>Use PUADP1 with U Dies</i>	60 Series	81K 4PC Series	644 444 Series
YA-34-L-FX	350 kcmil G,H,I,K,M 373 DLO	BLUE 19	W32RT (2) W32VT (2)	U32RT (2)	U32RT (2)	U32RT (2)	L32RT (1)	1 CRIMP	1 CRIMP
YA-36-L-FX	500 kcmil G,H 444 DLO	BROWN 20	—	U34RT (2)	U34RT (2)	U34RT (2)	L34RT (1)	1 CRIMP	1 CRIMP
YA-38-L-FX	500 kcmil H,I,K 550 kcmil G,H,I 535 DLO	PINK L99	—	U38XRT (2)	U38XRT (2)	U38XRT (2)	—	1 CRIMP	1 CRIMP
YA-39-L-FX	600 kcmil G,H,I,K DLO	PINK 400	—	U38RT (2)	U38RT (2)	U38RT (2)	—	2 OVERLAPPING CRIMPS	1 CRIMP
YA-40-L-FX	650 kcmil G 646 DLO	BLACK 24	—	U39RT (2)	U39RT (2)	U39RT (2)	L39RT (1)	2 OVERLAPPING CRIMPS	1 CRIMP
YA-44-L-FX	750 kcmil G,H,I 777 DLO	YELLOW L115	—	U44XRT (2)	U44XRT (2)	U44XRT (2) P44XRT (2)	—	2 OVERLAPPING CRIMPS	1 CRIMP
YA-45-L-FX	929 kcmil DLO	WHITE 27	—	—	S44RT (2)	P44RT (2)	L44RT (1)	—	—

Installation Instructions

Installation instructions help the installer understand proper wire preparation, proper insertion requirements, crimp zone location, individual crimp location, crimp order and crimp direction, to ensure safe and reliable wire connections. UL Listing and CSA Certification are only valid when using the BURNDY® Engineered System and following BURNDY Installation Instructions.

Copper Flex Standard Barrel Terminal Installation Steps:

1. Select the appropriate connector based on:
 - Wire Material
 - Wire Construction
 - Wire Size
2. Strip the insulation to the appropriate wire strip length, based on the table's Wire Strip Length recommendation for the selected connector. Due to tolerances in the connector, wire strip length, and insulation stripping tools, this range may be 0" - 1/4". The exposed wire, also known as a "shiner", has no performance impact on the connection and there is no wire exposure requirement by BURNDY.
3. As a best practice, wire brush the bare conductor to remove any oxides. DO NOT wire brush tin-plated connectors.
4. Insert the conductor into the barrel for the full length. If the connector has an inspection window, the conductor end can easily be seen to verify full wire insertion.
5. Apply the proper number of crimps specified by the appropriate illustration.
6. *Some catalog numbers require overlapping crimps when using the 81K or 4PC Series of installation tools. Please refer to the overlapping crimp image that is applicable based on the number of crimps required. Overlap each consecutive crimp so that the completed installation of all overlapping crimps covers the entire crimp zone.
7. Once all crimps have been completed, the connection can be easily inspected for proper installation.

NOTE: Illustrations show black bands however this is just a representation of the crimp zones. See individual connector for actual crimp band color.

Example: YAV28LNT38FX

Go to the YA-28-L-FX Catalog Number Designation for 4/0 AWG G,H,I,K,M or DLO.
 Confirm the Tool (750 Series for this example).
 Confirm the Die Set Needed (U28RT for this example)
 Confirm the Number of Crimps Necessary (1 for this example).
 For proper crimp placement refer to the image on this page corresponding to the number of crimps.



CATALOG NUMBER DESIGNATIONS		
YA-8C-L-FX	YA-6C-L-FX	YA-4C-L-FX
YA-3C-L-FX	YA-2C-L-FX	YA-1C-L-FX



CATALOG NUMBER DESIGNATIONS			
YA-25-L-FX	YA-26-L-FX	YA-27-L-FX	YA-28-L-FX
YA-29-L-FX	YA-30-L-FX	YA-31-L-FX	YA-32-L-FX
YA-34-L-FX	YA-36-L-FX	YA-38-L-FX	YA-39-L-FX*
YA-40-L-FX*	YA-44-L-FX*	YA-45-L-FX	

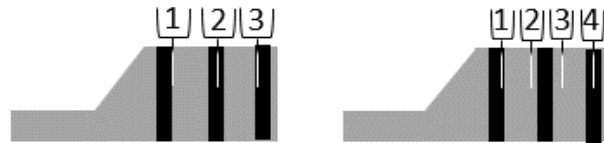

2 Overlapping

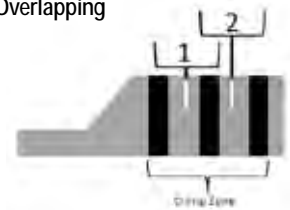

TYPES YAZ, YAZV

HYLUG™

Uninsulated Copper Compression Terminal
UL Listed 90° C, Up to 35 kV ◆

45° and 90° angles available. Please contact Customer Service to order:
1-800-346-4175

Features & Benefits

- Inspection windows allows for visual verification that the wire has been fully inserted prior to crimping the lug
- Barrel is designed with an internal chamfer at the wire entry to ensure smooth insertion of the wire, preventing possible damaging of the wire strands during insertion
- Long barrel allows for an increased number of crimps which will increase the mechanical strength of the connection
- 45° and 90° angular lugs are available; please contact Customer Service
- Electro-tin plated unless otherwise specified to reduce galvanic corrosion (bimetallic) and resist corrosive elements
- Connectors are clearly marked with stamping and barrel color coding
- Connectors accommodating wire sizes #10 - 250 kcmil accommodate both Flex and Code Wire. See Tables on each page for specific details
- Tables in this section identify flex wire as the nominal flex wire size followed by the wire classes and DLO wire size and stranding. For Class Wire Strand counts, see the table at the beginning of this section.
- BURNDY certifies its products using the BURNDY Engineered System and select other crimp tool manufacturers in accordance with one or more of the UL categories in order to obtain a UL Listing

Accessories

- Hardware - Section F
- PENETROX™ Oxide Inhibitor - Section F
- Heat and Cold Shrink Tubing - Section D
- WIREMIKE™ Wire Micrometer - Section F
- Wire Management (Cable Ties) - Section G

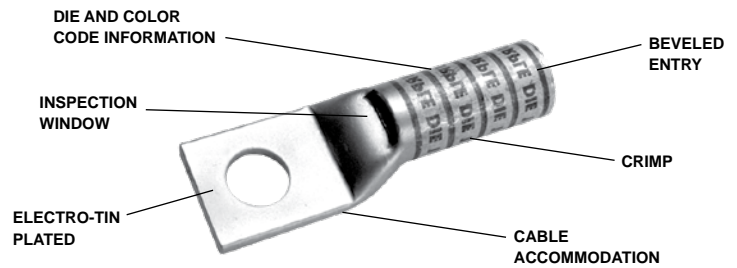

NOTE: Field bending straight lugs to achieve an angular connection will void UL Listing / CSA Certifications and BURNDY will not be liable for the connection.

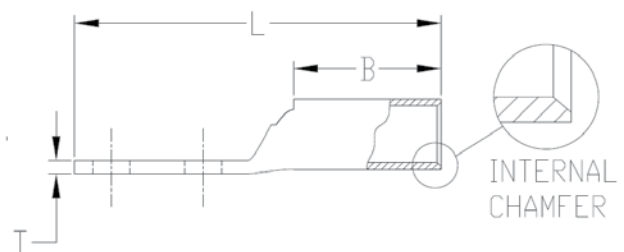
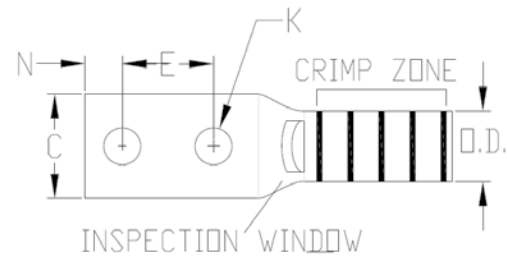

Compression Connections

Copper Compression — Terminal — Flex — One Hole
Long Barrel — with Inspection Window

TYPES YAZ, YAZV (Continued)

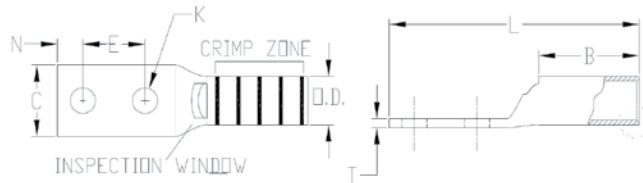

▲ See Copper Flex Long Barrel Terminal Tooling Tables in this section for complete tool and die listing information.

Catalog Number	Conductor			Color Code	Die Index	Stud Size	Figure Dimensions								Wire Strip Length
	Code	Flex	Metric MM ² ***				Stud Hole Diameter (K)	Outside Diameter (OD)	Barrel Length (B)	Pad Width (C)	Overall Length (L)	Hole Spacing (E) & (F)	Hole Offset (N)	Pad Thickness (T)	
YAZ8CTC10	#8 AWG	#8 AWG	10	Red	49	#10	0.21	0.27	0.75	.41"	1.43	—	0.25	0.08	13/16
YAZ8CTC14	#6 Sol	G,H,I,K,M				1/4	0.27	0.27	0.75	.44"	1.56	—	0.31	0.08	
YAZ8CTC38	#8 Sol	DLO				3/8	0.40	0.27	0.75	.58"	1.75	—	0.41	0.06	
YAZV6CTC14FX	#6 AWG	#6 AWG	16	Blue	7 or 374	1/4	0.27	0.31	0.75	.48"	1.59	—	0.31	0.08	13/16
YAZV6CTC38FX						3/8	0.41	0.31	0.75	.58"	1.77	—	0.41	0.06	
YAZV4CTC14FX	#4 AWG	#4 AWG	—	Gray	8 or 346	1/4	0.27	0.38	1.25	.55"	2.19	—	0.31	0.09	1-5/16
YAZV4CTC38FX						3/8	0.40	0.38	1.25	.58"	2.42	—	0.41	0.08	
YAZV2CTC14FX	#2 AWG	#2 AWG	35	Brown	10	1/4	0.27	0.46	1.38	.68"	2.37	—	0.31	0.10	1-7/16
YAZV2CTC38FX						3/8	0.40	0.46	1.38	.68"	2.56	—	0.41	0.10	
YAZV2CTC12FX						1/2	0.52	0.46	1.38	.83"	2.87	—	0.53	0.09	
YAZV1CTC14FX	#1 AWG	#1 AWG	—	Green	11 or 375	1/4	0.27	0.51	1.38	.75"	2.40	—	0.31	0.12	1-7/16
YAZV1CTC516FX						5/16	0.33	0.51	1.38	.75"	2.46	—	0.34	0.12	
YAZV1CTC38FX						3/8	0.40	0.51	1.38	.75"	2.59	—	0.41	0.12	
YAZV25TC14FX	1/0 AWG	1/0 AWG	50	Pink	12 or 348	1/4	0.27	0.56	1.50	.83"	2.56	—	0.31	0.12	1-9/16
YAZV25TC38FX						3/8	0.40	0.56	1.50	.83"	2.75	—	0.41	0.12	
YAZV25TC12FX						1/2	0.52	0.56	1.50	.83"	3.00	—	0.53	0.12	
YAZV26TC14FX	2/0 AWG	2/0 AWG	70	Black	13	1/4	0.27	0.63	1.50	.93"	2.61	—	0.31	0.13	1-9/16
YAZV26TC38FX						3/8	0.40	0.63	1.50	.93"	2.80	—	0.41	0.13	
YAZV26TC12FX						1/2	0.52	0.63	1.50	.93"	3.05	—	0.53	0.13	
YAZV27TC38FX	3/0 AWG	3/0 AWG	95	Orange	14	3/8	0.40	0.70	1.50	1.03"	2.84	—	0.41	0.14	1-9/16
YAZV28NT38FX	4/0 AWG	4/0 AWG	120	Purple	15	3/8	0.40	0.77	1.62	.94"	3.01	—	0.41	0.14	1-11/16
YAZV28TC38FX						3/8	0.40	0.77	1.62	1.14"	3.01	—	0.41	0.14	
YAZV28TC12FX						1/2	0.52	0.77	1.62	1.14"	3.26	—	0.53	0.14	
YAZV29NT516FX	250 kcmil	4/0 AWG	—	Yellow	16	5/16	0.33	0.80	2.00	.96"	3.27	—	0.34	0.16	2-1/16
YAZ30TC38FX	—	250 kcmil	—	Yellow	16	3/8	0.40	0.81	2.00	1.20"	3.41	—	0.41	0.16	2-1/16
YAZ31TC38FX	—	250 kcmil	150	White	17 or 298	3/8	0.40	0.88	2.00	1.28"	3.44	—	0.41	0.18	2-1/16

** The MM² conductor size referenced here is for both Class 2 and Class 5 conductor

*** The MM² conductor sizes listed are the recommendations for Class 5 conductor

◆ For applications greater than 2000 volts consult cable manufacturer for voltage stress relief instructions

Notes: All dimensions shown are for reference only.

Field bending straight lugs to achieve an angular connection will void UL Listing / CSA Certifications and BURNDY will not be liable for the connection.

TYPES YAZ, YAZV (Continued)

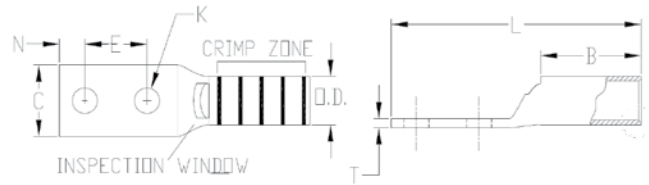

▲ See Copper Flex Long Barrel Terminal Tooling Tables in this section for complete tool and die listing information.

Catalog Number	Conductor			Color Code	Die Index	Stud Size	Figure Dimensions								Wire Strip Length
	Code	Flex	Metric MM ² ***				Stud Hole Diameter (K)	Outside Diameter (OD)	Barrel Length (B)	Pad Width (C)	Overall Length (L)	Hole Spacing (E) & (F)	Hole Offset (N)	Pad Thickness (T)	
YAZ32TC38FX	—	300 kcmil G,H,I,K,M, 313 DLO	185	Red	18 or 324	3/8	0.40	0.95	2.12	1.55"	3.61	—	0.41	0.19	2-3/16
YAZ34NT38FX	—	350 kcmil G,H,I,K,M, 373 DLO	240	Blue	19	3/8	0.40	1.06	2.25	.96"	3.84	—	0.41	0.23	2-5/16
YAZ34TC38FX						3/8	0.52	1.06	2.25	1.52"	3.84	—	0.53	0.23	
YAZ34TC12FX						1/2	0.40	1.06	2.25	1.52"	4.09	—	0.41	0.23	
YAZ36TC38FX	—	500 kcmil G,H 444 DLO	—	Brown	20 or 299	3/8	0.40	1.19	2.69	1.72"	4.54	—	0.41	0.26	2-3/4
YAZ38NT38FX	—	500 kcmil H,I,K 550 kcmil G,H,I 535 DLO	300	Pink	L99	3/8	0.40	1.25	2.81	1.63"	4.71	—	0.50	0.27	2-7/8
YAZ38TC38FX						3/8	0.40	1.25	2.81	1.81"	4.71	—	0.50	0.27	
YAZ38NT12FX						1/2	0.52	1.25	2.81	1.63"	4.77	—	0.53	0.27	
YAZ38TC12FX						1/2	0.52	1.25	2.81	1.81"	4.77	—	0.53	0.27	

** The MM² conductor size referenced here is for both Class 2 and Class 5 conductor

*** The MM² conductor sizes listed are the recommendations for Class 5 conductor

◆ For applications greater than 2000 volts consult cable manufacturer for voltage stress relief instructions

Notes: All dimensions shown are for reference only.

Field bending straight lugs to achieve an angular connection will void UL Listing / CSA Certifications and BURNDY will not be liable for the connection.

Compression Connections

Copper Compression — Terminal — Flex — One Hole
Long Barrel, Belled End — No Inspection Window

TYPES YA-TC-FXB, YAV-TC-FXB

HYLUG™

Uninsulated Copper Compression Terminal
UL Listed 90° C, Up to 35 kV ♦

45° and 90° angles available. Please contact Customer Service to order:
1-800-346-4175

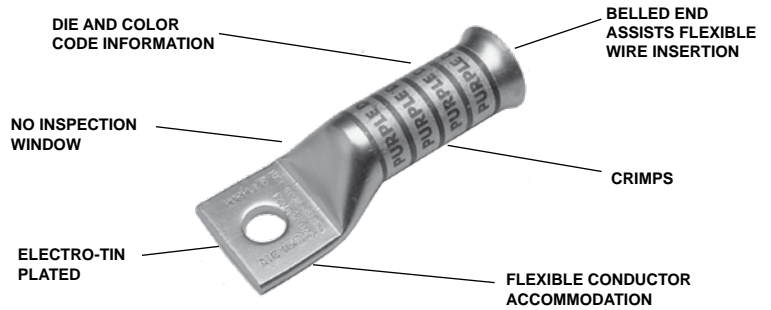

Features & Benefits

- No inspection window is ideal for more corrosive environments as the barrel transition is not open
- Barrel is designed with a “belled” end opening at the wire entry, to ensure smooth insertion of highly flexible stranded wire, preventing possible damaging of the wire strands during insertion
- Long barrel allows for an increased number of crimps which will increase the mechanical strength of the connection
- 45° and 90° angular lugs are available; please contact Customer Service
- Electro-tin plated unless otherwise specified to reduce galvanic corrosion (bimetallic) and resist corrosive elements
- Connectors are clearly marked with stamping and barrel color coding
- Connectors accommodating wire sizes #10 - 250 kcmil accommodate both Flex and Code Wire. See Tables on each page for specific details
- Tables in this section identify flex wire as the nominal flex wire size followed by the wire classes and DLO wire size and stranding. For Class Wire Strand counts, see the table at the beginning of this section.
- BURNDY certifies its products using the BURNDY Engineered System and select other crimp tool manufacturers in accordance with one or more of the UL categories in order to obtain a UL Listing



NOTE: Field bending straight lugs to achieve an angular connection will void UL Listing / CSA Certifications and BURNDY will not be liable for the connection.

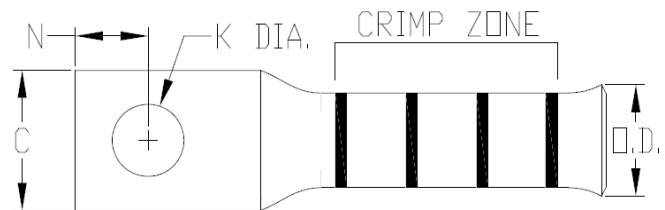

Accessories

- Hardware - Section F
- PENETROX™ Oxide Inhibitor - Section F
- Heat and Cold Shrink Tubing - Section D
- WIREMIKE™ Wire Micrometer - Section F
- Wire Management (Cable Ties) - Section G

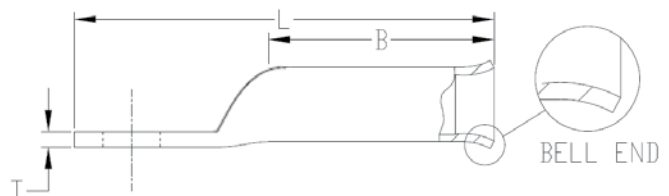

TYPES YA-TC-FXB, YAV-TC-FXB (Continued)

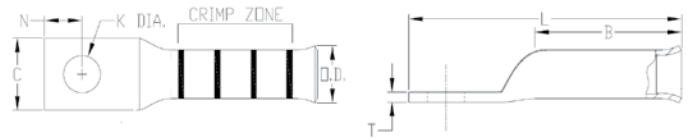

▲ See Copper Flex Long Barrel Terminal Tooling Tables in this section for complete tool and die listing information.

Catalog Number	Conductor			Color Code	Die Index	Stud Size	Figure Dimensions								Wire Strip Length
	Code	Flex	Metric MM ² ***				Stud Hole Diameter (K)	Outside Diameter (OD)	Barrel Length (B)	Pad Width (C)	Overall Length (L)	Hole Spacing (E) & (F)	Hole Offset (N)	Pad Thickness (T)	
YA8CTC14FXB	#8 AWG #6 Sol #8 Sol	#8 AWG G,H,I,K,M DLO	** 10	Red	49	1/4	0.27	0.27	0.90	0.44	1.78	—	0.31	0.08	1
YAV6CTC10FXB	#6 AWG	#6 AWG G,H,I,K,M, DLO	** 16	Blue	7	#8-#10	0.21	0.31	1.22	0.48	2.00	—	0.25	0.08	1-5/16
YAV6CTC14FXB						1/4	0.27	0.31	1.22	0.48	2.12	—	0.31	0.08	
YA5CTC14FXB	#5 AWG	#5 AWG G,H,I,K,M, DLO	—	BLue	7	1/4	0.27	0.30	1.22	0.44	2.12	—	0.31	0.07	
YAV4CTC10FXB	#4 AWG	#4 AWG G,H,I,K,M, DLO	—	Gray	8	#8-#10	0.21	0.38	1.22	0.55	2.05	—	0.25	0.09	1-5/16
YAV4CTC14FXB						1/4	0.27	0.38	1.22	0.55	2.17	—	0.31	0.09	
YAV4CTC516FXB						5/16	0.33	0.38	1.22	0.55	2.24	—	0.34	0.09	
YAV2CTC10FXB	#2 AWG	#2 AWG G,H,I,K,M, DLO	35	Brown	10	#8-#10	0.21	0.46	1.35	0.68	2.24	—	0.25	0.10	1-7/16
YAV2CTC516FXB						5/16	0.33	0.46	1.35	0.68	2.43	—	0.34	0.10	
YAV1CTC10FXB	#1 AWG	#1 AWG G,H,I,K,M, DLO	—	Green	11	#8-#10	0.21	0.51	1.50	0.75	2.41	—	0.25	0.12	1-9/16
YAV1CTC516FXB						5/16	0.33	0.51	1.50	0.75	2.60	—	0.34	0.12	
YAV25TC10FXB	1/0 AWG	1/0 AWG G,H,I,K,M, DLO	50	Pink	12	#8-#10	0.21	0.56	1.50	0.83	2.45	—	0.25	0.12	1-9/16
YAV25TC516FXB						5/16	0.33	0.56	1.50	0.83	2.64	—	0.34	0.12	
YAV25TC38FXB						3/8	0.40	0.56	1.50	0.83	2.77	—	0.41	0.12	
YAV25TC12FXB						1/2	0.56	0.56	1.50	0.83	3.20	—	0.62	0.12	
YAV26TC38FXB	2/0 AWG	2/0 AWG G,H,I,K,M, DLO	70	Black	13	3/8	0.40	0.63	1.63	0.93	2.95	—	0.41	0.13	1-13/16
YAV26TC12FXB						1/2	0.56	0.63	1.63	0.93	3.39	—	0.62	0.13	
YAV27TC12FXB	3/0 AWG	3/0 AWG G,H,I,K,M, DLO	95	Orange	14	1/2	0.56	0.70	1.64	1.04	3.44	—	0.62	0.14	1-13/16
YAV28TC38FXB	4/0 AWG	4/0 AWG G,H,I,K,M, DLO	—	Purple	15	3/8	0.40	0.77	1.77	1.14	3.19	—	0.41	0.14	1-7/8
YAV28TC12FXB						1/2	0.56	0.77	1.77	1.14	3.63	—	0.62	0.14	
YA30TC12FXB	—	250 kcmil G,H	—	Yellow	16	1/2	0.56	0.81	4.04	1.20	4.04	—	0.62	0.16	2-1/4
YA31TC12FXB	—	250 kcmil I,K,M, 262 DLO	150	White	17	1/2	0.56	0.88	2.18	1.29	4.09	—	0.62	0.18	2-1/4
YA32TC12FXB	—	300 kcmil G,H,I,K,M, 313 DLO	185	Red	18	1/2	0.56	0.95	2.32	1.40	4.28	—	0.62	0.19	2-1/4

** The MM² conductor size referenced here is for both Class 2 and Class 5 conductor

*** The MM² conductor sizes listed are the recommendations for Class 5 conductor

♦ For applications greater than 2000 volts consult cable manufacturer for voltage stress relief instructions

Notes: All dimensions shown are for reference only.

Field bending straight lugs to achieve an angular connection will void UL Listing / CSA Certifications and BURNDY will not be liable for the connection.

Compression Connections

Copper Compression — Terminal — Flex — One Hole
Long Barrel, Belled End — No Inspection Window

TYPES YA-TC-FXB, YAV-TC-FXB (Continued)

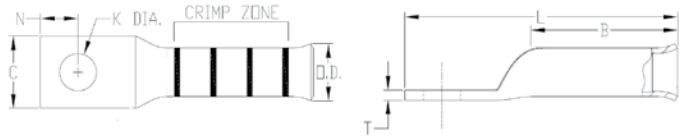

▲ See Copper Flex Long Barrel Terminal Tooling Tables in this section for complete tool and die listing information.

Catalog Number	Conductor			Color Code	Die Index	Stud Size	Figure Dimensions								Wire Strip Length
	Code	Flex	Metric MM ² ***				Stud Hole Diameter (K)	Outside Diameter (OD)	Barrel Length (B)	Pad Width (C)	Overall Length (L)	Hole Spacing (E & F)	Hole Offset (N)	Pad Thickness (T)	
YA34TC12FXB	—	350 kcmil G,H,I,K,M, 373 DLO	240	Blue	19	1/2	0.56	1.06	2.48	1.55	4.54	—	0.62	0.23	2-9/16
YA36TC12FXB	—	500 kcmil G,H 444 DLO	—	Brown	20	1/2	0.56	1.18	2.95	1.73	5.09	—	0.62	0.26	3-1/16
YA36TC58FXB						5/8	0.69	1.18	2.95	1.73	5.15	—	0.66	0.26	
YA38TC12FXB	—	500 kcmil H,I,K 550 kcmil G,H,I 535 DLO	300	Pink	L99	1/2	0.53	1.25	3.08	1.84	5.07	—	0.53	0.27	3-1/16
YA38TC58FXB						5/8	0.69	1.25	3.08	1.84	5.32	—	0.66	0.27	
YA40TC58FXB	—	650 kcmil G 646 DLO	400	Black	24	5/8	0.69	1.35	3.24	1.98	5.53	—	0.66	0.30	3-5/16
YA44TC58FXB	—	750 kcmil G,H 777 DLO	500	Yellow	L115	5/8	0.69	1.49	3.33	2.18	5.71	—	0.66	0.32	3-7/16
YA46TC58FXB	—	1000 kcmil G, H 1111 DLO	—	Yellow	29	5/8	0.69	1.84	3.58	2.69	6.19	—	0.66	0.39	3-11/16

** The MM² conductor size referenced here is for both Class 2 and Class 5 conductor

*** The MM² conductor sizes listed are the recommendations for Class 5 conductor

◆ For applications greater than 2000 volts consult cable manufacturer for voltage stress relief instructions

Notes: All dimensions shown are for reference only.

Field bending straight lugs to achieve an angular connection will void UL Listing / CSA Certifications and BURNDY will not be liable for the connection.

TYPE YAZ-FX

HYLUG™

Uninsulated Copper Compression Terminal
UL Listed 90° C, Up to 35 kV ◆

45° and 90° angles available. Please contact Customer Service to order:
1-800-346-4175

Features & Benefits

- Inspection windows allows for visual verification that the wire has been fully inserted prior to crimping the lug
- Barrel is designed with an internal chamfer at the wire entry to ensure smooth insertion of the wire, preventing possible damaging of the wire strands during insertion
- Long barrel allows for an increased number of crimps which will increase the mechanical strength of the connection
- Two hole tongue/tang is recommended when space permits as the 2-hole feature minimizes the terminations from loosening or rotating under vibration, movement, or heat cycling
- 45° and 90° angular lugs are available; please contact Customer Service
- Electro-tin plated unless otherwise specified to reduce galvanic corrosion (bimetallic) and resist corrosive elements
- Connectors are clearly marked with stamping and barrel color coding
- Connectors accommodating wire sizes #10 - 250 kcmil accommodate both Flex and Code Wire. See Tables on each page for specific details
- Tables in this section identify flex wire as the nominal flex wire size followed by the wire classes and DLO wire size and stranding. For Class Wire Strand counts, see the table at the beginning of this section.
- BURNDY certifies its products using the BURNDY Engineered System and select other crimp tool manufacturers in accordance with one or more of the UL categories in order to obtain a UL Listing

Accessories

- Hardware - Section F
- PENETROX™ Oxide Inhibitor - Section F
- Heat and Cold Shrink Tubing - Section D
- WIREMIKE™ Wire Micrometer - Section F
- Wire Management (Cable Ties) - Section G

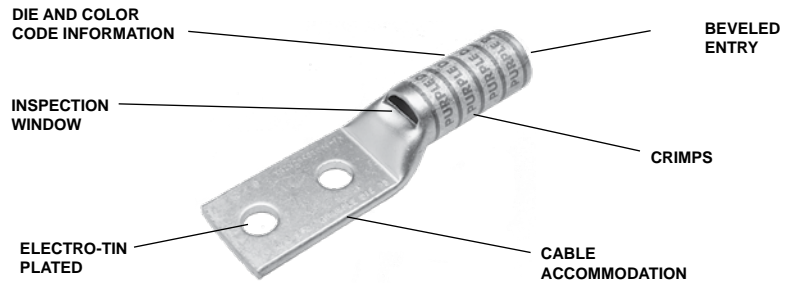

NOTE: Field bending straight lugs to achieve an angular connection will void UL Listing / CSA Certifications and BURNDY will not be liable for the connection.

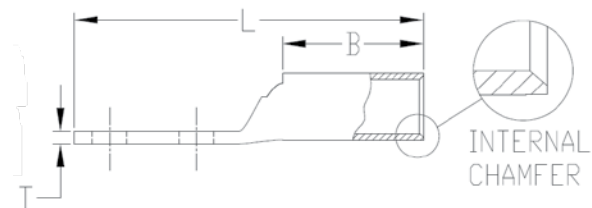
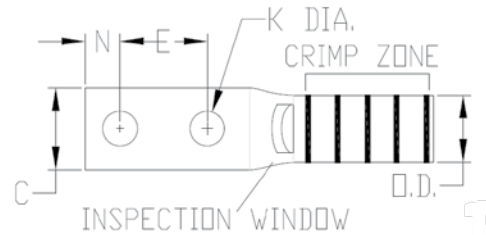

Compression Connections

Copper Compression — Terminal — Flex — Two Hole
Long Barrel — with Inspection Window

TYPE YAZ-FX (Continued)

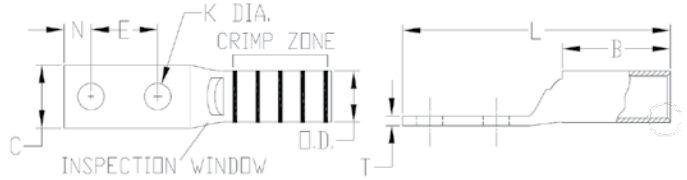

▲ See Copper Flex Long Barrel Terminal Tooling Tables in this section for complete tool and die listing information.

Catalog Number	Conductor			Color Code	Die Index	Stud Size	Figure Dimensions								Wire Strip Length
	Code	Flex	Metric MM ² ***				Stud Hole Diameter (K)	Outside Diameter (OD)	Barrel Length (B)	Pad Width (C)	Overall Length (L)	Hole Spacing (E) & (F)	Hole Offset (N)	Pad Thickness (T)	
YAZV102TC14E1	14-10 AWG	—	2.5 - 4	—	—	1/4	0.27	0.21	0.69	0.41	2.53	1.00	0.31	0.05	3/4
YAZ8C2TC10FX	#8 AWG #6 Sol #8 Sol	#8 AWG G,H,I,K,M DLO	10	Red	49	#10	0.21	0.27	0.81	0.41	2.20	5/8	0.25	0.08	1
YAZ8C2TC10E2FX						#10	0.21	0.27	0.75	0.41	2.33	3/4	0.25	0.08	
YAZ8C2TC14FX						1/4	0.27	0.27	0.81	0.44	2.32	5/8	0.31	0.08	
YAZ8C2TC14E2FX						1/4	0.27	0.27	0.81	0.44	2.45	3/4	0.31	0.08	
YAZ8C2TC14E1FX						1/4	0.27	0.27	0.81	0.44	2.70	1	0.31	0.08	
YAZ8C2TC38FX						3/8	0.40	0.27	0.81	0.58	2.89	1	0.41	0.06	
YAZV6C2TC10E2FX	#6 AWG	#6 AWG G,H,I,K,M DLO	16	Blue	7 or 374	#10	0.21	0.31	0.75	0.48	2.64	3/4	0.25	0.08	1-3/16
YAZV6C2TC14FX						1/4	0.27	0.31	0.75	0.48	2.65	5/8	0.31	0.08	
YAZV6C2TC14E2FX						1/4	0.27	0.31	0.75	0.48	2.78	3/4	0.31	0.08	
YAZV6C2TC14E1FX						1/4	0.27	0.31	0.75	0.48	3.03	1	0.31	0.08	
YAZV6C2TC38E2FX						3/8	0.40	0.31	0.75	0.58	2.97	3/4	0.41	0.06	
YAZV6C2TC38E6FX						3/8	0.40	0.31	0.75	0.58	3.09	7/8	0.41	0.06	
YAZV6C2TC38FX	3/8	0.40	0.31	0.75	0.58	2.78	1	0.41	0.06						
YAZV4C2TC14FX	#4 AWG	#4 AWG G,H,I,K,M DLO	—	Gray	8 or 346	1/4	0.27	0.38	1.25	0.55	2.83	5/8	0.31	0.09	1-5/16
YAZV4C2TC14E2FX						1/4	0.27	0.38	1.25	0.55	2.95	3/4	0.31	0.09	
YAZV4C2TC38E2-FX						3/8	0.40	0.38	1.25	0.58	3.14	3/4	0.41	0.08	
YAZV4C2TC38FX						3/8	0.40	0.38	1.25	0.58	3.39	1	0.41	0.08	
YAZV2C2TC14FX	#2 AWG	#2 AWG G,H,I,K,M DLO	35	Brown	10	1/4	0.27	0.46	1.38	0.68	3.01	5/8	0.31	0.10	1-7/16
YAZV2C2TC14E2FX						1/4	0.27	0.46	1.38	0.68	3.13	3/4	0.31	0.10	
YAZV2C2TC38FX						3/8	0.40	0.46	1.38	0.68	3.57	1	0.41	0.10	
YAZV2C2NTCFX						1/2	0.56	0.46	1.38	0.83	4.76	1-3/4	0.62	0.10	
YAZV1C2TC14FX	#1 AWG	#1 AWG G,H,I,K,M DLO	—	Green	11 or 375	1/4	0.27	0.51	1.38	0.75	3.04	5/8	0.31	0.12	1-7/16
YAZV1C2TC14E2FX						1/4	0.27	0.51	1.38	0.75	3.16	3/4	0.31	0.12	
YAZV1C2TC14E1FX						1/4	0.27	0.51	1.38	0.75	3.41	1	0.31	0.12	
YAZV1C2TC516E6FX						5/16	0.33	0.51	1.38	0.75	3.35	7/8	0.34	0.12	
YAZV1C2TC516FX						5/16	0.33	0.51	1.38	0.75	3.47	1	0.34	0.12	
YAZV1C2TC38FX						3/8	0.40	0.51	1.38	0.75	3.60	1	0.41	0.12	
YAZV252TC14FX	1/0 AWG	1/0 AWG G,H,I,K,M DLO	50	Pink	12 or 348	1/4	0.27	0.56	1.50	0.83	3.20	5/8	0.31	0.12	1-9/16
YAZV252TC14E2FX						1/4	0.27	0.56	1.50	0.83	3.32	3/4	0.31	0.12	
YAZV252TC38FX						3/8	0.40	0.56	1.50	0.83	3.76	1	0.41	0.12	
YAZV252NTCFX						1/2	0.56	0.56	1.50	0.83	4.95	1-3/4	0.62	0.12	

** The MM² conductor size referenced here is for both Class 2 and Class 5 conductor

*** The MM² conductor sizes listed are the recommendations for Class 5 conductor

◆ For applications greater than 2000 volts consult cable manufacturer for voltage stress relief instructions

Notes: All dimensions shown are for reference only.

Field bending straight lugs to achieve an angular connection will void UL Listing / CSA Certifications and BURNDY will not be liable for the connection.

TYPE YAZ-FX (Continued)

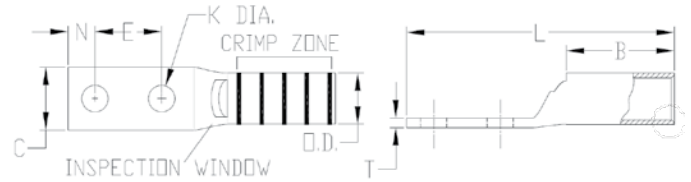

NOTE: Field bending straight lugs to achieve an angular connection will void UL Listing / CSA Certifications and BURNDY will not be liable for the connection.

Catalog Number	Conductor			Color Code	Die Index	Stud Size	Figure Dimensions								Wire Strip Length
	Code	Flex	Metric MM ² ***				Stud Hole Diameter (K)	Outside Diameter (OD)	Barrel Length (B)	Pad Width (C)	Overall Length (L)	Hole Spacing (E) & (F)	Hole Offset (N)	Pad Thickness (T)	
YAZV262TC14FX	2/0 AWG	G,H,I,K,M DLO	70	Black	13	1/4	0.27	0.63	1.50	0.93	3.20	5/8	0.31	0.13	1-9/16
YAZV262TC14E2FX						1/4	0.27	0.63	1.50	0.93	3.32	3/4	0.31	0.13	
YAZV262TC38E6FX						3/8	0.41	0.63	1.50	0.93	3.68	.88	0.41	0.13	
YAZV262TC38FX						3/8	0.41	0.63	1.50	0.93	3.76	1	0.40	0.13	
YAZV262NTCFX						1/2	0.56	0.63	1.50	0.93	4.95	1-3/4	0.62	0.13	
YAZV272TC14E2FX	3/0 AWG	G,H,I,K,M DLO	95	Orange	14	1/4	0.27	0.70	1.50	1.03	3.36	3/4	0.31	0.14	1-9/16
YAZV272TC38FX						3/8	0.41	0.70	1.50	1.03	3.80	1	0.41	0.14	
YAZV282TC14E2FX	4/0 AWG	G,H,I,K,M DLO	120	Purple	15	1/4	0.27	0.77	1.62	1.14	3.52	3/4	0.31	0.15	1-11/16
YAZV282TC38FX						3/8	0.40	0.77	1.62	1.14	3.96	1	0.41	0.15	
YAZV282NTCFX						1/2	0.56	0.77	1.62	1.14	4.93	1-3/4	0.62	0.15	
YAZV292NT516FX	250 kcmil	4/0 AWG G,H,I,K,M DLO	—	Yellow	16	5/16	0.33	0.80	2.00	0.96	4.62	1-3/4	0.34	0.16	2-1/16
YAZ302TC38FX	—	250 kcmil G,H	—	Yellow	16	3/8	0.40	0.81	2.00	1.20	4.42	1	0.41	0.16	2-1/16
YAZ312TC14E2FX	—	250 kcmil I,K,M DLO 262	150	White	17 or 298	1/4	0.27	0.88	2.00	1.29	4.02	3/4	0.31	0.18	2-1/16
YAZ312TC38FX						3/8	0.40	0.88	2.00	1.29	4.45	1	0.41	0.18	
YAZ312NTCFX						1/2	0.56	0.88	2.00	1.29	5.64	1.75	0.62	0.18	
YAZ322TC38FX	—	300 kcmil G,H,I,K,M DLO 313	185	Red	18 or 324	3/8	0.40	0.95	2.12	1.40	4.62	1	0.41	0.19	2-3/16
YAZ342TC14E2FX	—	350 kcmil G,H,I,K,M DLO 373	240	Blue	19 or 470	1/4	0.27	1.03	2.25	1.55	4.42	3/4	0.31	0.23	2-5/16
YAZ342TC38FX						3/8	0.40	1.06	2.25	1.55	4.85	1	0.41	0.23	
YAZ342NT38FX						3/8	0.40	1.06	2.25	0.96	4.85	1	0.41	0.23	
YAZ342NTCFX						1/2	0.56	1.06	2.25	1.55	6.04	1-3/4	0.62	0.23	
YAZ362TC38FX	—	500 kcmil G,H DLO 444	—	Brown	20 or 299	3/8	0.40	1.19	2.69	1.74	5.55	1	0.50	0.27	2-3/4
YAZ382NT38FX	—	500 kcmil H,I,K 550 kcmil G,H,I DLO 535	300	Pink	L99	3/8	0.41	1.25	2.81	1.62	5.72	1	0.50	0.27	2-7/8
YAZ382TC38FX						3/8	0.41	1.25	2.81	1.84	5.72	1	0.50	0.27	
YAZ382NNTFX						1/2	0.56	1.25	2.81	1.62	6.72	1-3/4	0.62	0.27	
YAZ382NTCFX						1/2	0.56	1.25	2.81	1.84	6.72	1-3/4	0.62	0.27	
YAZ402NTCFX	—	650 kcmil G DLO 646	—	Black	24	1/2	0.56	1.35	2.94	1.98	6.89	1-3/4	0.62	0.30	3
YAZ442NT38FX	—	750 kcmil G,H DLO 777	—	Yellow	L115	3/8	0.40	1.50	3.00	1.62	6.08	1	0.50	0.33	3-1/16

** The MM² conductor size referenced here is for both Class 2 and Class 5 conductor

*** The MM² conductor sizes listed are the recommendations for Class 5 conductor

▲ See Copper Flex Long Barrel Terminal Tooling Tables in this section for complete tool and die listing information.

◆ For applications greater than 2000 Volts consult cable manufacturer for voltage stress relief instructions

Note: All dimensions shown are for reference only

Compression Connections

Copper Compression — Terminal — Flex — Two Hole
Belled End, Long Barrel — No Inspection Window

TYPES YA-2TC-FXB, YAV-2TC-FXB

HYLUG™

Uninsulated Copper Compression Terminal
UL Listed 90° C, Up to 35 kV ♦

45° and 90° angles available. Please contact Customer Service to order:
1-800-346-4175

Features & Benefits

- No inspection window is ideal for more corrosive environments as the barrel transition is not open
- Barrel is designed with a “belled” end opening at the wire entry, to ensure smooth insertion of highly flexible stranded wire, preventing possible damaging of the wire strands during insertion
- Long barrel allows for an increased number of crimps which will increase the mechanical strength of the connection
- Two hole tongue/tang is recommended when space permits as the 2-hole feature minimizes the terminations from loosening or rotating under vibration, movement, or heat cycling
- 45° and 90° angular lugs are available; please contact Customer Service
- Electro-tin plated unless otherwise specified to reduce galvanic corrosion (bimetallic) and resist corrosive elements
- Connectors are clearly marked with stamping and barrel color coding
- Connectors accommodating wire sizes #10 - 250 kcmil accommodate both Flex and Code Wire. See Tables on each page for specific details
- Tables in this section identify flex wire as the nominal flex wire size followed by the wire classes and DLO wire size and stranding. For Class Wire Strand counts, see the table at the beginning of this section.
- BURNDY certifies its products using the BURNDY Engineered System and select other crimp tool manufacturers in accordance with one or more of the UL categories in order to obtain a UL Listing

Accessories

- Hardware - Section F
- PENETROX™ Oxide Inhibitor - Section F
- Heat and Cold Shrink Tubing - Section D
- WIREMIKE™ Wire Micrometer - Section F
- Wire Management (Cable Ties) - Section G

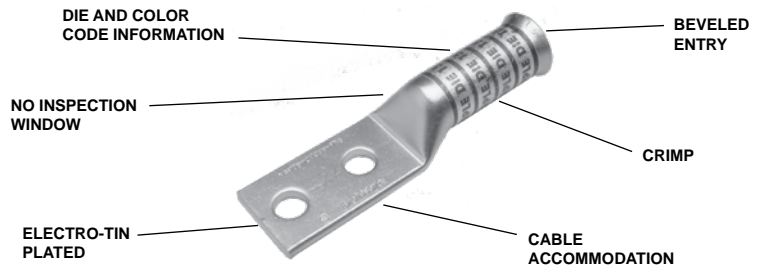

NOTE: Field bending straight lugs to achieve an angular connection will void UL Listing / CSA Certifications and BURNDY will not be liable for the connection.

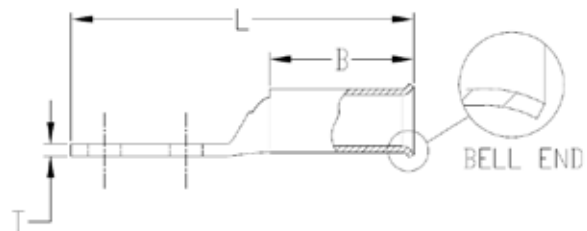
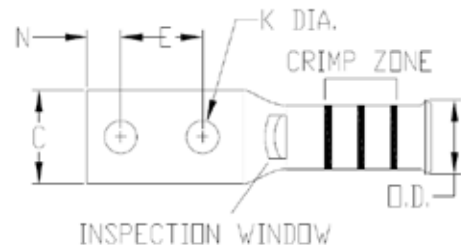

TYPES YA-2TC-FXB, YAV-2TC-FXB (Continued)

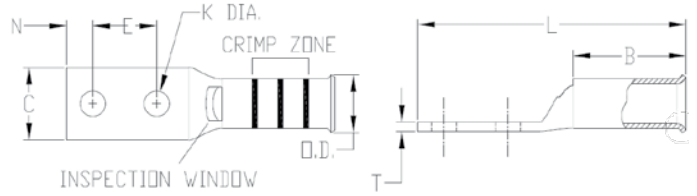

▲ See Copper Flex Long Barrel Terminal Tooling Tables in this section for complete tool and die listing information.

Catalog Number	Conductor			Color Code	Die Index	Stud Size	Figure Dimensions								Wire Strip Length
	Code	Flex	Metric MM ² ***				Stud Hole Diameter (K)	Outside Diameter (OD)	Barrel Length (B)	Pad Width (C)	Overall Length (L)	Hole Spacing (E) & (F)	Hole Offset (N)	Pad Thickness (T)	
YA8C2TC14E2FXB	#8 AWG #6 Sol #8 Sol	#8 AWG G,H,I,K,M DLO	10	Red	49	1/4	0.27	0.27	0.90	0.44	2.54	3/4"	0.31	0.08	1
YA8C2TC38FXB						3/8	0.40	0.27	0.90	0.58	2.98	1"	0.41	0.06	
YAV6C2TC14E2FXB	#6 AWG	#6 AWG G,H,I,K,M DLO	16	Blue	7	1/4	0.27	0.31	1.22	0.48	2.88	3/4"	0.31	0.08	1-5/16
YAV6C2TC14FXB						1/4	0.27	0.31	1.22	0.48	2.76	5/8"	0.31	0.08	
YAV6C2TC38FXB						3/8	0.40	0.31	1.22	0.58	3.32	1"	0.41	0.06	
YAV6C2NFXB						1/2	0.56	0.31	1.22	0.83	4.51	1-3/4"	0.62	0.12	
YAV4C2TC14E2FXB	#4 AWG	#4 AWG G,H,I,K,M DLO	—	Gray	8	1/4	0.27	0.38	1.22	0.55	2.93	3/4"	0.31	0.09	1-5/16
YAV4C2TC14FXB						1/4	0.27	0.38	1.22	0.55	2.81	5/8"	0.31	0.09	
YAV4C2TC516FXB						5/16	0.33	0.38	1.22	0.55	3.24	1"	0.34	0.09	
YAV4C2TC38FXB						3/8	0.41	0.38	1.22	0.58	3.37	1"	0.41	0.09	
YAV4C2NFXB						1/2	0.56	0.38	1.22	0.83	4.56	1-3/4"	0.62	0.12	
YA3C2TC516FXB	#3 AWG	#3 AWG G,H,I,K,M DLO	—	White	9	5/16	0.33	0.42	1.48	0.55	3.51	1"	0.34	0.09	1-9/16
YA3C2TC38FXB						3/8	0.41	0.42	1.48	0.58	3.64	1"	0.41	0.09	
YAV3C2NFXB						1/2	0.56	0.42	1.48	0.83	4.83	1.75"	0.62	0.12	
YAV2C2TC14E1FXB	#2 AWG	#2 AWG G,H,I,K,M DLO	35	Brown	10	1/4	0.27	0.46	1.35	0.68	3.38	1"	0.31	0.10	1-7/16
YAV2C2TC14E2FXB						1/4	0.27	0.46	1.35	0.68	3.13	3/4"	0.31	0.10	
YAV2C2TC14FXB						1/4	0.27	0.46	1.35	0.68	3.00	5/8"	0.31	0.10	
YAV2C2TC38FXB						3/8	0.41	0.46	1.35	0.68	3.57	1"	0.41	0.10	
YAV2C2TC516FXB						5/16	0.33	0.46	1.35	0.68	3.44	1"	0.34	0.10	
YAV2C2NFXB						1/2	0.56	0.46	1.35	0.83	4.76	1-3/4"	0.62	0.12	
YAV1C2TC38FXB	#1 AWG	#1 AWG G,H,I,K,M DLO	—	Green	11	3/8	0.41	0.51	1.50	0.75	3.74	1"	0.41	0.12	1-9/16
YAV1C2NFXB						1/2	0.56	0.51	1.50	0.83	4.92	1-3/4"	0.62	0.11	
YAV252TC14E2FXB	1/0 AWG	1/0 AWG G,H,I,K,M DLO	50	Pink	12	1/4	0.27	0.56	1.50	0.83	3.34	3/4"	0.31	0.12	1-9/16
YAV252TC14FXB						1/4	0.27	0.56	1.50	0.83	3.21	5/8"	0.31	0.12	
YAV252TC38FXB						3/8	0.40	0.56	1.50	0.83	3.78	1"	0.41	0.12	
YAV262TC14E2FXB	2/0 AWG	2/0 AWG G,H,I,K,M DLO	70	Black	13	1/4	0.27	0.63	1.63	0.93	3.52	3/4"	0.31	0.13	1-13/16
YAV262TC14FXB						1/4	0.27	0.63	1.63	0.93	3.40	5/8"	0.31	0.13	
YAV262NTC38FXB						3/8	0.40	0.63	1.63	0.93	4.71	1-3/4"	0.41	0.13	
YAV262TC38FXB						3/8	0.40	0.63	1.63	0.93	3.96	1"	0.41	0.13	
YAV262NFXB						1/2	0.56	0.63	1.63	0.93	5.15	1-3/4"	0.62	0.13	
YAV272TC14E2FXB	3/0 AWG	3/0 AWG G,H,I,K,M DLO	95	Orange	14	1/4	0.27	0.70	1.64	1.03	3.58	3/4"	0.31	0.14	1-13/16
YAV272TC38FXB						3/8	0.40	0.70	1.64	1.03	4.01	1"	0.41	0.14	
YAV272NFXB						1/2	0.56	0.70	1.64	1.03	5.20	1-3/4"	0.62	0.14	

*** The MM² conductor sizes listed are the recommendations for Class 5 conductor

♦ For applications greater than 2000 volts consult cable manufacturer for voltage stress relief instructions

Notes: All dimensions shown are for reference only.

Field bending straight lugs to achieve an angular connection will void UL Listing / CSA Certifications and BURNDY will not be liable for the connection.

Compression Connections

Copper Compression — Terminal — Flex — Two Hole
Belled End, Long Barrel — No Inspection Window

TYPES YA-2TC-FXB, YAV-2TC-FXB (Continued)

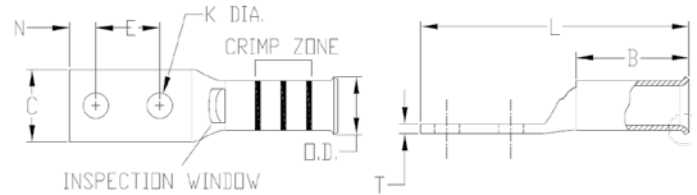

▲ See Copper Flex Long Barrel Terminal Tooling Tables in this section for complete tool and die listing information.

Catalog Number	Conductor			Color Code	Die Index	Stud Size	Figure Dimensions								Wire Strip Length
	Code	Flex	Metric MM ² ***				Stud Hole Diameter (K)	Outside Diameter (OD)	Barrel Length (B)	Pad Width (C)	Overall Length (L)	Hole Spacing (E) & (F)	Hole Offset (N)	Pad Thickness (T)	
YAV282TC14E2FXB	4/0 AWG	4/0 AWG G,H,I,K,M DLO	120	Purple	15	1/4	0.27	0.77	1.77	1.14	3.76	3/4"	0.31	0.14	1-7/8
YAV282TC38FXB						3/8	0.40	0.77	1.77	1.14	4.20	1"	0.41	0.14	
YAV282NT38FXB						3/8	0.40	0.77	1.77	1.14	4.20	1"	0.41	0.14	1-7/8
YAV282NTC38FXB						3/8	0.40	0.77	1.77	1.14	4.20	1-3/4"	0.41	0.14	
YAV282NFXB						1/2	0.56	0.77	1.77	1.14	5.39	1-3/4"	0.62	0.14	
YAV292TC14E2FXB	250 kcmil	4/0 AWG G,H,I,K,M DLO	—	Yellow	16	1/4	0.27	0.80	2.16	1.18	4.19	3/4"	0.31	0.16	2-1/4
YAV292TC38FXB						3/8	0.40	0.80	2.16	1.18	3.62	1"	0.41	0.16	
YAV292NT38FXB						3/8	0.40	0.80	2.16	0.75	5.54	1"	0.41	0.16	
YAV292NTC38FXB						3/8	0.40	0.80	2.16	1.18	5.37	1-3/4"	0.41	0.16	
YAV292NFXB						1/2	0.56	0.80	2.16	1.18	5.81	1-3/4"	0.62	0.16	
YA302NFXB	—	250 kcmil G,H	—	Yellow	16	1/2	0.56	0.81	2.16	1.20	5.80	1-3/4"	0.62	0.16	2-1/4
YA312TC38FXB	—	250 kcmil 4/0 AWG G,H,I,K,M DLO (550/24)	150	White	17	3/8	0.40	0.88	2.18	1.29	4.66	1"	0.41	0.18	2-1/4
YA312NFXB						1/2	0.56	0.88	2.18	1.29	5.85	1-3/4"	0.62	0.18	
YA322TC38FXB	—	300 kcmil G,H,I,K,M DLO 313 (775/24)	185	Red	18	3/8	0.40	0.95	2.32	1.40	4.85	1"	0.41	0.19	2-1/4
YA322NFXB						1/2	0.56	0.95	2.32	1.40	6.04	1-3/4"	0.62	0.19	
YA342TC38FXB	—	350 kcmil G,H,I,K,M DLO 373 (925/24)	240	Blue	19	3/8	0.40	1.06	2.48	1.55	5.10	1"	0.41	0.23	2-9/16
YA342NFXB						1/2	0.56	1.06	2.48	1.55	6.29	1-3/4"	0.62	0.23	
YA362NFXB	—	500 kcmil G,H DLO 444 (110/24)	300	Brown	20	1/2	0.56	1.18	2.95	1.73	6.84	1-3/4"	0.62	0.26	3-1/16
YA382NFXB	—	500 kcmil H,I,K 550 kcmil G,H,I DLO 535 (325/24)	300	Pink	L99	1/2	0.56	1.25	3.08	1.84	7.01	1-3/4"	0.62	0.26	3-3/16
YA382FXBG2						1/2	0.40	1.25	3.08	1.84	6.82	2"	0.41	0.27	
YA382FXBG3						1/2	0.52	1.25	3.08	1.84	6.26	1-3/16"	0.53	0.27	
YA382TC38FXB						3/8	0.40	1.25	3.08	1.84	6.01	1"	0.50	0.26	
YA402NFXB	—	650 kcmil G DLO 646 (1600/24)	400	Black	24	1/2	0.56	1.35	3.24	1.98	7.22	1-3/4"	0.62	0.30	3-5/16
YA442TC38FXB	—	750 kcmil G,H DLO 777 (1925/24)	500	Yellow	L115	3/8	0.40	1.50	3.33	2.19	6.44	1"	0.50	0.33	3-7/16
YA442NFXB						1/2	0.56	1.50	3.33	2.19	7.44	1-3/4"	0.62	0.33	
YA462NFXB	—	1111 kcmil DLO (2750/24)	—	—	29	1/2	0.56	1.84	3.58	2.69	7.91	1-3/4"	0.62	0.39	3-11/16

*** The MM² conductor sizes listed are the recommendations for Class 5 conductor

◆ For applications greater than 2000 volts consult cable manufacturer for voltage stress relief instructions

Notes: All dimensions shown are for reference only.

Field bending straight lugs to achieve an angular connection will void UL Listing / CSA Certifications and BURNDY will not be liable for the connection.

TYPES YAZ-2-NTFX, YAZV-2NTFX

HYLUG™

Uninsulated Copper Compression Terminal
UL Listed 90° C, Up to 35 kV ♦

45° and 90° angles available. Please contact Customer Service to order:
1-800-346-4175

Features & Benefits

- Inspection window allows for visual verification that the wire has been fully inserted prior to crimping the lug
- Narrow tongue/tang is designed to allow for more parallel terminations of wire in limited space applications
- Barrel is designed with an internal chamfer at the wire entry to ensure smooth insertion of the wire, preventing possible damaging of the wire strands during insertion
- Long barrel allows for an increased number of crimps which will increase the mechanical strength of the connection
- Two hole tongue/tang is recommended when space permits as the 2-hole feature minimizes the terminations from loosening or rotating under vibration, movement, or heat cycling
- 45° and 90° angular lugs are available; please contact Customer Service
- Electro-tin plated unless otherwise specified to reduce galvanic corrosion (bimetallic) and resist corrosive elements
- Connectors are clearly marked with stamping and barrel color coding
- Connectors accommodating wire sizes #10 - 250 kcmil accommodate both Flex and Code Wire. See Tables on each page for specific details
- Tables in this section identify flex wire as the nominal flex wire size followed by the wire classes and DLO wire size and stranding. For Class Wire Strand counts, see the table at the beginning of this section.
- BURNDY certifies its products using the BURNDY Engineered System and select other crimp tool manufacturers in accordance with one or more of the UL categories in order to obtain a UL Listing

Accessories

- Hardware - Section F
- PENETROX™ Oxide Inhibitor - Section F
- Heat and Cold Shrink Tubing - Section D
- WIREMIKE™ Wire Micrometer - Section F
- Wire Management (Cable Ties) - Section G

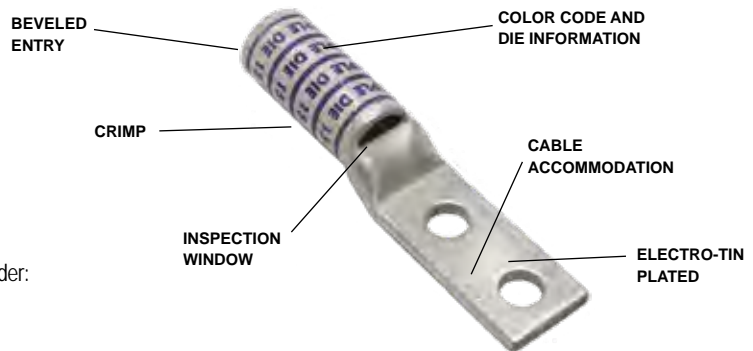

NOTE: Field bending straight lugs to achieve an angular connection will void UL Listing / CSA Certifications and BURNDY will not be liable for the connection.

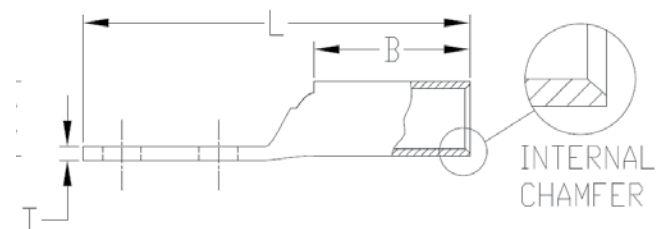
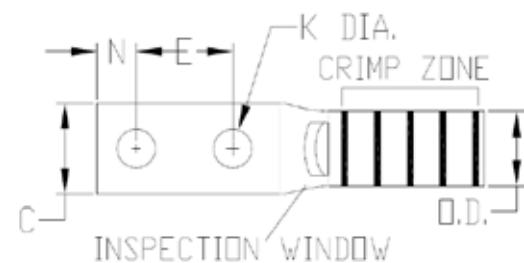

Compression Connections

Copper Compression — Terminal — Flex — Two Hole
Narrow Tongue, Long Barrel — with Inspection Window

TYPES YAZ-2-NTFX, YAZV-2NTFX (Continued)

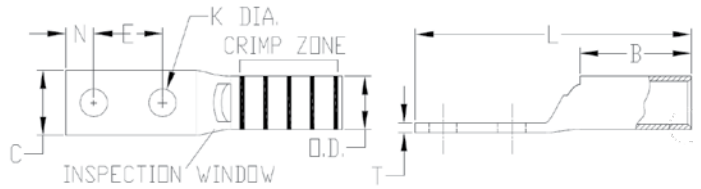

▲ See Copper Flex Long Barrel Terminal Tooling Tables in this section for complete tool and die listing information.

Catalog Number	Conductor			Color Code	Die Index	Stud Size	Figure Dimensions								Wire Strip Length
	Code	Flex	Metric MM ² ***				Stud Hole Diameter (K)	Outside Diameter (OD)	Barrel Length (B)	Pad Width (C)	Overall Length (L)	Hole Spacing (E) & (F)	Hole Offset (N)	Pad Thickness (T)	
YAZV4C2NT14E2FX	#4 AWG	#4 AWG G,H,I,K,M DLO	—	Gray	8	1/4	0.27	0.38	1.25	0.44	2.95	0.75	0.31	0.09	1-5/16
YAZV2C2NT14E2FX	#2 AWG	#2 AWG G,H,I,K,M DLO	35	Brown	10	1/4	0.27	0.46	1.38	0.50	3.14	0.75	0.31	0.10	1-7/16
YAZV252NT14FX	1/0 AWG	1/0 AWG G,H,I,K,M DLO	—	Pink	12 or 348	1/4	0.27	0.56	1.50	0.48	3.35	.62	0.31	0.12	1-9/16
YAZV282NT38FX	4/0 AWG	4/0 AWG G,H,I,K,M DLO	—	Purple	15	3/8	0.40	0.77	1.62	0.94	3.96	1.00	0.41	0.17	1-11/16
YAZV292NT516FX	250 kcmil	4/0 AWG G,H,I,K,M DLO	—	Yellow	16	5/16	0.33	0.80	2.00	0.96	4.28	1.00	0.34	0.16	2-1/16
YAZ342NT38FX	—	350 kcmil G,H,I,K,M DLO 373	240	Blue	19	3/8	0.40	1.06	2.25	0.96	4.85	1.00	0.41	0.23	2-5/16
YAZ382ENT38FX	—	500 kcmil H,I,K	300	Pink	L99	3/8	0.41	1.25	2.81	1.46	5.72	1.00	0.50	0.27	2-7/8
YAZ382NT38FX		550 kcmil G,H,I				3/8	0.41	1.25	2.81	1.62	5.72	1.00	0.50	0.27	
YAZ382NNTFX		DLO 535				1/2	0.56	1.25	2.81	1.62	6.72	1.75	0.62	0.27	
YAZ442NT38FX	—	750 kcmil G,H DLO 777	500	Yellow	L115	3/8	0.40	1.50	3.00	1.62	6.09	1.00	0.50	0.33	3-1/16

*** The MM² conductor sizes listed are the recommendations for Class 5 conductor

◆ For applications greater than 2000 volts consult cable manufacturer for voltage stress relief instructions

Notes: All dimensions shown are for reference only.

Field bending straight lugs to achieve an angular connection will void UL Listing / CSA Certifications and BURNDY will not be liable for the connection.

TYPE YAZV-2TC-FXSL

HYLUG™

Uninsulated Copper Compression Terminal
UL Listed 90° C, Up to 35 kV ♦

Compression slotted lugs connect copper or tinned copper conductors to bus bars, CPI racks, cabinets or cable runway. Slotted and 90° slotted lugs have one round and one oblong hole to match hole spacing on equipment mounting rails on CPI racks and cabinets and on some bus bars.



NOTE: Field bending straight lugs to achieve an angular connection will void UL Listing / CSA Certifications and BURNDY will not be liable for the connection.

Features & Benefits

- Inspection window allows for visual verification that the wire has been fully inserted prior to crimping the lug
- Barrel is designed with an internal chamfer at the wire entry to ensure smooth insertion of the wire, preventing possible damaging of the wire strands during installation
- Long barrel allows for an increased number of crimps which will increase the mechanical strengths of the connection
- One hole with slotted second hole tongue/tang offers additional flexibility over a standard 2-hole tongue/tang as the slot provides the installer with multiple mounting hole alignments options. The 2-hole feature minimizes the terminations from loosening or rotating under vibration, movement or heat cycling
- 45° and 90° angular lugs are available; please contact Customer Service
- Electro-tin plated unless specified to reduce galvanic corrosion (bimetallic) and resist corrosive elements
- Connectors are clearly marked with stamping and barrel color coding
- BURNDY certifies its products using the BURNDY Engineered System and select other crimp tool manufacturers in accordance with one or more of the UL categories in order to obtain a UL Listing

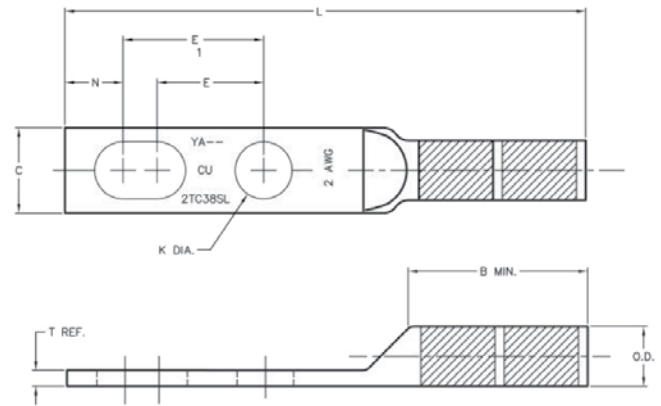

Fig. 1

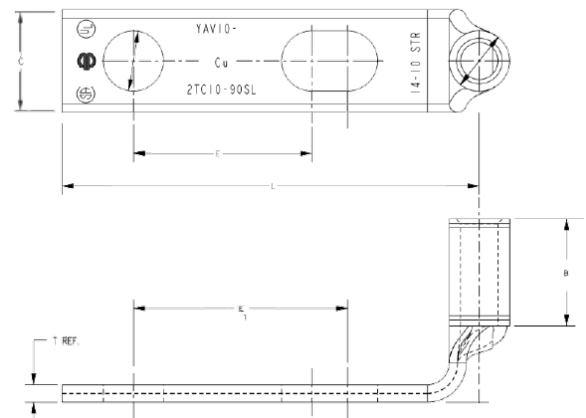

Fig. 2

Accessories

- Hardware - Section F
- PENETROX™ Oxide Inhibitor - Section F
- Heat and Cold Shrink Tubing - Section D
- WIREMIKE™ Wire Micrometer - Section F
- Wire Management (Cable Ties) - Section G

Compression Connections

Copper Compression — Terminal — Flex — Slotted
Long Barrel — with Inspection Window

TYPE YAZV-2TC-FXSL (Continued)



NOTE: Field bending straight lugs to achieve an angular connection will void UL Listing / CSA Certifications and BURNDY will not be liable for the connection.



Catalog Number	Cond. Size	Stud Hole Size	Fig.	Tongue Width	Figure Dimensions					Installation Tooling (# of crimps)					Wire Strip Length	
					(B)	(T)	(L)	(E)	(E1)	Dieless	MD6, OUR840, MD734R	500 Series	35, 750, 46** Series	Color Code		Die Index
YAZV102TC14SL	14 - 10 AWG	1/4	2	0.41	0.69	0.05	2.28	0.62	0.75	Y8MRB1 (1)	—	—	—	—	—	3/4
YAV102TC1090SL*		#10	1	0.36	0.38	0.06	1.46	0.63	0.75							
YAZV6C2TC38FXSLBOX500	#6 AWG G,H,I,K,M DLO (61/24)	3/8	1	0.58	1.12	0.08	3.22	0.63	1	MY29 Series (1)	W5CRT (2) W5CVT (2)	W5CRT (2) W5CVT (2)	U8CABT (2)	Blue	7 or 374	1-3/16
YAZV6C2TC38FXSL		3/8	1	0.58	1.12	0.08	3.22	0.63	1							
YAZV6C2TC14FXSLBOX500		1/4	1	0.58	1.12	0.08	3.22	0.63	1							
YAZV6C2TC14FXSL		1/4	1	0.58	1.12	0.08	3.22	0.63	1							
YAZV6C2TC10FX90SL		#10	1	0.48	0.75	0.08	1.50	0.75	1							
YAZV4C2TC14FXSL	#4 AWG G,H,I,K,M DLO (105/24)	1/4	1	0.55	1.25	0.09	2.95	0.63	1	MY29 Series (1) 644 Series (1) 444 Series (1) 81K Series (1)	W4CRT (2) W4CVT (2) X4CRT (2)	W4CRT (2) W4CVT (2) X4CRT (2)	U4CRT (2)	Gray	8 or 346	1-5/16
YAZV4C2TC14FXSLBOX500		1/4	1	0.55	1.25	0.09	2.95	0.63	1							
YAZV4C2TC38FXSL		3/8	1	0.55	1.25	0.09	2.95	0.63	1							
YAZV4C2TC38FXSLBOX500		3/8	1	0.55	1.25	0.09	2.95	0.63	1							
YAZV2C2TC14FXSL	#2 AWG G,H,I,K,M DLO (150/24)	1/4	1	0.60	1.25	0.11	3.42	0.75	1	MY29 Series (1) 644 Series (1) 444 Series (1)	W2CRT (2) W2CVT (2)	W2CRT (2) W2CVT (2)	U2CRT (2)	Brown	10	1-5/16
YAZV2C2TC14FXSLBOX500		1/4	1	0.60	1.25	0.11	3.42	0.75	1							
YAZV2C2TC38FXSL		3/8	1	0.60	1.25	0.11	3.42	0.75	1							
YAZV2C2TC38FXSLBOX500		3/8	1	0.60	1.25	0.11	3.42	0.75	1							
YAZV252TC14FXSL		1/0 AWG G,H,I,K,M DLO (275/24)	1/4	1	0.83	1.50	0.12	3.44	0.63							
YAZV252TC14FXSLBOX500	1/4		1	0.83	1.50	0.12	3.44	0.63	1							
YAZV252TC38FXSL	3/8		2	0.83	1.50	0.12	3.44	0.63	1							
YAZV252TC38FXSLBOX500	3/8		2	0.83	1.50	0.12	3.44	0.63	1							
YAZV262TC14FXSL	2/0 AWG G,H,I,K,M DLO (325/24)	1/4	1	0.93	1.50	0.13	3.58	0.63	1	MY29 Series (1) 644 Series (1) 444 Series (1)	W26RT (4) W26VT (4) X26RT (4)	W26RT (4) W26VT (4) X26RT (4)	U26RT (2)	Black	13	1-9/16
YAZV262TC14FXSLBOX500		1/4	1	0.93	1.50	0.13	3.58	0.63	1							
YAZV262TC38FXSL		3/8	1	0.93	1.50	0.13	3.58	0.63	1							
YAZV262TC38FXSLBOX500		3/8	1	0.93	1.50	0.13	3.58	0.63	1							
YAZV282TC14FXSL	4/0 AWG G,H,I,K,M DLO (550/24)	1/4	1	1.14	1.62	0.15	3.64	0.63	1	MY29 Series (1) 644 Series (1) 444 Series (1)	W28VT (4) W28RT (4) X28RT (6)	W28VT (4) W28RT (4) X28RT (6)	U28RT (2)	Purple	15	1-11/16
YAZV282TC14FXSLBOX500		1/4	1	1.14	1.62	0.15	3.64	0.63	1							
YAZV282TC38FXSL		3/8	1	1.14	1.62	0.15	3.64	0.63	1							
YAZV282TC38FXSLBOX500		3/8	1	1.14	1.62	0.15	3.64	0.63	1							

* Denotes 90° Angle

** Use PUADP1 adapter with U dies in 46 Series of tools

Note: All dimensions shown are for reference only.

Catalog Number Type	Wire Size	Color Code and Die Index Number	Mechanical & Ratchet Dies Required (# Crimps)		Mechanical & Ratchet Dedicated Die Tools # Crimps				
	Conductor (CU Only)		MD6 and MD7 Series <small>*Due to handle force not recommended</small>	OUR840 <small>*Due to handle force not recommended</small>	MY28 and MY29 Series	MRC840	MRE1022B Y8MRB1 Y10D Y1022	Y122CMR	Y1MRTC
YA-10	#14 - #10 AWG B,C,I,K,M DLO	—	—	—	—	—	2 CRIMPS	—	—
YA-8C-FX	#8 AWG B,C,G,H,I,K,M DLO #6 Sol / #8 Sol	RED 49	X8CRT (2) W8CRT (2) W8CVT (2)	X8CRT (2) W8CRT (2) W8CVT (2)	2 CRIMPS	2 CRIMPS	—	2 CRIMPS	2 CRIMPS
YA-6C-FX	#6 AWG Sol B,C,G,H,I,K,M DLO	BLUE 7	X5CRT (2) W5CRT (2) W5CVT (2)	X5CRT (2) W5CVT (2)	2 CRIMPS	2 CRIMPS	—	2 CRIMPS	2 CRIMPS
YA-4C-FX	#4 AWG B,C,G,H,I,K,M DLO	GRAY 8	X4CRT (2) W4CRT (2) W4CVT (2)	X4CRT (2) W4CVT (2)	2 CRIMPS	2 CRIMPS	—	4 CRIMPS	4 CRIMPS
YA-3C-FX	#3 AWG B,C,G,H,I,K,M DLO	WHITE 9	W3CRT (1)	—	2 CRIMPS	2 CRIMPS	—	4 CRIMPS	4 CRIMPS
YA-2C-FX	#2 AWG B,C,G,H,I,K,M DLO	BROWN 10	X2CRT (2) W2CRT (2) W2CVT (2)	X2CRT (2) W2CVT (2)	2 CRIMPS	2 CRIMPS	—	4 CRIMPS	4 CRIMPS
YA-1C-FX	#1 AWG B,C,G,H,I,K,M DLO	GREEN 11	X1CRT1 (2) W1CRT1 (2) W1CVT (2)	X1CRT1 (2) W1CVT (2)	2 CRIMPS	2 CRIMPS	—	—	—
YA-25-FX	1/0 AWG B,C,G,H,I,K,M DLO	PINK 12	X25RT (4) W25RT (4) W25VT (4)	X25RT (4) W25RT (4)* W25VT (4)*	2 CRIMPS	4 CRIMPS	—	—	—
YA-26-FX	2/0 AWG B,C,G,H,I,K,M DLO	BLACK 13	X26RT (4) W26RT (4) W26VT (4)	X26RT (4) W26RT (4)* W26VT (4)*	2 CRIMPS	4 CRIMPS	—	—	—
YA-27-FX	3/0 AWG B,C,G,H,I,K,M DLO	ORANGE 14	X27RT (4) W27RT (4) W27VT (4)	X27RT (4) W27RT (4)* W27VT (4)*	2 CRIMPS	4 CRIMPS	—	—	—
YA-28-FX	4/0 AWG B,C,G,H,I,K,M DLO	PURPLE 15	X28RT (6) W28RT (4) W28VT (4)	X28RT (6) W28RT (4)* W28VT (4)*	2 CRIMPS	4 CRIMPS	—	—	—
YA-29-FX	250 kcmil B,C 4/0 AWG G,H,I,K,M DLO	YELLOW 16	X29RT (8) W29RT (4)* W29VT (4)	X29RT (8) W29RT (4)* W29VT (4)*	2 CRIMPS	—	—	—	—
YA-30-FX	250 kcmil G, H	YELLOW 16	X29RT (4) W29RT (4)* W29VT (4)	X29RT (8) W29RT (4)* W29VT (4)*	—	—	—	—	—
YA-31-FX	250 kcmil I,K,M 262 DLO	WHITE 17	W30RT (4)* W30VT (4)	—	—	—	—	—	—
YA-32-FX	300 kcmil G,H,I,K,M 313 DLO	RED 18	W31RT (4)* W31VT (4)	—	—	—	—	—	—
YA-34-FX	350 kcmil G,H,I,K,M 373 DLO	BLUE 19	W32RT (4)* W32VT (4)	—	—	—	—	—	—

Compression Connections

Copper Flex Long Barrel Terminal Tooling Table
Hydraulic Requiring Dies and Dieless

Catalog Number Type	Wire Size	Color Code and Die Index Number	Hydraulic Tools - Dies Required (# Crimps)					Hydraulic Tools - Dieless	
	Conductor (CU Only)		MD6, 600, 500 Series	750, 35 Series	45 Series <i>Use PT6515 with U Dies</i>	46 Series <i>Use PUADP1 with U Dies</i>	60 Series	81K 4PC Series	644 444 Series
YA-10	#14 - #10 AWG B,C,I,K,M DLO	—	—	—	—	—	—	—	—
YA-8C-FX	#8 AWG B,C,G,H,I,K,M DLO #6 Sol / #8 Sol	RED 49	X8CRT (2) W8CRT (2) W8CVT (2)	U8CRT (2)	U8CRT (2)	U8CRT (2)	—	1 CRIMP	—
YA-6C-FX	#6 AWG Sol B,C,G,H,I,K,M DLO	BLUE 7	X5CRT (2) W5CRT (2) W5CVT (2)	U5CRT (2)	U5CRT (2)	U5CRT (2)	—	1 CRIMP	—
YA-4C-FX	#4 AWG B,C,G,H,I,K,M DLO	GRAY 8	X4CRT (2) W4CRT (2) W4CVT (2)	U4CRT (2)	U4CRT (2)	U4CRT (2)	—	1 CRIMP	1 CRIMP
YA-3C-FX	#3 AWG B,C,G,H,I,K,M DLO	WHITE 9	X3CRT (2)	U3CRT (2)	U3CRT (2)	U3CRT (2)	—	1 CRIMP	1 CRIMP
YA-2C-FX	#2 AWG B,C,G,H,I,K,M DLO	BROWN 10	X2CRT (2) W2CRT (2) W2CVT (2)	U2CRT (2)	U2CRT (2)	U2CRT (2)	—	1 CRIMP	1 CRIMP
YA-1C-FX	#1 AWG B,C,G,H,I,K,M DLO	GREEN 11	X1CRT1 (2) W1CRT1 (2) W1CVT (2)	U1CRT1 (2)	U1CRT1 (2)	U1CRT1 (2)	—	1 CRIMP	1 CRIMP
YA-25-FX	1/0 AWG B,C,G,H,I,K,M DLO	PINK 12	X25RT (4) W25RT (4) W25VT (4)	U25RT (2)	U25RT (2)	U25RT (2)	—	2 CRIMPS	1 CRIMP
YA-26-FX	2/0 AWG B,C,G,H,I,K,M DLO	BLACK 13	X26RT (4) W26RT (4) W26VT (4)	U26RT (2)	U26RT (2)	U26RT (2)	—	2 CRIMPS	1 CRIMP
YA-27-FX	3/0 AWG B,C,G,H,I,K,M DLO	ORANGE 14	X27RT (6) W27RT (4) W27VT (4)	U27RT (2)	U27RT (2)	U27RT (2)	—	2 CRIMPS	1 CRIMP
YA-28-FX	4/0 AWG B,C,G,H,I,K,M DLO	PURPLE 15	X28RT (6) W28RT (4) W28VT (4)	U28RT (2)	U28RT (2)	U28RT (2)	L28RT (1)	2 CRIMPS	1 CRIMP
YA-29-FX	250 kcmil B,C 4/0 AWG G,H,I,K,M DLO	YELLOW 16	X29RT (8) W29RT (4) W29VT (4)	U29RT (2)	U29RT (2)	U29RT (2)	L29RT (1)	2 CRIMPS	1 CRIMP
YA-30-FX	250 kcmil G, H	YELLOW 16	X29RT (8) W29RT (4) W29VT (4)	U29RT (2)	U29RT (2)	U29RT (2)	L29RT (1)	2 CRIMPS	1 CRIMP
YA-31-FX	250 kcmil I,K,M 262 DLO	WHITE 17	X30RT (4) W30VT (4)	U30RT (4)	U30RT (4)	U30RT (4)	L30RT (1)	2 CRIMPS	1 CRIMP
YA-32-FX	300 kcmil G,H,I,K,M 313 DLO	RED 18	X31RT (4) W31VT (4)	U31RT (4)	U31RT (4)	U31RT (4)	L31RT (1)	2 CRIMPS	1 CRIMP

Catalog Number Type	Wire Size	Color Code and Die Index Number	Hydraulic Tools - Dies Required (# Crimps)					Hydraulic Tools - Dieless	
	Conductor (CU Only)		MD6, 600, 500 Series	750, 35 Series	45 Series <i>Use PT6515 with U Dies</i>	46 Series <i>Use PUADP1 with U Dies</i>	60 Series	81K 4PC Series	644 444 Series
YA-34-FX	350 kcmil G,H,I,K,M 373 DLO	BLUE 19	W32RT (4) W32VT (4)	U32RT (4)	U32RT (4)	U32RT (4)	L32RT (1)	2 CRIMPS	1 CRIMP
YA-36-FX	500 kcmil G,H 444 DLO	BROWN 20	—	U34RT (4)	U34RT (4)	U34RT (4)	L34RT (1)	2 CRIMPS	1 CRIMP
YA-38-FX	500 kcmil H,I,K 550 kcmil G,H,I 535 DLO	PINK L99	—	U38XRT (4)	U38XRT (4)	U38XRT (4)	—	2 CRIMPS	1 CRIMP
YA-39-FX	600 kcmil G,H,I,K DLO	PINK 400	—	U38RT (2)	U38RT (2)	U38RT (2)	—	3 CRIMPS	1 CRIMP
YA-40-FX	650 kcmil G 646 DLO	BLACK 24	—	U39RT (4)	U39RT (4)	U39RT (4)	L39RT (1)	3 CRIMPS	1 CRIMP
YA-44-FX	750 kcmil G,H,I 777 DLO	YELLOW L115	—	U44XRT (4)	U44XRT (4)	U44XRT (4) P44XRT (4)	—	3 CRIMPS	1 CRIMP
YA-45-FX	929 kcmil DLO	WHITE 27	—	—	S44RT (4)	P44RT (4)	L44RT (2)	—	—

Installation Instructions

Installation instructions help the installer understand proper wire preparation, proper insertion requirements, crimp zone location, individual crimp location, crimp order and crimp direction, to ensure safe and reliable wire connections. UL Listing and CSA Certification are only valid when using the BURNDY® Engineered System and following BURNDY Installation Instructions.

Copper Code Long Barrel Terminal Installation Steps:

1. Select the appropriate connector based on:
 - Wire Material
 - Wire Construction
 - Wire Size
2. Strip the insulation to the appropriate wire strip length, based on the table's Wire Strip Length recommendation for the selected connector. Due to tolerances in the connector, wire strip length, and insulation stripping tools, this range may be 0" - 1/4". The exposed wire, also known as a "shiner", has no performance impact on the connection and there is no wire exposure requirement by BURNDY.
3. As a best practice, wire brush the bare conductor to remove any oxides. DO NOT wire brush tin-plated connectors.
4. Insert the conductor into the barrel for the full length. If the connector has an inspection window, the conductor end can easily be seen to verify full wire insertion.
5. Apply the proper number of crimps specified by the appropriate illustration.
6. Once all crimps have been completed, the connection can be easily inspected for proper installation.

NOTE: Illustrations show black bands however this is just a representation of the crimp zones. See individual connector for actual crimp band color.

CATALOG NUMBER DESIGNATIONS				
YA-8C-FX	YA-6C-FX	YA-4C-FX	YA-3C-FX	YA-2C-FX
YA-1C-FX				

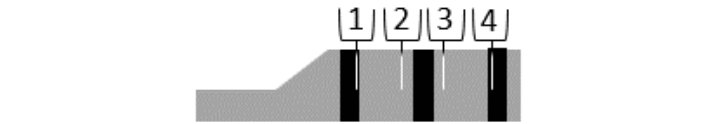

CATALOG NUMBER DESIGNATIONS				
YA-25-FX	YA-26-FX	YA-27-FX	YA-28-FX	YA-29-FX
YA-30-FX	YA-31-FX	YA-32-FX	YA-34-FX	YA-36-FX
YA-38-FX	YA-39-FX	YA-40-FX	YA-44-FX	YA-45-FX

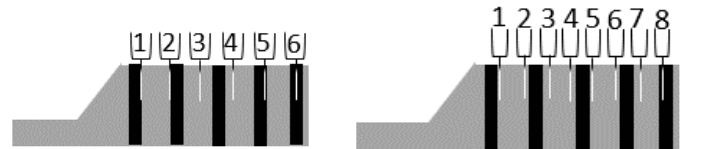
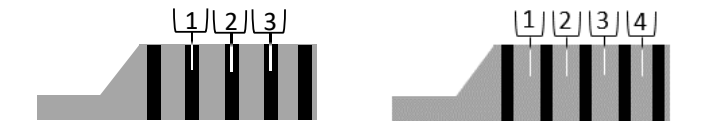

Example: YAZV282NT38FX

- Go to the YA-28-FX Catalog Number Designation for 4/0 AWG G,H,I,K,M or DLO.
- Confirm the Tool (750 Series for this example).
- Confirm the Die Set Needed (U28RT for this example)
- Confirm the Number of Crimps Necessary (2 for this example)
- For proper crimp placement refer to the image on this page corresponding to the number of crimps.



YAZV282NT38FX

750 Series Tool

U28RT Die Set

Completed Crimp Installation

TYPE YA-A

HYLUG™

UL Listed 90° C, Up to 35 kV ◆



Type YA-A aluminum tin-plated compression HYLUG™ terminals are dual-rated and designed for use on both aluminum and copper conductors from #12 solid through 2000 kcmil.

▲ See Type YA-A Installation Tooling Table for Aluminum Terminals in this section for complete tool and die listing information.

Features & Benefits

- UL486A-486B Listed and CSA Certified
- Aluminum terminals are dual rated to accommodate both copper and aluminum wire and are indicated with AL-CU on the connector:
 - AL9CU indicates the terminal can accommodate aluminum and copper wire and is UL Listed 90°C, up to 35kV
 - AL7CU indicates the terminal can accommodate aluminum and copper wire and is UL Listed 75°C, up to 35kV
- Barrel is designed with an internal chamfer at the wire entry to ensure smooth insertion of the wire, preventing possible damaging of the wire strands during insertion
- 45° and 90° angular lugs are available, please contact Customer Service
- Electro-tin plated unless otherwise specified to reduce galvanic corrosion (bimetallic) and resist corrosive elements
- Connectors are clearly marked with wire size, die index, color code, and crimp location bands
- Factory pre-filled with PENETROX™ Type A13 oxide inhibitor
- Color coded end caps are factory inserted in the barrels to match the die color code and prevent foreign materials from entering the barrel
- Aluminum oxidation is not easily detected but causes resistance in a connection; it is imperative the proper preparation takes place prior to making an aluminum-to-aluminum connection
- BURNDY certifies its products using the BURNDY Engineered System and select other crimp tool manufacturers in accordance with one or more of the UL categories in order to obtain a UL Listing
- Connectors have been tested with expanded wire ranges when installed with specified dieless tools. See Beginning of Section C for Expanded Ranges Tables.
- Conductor Accommodate Types:
 - Aluminum Code Wire: Class B (Concentric, Compressed, Compact)
 - Copper Code Wire: Class B (Concentric, Compressed, Compact or Class C)
 - Copper Clad Aluminum: Noted in the conductor accommodates as CCA

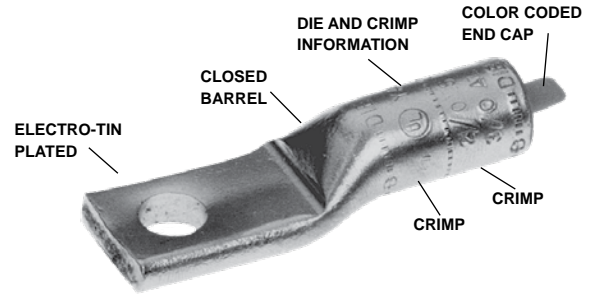

NOTE: Field bending straight lugs to achieve an angular connection will void UL Listing / CSA Certifications and BURNDY will not be liable for the connection.

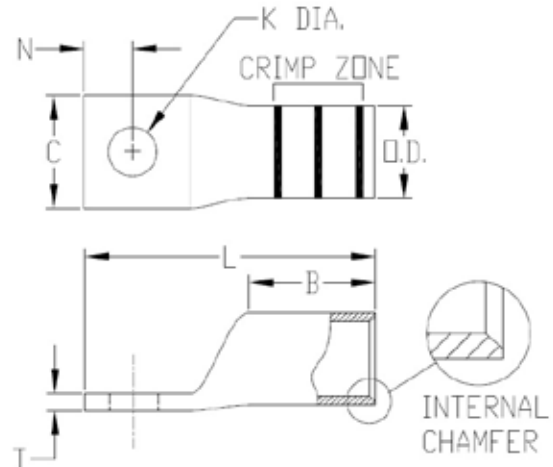

Accessories

- Hardware - Section F
- PENETROX™ Oxide Inhibitor - Section F
- Heat and Cold Shrink Tubing - Section D
- WIREMIKE™ Wire Micrometer - Section F
- Wire Management (Cable Ties) - Section G

Compression Connections

Aluminum / Copper — One Hole
Uninsulated Aluminum Terminals

TYPE YA-A (Continued)



AL9CU

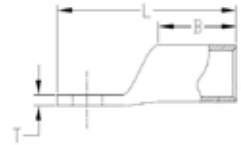
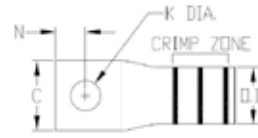

▲ See Type YA-A Installation Tooling Table for Aluminum Terminals in this section for complete tool and die listing information.

Catalog Number	AL / Cu Conductor	Dimensions									Color Code	Die Index	Wire Strip Length	Temperature Rating
		Stud Size	Stud Hole Diameter (K)	No. of Holes in Pad	Outside Diameter (OD)	Barrel Length (B)	Pad Width (C)	Overall Length (L)	Hole Offset (N)	Pad Thickness (T)				
YA12ATN*	12 AWG 12 Sol.	#10	0.20	1	0.21	0.50	0.41	1.19	0.20	0.07	—	—	5/8	75° C
YA10ATN*	10 AWG 10 Sol.	#10	0.20	1	0.21	0.50	0.41	1.22	0.20	0.06	—	—	5/8	75° C
YA8CA1	8 AWG	#10	0.20	1	0.30	0.62	0.53	1.50	0.20	0.09	Blue	374	5/8	75° C
YA8CA3		1/4	0.28	1	0.30	0.62	0.53	1.65	0.25	0.09				
YA6CA1	6 AWG	1/4	0.28	1	0.34	0.75	0.47	1.84	0.33	0.14	Gray	346	3/4	90° C
YA6CA3		3/8	0.44	1	0.34	0.75	0.65	2.28	0.44	0.09				
YA4CA1	4 AWG	1/4	0.28	1	0.43	0.88	0.47	2.13	0.33	0.18	Green	375	7/8	90° C
YA4CA3		5/16	0.38	1	0.43	0.88	0.80	2.25	0.41	0.12				
YA4CA6		3/8	0.44	1	0.43	0.88	0.80	2.32	0.44	0.12				
YA2CA5	2 AWG	1/4	0.28	1	0.53	1.00	0.50	2.25	0.33	0.22	Pink	348	1-1/8	90° C
YA2CA1		5/16	0.38	1	0.53	1.12	0.88	2.50	0.41	0.16				
YA2CA3		3/8	0.44	1	0.53	1.12	0.88	2.56	0.44	0.16				
YA1CA1	1 AWG	3/8	0.44	1	0.54	0.91	0.76	2.59	0.44	0.19	Gold	471	15/16	90° C
YA25A1	1/0 AWG	5/16	0.38	1	0.60	1.00	0.60	2.31	0.41	0.21	Tan	296	1-1/16	90° C
YA25A3		3/8	0.44	1	0.60	1.05	0.82	2.67	0.63	0.21				
YA25A9		1/2	0.56	1	0.60	1.05	1.03	2.83	0.63	0.17				
YA26A7	2/0 AWG	5/16	0.38	1	0.67	1.17	0.67	2.52	0.41	0.24	Olive	297	1-3/8	90° C
YA26A6		3/8	0.44	1	0.67	1.17	0.67	2.79	0.44	0.24				
YA26A1		1/2	0.56	1	0.67	1.17	1.03	3.03	0.63	0.20				
YA26A8		5/8	0.69	1	0.67	1.17	1.03	3.03	0.63	0.20				
YA27A1	3/0 AWG	3/8	0.44	1	0.76	1.11	0.73	2.88	0.44	0.26	Ruby	467	1-1/2	90° C
YA27A3		1/2	0.56	1	0.76	1.31	1.04	3.27	0.63	0.26				
YA28A1	4/0 AWG	3/8	0.44	1	0.85	1.39	1.17	3.26	0.44	0.30	White	298	1-5/8	90° C
YA28A3		1/2	0.56	1	0.85	1.39	1.17	3.44	0.63	0.30				
YA29A9	250 kcmil	3/8	0.41	1	0.92	1.45	1.26	3.09	0.41	0.33	Red	324	1-9/16	90° C
YA29A1		1/2	0.56	1	0.92	1.45	1.26	3.53	0.63	0.33				
YA29A6		5/8	0.69	1	0.92	1.45	1.26	3.69	0.75	0.33				
YA30A6	300 kcmil	3/8	0.44	1	1.01	1.53	1.38	3.90	0.63	0.36	Blue	470	1-3/4	90° C
YA30A1	4/0 AWG CCA DLO (329/22)	1/2	0.56	1	1.01	1.53	1.38	3.90	0.63	0.36				
YA31A6	350 kcmil	3/8	0.44	1	1.11	1.85	1.52	3.95	0.44	0.39	Brown	299	2-1/8	90° C
YA31A1	250 kcmil	1/2	0.56	1	1.11	1.85	1.52	4.33	0.63	0.39				
YA31A12	CCA DLO (399/22)	5/8	0.65	1	1.11	1.85	1.52	4.33	0.44	0.39				
YA32A9	400 kcmil	3/8	0.41	1	1.19	2.26	1.62	3.95	0.41	0.43	Green	472	2-5/16	90° C
YA32A6		1/2	0.56	1	1.19	2.26	1.62	4.92	0.88	0.43			2-1/2	90° C
YA32A1		5/8	0.69	1	1.19	2.26	1.62	4.92	0.88	0.43			2-1/2	90° C
YA34A7	500 kcmil	1/2	0.56	1	1.32	2.34	1.80	5.02	0.63	0.46	Pink	300	2-5/8	90° C
YA34A1	350 kcmil CCA DLO (551/22)	5/8	0.69	1	1.32	2.34	1.80	5.56	0.88	0.46				

* Contact BURNDY® for conductor, stud sizes and hole drillings not shown.

◆ For applications greater than 2000 Volts consult cable manufacturer for voltage stress relief instructions.

* AL Conductor Only

Note: All dimensions shown are for reference only.

Field bending straight lugs to achieve an angular connection will void UL Listing / CSA Certifications and BURNDY will not be liable for the connection.

TYPE YA-A (Continued)



AL9CU

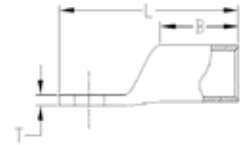
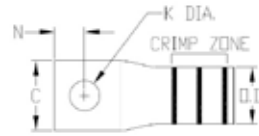

▲ See Type YA-A Installation Tooling Table for Aluminum Terminals in this section for complete tool and die listing information.

Catalog Number	AL / Cu Conductor	Dimensions									Color Code	Die Index	Wire Strip Length	Temperature Rating
		Stud Size	Stud Hole Diameter (K)	No. of Holes in Pad	Outside Diameter (OD)	Barrel Length (B)	Pad Width (C)	Overall Length (L)	Hole Offset (N)	Pad Thickness (T)				
YA36A8	600 kcmil	1/2	0.56	1	1.44	2.47	1.97	5.64	0.69	0.52	Black	473	2-7/8	90° C
YA36A1	500 kcmil CCA DLO (779/22)	5/8	0.69	1	1.44	2.47	1.97	5.82	0.88	0.52				
YA39A1	700 - 750 kcmil	1/2	0.56	1	1.46	2.46	2.05	5.26	0.63	0.43	Yellow	936	2-7/8	90° C
YA39A3	600 kcmil Compact AL†	5/8	0.69	1	1.46	2.46	2.05	5.80	0.88	0.43				
YA39A34	900 kcmil CCA DLO (925/22)	3/4	0.81	1	1.46	2.46	2.05	6.17	1.00	0.43				
YA42A1	900 kcmil AL	1/2	0.56	1	1.50	2.46	2.14	5.32	0.63	0.39	Gray	303	2-7/8	90° C
YA42A3		5/8	0.69	1	1.50	2.46	2.14	5.32	0.66	0.39				
YA44A1	1000 kcmil 750 kcmil CCA DLO (1194/22) 800 kcmil CCA DLO (1258/22)	5/8	0.69	1	1.84	2.74	2.50	6.50	0.88	0.66	Brown	302	3	90° C

- Contact BURNDY® for conductor, stud sizes and hole drillings not shown.
- ◆ For applications greater than 2000 Volts consult cable manufacturer for voltage stress relief instructions.
- * AL Conductor Only

Note: All dimensions shown are for reference only.

Field bending straight lugs to achieve an angular connection will void UL Listing / CSA Certifications and BURNDY will not be liable for the connection.

TYPE YA-A

HYLUG™

UL Listed 90° C, Up to 35 kV ◆



Type YA-A terminals in 2- and 4-hole designs inhibit connector rotation and increase area contact. These aluminum terminals have the same design features and benefits as the 1-hole YA-A with an added stud hole for a more secure termination to various types of equipment pads. They are dual-rated for use on both aluminum and copper conductors.

▲ See Type YA-A Installation Tooling Table for Aluminum Terminals in this section for complete tool and die listing information.

Features & Benefits

- UL486A-486B Listed and CSA Certified
- Aluminum terminals are dual rated to accommodate both copper and aluminum wire and are indicated with AL-CU on the connector:
 - AL9CU indicates the terminal can accommodate aluminum and copper wire and is UL Listed 90°C, up to 35kV
 - AL7CU indicates the terminal can accommodate aluminum and copper wire and is UL Listed 75°C, up to 35kV
- Barrel is designed with an internal chamfer at the wire entry to ensure smooth insertion of the wire, preventing possible damaging of the wire strands during insertion
- 45° and 90° angular lugs are available, please contact Customer Service
- Electro-tin plated unless otherwise specified to reduce galvanic corrosion (bimetallic) and resist corrosive elements
- Connectors are clearly marked with wire size, die index, color code, and crimp location bands
- Factory pre-filled with PENETROX™ Type A13 oxide inhibitor
- Color coded end caps are factory inserted in the barrels to match the die color code and prevent foreign materials from entering the barrel
- Aluminum oxidation is not easily detected but causes resistance in a connection; it is imperative the proper preparation takes place prior to making an aluminum-to-aluminum connection
- BURNDY certifies its products using the BURNDY Engineered System and select other crimp tool manufacturers in accordance with one or more of the UL categories in order to obtain a UL Listing
- Connectors have been tested with expanded wire ranges when installed with specified dieless tools. See Beginning of Section C for Expanded Ranges Tables.
- Conductor Accommodate Types:
 - Aluminum Code Wire: Class B (Concentric, Compressed, Compact)
 - Copper Code Wire: Class B (Concentric, Compressed, Compact or Class C)
 - Copper Clad Aluminum: Noted in the conductor accommodates as CCA

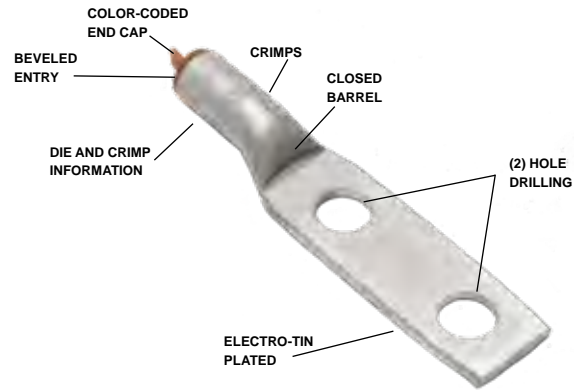

NOTE: Field bending straight lugs to achieve an angular connection will void UL Listing / CSA Certifications and BURNDY will not be liable for the connection.

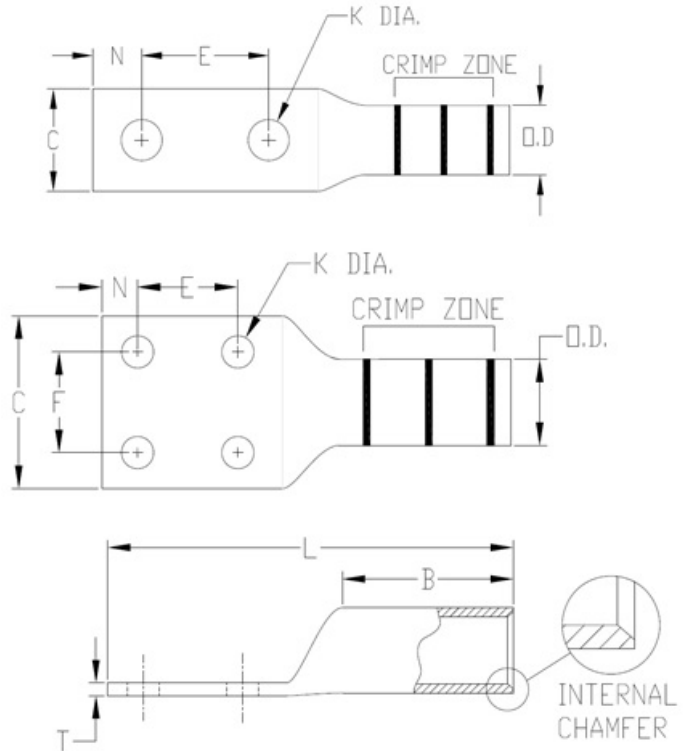

Accessories

- Hardware - Section F
- PENETROX™ Oxide Inhibitor - Section F
- Heat and Cold Shrink Tubing - Section D
- WIREMIKE™ Wire Micrometer - Section F
- Wire Management (Cable Ties) - Section G

TYPE YA-A (Continued)



AL9CU

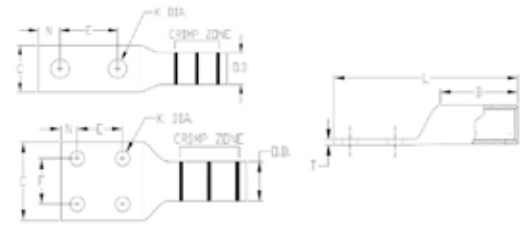

▲ See Type YA-A Installation Tooling Table for Aluminum Terminals in this section for complete tool and die listing information.

Catalog Number	AL / Cu Conductor	Stud Size	Stud Hole Diameter (K)	No. of Holes in Pad	Dimensions								Color Code	Die Index	Wire Strip Length	Temperature Rating
					Outside Diameter (OD)	Barrel Length (B)	Pad Width (C)	Overall Length (L)	Hole Spacing (E)	Hole Spacing (F)	Hole Offset (N)	Pad Thickness (T)				
YA2CA9	2 AWG	1/2	0.56	2	0.53	1.12	0.88	4.73	1.75	—	0.63	0.16	Pink	348	1-1/8	90° C
YA25A7	1/0 AWG	1/2	0.56	2	0.60	1.05	1.03	4.59	1.75	—	0.63	0.17	Tan	296	1-1/16	90° C
YA25A5		3/8	0.44	2	0.60	1.05	0.82	3.73	1.06	—	0.63	0.21				
YA26A3	2/0 AWG	1/2	0.56	2	0.67	1.17	1.03	4.78	1.75	—	0.63	0.20	Olive	297	1-3/8	90° C
YA26A5		3/8	0.44	2	0.67	1.17	0.92	3.56	1.00	—	0.44	0.24				
YA27A7	3/0 AWG	3/8	0.44	2	0.76	1.31	1.04	3.79	1.00	—	0.44	0.26	Ruby	467	1-1/2	90° C
YA27A5		1/2	0.56	2	0.76	1.31	1.04	5.02	1.75	—	0.63	0.26				
YA28A7	4/0 AWG	3/8	0.44	2	0.85	1.39	1.17	3.97	1.00	—	0.44	0.30	White	298	1-5/8	90° C
YA28A5		1/2	0.56	2	0.85	1.39	1.17	5.19	1.75	—	0.63	0.30				
YA29A5	250 kcmil	3/8	0.44	2	0.92	1.45	1.26	4.06	1.00	—	0.44	0.33	Red	324	1-5/8	90° C
YA29A3		1/2	0.56	2	0.92	1.45	1.26	5.28	1.75	—	0.63	0.33				
YA30A5	300 kcmil	3/8	0.44	2	1.01	1.53	1.38	4.42	1.00	—	0.44	0.36	Blue	470	1-3/4	90° C
YA30A3	4/0 AWG CCA DLO (329/22)	1/2	0.56	2	1.01	1.53	1.38	5.64	1.75	—	0.63	0.36				
YA31A5	350 kcmil	3/8	0.44	2	1.11	1.85	1.52	4.85	1.00	—	0.44	0.39	Brown	299	2-1/8	90° C
YA31A3	250 kcmil CCA DLO (399/22)	1/2	0.56	2	1.11	1.85	1.52	6.07	1.75	—	0.63	0.39				
YA32A5	400 kcmil	3/8	0.44	2	1.19	2.26	1.62	4.93	1.00	—	0.44	0.43	Green	472	2	90° C
YA32A3		1/2	0.56	2	1.19	2.26	1.62	6.15	1.75	—	0.63	0.43				
YA34A5	500 kcmil	3/8	0.44	2	1.32	2.34	1.80	5.54	1.00	—	0.44	0.46	Pink	300	2-5/8	90° C
YA34A3 †	350 kcmil CCA DLO (551/22)	1/2	0.56	2	1.32	2.34	1.62	6.80	1.75	—	0.63	0.46				
YA36A5	600 kcmil	3/8	0.44	2	1.44	2.47	1.97	5.64	1.00	—	0.69	0.52	Black	473	2-7/8	90° C
YA36A3 †	500 kcmil CCA DLO (779/22)	1/2	0.56	2	1.44	2.47	1.62	7.09	1.75	—	0.63	0.52				

† Narrow tongue design; may be mounted side-by-side on a 4-hole NEMA pad

• Contact BURNDY® for conductor, stud sizes and hole drillings not shown.

◆ For applications greater than 2000 Volts consult cable manufacturer for voltage stress relief instructions.

* AL Conductor Only

Note: All dimensions shown are for reference only.

Field bending straight lugs to achieve an angular connection will void UL Listing / CSA Certifications and BURNDY will not be liable for the connection.

Compression Connections

Aluminum / Copper — Two and Four Hole
Uninsulated Aluminum Terminals

TYPE YA-A (Continued)



AL9CU

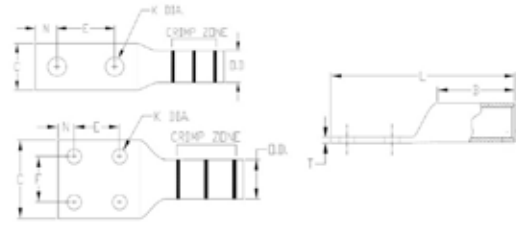

▲ See Type YA-A Installation Tooling Table for Aluminum Terminals in this section for complete tool and die listing information.

Catalog Number	AL / Cu Conductor	Stud Size	Stud Hole Diameter (K)	No. of Holes in Pad	Dimensions								Color Code	Die Index	Wire Strip Length	Temperature Rating
					Outside Diameter (OD)	Barrel Length (B)	Pad Width (C)	Overall Length (L)	Hole Spacing (E)	Hole Spacing (F)	Hole Offset (N)	Pad Thickness (T)				
YA39A7	700 - 750 kcmil	3/8	0.44	2	1.46	2.46	2.05	5.81	1.00	—	0.44	0.43	Yellow	936	2-7/8	90° C
YA39A5 †	900 kcmil Compact AL*	1/2	0.56	2	1.46	2.46	1.62	7.07	1.75	—	0.63	0.43				
YA39AM2	600 kcmil CCA DLO (925/22)	1/2	0.56	2	1.60	2.56	1.69	7.31	1.75	—	0.63	0.57	Red	301	2-7/8	90° C
YA42A7	900 kcmil AL	3/8	0.44	2	1.50	2.46	2.14	5.96	1.00	—	0.44	0.39	Gray	303	2-7/8	90° C
YA42A5		1/2	0.56	2	1.50	2.46	1.62	7.09	1.75	—	0.63	0.39				
YA44A3 †	1000 kcmil 750 kcmil CCA DLO (1194/22) 800 kcmil CCA DLO (1258/22)	1/2	0.56	2	1.84	2.74	1.65	7.76	1.75	—	0.63	0.55	Brown	302	3	90° C
YA44A8		1/2	0.56	2	1.84	2.74	2.50	7.76	1.75	—	0.63	0.66				
YA45A5	1250 kcmil 900 kcmil CCA DLO (1406/22) 1000 kcmil CCA DLO (1554/22)	1/2	0.56	2	1.84	2.74	2.59	7.73	1.75	—	0.63	0.51	Brown	302	3	75° C
YA46A3	1500 kcmil	1/2	0.56	2	2.26	3.30	3.08	8.73	1.75	—	0.63	0.81	Blue	478	2-3/4	75° C
YA46A5		1/2	0.56	4	2.26	3.30	3.08	8.73	1.75	1.75	0.63	0.81				
YA48A3	2000 kcmil	1/2	0.56	2	2.60	3.69	3.57	8.49	1.75	—	0.63	0.90	Red	479	4-1/8	75° C

† Narrow tongue design; may be mounted side-by-side on a 4-hole NEMA pad

• Contact BURNDY® for conductor, stud sizes and hole drillings not shown.

◆ For applications greater than 2000 Volts consult cable manufacturer for voltage stress relief instructions.

* AL Conductor Only

Note: All dimensions shown are for reference only.

Field bending straight lugs to achieve an angular connection will void UL Listing / CSA Certifications and BURNDY will not be liable for the connection.

TYPE YA-E

E-LINE HYLUG™ Equipment Line



UL Listed 90° C, Up to 35 kV ♦

Type YA-E Equipment terminals are designed to provide replacements for original equipment mechanical or other compression terminals. These narrow tongue terminals are specially designed to fit in tight areas. Whether you're upgrading or replacing, YA-E connectors will provide for any of your cable termination needs. When installed with our dieless tool, these terminals can accommodate a range of conductor sizes.



Features & Benefits

- Narrow tongue/tang is designed to allow for more parallel terminations of wire in limited space applications
- Terminals are available in aluminum material
- Aluminum terminals are dual rated to accommodate both copper and aluminum wire and are indicated with AL-CU on the connector:
 - AL9CU indicates the terminal can accommodate aluminum and copper wire and is UL Listed 90°C, up to 35kV
 - AL7CU indicates the terminal can accommodate aluminum and copper wire and is UL Listed 75°C, up to 35kV
- Barrel is designed with an internal chamfer at the wire entry to ensure smooth insertion of the wire
- One or two-hole tongue/tang styles are available; 2-hole tongue/tang is recommended when space permits as the 2-hole feature minimizes the terminations from loosening or rotating under vibration, movement or heat cycling
- Electro-tin plated unless specified to reduce galvanic corrosion (bimetallic) and resist corrosive elements
- Connectors are clearly marked with stamping
- Overlap crimps should crimp the entire crimp zone
- BURNDY certifies its products using the BURNDY Engineered System and select other crimp tool manufacturers in accordance with one or more of the UL categories in order to obtain a UL Listing
- Terminals and splices accommodating code wire: Accommodates Code Class B (Concentric, Compressed, Compact) and Class C wire

NOTE: Field bending straight lugs to achieve an angular connection will void UL Listing / CSA Certifications and BURNDY will not be liable for the connection.

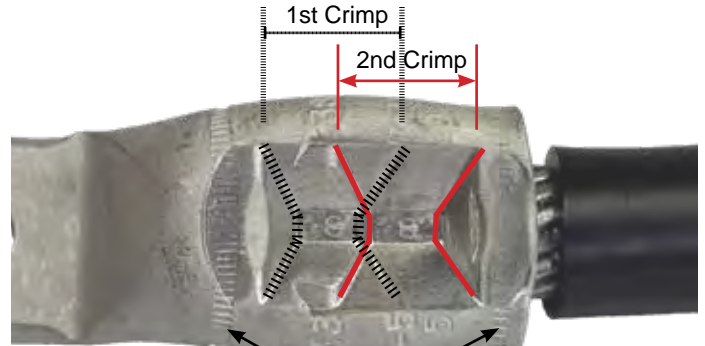

When overlapping crimps, ensure pyramid crimp shapes are within knurl marks.

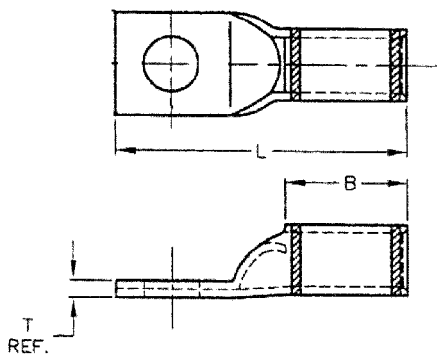

Fig. 1

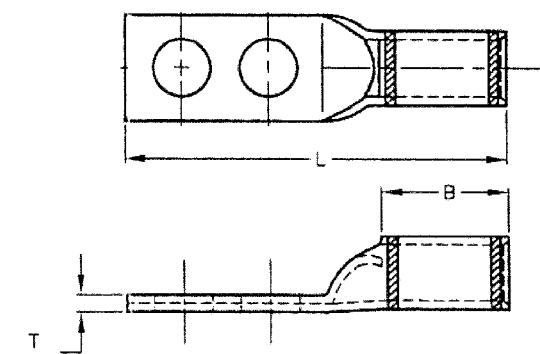

Fig. 2

Compression Connections

Aluminum — Terminal — Code — One / Two Hole
Narrow Tongue, Standard Barrel

TYPE YA-E (Continued)



NOTE: Field bending straight lugs to achieve an angular connection will void UL Listing / CSA Certifications and BURNDY will not be liable for the connection.

ALUMINUM E-LINE HYLUG™ COMPRESSION TERMINALS

Catalog Number	Fig. No.	Conductor Accommodations		Stud Hole Size	Stud Hole Spacing	Tongue Width (max)	Dimensions			† Installation Tooling				Wire Strip Length
		Aluminum	Copper or Aluminum				B	T	L	Dieless (# of crimps)	35, 750, 46* Series (# of crimps)	Color Code	Die Index	
		AWG/KCMIL	Expanded Wire Range using 644 / 444 Series											
YA8CA3S56T14E	1	#8 AWG	—	1/4	—	0.56	0.62	0.09	1.65	81K Series (1)	U8CABT (1)	Blue	374	11/16
YA2CA5S53T14E	1	#2 AWG	#6 - #2 AWG	1/4	—	0.53	1.00	0.22	2.25	644 Series (1) 444 Series (1)	U2CABT (1)	Pink	348	1-3/16
YA2CA1S91T516E				5/16	—	0.91	1.12	0.16	2.50					
YA25A1S60T516E	1	1/0 AWG	#1 - 1/0 AWG	5/16	—	0.63	1.00	0.21	2.29	81K Series (1)	U25ART (1)	Tan	296	1-1/8
YA25A3N69T38E				3/8	—	0.69	1.05	0.21	2.38					
YA26A13N100T516E	1	2/0 AWG	#1 - 2/0 AWG	5/16	—	1.00	1.11	0.24	2.45	644 Series (1) 444 Series (1) 81K Series (2)	U26ART (2)	Olive	297	1-3/16
YA26A6N100T38E				3/8	—	1.00	1.11	0.24	2.53					
YA27A10S76T516E	1	3/0 AWG	#1 - 3/0 AWG	5/16	—	0.76	1.11	0.26	2.58	644 Series (1) 444 Series (1) 81K Series (2)	U27ART (2)	Ruby	467	1-3/16
YA28A14N100T516E	1	4/0 AWG	1/0 - 4/0 AWG	3/8	—	1.00	1.39	0.30	2.85					
YA28A1N100T38E				5/16	—	1.00	1.39	0.30	2.94					
YA30A9N100T516E	1	300 kcmil	2/0 AWG - 300 kcmil	5/16	—	1.00	1.53	0.36	3.12	644 Series (2) 444 Series (2) 81K Series (2)	U30ART (2)	Blue	470	1-5/8
YA30A6N100T38E				3/8	—	1.00	1.53	0.36	3.20					
YA30A1N131T12E				1/2	—	1.31	1.53	0.35	3.57					
YA31A11N100T516E	1	350 kcmil	3/0 AWG - 350 kcmil	5/16	—	1.00	1.85	0.39	3.51	644 Series (1) 444 Series (1) 81K Series (2)	U31ART (2)	Brown	299	1-7/8
YA31A9N100T38E				3/8	—	1.00	1.85	0.39	3.59					
YA32A8N106T516E	1	400 kcmil	4/0 AWG - 400 kcmil	5/16	—	1.06	2.26	0.43	3.92	644 Series (2) 444 Series (2) 81K Series (2)	U32ART (4)	Green	472	2-5/16
YA34A8N131T38E **	1	500 kcmil	4/0 AWG - 500 kcmil	3/8	—	1.31	1.64	0.35	3.88					
YA34A7N131T12E **				1/2	—	1.31	1.64	0.35	3.88					
YA34A3N131T12E **	2	600 kcmil	250 - 600 kcmil	1/2	1.75	1.31	1.64	0.39	5.71	644 Series (2) 444 Series (2) 81K Series (2)	U34ART (4)	Pink	300	1-11/16
YA36A9N131TD12E **	1			1/2	—	1.31	1.64	0.39	3.98					
YA36A3N131TD38E **	1			3/8	—	1.31	1.64	0.39	5.32					
YA36A3N131TD12E **	2	750 kcmil	500 - 900 @ kcmil Aluminum 500 kcmil Copper Only	1/2	1.75	1.31	1.64	0.39	5.71	644 Series (2) 444 Series (2) 81K Series (2)	U34ART (4)	Pink	300	1-15/16
YA39A1N131TD12E **	1			1/2	—	1.31	1.86	0.31	4.28					
YA39A5N131TD12E **	2			1/2	1.75	1.31	1.86	0.31	6.09					

† A variety of BURNDY® installation tools are available and not all tools are listed. If you require additional tooling information, please feel free to call our customer service department for other recommendations.

* Use PUADP1 adapter with U dies in 46 Series, P-RT die sets for use in 46 Series only, PUADP1 adapter not required.

Note: All dimensions shown are for reference only.

**Overlap crimps when using U Dies, 644 or 444 Series Tools.

Type YA-A Installation Tooling Table for Aluminum Terminals
Mechanical/Ratchet (Dedicated Die or Requiring Dies)

Compression Connections

Catalog Number Type	Wire Size	Wire Strip Length	Color Code and Die Index Number	Mechanical & Ratchet Dies Required (# Crimps)		Mechanical & Ratchet Dedicated Die Tools # Crimps	
	Class B, C Conductor (AL/CU)			MD6 and MD7 Series	OUR840	MY28 and MY29 Series	MRC840AL
YA8CA-	#8 AWG	5/8	Blue 374	X8CART (2) W374 (1)	X8CART (2)	1 Crimp	1 Crimp
YA6CA-	#6 AWG	3/4	Gray 346	X6CART (2)	X6CART (2)	1 Crimp	1 Crimp
			No Color 161	W161 (1)	X161 (2)	—	—
YA4CA-	#4 AWG	1	Green 375	X4CART (3)	X4CART (3)	1 Crimp	2 Crimps
			No Color 162	W162 (3)	—	—	—
YA2CA-	#2 AWG	1-1/4	Pink 348	X2CART (4)	X2CART (4)	2 Crimps	2 Crimps
			No Color 163	W163 (3)	—	—	—
			No Color 239	W239 (2)	X239 (4)	—	—
YA1CA-	#1 AWG	1-1/16	Gold 471	X1CART (3)	X1CART (3)	2 Crimps	2 Crimps
			No Color 163	W163 (3)	—	—	—
YA25A-	1/0 AWG	1-3/16	Tan 296	X25ART (4)	X25ART (4)	2 Crimps	2 Crimps
			No Color 241	W241 (2)	X241 (4)	—	—
YA26A-	2/0 AWG	1-3/8	Olive 297	X26ART (4) WBG (2)	X26ART (4) XBG (4)	2 Crimps	3 Crimps
			No Color 245	W245 (3)	X245 (4)	—	—
YA27A-	3/0 AWG	1-1/2	Ruby 467	X27ART (4)	X27ART (4)	2 Crimps	3 Crimps
			No Color 166	W166 (4)	—	—	—
YA28A-	4/0 AWG	1-5/8	White 298	X28ART (6)	X28ART (6)	2 Crimps	3 Crimps
			No Color 660	W660 (3)	X660 (8)	—	—
YA29A-	250 kcmil	1-5/8	Red 324	—	—	—	—
YA30A-	300 kcmil	1-3/4	Blue 470	—	—	—	—
YA31A-	350 kcmil	2-1/8	Brown 299	W31ART (4)	—	—	—
YA32A-	400 kcmil	2-1/2	Green 472	—	—	—	—
YA34A-	500 kcmil	2-5/8	Pink 300	—	—	—	—
YA36A-	600 kcmil	2-7/8	Black 473	—	—	—	—
YA39A-	700 - 750 kcmil	2-7/8	Yellow 936	—	—	—	—
YA40A-	800 kcmil	3	Gray 474	—	—	—	—
YA42A-	900 AL kcmil	2-7/8	Gray 303	—	—	—	—
YA44A-	1000 kcmil	3-1/8	Brown 302*	—	—	—	—
YA45A-	1250 kcmil	3-1/8	Brown 302*	—	—	—	—
YA46A-	1500 kcmil	3-3/4	Blue 478	—	—	—	—
YA47A-	1750 kcmil	4-3/8	White 587	—	—	—	—
YA48A-	2000 kcmil	4-1/8	Red 479	—	—	—	—

*Index 302 recommended for 1.84 O.D. barrel

Compression Connections

Type YA-A Installation Tooling Table
for Aluminum Terminals Hydraulic (Requiring Dies)

Catalog Number Type	Wire / Conductor Size	Wire Strip Length	Color Code Die Index	Hydraulic Tools - Dies Required (# Crimps)				
	Class B, C (AL/CU)			MD6, 600, 500 Series	750, 35 Series	45 Series Use PT6515 with U Dies	46 Series Use PUADP1 with U Dies	60 Series
YA8CA-	#8 AWG	5/8	Blue 374	X8CART (2) W374 (1)	U8CABT (1)	U8CABT (1)	U8CABT (1)	—
YA6CA-	#6 AWG	3/4	Gray 346	X6CART (2)	U6CABT (1)	U6CABT (1)	U6CABT (1)	—
			No Color 161	W161 (1) X161 (2)	—	—	—	—
YA4CA-	#4 AWG	1	Green 375	X4CART (3)	U4CABT (1)	U4CABT (1)	U4CABT (1)	—
			No Color 162	W162 (3)	—	—	—	—
YA2CA-	#2 AWG	1-1/4	Pink 348	X2CART (4)	U2CABT (1)	U2CABT (1)	U2CABT (1)	—
			No Color 163	W163 (3)	—	—	—	—
			No Color 239	W239 (2) X239 (4)	—	—	—	—
YA1CA-	#1 AWG	1-1/16	Gold 471	X1CART (3)	U1CART (1)	U1CART (1)	U1CART (1)	—
			No Color 163	W163 (3)	—	—	—	—
YA25A-	1/0 AWG	1-3/16	Tan 296	X25ART (4)	U25ART (1)	U25ART (1)	U25ART (1)	—
			No Color 241	X241 (2)	—	—	—	—
YA26A-	2/0 AWG	1-3/8	Olive 297	X26ART (4) WBG (2)	U26ART (2)	U26ART (2)	U26ART (2)	—
			No Color 245	W245 (3) X245 (4)	—	—	—	—
YA27A-	3/0 AWG	1-1/2	Ruby 467	X27ART (4)	U27ART (2)	U27ART (2)	U27ART (2)	—
			No Color 166	W166 (4)	—	—	—	—
YA28A-	4/0 AWG	1-5/8	White 298	X28ART (6)	U28ART (2)	U28ART (2)	U28ART (2)	L28ART (1)
			No Color 660	W660 (3) X660 (8)	—	—	—	—
YA29A-	250 kcmil	1-5/8	Red 324	—	U29ART (2)	U29ART (2)	U29ART (2)	L29ART (1)
YA30A-	300 kcmil	1-3/4	Blue 470	—	U30ART (2)	U30ART (2)	U30ART (2)	L30ART (1)
YA31A-	350 kcmil	2-1/8	Brown 299	W31ART (4)	U31ART (2)	U31ART (2)	U31ART (2)	L31ART (1)
YA32A-	400 kcmil	2-1/2	Green 472	—	U32ART (4)	U32ART (4)	U32ART (4)	L32ART (2)
YA34A-	500 kcmil	2-5/8	Pink 300	—	U34ART (4)	U34ART (4)	U34ART (4)	L34ART (2)
YA36A-	600 kcmil	2-7/8	Black 473	—	U36ART (4)	U36ART (4)	U36ART (4)	L36ART (2)
YA39A-	700 - 750 kcmil	2-7/8	Yellow 936	—	U39ART2 (4)	U39ART2 (4)	U39ART2 (4)	L39ART2 (2)
YA40A-	800 kcmil	3	Gray 474	—	—	S40ART (4)	P40ART (4)	L40ART (2)
YA42A-	900 AL kcmil	2-7/8	Gray 303	—	—	U42ART (4)	U42ART (4)	—
YA44A-	1000 kcmil	3-1/8	Brown 302*	—	—	S44ART (4)	P44ART (4)	L44ART (2)
YA45A-	1250 kcmil	3-1/8	Brown 302*	—	—	S44ART (4)	P44ART (4)	L44ART (2)
YA46A-	1500 kcmil	3-3/4	Blue 478	—	—	—	—	L46ART (2)
YA47A-	1750 kcmil	4-3/8	White 587	—	—	—	—	L47ART (2)
YA48A-	2000 kcmil	4-1/8	Red 479	—	—	—	—	L48ART (2)

*Index 302 recommended for 1.84 O.D. barrel

Catalog Number Type	Wire / Conductor Size		Wire Strip Length	Color Code Die Index	Hydraulic Tools - Dieless # Crimps			
	Class B, C (AL/CU)	Copper Clad Aluminum (CCA) <i>Only for use with 644/444S Series</i>			81K, 4PC Series	644 Series	444S Series	Y644MBH Remote Head
YA8CA-	#8 AWG	—	5/8	Blue 374	1 Crimp	—	—	—
YA6CA-	#6 AWG	—	3/4	Gray 346	1 Crimp	1 Crimp	—	1 Crimp
				No Color 161	—	—	—	—
YA4CA-	#4 AWG	—	1	Green 375	1 Crimp	1 Crimp	1 Crimp	1 Crimp
				No Color 162	—	—	—	—
YA2CA-	#2 AWG	—	1-1/4	Pink 348	2 Crimps	1 Crimp	1 Crimp	1 Crimp
				No Color 163	—	—	—	—
				No Color 239	—	—	—	—
YA1CA-	#1 AWG	—	1-1/16	Gold 471	2 Crimps	1 Crimp	1 Crimp	1 Crimp
				No Color 163	—	—	—	—
YA25A-	1/0 AWG	—	1-3/16	Tan 296	2 Crimps	1 Crimp	1 Crimp	1 Crimp
				No Color 241	—	—	—	—
YA26A-	2/0 AWG	—	1-3/8	Olive 297	2 Crimps	1 Crimp	1 Crimp	1 Crimp
				No Color 245	—	—	—	—
YA27A-	3/0 AWG	—	1-1/2	Ruby 467	2 Crimps	1 Crimp	1 Crimp	1 Crimp
				No Color 166	—	—	—	—
YA28A-	4/0 AWG	—	1-5/8	White 298	2 Crimps	1 Crimp	1 Crimp	1 Crimp
				No Color 660	—	—	—	—
YA29A-	250 kcmil	—	1-5/8	Red 324	2 Crimps	1 Crimp	1 Crimp	1 Crimp
YA30A-	300 kcmil	4/0 AWG CCA DLO (329/22)	1-3/4	Blue 470	2 Crimps	1 Crimp	1 Crimp	1 Crimp
YA31A-	350 kcmil	250 kcmil CCA DLO (399/22)	2-1/8	Brown 299	3 Crimps	1 Crimp	1 Crimp	1 Crimp
YA32A-	400 kcmil	—	2-1/2	Green 472	4 Crimps	1 Crimp	1 Crimp	1 Crimp
YA34A-	500 kcmil	350 kcmil CCA DLO (779/22)	2-5/8	Pink 300	4 Crimps	1 Crimp	1 Crimp	1 Crimp
YA36A-	600 kcmil	500 kcmil CCA DLO (779/22)	2-7/8	Black 473	4 Crimps	1 Crimp	1 Crimp	1 Crimp
YA39A-	700 - 750 kcmil	600 kcmil CCA DLO (925/22)	2-7/8	Yellow 936	4 Crimps	1 Crimp	1 Crimp	1 Crimp
YA40A-	800 kcmil	—	3	Gray 474	—	1 Crimp	1 Crimp	1 Crimp
YA42A-	900 AL kcmil	—	2-7/8	Gray 303	—	2 Crimps	2 Crimps	2 Crimps
YA44A-	1000 kcmil	750 kcmil CCA DLO (1184/22) 800 kcmil CCA DLO (1258/22)	3-1/8	Brown 302*†	—	—	1 Crimp	1 Crimp
YA45A-	1250 kcmil	900 kcmil CCA DLO (1406/22) 1000 kcmil CCA DLO (1554/22)	3-1/8	Brown 302*†	—	—	—	—
YA46A-	1500 kcmil	—	3-3/4	Blue 478	—	—	—	—
YA47A-	1750 kcmil	—	4-3/8	White 587	—	—	—	—
YA48A-	2000 kcmil	—	4-1/8	Red 479	—	—	—	—

*Index 302 recommended for 1.84 O.D. barrel

†Index 302 in dieless tools can only be crimped with 444S Series, Y644MBH, or Y644MBHF tools

Installation Instructions

Installation instructions help the installer understand proper wire preparation, proper insertion requirements, crimp zone location, individual crimp location, crimp order and crimp direction, to ensure safe and reliable wire connections. In order to obtain a UL Listing BURNDY certifies its products using the BURNDY Engineered System and select other crimp tool manufacturers in accordance with one or more UL categories.

Aluminum Installation Steps:

- Select the appropriate connector based on:
 - Wire Material
 - Wire Construction
 - Wire Size
- Strip the insulation to the appropriate wire strip length, based on the table's Wire Strip Length recommendation for the selected connector. Due to tolerances in the connector, wire strip length, and insulation stripping tools, this range may be 0" - 1/4". The exposed wire, also known as a "shiner", has no performance impact on the connection and there is no wire exposure requirement by BURNDY.
- Wire brush the bare conductor to remove any oxides. DO NOT wire brush tin-plated connectors.
- Apply PENETROX™ A13 oxide inhibitor to the bare conductor.
- Insert the conductor into the barrel for the full length. The connector barrel is filled with PENETROX™ A13, so be aware of the following:
 - Oxide inhibitor may discharge from the barrel when wire is fully inserted.
 - Oxide inhibitor may cause resistance that could feel like the wire is fully inserted. Ensure you insert the wire with enough force to penetrate the oxide inhibitor barrier until you reach the full wire insertion distance.
- Apply the proper number of crimps based on the installation tooling requirements. Use the illustrations as a guide on crimp placement and direction for the proper number of crimps.
- Remove excess PENETROX™ A13 that may discharge during installation.

*For simplicity, the images show a 1-hole connector, however, connectors are available in 1-hole, 2-hole or more hole patterns.

CATALOG NUMBER DESIGNATIONS

YA8CA-	YA6CA-	YA4CA-	YA2CA-	YA1CA-	YA25A-
--------	--------	--------	--------	--------	--------

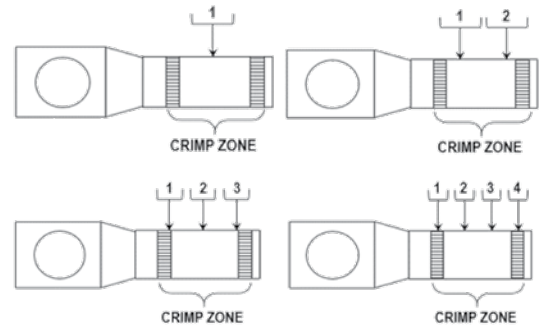

CATALOG NUMBER DESIGNATIONS

YA26A-	YA27A-	YA28A-	YA29A-	YA30A-	YA31A-
YA39AM-	YA40A-	YA44A-	YA45A-	YA46A-	YA48A-

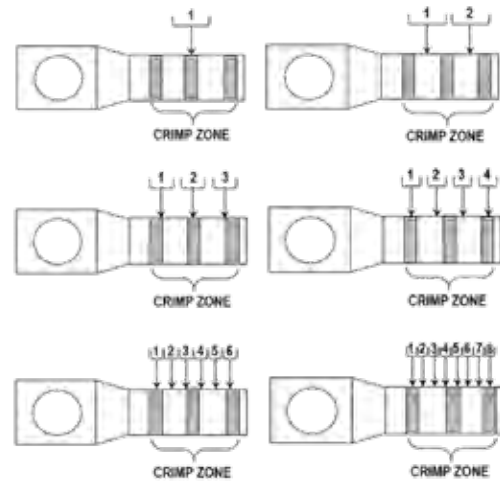

CATALOG NUMBER DESIGNATIONS

YA32A-	YA34A-	YA36A-	YA39A-	YA42A-
--------	--------	--------	--------	--------

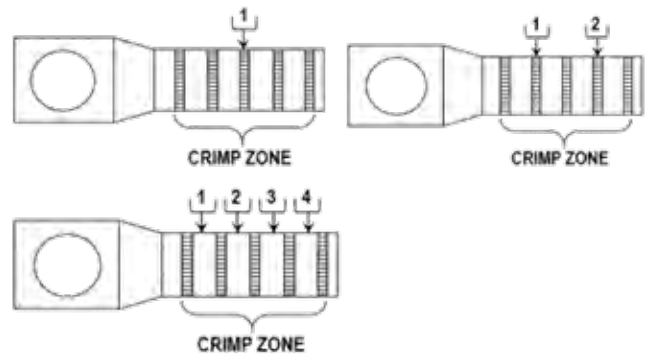

TYPE YAAKIT

Transformer Lug Kit



CONNECTOR

Each kit contains the UL Listed and CSA Certified AL9CU rated aluminum compression connectors and tongue mounting hardware needed to terminate aluminum or copper cables in "dry type" transformers. The KVA rating gives an approximate cross reference to the appropriate kit.

▲ See Type YA-A Installation Tooling Table for Aluminum Terminals in this section for complete tool and die listing information.

Features & Benefits

- UL Listed AL9CU dual rated compression terminals and CSA Certified; ensure the transformer feeders and taps are terminated properly
- Plated steel cap screws and hex nuts with captive conical washers or individual belleville washers
- Terminal to bus connections are made using proper hardware resulting in true torque to pressure performance, compensates for dissimilar metal expansion and contraction
- Hardware packed in plastic bag; no lost hardware prior to installation
- Conductor Accommodate Types:
 - Aluminum Code Wire: Class B (Concentric, Compressed, Compact)
 - Copper Code Wire: Class B (Concentric, Compressed, Compact or Class C)
 - Copper Clad Aluminum: Noted in the conductor accommodates as CCA



NOTE: Field bending straight lugs to achieve an angular connection will void UL Listing / CSA Certifications and BURNDY will not be liable for the connection.

Accessories

- Hardware - Section F
- PENETROX™ Oxide Inhibitor - Section F
- Heat and Cold Shrink Tubing - Section D
- WIREMIKE™ Wire Micrometer - Section F
- Wire Management (Cable Ties) - Section G

Catalog Number	KVA	Terminals		Wire Range with 644 Series	Bolt		Hardware		Washer	
		Qty.	Cat. No.		Qty.	Size	Qty.	Nut	Qty.	Type
YAAKIT1	15-37.5 1Ø	8	YA2C-A5	#6-2 AWG	8	1/4-20 X 3/4	8	1/2 x 20HN	Captive	
	15-45.3 3Ø	4	YA30-A7	2/0 AWG-300 kcmil	8	1/4-20 X 3/4	8	1/2 x 20HN	Captive	
YAAKIT2	50-75 1Ø	12	YA30-A7	2/0 AWG-300 kcmil	8	1/4-20 X 3/4	16	1/4 X 20HN	Captive	
	75-112.5 3Ø	12	YA30-A7	2/0 AWG-300 kcmil	8	1/4-20 X 2	16	1/4 X 20HN	Captive	
YAAKIT3	100-167 1Ø	3	YA30-A7	2/0 AWG-300 kcmil	3	1/4-20 X 3/4	3	1/4 X 20	Captive	
	150-300 3Ø	22	YA39-A1	500-750 kcmil	16	1/2-13 X 2	16	1/2-13	16	1/2" Belleville

HH- Hex Head

HN- Hex Nut

See Mechanical section for set screw terminal kits.

Note: All dimensions shown are for reference only.

TYPE YAV-M

HYLUG™

Uninsulated Copper Compression Terminal
Rated for 90° C, Up to 35 kV ♦

Made from electrolytic copper tube and is electro-tin plated. Wire range is from 2.5 mm² to 630 mm² Class 2. Compatible to IEC61238-1.

NOTE: Field bending straight lugs to achieve an angular connection will void UL Listing / CSA Certifications and BURNDY will not be liable for the connection.

Features & Benefits

- Inspection window allows for visual verification that the wire has been fully inserted prior to crimping the lug
- Barrel is designed with an internal chamfer at the wire entry to ensure smooth insertion of the wire, preventing possible damaging of the wire strands during installation
- Short/standard length barrel is recommended for installation with limited space requirements
- Electro-tin plated unless specified to reduce galvanic corrosion (bimetallic) and resist corrosive elements
- Compatible Standards: IEC61238-1, UL 486A-486B, CSA-C22.2 No. 65-03
- Connectors are clearly marked with stamping
- Terminals and splices accommodating code wire: Accommodates Code Class B (Concentric, Compressed, Compact) and Class C wire

Accessories

- Hardware - Section F
- PENETROX™ Oxide Inhibitor - Section F
- Heat and Cold Shrink Tubing - Section D
- WIREMIKE™ Wire Micrometer - Section F
- Wire Management (Cable Ties) - Section G

Electro-Tin
Plated

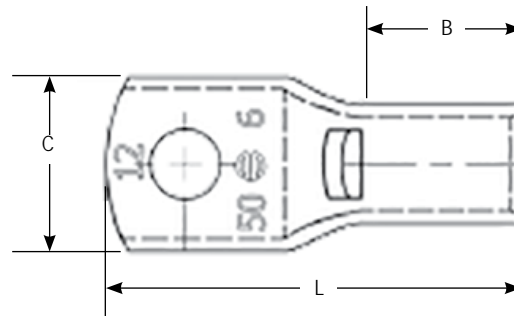
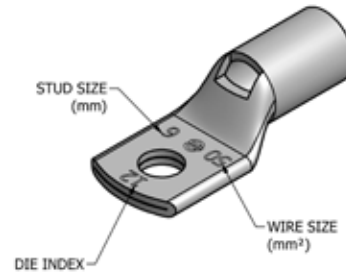

TYPE YAV-M (Continued)

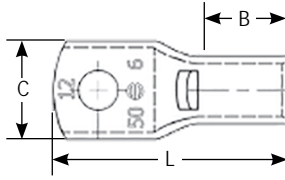

Electro-Tin
Plated

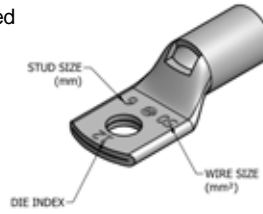

NOTE: Field bending straight lugs to achieve an angular connection will void UL Listing / CSA Certifications and BURNDY will not be liable for the connection.

Catalog Number	Copper		Stud Size	Dimensions (mm)				Installation Tooling					Wire Strip Length
	Wire Range mm ² (AWG)	Class		(B)	(C)	(L)	Tongue Thickness	Dieless	MD6, OUR840, MD734R	500 Series	35, 750, 46** Series	Die Index	
YAV025M3	1.5 - 2.5 (20 - 14)	2, 5	M3	6.7	7.9	19.1	1.0	Y10D (1) Y1022 (1) MR8G98 (1) MR89Q (1) Y8MRB1 (1) MR20 (1)	—	—	—	—	7
YAV025M4			M4	6.7	7.9	19.1	1.0						
YAV025M5			M5	6.7	7.9	19.1	1.0						
YAV025M6			M6	6.7	10.7	24.2	0.8						
YAV025M8			M8	6.7	11.0	24.2	0.8						
YAV06M35	4 - 6 (12 - 10)	2, 5	M3.5	10.5	7.6	23.7	1.8	Y1MRTC (1) MY2911 (1) MRC840 (1) 81K Series (1)	—	—	—	—	11
YAV06M4			M4	10.4	9.5	23.9	1.5						
YAV06M5			M5	10.4	9.5	23.9	1.5						
YAV06M6			M6	10.4	11.9	26.9	1.3						
YAV06M8			M8	10.4	13.5	28.7	1.0						
YAV06M10	M10	9.5	14.2	31.0	1.0								
YAV10M4	10 (8)	2, 5	M4	11.2	10.4	29.1	2.0	Y1MRTC (1) MY2911 (1) MRC840 (1) 81K Series (1)	W8CVT (1) W8CRT (1) X8CRT (1)	W8CVT (1) W8CRT (1) X8CRT (1)	U8CRT (1)	49	11
YAV10M5			M5	11.2	10.4	28.5	1.8						
YAV10M6			M6	11.2	1.0	31.0	1.8						
YAV10M8			M8	11.2	13.2	33.0	1.5						
YAV10M10			M10	11.2	14.5	33.0	1.3						
YAV10M12	M12	11.2	18.5	38.6	1.3								
YAV16M4	16 (6)	2, 5	M4	12.7	12.2	31.5	2.3	Y1MRTC (1) MY2911 (1) MRC840 (1) 81K Series (1)	W5CVT (1) W5CRT (1) X5CRT (1)	W5CVT (1) W5CRT (1) X5CRT (1)	U5CRT (1)	7	13
YAV16M5			M5	12.7	12.2	33.0	2.0						
YAV16M6			M6	12.7	12.2	33.0	2.0						
YAV16M8			M8	12.7	15.2	36.3	1.5						
YAV16M10			M10	12.7	14.7	40.9	1.5						
YAV16M12	M12	12.7	18.8	41.6	1.3								
YAV25M5	25 (4)	2, 5	M5	12.7	14.0	33.5	2.3	Y1MRTC (2) MY2911 (1) MRC840 (1) 644 Series (1) 444 Series (1) 81K Series (1)	W3CRT (1)	W3CRT (1)	U3CRT (1)	9	13
YAV25M6			M6	12.7	12.7	34.5	2.0						
YAV25M8			M8	12.7	16.0	37.6	2.0						
YAV25M10			M10	12.7	14.7	41.4	2.0						
YAV25M12			M12	12.7	18.5	42.7	1.5						
YAV35M5	35 (2)	2, 5	M5	16.0	17.3	38.1	2.5	MY2911 (1) MRC840 (2) 644 Series (1) 444 Series (1) 81K Series (1)	W2CVT (1) W2CRT (1) X2CRT (1)	W2CVT (1) W2CRT (1) X2CRT (1)	U2CRT (1)	10	17
YAV35M6			M6	11.7	17.3	43.7	2.5						
YAV35M8			M8	11.7	17.3	43.7	2.5						
YAV35M10			M10	11.7	17.3	45.9	2.5						
YAV35M12			M12	11.7	19.6	47.5	2.3						
YAV35M16	M16	11.7	21.1	58.7	3.0								
YAV50M5	50 (2)	2	M5	16.0	17.3	38.1	2.5	MY2911 (1) MRC840 (2) 644 Series (1) 444 Series (1) 81K Series (1)	W25VT (2) W25RT (2) X25RT (2)	W25VT (2) W25RT (2) X25RT (2)	U25RT (1)	12	17
YAV50M6			M6	16.0	17.3	38.1	2.5						
YAV50M8			M8	16.0	17.3	42.9	2.5						
YAV50M10			M10	16.0	17.3	45.9	2.5						
YAV50M12			M12	16.0	18.5	52.3	2.5						
YAV50M14			M14	16.0	21.1	53.3	3.0						
YAV50M16	M16	16.0	25.9	58.7	3.6								

* Use equivalent AWG setting on tool for installation

** PUADP1 Adaptor is required to use U Dies in 46 Series

† P-RT Die sets for use in 46 Series tools only, PUADP1 Adaptor not required

Compression Connections

Copper Compression — Terminal — Code — One Hole
Standard Barrel — Metric Lugs — with Inspection Window

TYPE YAV-M (Continued)

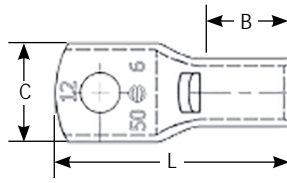

Electro-Tin
Plated

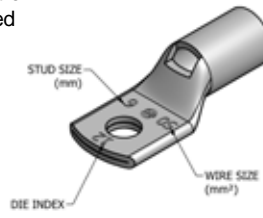

NOTE: Field bending straight lugs to achieve an angular connection will void UL Listing / CSA Certifications and BURNDY will not be liable for the connection.

Catalog Number	Copper		Stud Size	Dimensions (mm)				Installation Tooling					Wire Strip Length
	Wire Range mm ² (AWG)	Class		(B)	(C)	(L)	Tongue Thickness	Dieless	MD6, OUR840, MD734R	500 Series	35, 750, 46** Series	Die Index	
YAV70M5	70 (1/0)	2	M5	17.5	21.1	41.4	3.0	MY2911 (1) MRC840 (2) 644 Series (1) 444 Series (1) 81K Series (1)	W26VT (2) W26RT (2) X26RT (2)	W26VT (2) W26RT (2) X26RT (2)	U26RT (1)	13	19
YAV70M6			M6	17.5	21.1	44.5	3.0						
YAV70M8			M8	17.5	21.1	46.0	3.0						
YAV70M10			M10	17.5	21.1	49.3	3.0						
YAV70M12			M12	17.5	21.1	55.6	3.0						
YAV70M14			M14	17.5	22.4	56.6	2.8						
YAV70M16			M16	17.5	22.4	62.0	2.8						
YAV95M6	95 (2/0)	2	M6	20.6	23.6	45.8	3.3	MY2911 (1) MRC840 (2) 644 Series (1) 444 Series (1) 81K Series (2)	W27VT (2) W27RT (2) X27RT (3)	W27VT (2) W27RT (2) X27RT (3)	U27RT (1)	14	22
YAV95M8			M8	20.6	23.6	50.3	3.3						
YAV95M10			M10	20.6	23.6	53.6	3.3						
YAV95M12			M12	20.6	23.6	59.9	3.3						
YAV95M14			M14	20.6	23.6	61.0	3.3						
YAV95M16			M16	20.6	23.6	66.3	3.3						
YAV95M20			M20	20.6	30.5	77.4	4.1						
YAV120M6	120 (4/0)	2	M6	26.2	29.0	53.6	3.8	MY2911 (1) MRC840 (2) 644 Series (1) 444 Series (1) 81K Series (2)	W28VT (2) W28RT (2) X28RT (2)	W28VT (2) W28RT (2) X28RT (2)	U28RT (1)	15	27
YAV120M8			M8	26.2	29.0	58.2	3.8						
YAV120M10			M10	26.2	29.0	61.5	3.8						
YAV120M12			M12	26.2	29.0	67.8	3.8						
YAV120M14			M14	26.2	29.0	68.8	3.8						
YAV120M16			M16	26.2	29.0	74.2	3.8						
YAV120M20			M20	26.2	29.0	85.2	3.8						
YAV150M8	150 (300)	2	M8	26.2	30.5	58.7	4.1	644 Series (1) 444 Series (1) 81K Series (2)	W30VT (2)	W30VT (2) W30RT (2)	U30RT (2)	17	27
YAV150M10			M10	26.2	30.5	62.0	4.1						
YAV150M12			M12	26.2	30.5	68.3	4.1						
YAV150M14			M14	26.2	30.5	69.2	4.1						
YAV150M16			M16	26.2	30.5	74.7	4.1						
YAV150M20			M20	26.2	30.5	85.7	4.1						
YAV185M8	185 (350)	2	M8	26.9	32.8	60.2	4.6	644 Series (1) 444 Series (1) 81K Series (2)	W31VT (2)	W31VT (2) W31RT (2)	U31RT (2)	18	29
YAV185M10			M10	26.9	32.8	63.5	4.3						
YAV185M12			M12	26.9	32.8	69.9	4.3						
YAV185M14			M14	26.9	32.8	70.8	4.6						
YAV185M16			M16	26.9	32.8	76.2	4.6						
YAV185M20	M20	26.9	32.8	87.3	4.6								
YAV240M10	240 (500)	2	M10	32.3	39.4	72.9	5.8	644 Series (1) 444 Series (1) 81K Series (2)	W34VT (2)	W34VT (2) W34RT (2)	U34RT (2)	20	33
YAV240M12			M12	32.3	39.4	80.2	5.6						
YAV240M14			M14	32.3	39.4	81.3	5.8						
YAV240M16			M16	32.3	39.4	85.6	5.8						
YAV240M20	M20	32.3	39.4	96.6	5.8								
YAV300M10	300 (600)	2	M10	35.1	44.2	77.2	6.9	644 Series (1) 444 Series (1) 81K Series (2)	—	—	U36RT (2)	22	35
YAV300M12			M12	35.1	44.2	83.6	6.6						
YAV300M14			M14	35.1	44.2	84.6	6.9						
YAV300M16			M16	35.1	44.2	89.9	6.9						
YAV300M20			M20	35.1	44.2	100.9	6.9						

* Use equivalent AWG setting on tool for installation

** PUADP1 Adaptor is required to use U Dies in 46 Series

† P-RT Die sets for use in 46 Series tools only, PUADP1 Adaptor not required

TYPE YAV-M (Continued)

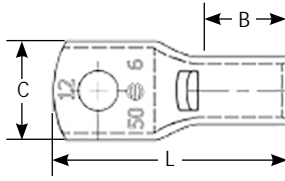

Electro-Tin
Plated



NOTE: Field bending straight lugs to achieve an angular connection will void UL Listing / CSA Certifications and BURNDY will not be liable for the connection.

Catalog Number	Copper		Stud Size	Dimensions (mm)				Installation Tooling					Wire Strip Length
	Wire Range mm² (AWG)	Class		(B)	(C)	(L)	Tongue Thickness	Dieless	MD6, OUR840, MD734R	500 Series	35, 750, 46** Series	Die Index	
YAV400M12	400 (800)	2	M12	36.1	50.3	87.1	7.6	644 Series (1) 444 Series (1) 81K Series (3)	—	—	U39RT (3)	24	37
YAV400M14			M14	36.1	50.3	88.1	7.6						
YAV400M16			M16	36.1	50.3	93.5	7.6						
YAV400M20			M20	36.1	50.3	104.5	7.6						
YAV500M12	500 (1000)	2	M12	41.9	55.6	96.2	8.1	—	—	—	U44XRT (3) •P44XRT (3)	L115	43
YAV500M16			M16	41.9	55.6	102.6	8.4						
YAV500M20			M20	41.9	55.6	113.7	8.4						
YAV630M12	630 (1250)	2	M12	50.8	62.5	107.7	9.7	—	—	—	P45RT (3)	29	55
YAV630M16			M16	50.8	62.5	114.0	9.7						
YAV630M20			M20	50.8	62.5	125.2	9.7						

* Use equivalent AWG setting on tool for installation

** PUADP1 Adaptor is required to use U Dies in 46 Series

† P-RT Die sets for use in 46 Series tools only, PUADP1 Adaptor not required

TYPE YAV-2M

HYLUG™

Rated for 90° C, Up to 35 kV ◆

Made from electrolytic copper tube and is electro-tin plated. Wire range is from 2.5 mm² to 630 mm² Class 2. Compatible to IEC61238-1.

NOTE: Field bending straight lugs to achieve an angular connection will void UL Listing / CSA Certifications and BURNDY will not be liable for the connection.

Electro-Tin
Plated



Features & Benefits

- Inspection window allows for visual verification that the wire has been fully inserted prior to crimping the lug; not recommended in highly corrosive environments as the wire in the barrel is exposed to corrosive elements installed
- Barrel is designed with an internal chamfer at the wire entry to ensure smooth insertion of the wire, preventing possible damaging of the wire strands during installation
- Short/standard length barrel is recommended for installations with limited space requirements and meet the exact UL testing requirements as long barrel connectors so performance of the connection is not compromised
- Two hole tongue/tang is recommended when space permits as the 2-hole feature minimizes the terminations from loosening or rotating under vibration, movement, or heat cycling
- Electro-tin plated unless specified to reduce galvanic corrosion (bimetallic) and resist corrosive elements
- Compatible Standards: IEC61238-1, UL 486A-486B, CSA-C22.2 No. 65-03
- Connectors are clearly marked with stamping
- Terminals and splices accommodating code wire: Accommodates Code Class B (Concentric, Compressed, Compact) and Class C wire

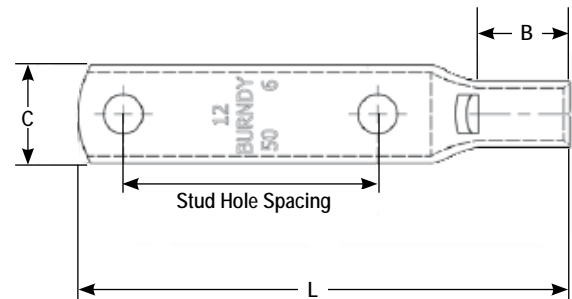

Accessories

- Hardware - Section F
- PENETROX™ Oxide Inhibitor - Section F
- Heat and Cold Shrink Tubing - Section D
- WIREMIKE™ Wire Micrometer - Section F
- Wire Management (Cable Ties) - Section G

TYPE YAV-2M (Continued)

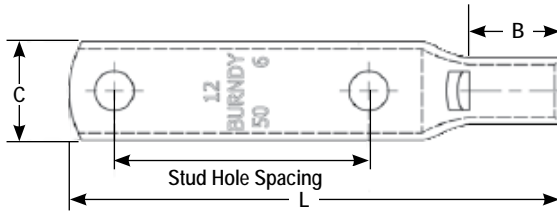

Electro-Tin
Plated



NOTE: Field bending straight lugs to achieve an angular connection will void UL Listing / CSA Certifications and BURNDY will not be liable for the connection.

Catalog Number	Wire Range (MM ²)	Stud Size	Stud Hole Spacing	Dimensions (mm)				Installation Tooling					Wire Strip Length (mm)
				Tongue Width	(B)	(C)	(L)	Dieless	MD6, OUR840, MD734R	500 Series	35, 750, 46** Series	Die Index	
YAV0252M3	2.5	M3	25.4	1	170.2	200.7	44.7	Y10D (1)	—	—	—	—	7
YAV0252M4		M4	25.4	1	170.2	200.7	44.7	Y1022 (1)					
YAV0252M5		M5	25.4	1	170.2	200.7	44.7	MR8G98 (1)					
YAV0252M6		M6	25.4	0.8	170.2	271.8	49.8	MR89Q (1)					
YAV0252M8	6	M8	25.4	0.8	170.2	279.4	49.8	Y8MRB1 (1)	—	—	—	11	
YAV062M4		M4	25.4	1.5	264.2	241.3	49.5	MR20 (1)					
YAV062M5		M5	25.4	1.5	264.2	241.3	49.5	Y10D (1)					
YAV062M6		M6	25.4	1.3	264.2	302.3	52.6	Y1022 (1)					
YAV062M8	10	M8	25.4	1	264.2	342.9	53.3	MR8G98 (1)	—	—	—	11	
YAV062M10		M10	25.4	1	302.3	360.7	54.6	MR89Q (1)					
YAV102M4		M4	44.5	0	284.5	264.2	73.4	Y8MRB1 (1)					
YAV102M5		M5	44.5	0	284.5	264.2	74.9	MR20 (1)					
YAV102M6	16	M6	44.5	0	284.5	297.2	78.2	Y1MRTC (1)	W8CVT (1)	W8CVT (1)	U8CRT (1)	49	11
YAV102M8		M8	44.5	0	284.5	335.3	79.8	MY2911 (1)					
YAV102M10		M10	44.5	0	284.5	348	83.1	MRC840 (1)					
YAV102M12		M12	44.5	0	284.5	469.9	89.4	81K Series (1)					
YAV162M4	25	M4	44.5	2	322.6	309.9	76.2	Y1MRTC (1)	W5CVT (1)	W5CVT (1)	U5CRT (1)	7	13
YAV162M5		M5	44.5	2	322.6	309.9	77.7	MY2911 (1)					
YAV162M6		M6	44.5	2	322.6	309.9	80.8	MRC840 (1)					
YAV162M8		M8	44.5	1.5	322.6	386.1	82.6	81K Series (1)					
YAV162M10	35	M10	44.5	1.5	322.6	373.4	85.6	Y1MRTC (2)	W3CRT (1)	W3CRT (1)	U3CRT (1)	9	13
YAV162M12		M12	44.5	1.3	322.6	477.5	91.9	MY2911 (1)					
YAV252M5		M5	44.5	2	322.6	355.6	78.2	MRC840 (1)					
YAV252M6		M6	44.5	2	322.6	322.6	81.3	644 Series (1)					
YAV252M8	50	M8	44.5	2	322.6	406.4	83.1	444 Series (1)	W2CVT (1)	W2CVT (1)	U2CRT (1)	10	17
YAV252M10		M10	44.5	2	322.6	373.4	86.1	81K Series (1)					
YAV252M12		M12	44.5	1.5	322.6	469.9	92.5	MY2911 (1)					
YAV352M5		M5	44.5	2.5	406.4	439.4	85.9	MRC840 (1)					
YAV352M6	70	M6	44.5	2.5	406.4	439.4	87.6	W2CRT (1)	W2CVT (1)	W2CVT (1)	U2CRT (1)	12	17
YAV352M8		M8	44.5	2.5	406.4	439.4	90.7	W2CRT (1)					
YAV352M10		M10	44.5	2.5	406.4	439.4	90.7	X2CRT (1)					
YAV352M12		M12	44.5	2.5	406.4	439.4	97	MY2911 (1)					
YAV502M6	81K Series (1)	M6	44.5	2.5	406.4	439.4	85.9	MY2911 (1)	W25VT (2)	W25VT (2)	U25RT (1)	12	17
YAV502M8		M8	44.5	2.5	406.4	439.4	87.6	MRC840 (2)					
YAV502M10		M10	44.5	2.5	406.4	439.4	90.7	644 Series (1)					
YAV502M12		M12	44.5	2.5	406.4	469.9	97	444 Series (1)					
YAV502M14	81K Series (1)	M14	44.5	3	406.4	535.9	98	81K Series (1)	W25RT (2)	W25RT (2)	U25RT (1)	12	17
YAV502M16		M16	44.5	3	406.4	657.9	103.4	81K Series (1)					
YAV702M6		M6	44.5	3	444.5	535.9	89.2	MY2911 (1)					
YAV702M8		M8	44.5	3	444.5	535.9	90.7	MRC840 (2)					
YAV702M10	81K Series (1)	M10	44.5	3	444.5	535.9	94	644 Series (1)	W26VT (2)	W26VT (2)	U26RT (1)	13	19
YAV702M12		M12	44.5	3	444.5	535.9	100.3	644 Series (1)					
YAV702M14		M14	44.5	2.8	444.5	569	101.3	444 Series (1)					
YAV702M16		M16	44.5	2.8	444.5	569	106.7	81K Series (1)					

* Use equivalent AWG setting on tool for installation.

** PUADP1 Adaptor is required to use U Dies in 46 Series tools.

† P-RT Die sets for use in 46 Series only, PUADP1 Adaptor not required.

Compression Connections

Copper Compression — Terminal — Code — Two Hole
Standard Barrel — Metric Lugs — with Inspection Window

TYPE YAV-2M (Continued)

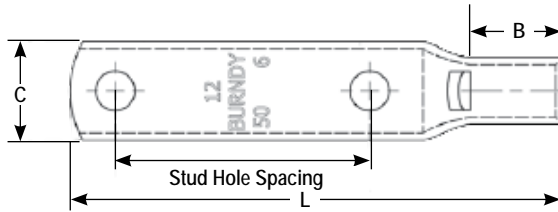

Electro-Tin
Plated



NOTE: Field bending straight lugs to achieve an angular connection will void UL Listing / CSA Certifications and BURNDY will not be liable for the connection.

Catalog Number	Wire Range (MM ²)	Stud Size	Stud Hole Spacing	Dimensions (mm)				Installation Tooling					Wire Strip Length (mm)
				Tongue Width	(B)	(C)	(L)	Dieless	MD6, OUR840, MD734R	500 Series	35, 750, 46** Series	Die Index	
YAV952M8	95	M8	44.5	3.3	523.2	599.4	95	MY2911 (1) MRC840 (2) 644 Series (1) 444 Series (1) 81K Series (2)	W27VT (2) W27RT (2) X27RT (3)	W27VT (2) W27RT (2) X27RT (3)	U27RT (1)	14	22
YAV952M10		M10	44.5	3.3	523.2	599.4	98.3						
YAV952M12		M12	44.5	3.3	523.2	599.4	104.6						
YAV952M14		M14	44.5	3.3	523.2	599.4	105.7						
YAV952M16		M16	44.5	3.3	523.2	599.4	111						
YAV952M20		M20	44.5	4.1	523.2	774.7	122.2						
YAV1202M8	120	M8	44.5	3.6	665.5	736.6	102.9	MY2911 (1) MRC840 (2) 644 Series (1) 444 Series (1) 81K Series (2)	W28VT (3) W28RT (3) X28RT (3)	W28VT (2) W28RT (2) X28RT (3)	U28RT (1)	15	27
YAV1202M10		M10	44.5	3.6	665.5	736.6	106.2						
YAV1202M12		M12	44.5	3.8	665.5	736.6	112.5						
YAV1202M14		M14	44.5	3.6	665.5	736.6	113.5						
YAV1202M16		M16	44.5	3.6	665.5	736.6	118.9						
YAV1202M20		M20	44.5	4.3	665.5	736.6	130						
YAV1502M8	150	M8	44.5	4.1	665.5	774.7	103.4	644 Series (1) 444 Series (1) 81K Series (2)	W30VT (2)	W30VT (2) W30RT (2)	U30RT (2)	17	27
YAV1502M10		M10	44.5	4.1	665.5	774.7	106.7						
YAV1502M12		M12	44.5	4.1	665.5	774.7	113						
YAV1502M14		M14	44.5	4.1	665.5	774.7	114						
YAV1502M16		M16	44.5	4.1	665.5	774.7	119.4						
YAV1502M20		M20	44.5	4.1	665.5	774.7	130.3						
YAV1852M8	185	M8	44.5	4.3	683.3	833.1	104.9	644 Series (1) 444 Series (1) 81K Series (2)	W31VT (2)	W31VT (2) W31RT (2)	U31RT (2)	18	29
YAV1852M10		M10	44.5	4.3	683.3	833.1	108.2						
YAV1852M12		M12	44.5	4.3	683.3	833.1	114.6						
YAV1852M14		M14	44.5	4.3	683.3	833.1	115.6						
YAV1852M16		M16	44.5	4.3	683.3	833.1	120.9						
YAV1852M20		M20	44.5	4.3	683.3	833.1	132.1						
YAV2402M10	240	M10	44.5	5.6	820.4	1000.8	117.6	644 Series (1) 444 Series (1) 81K Series (2)	W34VT (2)	W34VT (2) W34RT (2)	U34RT (2)	20	33
YAV2402M12		M12	44.5	5.6	820.4	1000.8	125						
YAV2402M14		M14	44.5	5.6	820.4	1000.8	125						
YAV2402M16		M16	44.5	5.6	820.4	1000.8	130.3						
YAV2402M20		M20	44.5	5.6	820.4	1000.8	141.2						
YAV3002M10		300	M10	44.5	6.6	175.3	1122.7						
YAV3002M12	M12		44.5	6.6	167.6	1122.7	128.3						
YAV3002M14	M14		44.5	6.6	175.3	1122.7	129						
YAV3002M16	M16		44.5	6.6	175.3	1122.7	134.6						
YAV3002M20	M20		44.5	6.6	175.3	1122.7	145.5						
YAV4002M14	400		M14	44.5	7.6	193	1277.6	132.8	644 Series (1) 444 Series (1) 81K Series (2)	—	—	U39RT (3)	24
YAV4002M16		M16	44.5	7.6	193	1277.6	138.2						
YAV4002M20		M20	44.5	7.6	193	1277.6	149.4						
YAV5002M16	500	M16	44.5	8.1	205.7	1412.2	147.3	644 Series (1) 444 Series (1) 81K Series (2)	—	—	U44XRT (3) † P44XRT (3)	L115	43
YAV5002M20		M20	44.5	8.1	205.7	1412.2	158.5						
YAV6302M16	630	M16	44.5	9.7	246.4	1587.5	158.8	644 Series (1) 444 Series (1) 81K Series (2)	—	—	† P45RT (3)	29	55
YAV6302M20		M20	44.5	9.7	246.4	1587.5	169.9						

* Use equivalent AWG setting on tool for installation.

** PUADP1 Adaptor is required to use U Dies in 46 Series tools.

† P-RT Die sets for use in 46 Series only, PUADP1 Adaptor not required.

TYPE YALB-M

HYLUG™

Rated for 90° C, Up to 35 kV ♦

Made from electrolytic copper tube and is electro-tin plated. Wire range is from 2.5 mm² to 630 mm² Class 2. Compatible to IEC61238-1.

NOTE: Field bending straight lugs to achieve an angular connection will void UL Listing / CSA Certifications and BURNDY will not be liable for the connection.

Features & Benefits

- No inspection window is ideal for more corrosive environments as the barrel transition is not open
- Barrel is designed with an internal chamfer at the wire entry to ensure smooth insertion of the wire, preventing possible damaging of the wire strands during installation
- Long barrel allows for an increased number of crimps which will increase the mechanical strength of the connection
- Electro-tin plated unless specified to reduce galvanic corrosion (bimetallic) and resist corrosive elements
- Compatible Standards: IEC61238-1, UL 486A-486B, CSA-C22.2 No. 65-03
- Terminals and splices accommodating code wire: Accommodates Code Class B (Concentric, Compressed, Compact) and Class C wire

Accessories

- Hardware - Section F
- PENETROX™ Oxide Inhibitor - Section F
- Heat and Cold Shrink Tubing - Section D
- WIREMIKE™ Wire Micrometer - Section F
- Wire Management (Cable Ties) - Section G

Electro-Tin
Plated

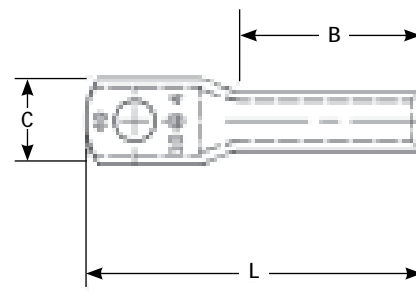
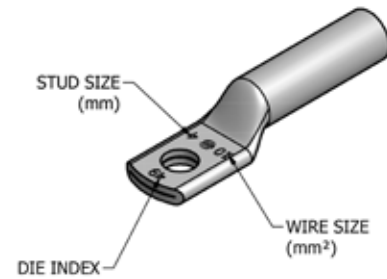

Compression Connections

Copper Compression — Terminal — Code — One Hole
Long Barrel — Metric Lugs — No Inspection Window

TYPE YALB-M (Continued)

NOTE: Field bending straight lugs to achieve an angular connection will void UL Listing / CSA Certifications and BURNDY will not be liable for the connection.

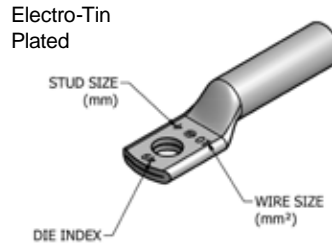
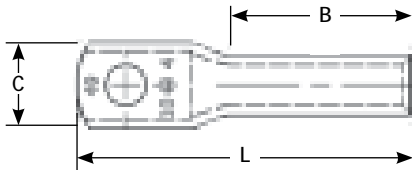

Catalog Number	Wire Range (MMF)	Stud Size	Dimensions (mm)				Installation Tooling					Wire Strip Length
			Tongue Thickness	(B)	(C)	(L)	Dieless	MD6, OUR840, MD734R	500 Series	35, 750, 46** Series	Die Index	
YALB10M4	10	M4	2.3	20.6	9.7	38.1	Y1MRTC (2) MY2911 (1) MRC840 (2) 81K Series (1)	W8CVT (2) W8CRT (2) X8CRT (2)	W8CVT (2) W8CRT (2) X8CRT (2)	U8CRT (2)	49	22
YALB10M5		M5	2	20.6	10.4	39.9						
YALB10M6		M6	2	20.6	11.2	42.9						
YALB10M8		M8	1.5	20.6	13.2	44.5						
YALB10M10		M10	1.5	20.6	14.7	47.8						
YALB10M12		M12	3	20.6	21.1	58.9						
YALB16M4	16	M4	2	28.4	11.4	47.2	Y1MRTC (2) MY2911 (2) MRC840 (2) 81K Series (1)	W5CVT (2) W5CRT (2) X5CRT (2)	W5CVT (2) W5CRT (2) X5CRT (2)	U5CRT (2)	7	30
YALB16M5		M5	2	28.4	11.4	48.8						
YALB16M6		M6	2	28.4	12.2	51.8						
YALB16M8		M8	1.8	28.4	13.2	53.6						
YALB16M10		M10	1.5	28.4	14.7	59.2						
YALB16M12		M12	3	28.4	19.1	63.0						
YALB25M5	25	M5	2.3	31.8	14	53.6	Y1MRTC (4) MY2911 (2) MRC840 (2) 81K Series (1)	W3CRT (2)	W3CRT (2)	U3CRT (2)	9	33
YALB25M6		M6	2.3	31.8	14	56.6						
YALB25M8		M8	2.3	31.8	14	58.4						
YALB25M10		M10	2	31.8	14.7	61.5						
YALB25M12		M12	3	31.8	21.1	67.8						
YALB35M5	35	M5	2.5	35.1	17.3	57.7	Y1MRTC (4) MY2911 (2) MRC840 (2) 644 Series (1) 444 Series (1) 81K Series (1)	W2CVT (2) W2CRT (2) X2CRT (2)	W2CVT (2) W2CRT (2) X2CRT (2)	U2CRT (2)	10	37
YALB35M6		M6	2.5	35.1	17.3	60.7						
YALB35M8		M8	2.5	35.1	17.3	62.2						
YALB35M10		M10	2.5	35.1	17.3	65.5						
YALB35M12		M12	3	35.1	21.1	71.9						
YALB50M6	50	M6	2.5	35.1	17.3	60.7	MY2911 (2) MRC840 (4) 644 Series (1) 444 Series (1) 81K Series (1)	W25VT (4) W25RT (4) X25RT (4)	W25VT (4) W25RT (4) X25RT (4)	U25RT (2)	12	40
YALB50M8		M8	2.5	35.1	17.3	62.2						
YALB50M10		M10	2.5	35.1	17.3	65.5						
YALB50M12		M12	3	35.1	21.1	71.9						
YALB50M14		M14	3	35.1	21.1	72.9						
YALB50M16		M16	3	35.1	21.1	78.2						
YALB70M6	70	M6	3	38.1	21.1	65.5	MY2911 (2) MRC840 (4) 644 Series (1) 444 Series (1) 81K Series (2)	W26VT (4) W26RT (4) X26RT (4)	W26VT (4) W26RT (4) X26RT (4)	U26RT (2)	13	40
YALB70M8		M8	3	38.1	21.1	67.3						
YALB70M10		M10	3	38.1	21.1	70.4						
YALB70M12		M12	3	38.1	21.1	76.7						
YALB70M14		M14	3	38.1	21.1	77.7						
YALB70M16		M16	3	38.1	21.1	86.4						
YALB95M8	95	M8	3.3	38.1	23.6	68.6	MY2911 (2) MRC840 (4) 644 Series (1) 444 Series (1) 81K Series (2)	W27VT (4) W27RT (4) X27RT (4)	W27VT (4) W27RT (4) X27RT (4)	U27RT (2)	14	40
YALB95M10		M10	3.3	38.1	23.6	71.6						
YALB95M12		M12	3.3	38.1	23.6	78						
YALB95M14		M14	3.3	38.1	23.6	79						
YALB95M16		M16	3.3	38.1	23.6	84.3						
YALB95M20		M20	4.1	38.1	30.5	95.5						

* Use equivalent AWG setting on tool for installation

** PUADP1 Adaptor is required to use U Dies in 46 Series

• P-RT dies for 46 Series Tooling only

TYPE YALB-M (Continued)

NOTE: Field bending straight lugs to achieve an angular connection will void UL Listing / CSA Certifications and BURNDY will not be liable for the connection.

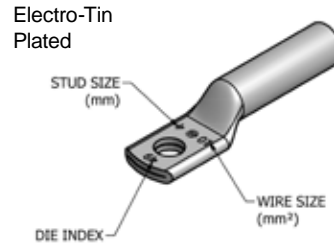
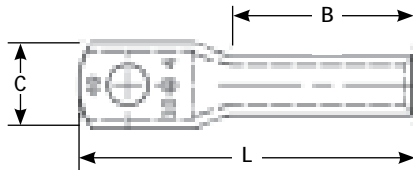

Catalog Number	Wire Range (MM²)	Stud Size	Dimensions (mm)				Installation Tooling					Wire Strip Length
			Tongue Thickness	(B)	(C)	(L)	Dieless	MD6, OUR840, MD734R	500 Series	35, 750, 46** Series	Die Index	
YALB120M8	120	M8	3.6	41.1	29	73.9	MY2911 (2) MRC840 (4) 644 Series (1) 444 Series (1) 81K Series (2)	W28VT (4) W28RT (4) X28RT (6)	W28VT (4) W28RT (4) X28RT (6)	U28RT (2)	15	43
YALB120M10		M10	3.6	41.1	29	77.2						
YALB120M12		M12	3.6	41.1	29	83.6						
YALB120M14		M14	3.6	41.1	29	84.6						
YALB120M16		M16	3.6	41.1	29	89.9						
YALB120M20	M20	4.3	41.1	30.5	101.1							
YALB150M8	150	M8	4.1	50.8	30.5	84.1	644 Series (1) 444 Series (1) 81K Series (3)	W30VT (4)	W30VT (4)	U30RT (4)	17	52
YALB150M10		M10	4.1	50.8	30.5	87.4						
YALB150M12		M12	4.1	50.8	30.5	93.7						
YALB150M14		M14	4.1	50.8	30.5	94.7						
YALB150M16		M16	4.1	50.8	30.5	100.1						
YALB150M20	M20	4.1	50.8	30.5	111.3							
YALB185M8	185	M8	4.3	50.8	32.8	85.1	644 Series (1) 444 Series (1) 81K Series (3)	W31VT (4)	W31VT (4)	U31RT (4)	18	59
YALB185M10		M10	4.3	50.8	32.8	88.4						
YALB185M12		M12	4.3	50.8	32.8	94.7						
YALB185M14		M14	4.3	50.8	32.8	95.3						
YALB185M16		M16	4.3	50.8	32.8	101.1						
YALB185M20	M20	4.3	50.8	32.8	112.3							
YALB240M10	240	M10	5.6	57.2	39.4	98	644 Series (1) 444 Series (1) 81K Series (4)	W34VT (4)	W34VT (4)	U34RT (4)	20	70
YALB240M12		M12	5.6	57.2	39.4	105.2						
YALB240M14		M14	5.6	57.2	39.4	106.2						
YALB240M16		M16	5.6	57.2	39.4	111.3						
YALB240M20		M20	5.6	57.2	39.4	122.4						
YALB300M10	300	M10	6.6	68.3	44.2	111.8	644 Series (1) 444 Series (1) 81K Series (4)	—	—	U36RT (4)	22	76
YALB300M12		M12	6.6	68.3	44.2	118.1						
YALB300M14		M14	6.6	68.3	44.2	119.1						
YALB300M16		M16	6.6	68.3	44.2	124.5						
YALB300M20		M20	6.6	68.3	44.2	135.4						
YALB400M12	400	M12	7.6	74.7	50.3	127	—	—	U39RT (4)	24	78	
YALB400M14		M14	7.6	74.7	50.3	128						
YALB400M16		M16	7.6	74.7	50.3	133.4						
YALB400M20		M20	7.6	74.7	50.3	144.3						
YALB500M12	500	M12	8.1	76.2	55.6	132.1	—	—	U44XRT (4) P44XRT (4)	L115	83	
YALB500M16		M16	8.1	76.2	55.6	138.4						
YALB500M20		M20	8.1	76.2	55.6	149.4						
YALB630M12	630	M12	9.7	81	62.5	139.4	—	—	P45RT (6)	29	83	
YALB630M16		M16	9.7	81	62.5	145.8						
YALB630M20		M20	9.7	81	62.5	157						

* Use equivalent AWG setting on tool for installation

** PUADP1 Adaptor is required to use U Dies in 46 Series

• P-RT dies for 46 Series Tooling only

TYPE YALB-2M

HYLUG™

Rated for 90° C, Up to 35 kV ♦

Made from electrolytic copper tube and is electro-tin plated. Wire range is from 10 mm² to 630 mm² Class 2. Compatible to IEC61238-1.

NOTE: Field bending straight lugs to achieve an angular connection will void UL Listing / CSA Certifications and BURNDY will not be liable for the connection.

Electro-Tin
Plated

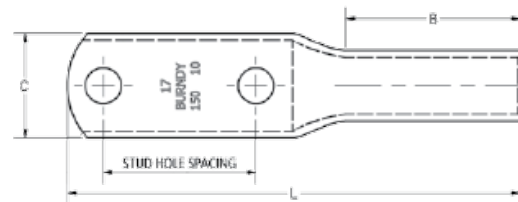
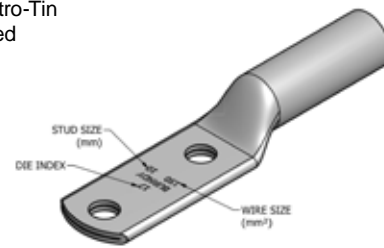

Features & Benefits

- No inspection window is ideal for more corrosive environments as the barrel transition is not open
- Barrel is designed with an internal chamfer at the wire entry to ensure smooth insertion of the wire, preventing possible damaging of the wire strands during installation
- Long barrel allows for an increased number of crimps which will increase the mechanical strength of the connection
- Two hole tongue/tang is recommended when space permits as the 2-hole feature minimizes the terminations from loosening or rotating under vibration, movement, or heat cycling
- Electro-tin plated unless specified to reduce galvanic corrosion (bimetallic) and resist corrosive elements
- Compatible Standards: IEC61238-1, UL 486A-486B, CSA-C22.2 No. 65-03
- Connectors are clearly marked with stamping
- Terminals and splices accommodating code wire: Accommodates Code Class B (Concentric, Compressed, Compact) and Class C wire

Accessories

- Hardware - Section F
- PENETROX™ Oxide Inhibitor - Section F
- Heat and Cold Shrink Tubing - Section D
- WIREMIKE™ Wire Micrometer - Section F
- Wire Management (Cable Ties) - Section G

TYPE YALB-2M (Continued)

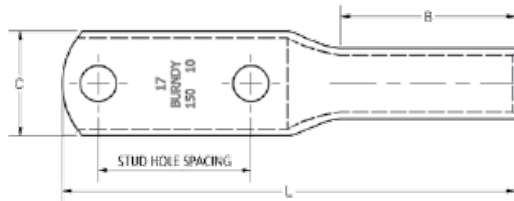

Electro-Tin
Plated

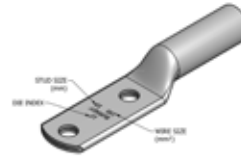

NOTE: Field bending straight lugs to achieve an angular connection will void UL Listing / CSA Certifications and BURNDY will not be liable for the connection.

Catalog Number	Wire Range (MM ²)	Stud Size	Stud Hole Spacing	Dimensions (mm)				Installation Tooling					Wire Strip Length (mm)
				Tongue Thickness	(B)	(C)	(L)	Dieless*	MD6, OUR840, MD734R	500 Series	35, 750, 46** Series	Die Index	
YALB102M4	10	M4	44.5	2.3	20.6	9.9	82.6	Y1MRTC (2) MY2911 (1) MRC840 (2) 81K Series (1)	W8CVT (2) W8CRT (2) X8CRT (2)	W8CVT (2) W8CRT (2) X8CRT (2)	U8CRT (2)	49	22
YALB102M5		M5	44.5	2.0	20.6	10.4	84.3						
YALB102M6		M6	44.5	2.0	20.6	11.2	87.4						
YALB102M8		M8	44.5	1.5	20.6	13.2	88.9						
YALB102M10		M10	44.5	1.5	20.6	14.7	92.2						
YALB102M12		M12	44.5	3.0	20.6	21.1	103.4						
YALB162M4	16	M4	44.5	2.3	28.4	11.4	91.7	Y1MRTC (2) MY2911 (2) MRC840 (2) 81K Series (1)	W5CVT (2) W5CRT (2) X5CRT (2)	W5CVT (2) W5CRT (2) X5CRT (2)	U5CRT (2)	7	30
YALB162M5		M5	44.5	2.3	28.4	11.4	93.2						
YALB162M6		M6	44.5	2.0	28.4	12.2	96.5						
YALB162M8		M8	44.5	1.8	28.4	13.2	98.0						
YALB162M10		M10	44.5	1.5	28.4	14.7	103.6						
YALB162M12		M12	44.5	3.0	28.4	19.1	107.7						
YALB252M5	25	M5	44.5	2.3	31.8	14.0	98.0	W3CRT (2)	W3CRT (2)	U3CRT (2)	9	33	
YALB252M6		M6	44.5	2.3	31.8	14.0	101.1						
YALB252M8		M8	44.5	2.3	31.8	14.0	102.9						
YALB252M10		M10	44.5	2.0	31.8	14.7	105.9						
YALB252M12		M12	44.5	3.0	31.8	21.1	112.5						
YALB352M5	35	M5	44.5	2.5	35.1	17.3	102.1	Y1MRTC (4) MY2911 (2) MRC840 (2) 644 Series (1) 444 Series (1) 81K Series (1)	W2CVT (2) W2CRT (2) X2CRT (2)	W2CVT (2) W2CRT (2) X2CRT (2)	U2CRT (2)	10	37
YALB352M6		M6	44.5	2.5	35.1	17.3	105.2						
YALB352M8		M8	44.5	2.5	35.1	17.3	106.8						
YALB352M10		M10	44.5	2.5	35.1	17.3	110.0						
YALB352M12		M12	44.5	3.0	35.1	21.1	116.4						
YALB502M6	50	M6	44.5	2.5	35.1	17.3	105.2	MY2911 (2) MRC840 (4) 644 Series (1) 444 Series (1) 81K Series (2)	W25VT (4) W25RT (4) X25RT (4)	W25VT (4) W25RT (4) X25RT (4)	U25RT (2)	12	37
YALB502M8		M8	44.5	2.5	35.1	17.3	106.7						
YALB502M10		M10	44.5	2.5	35.1	17.3	110.0						
YALB502M12		M12	44.5	3.0	35.1	21.1	116.3						
YALB502M14		M14	44.5	3.0	35.1	21.1	117.3						
YALB502M16		M16	44.5	3.0	35.1	21.1	122.7						

* Use equivalent AWG setting on tool for installation

** PUADP1 Adaptor is required to use U Dies in 46 Series

• P-RT dies for 46 Series Tooling only

Compression Connections

Copper Compression — Terminal — Code — Two Hole
Long Barrel — Metric Lugs — No Inspection Window

TYPE YALB-2M (Continued)

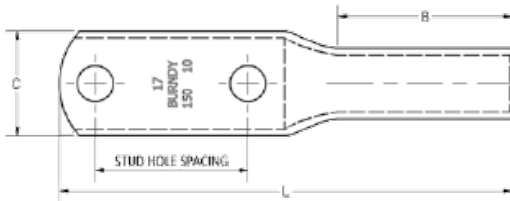

Electro-Tin
Plated

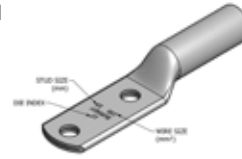

NOTE: Field bending straight lugs to achieve an angular connection will void UL Listing / CSA Certifications and BURNDY will not be liable for the connection.

Catalog Number	Wire Range (MM ²)	Stud Size	Stud Hole Spacing	Dimensions (mm)			Installation Tooling					Wire Strip Length (mm)	
				Tongue Thickness	(B)	(C)	(L)	Dieless*	MD6, OUR840, MD734R	500 Series	35, 750, 46** Series		Die Index
YALB702M6	70	M6	44.5	3.0	38.1	21.1	110.0	MY2911 (2) MRC840 (4) 644 Series (1) 444 Series (1) 81K Series (2)	W26VT (4) W26RT (4) X26RT (4)	W26VT (4) W26RT (4) X26RT (4)	U26RT (2)	13	40
YALB702M8		M8	44.5	3.0	38.1	21.1	111.8						
YALB702M10		M10	44.5	3.0	38.1	21.1	114.8						
YALB702M12		M12	44.5	3.0	38.1	21.1	121.4						
YALB702M14		M14	44.5	3.0	38.1	21.1	122.2						
YALB702M16		M16	44.5	3.0	38.1	21.1	130.8						
YALB952M8	95	M8	44.5	3.3	38.1	23.6	113.0		W27VT (4) W27RT (4) X27RT (6)	W27VT (4) W27RT (4) X27RT (6)	U27RT (2)	14	40
YALB952M10		M10	44.5	3.3	38.1	23.6	116.1						
YALB952M12		M12	44.5	3.3	38.1	23.6	122.4						
YALB952M14		M14	44.5	3.3	38.1	23.6	123.4						
YALB952M16		M16	44.5	3.3	38.1	23.6	128.8						
YALB952M20		M20	44.5	4.1	38.1	30.5	140.0						
YALB1202M8	120	M8	44.5	3.8	41.1	29.0	118.6		W28VT (4) W28RT (4) X28RT (6)	W28VT (4) W28RT (4) X28RT (6)	U28RT (2)	15	43
YALB1202M10		M10	44.5	3.8	41.1	29.0	124.1						
YALB1202M12		M12	44.5	3.8	41.1	29.0	128.0						
YALB1202M14		M14	44.5	3.8	41.1	29.0	129.0						
YALB1202M16		M16	44.5	3.8	41.1	29.0	134.4						
YALB1202M20		M20	44.5	4.3	41.1	30.5	145.5						
YALB1502M8	150	M8	44.5	4.1	50.8	30.5	128.8		W30VT (4)	W30VT (4) W30RT (4)	U30RT (4)	17	52
YALB1502M10		M10	44.5	4.1	50.8	30.5	131.8						
YALB1502M12		M12	44.5	4.1	50.8	30.5	138.2						
YALB1502M14		M14	44.5	4.1	50.8	30.5	139.2						
YALB1502M16		M16	44.5	4.1	50.8	30.5	145.3						
YALB1502M20		M20	44.5	4.1	50.8	30.5	156.2						
YALB1852M8	185	M8	44.5	4.3	50.8	32.8	129.8	W31VT (4)	W31VT (4) W31RT (4)	U31RT (4)	18	52	
YALB1852M10		M10	44.5	4.3	50.8	32.8	132.8						
YALB1852M12		M12	44.5	4.3	50.8	32.8	139.2						
YALB1852M14		M14	44.5	4.3	50.8	32.8	139.7						
YALB1852M16		M16	44.5	4.3	50.8	32.8	145.5						
YALB1852M20		M20	44.5	4.3	50.8	32.8	156.7						

* Use equivalent AWG setting on tool for installation.

** PUADP1 Adaptor is required to use U Dies in 46 Series tools.

† P-RT Die sets for use in 46 Series only, PUADP1 Adaptor not required.

TYPE YALB-2M (Continued)

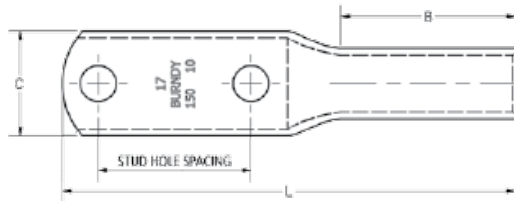

Electro-Tin
Plated

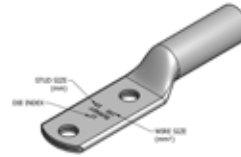

NOTE: Field bending straight lugs to achieve an angular connection will void UL Listing / CSA Certifications and BURNDY will not be liable for the connection.

Catalog Number	Wire Range (MM ²)	Stud Size	Stud Hole Spacing	Dimensions (mm)				Installation Tooling					Wire Strip Length (mm)							
				Tongue Thickness	(B)	(C)	(L)	Dieless*	MD6, OUR840, MD734R	500 Series	35, 750, 46** Series	Die Index								
YALB2402M10	240	M10	44.5	5.6	57.2	39.4	142.5	644 Series (1) 444 Series (1) 81K Series (4)	W34VT (4)	W34VT (4) W34RT (4)	U34RT (4)	20	59							
YALB2402M12		M12	44.5	5.6	57.2	39.4	149.6													
YALB2402M14		M14	44.5	5.6	57.2	39.4	150.6													
YALB2402M16		M16	44.5	5.6	57.2	39.4	156.0													
YALB2402M20		M20	44.5	5.6	57.2	39.4	166.9													
YALB3002M10	300	M10	44.5	6.6	68.3	44.2	156.2		644 Series (1) 444 Series (1) 81K Series (4)	—	—	U36RT (4)	22	70						
YALB3002M12		M12	44.5	6.6	68.3	44.2	162.6													
YALB3002M14		M14	44.5	6.6	68.3	44.2	163.6													
YALB3002M16		M16	44.5	6.6	68.3	44.2	168.9													
YALB3002M20		M20	44.5	6.6	68.3	44.2	179.6													
YALB4002M12	400	M12	44.5	7.6	74.7	50.3	171.4					644 Series (1) 444 Series (1) 81K Series (4)	—	—	U39RT (4)	24	76			
YALB4002M14		M14	44.5	7.6	74.7	50.3	172.5													
YALB4002M16		M16	44.5	7.6	74.7	50.3	177.8													
YALB4002M20		M20	44.5	7.6	74.7	50.3	189.0													
YALB5002M12	500	M12	44.5	8.1	76.2	55.6	176.5								644 Series (1) 444 Series (1) 81K Series (4)	—	—	U44XRT (4) †P44XRT (4)	L115	78
YALB5002M16		M16	44.5	8.1	76.2	55.6	182.9													
YALB5002M20		M20	44.5	8.1	76.2	55.6	194.1													
YALB6302M12	630	M12	44.5	9.7	81.0	62.5	183.9	644 Series (1) 444 Series (1) 81K Series (4)		—	—							† P45RT (6)	29	83
YALB6302M16		M16	44.5	9.7	81.0	62.5	190.5													
YALB6302M20		M20	44.5	9.7	81.0	62.5	201.4													

* Use equivalent AWG setting on tool for installation

** PUADP1 Adaptor is required to use U Dies in 46 Series

• P-RT dies for 46 Series Tooling only

TYPE YAV-FM

HYLUG™

Rated for 90° C, Up to 35 kV ♦

Made from electrolytic copper tube and is electro-tin plated. Wire range is from 50 mm² to 630 mm² Class 5. Compatible to IEC61238-1.

NOTE: Field bending straight lugs to achieve an angular connection will void UL Listing / CSA Certifications and BURNDY will not be liable for the connection.

Features & Benefits

- Inspection window allows for visual verification that the wire has been fully inserted prior to crimping the lug; not recommended in highly corrosive environments as the wire in the barrel is exposed to corrosive elements installed
- Barrel is designed with an internal chamfer at the wire entry to ensure smooth insertion of the wire, preventing possible damaging of the wire strands during installation
- Short/standard length barrel is recommended for installations with limited space requirements
- Electro-tin plated unless specified to reduce galvanic corrosion (bimetallic) and resist corrosive elements
- Compatible Standards: IEC61238-1, UL 486A-486B, CSA-C22.2 No. 65-03
- Connectors are clearly marked with stamping

Accessories

- Hardware - Section F
- PENETROX™ Oxide Inhibitor - Section F
- Heat and Cold Shrink Tubing - Section D
- WIREMIKE™ Wire Micrometer - Section F
- Wire Management (Cable Ties) - Section G

Electro-Tin
Plated

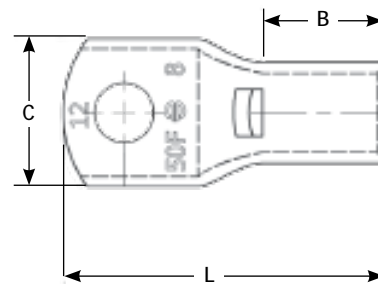
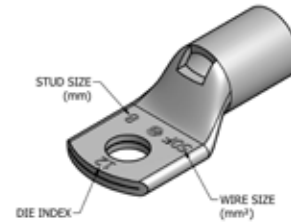

TYPE YAV-FM (Continued)

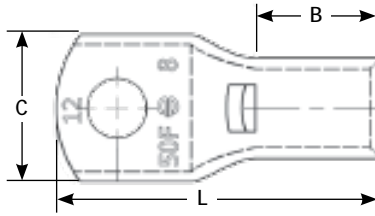

Electro-Tin
Plated

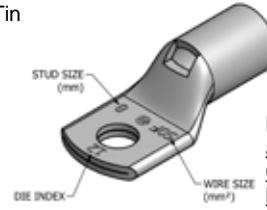

NOTE: Field bending straight lugs to achieve an angular connection will void UL Listing / CSA Certifications and BURNDY will not be liable for the connection.

Catalog Number	Wire Range (MM ²)	Stud Size	Dimensions (mm)				Installation Tooling					Wire Strip Length
			Tongue Thickness	(B)	(C)	(L)	Dieless*	MD6, OUR840, MD734R	500 Series	35, 750, 46** Series	Die Index	
YAV50FM6	50	M6	3.0	17.5	21.1	46.0	MY2911 (1) MRC840 (2) 644 Series (1) 444 Series (1) 81K Series (1)	W25VT (2) W25RT (2) X25RT (2)	W25VT (2) W25RT (2) X25RT (2)	U25RT (1)	12	19
YAV50FM8		M8	3.0	17.5	21.1	46.0						
YAV50FM10		M10	3.0	17.5	21.1	49.3						
YAV50FM12		M12	3.0	17.5	21.1	55.6						
YAV50FM14		M14	3.0	17.5	22.4	56.6						
YAV50FM16		M16	3.0	17.5	22.4	61.9						
YAV70FM6	70	M6	3.3	20.6	23.6	49.0	MY2911 (1) MRC840 (2) 644 Series (1) 444 Series (1) 81K Series (1)	W26VT (2) W26RT (2) X26RT (2)	W26VT (2) W26RT (2) X26RT (2)	U26RT (1)	13	22
YAV70FM8		M8	3.3	20.6	23.6	50.3						
YAV70FM10		M10	3.3	20.6	23.6	54.0						
YAV70FM12		M12	3.3	20.6	23.6	60.0						
YAV70FM14		M14	3.3	20.6	23.6	61.0						
YAV70FM16		M16	3.3	20.6	23.6	66.3						
YAV95FM8	95	M8	3.6	25.4	26.2	56.0	MY2911 (1) MRC840 (2) 644 Series (1) 444 Series (1) 81K Series (2)	W27VT (2) W27RT (2) X27RT (3)	W27VT (2) W27RT (2) X27RT (3)	U27RT (1)	14	27
YAV95FM10		M10	3.6	25.4	26.2	59.0						
YAV95FM12		M12	3.6	25.4	26.2	66.0						
YAV95FM14		M14	3.6	25.4	26.2	66.8						
YAV95FM16		M16	3.6	25.4	26.2	72.1						
YAV95FM20		M20	3.6	25.4	26.2	83.2						
YAV120FM8	120	M8	3.8	26.2	29.0	58.2	MY2911 (1) MRC840 (2) 644 Series (1) 444 Series (1) 81K Series (2)	W28VT (2) W28RT (2) X28RT (3)	W28VT (2) W28RT (2) X28RT (3)	U28RT (1)	15	27
YAV120FM10		M10	3.8	26.2	29.0	61.0						
YAV120FM12		M12	3.8	26.2	29.0	68.0						
YAV120FM14		M14	3.8	26.2	29.0	68.8						
YAV120FM16		M16	3.8	26.2	29.0	74.1						
YAV120FM20		M20	3.8	26.2	29.0	85.2						
YAV150FM8	150	M8	4.6	26.9	32.8	60.2	644 Series (1) 444 Series (1) 81K Series (2)	W30VT (2)	W30VT (2) W30RT (2)	U30RT (2)	17	29
YAV150FM10		M10	4.6	26.9	32.8	64.0						
YAV150FM12		M12	4.6	26.9	32.8	70.0						
YAV150FM14		M14	4.6	26.9	32.8	70.8						
YAV150FM16		M16	4.6	26.9	32.8	76.0						
YAV150FM20		M20	4.6	26.9	32.8	87.3						

* Use equivalent AWG setting on tool for installation

** PUADP1 Adaptor is required to use U Dies in 46 Series

• P-RT dies for 46 Series Tooling only

Compression Connections

Copper Compression — Terminal — Flex — One Hole
Standard Barrel — Metric Lugs — with Inspection Window

TYPE YAV-FM (Continued)

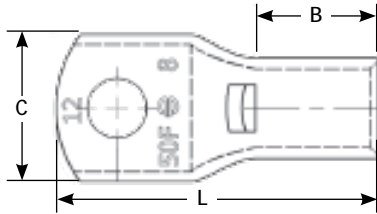

Electro-Tin
Plated

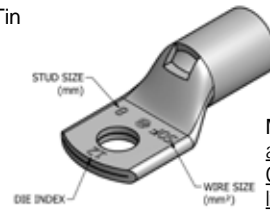

NOTE: Field bending straight lugs to achieve an angular connection will void UL Listing / CSA Certifications and BURNDY will not be liable for the connection.

Catalog Number	Wire Range (MM ²)	Stud Size	Dimensions (mm)				Installation Tooling					Wire Strip Length
			Tongue Thickness	(B)	(C)	(L)	Dieless*	MD6, OUR840, MD734R	500 Series	35, 750, 46** Series	Die Index	
YAV185FM8	185	M8	5.0	30.2	35.6	64.8	644 Series (1) 444 Series (1) 81K Series (2)	W31VT (2)	W31VT (2) W31RT (2)	U31RT (2)	18	29
YAV185FM10		M10	5.0	30.2	35.6	68.0						
YAV185FM12		M12	5.0	30.2	35.6	74.0						
YAV185FM14		M14	5.0	30.2	35.6	75.4						
YAV185FM16		M16	5.0	30.2	35.6	81.0						
YAV185FM20		M20	5.0	30.2	35.6	91.8						
YAV240FM10	240	M10	5.8	32.3	39.4	72.9	644 Series (1) 444 Series (1) 81K Series (2)	W34VT (2)	W34VT (2) W34VT (2)	U34RT (2)	20	33
YAV240FM12		M12	5.8	32.3	39.4	79.0						
YAV240FM14		M14	5.8	32.3	39.4	80.2						
YAV240FM16		M16	5.8	32.3	39.4	85.5						
YAV240FM20		M20	5.8	32.3	39.4	96.6						
YAV300FM10	300	M10	6.9	36.8	46.7	80.2	644 Series (1) 444 Series (1) 81K Series (2)			U36RT (2)	22	38
YAV300FM12		M12	6.9	36.8	46.7	87.0						
YAV300FM14		M14	6.9	36.8	46.7	87.5						
YAV300FM16		M16	6.9	36.8	46.7	93.0						
YAV300FM20		M20	6.9	36.8	46.7	104.0						
YAV400FM12	400	M12	7.6	36.1	50.3	87.0	644 Series (1) 444 Series (1) 81K Series (3)	—	—	U39RT (3)	24	37
YAV400FM14		M14	7.6	36.1	50.3	88.1						
YAV400FM16		M16	7.6	36.1	50.3	93.5						
YAV400FM20		M20	7.6	36.1	50.3	104.5						
YAV500FM12	500	M12	8.4	41.9	55.6	96.0	644 Series (1) 444 Series (1) 81K Series (3)			U44XRT (3) †P44XRT (3)	L115	43
YAV500FM16		M16	8.4	41.9	55.6	102.6						
YAV500FM20		M20	8.4	41.9	55.6	113.7						
YAV630FM12	630	M12	9.9	50.8	68.3	110.2	—			† P46RT (3)	31	55
YAV630FM16		M16	9.9	50.8	68.3	116.6						
YAV630FM20		M20	9.9	50.8	68.3	127.8						

* Use equivalent AWG setting on tool for installation.

** PUADP1 Adaptor is required to use U Dies in 46 Series tools.

† P-RT Die sets for use in 46 Series only, PUADP1 Adaptor not required.

TYPE YAV-F2M

HYLUG™

Rated for 90° C, Up to 35 kV ◆

Made from electrolytic copper tube and is electro-tin plated. Wire range is from 50 mm² to 630 mm² Class 5. Compatible to IEC61238-1.

NOTE: Field bending straight lugs to achieve an angular connection will void UL Listing / CSA Certifications and BURNDY will not be liable for the connection.

Electro-Tin
Plated

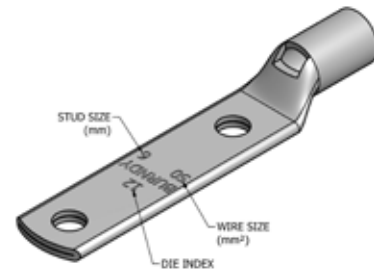

Features & Benefits

- Inspection window allows for visual verification that the wire has been fully inserted prior to crimping the lug
- Barrel is designed with an internal chamfer at the wire entry to ensure smooth insertion of the wire, preventing possible damaging of the wire strands during installation
- Short/standard length barrel is recommended for installations with limited space requirements
- Two hole tongue/tang is recommended when space permits as the 2-hole feature minimizes the terminations from loosening or rotating under vibration, movement, or heat cycling
- Electro-tin plated unless specified to reduce galvanic corrosion (bimetallic) and resist corrosive elements
- Compatible Standards: IEC61238-1, UL 486A-486B, CSA-C22.2 No. 65-03
- Connectors are clearly marked with stamping

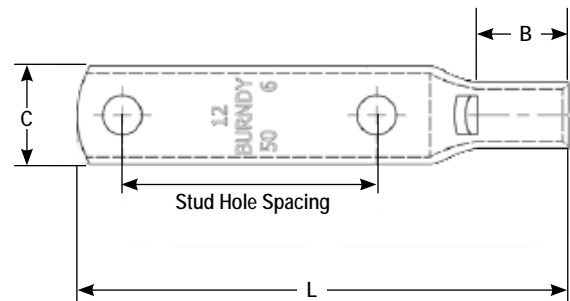

Accessories

- Hardware - Section F
- PENETROX™ Oxide Inhibitor - Section F
- Heat and Cold Shrink Tubing - Section D
- WIREMIKE™ Wire Micrometer - Section F
- Wire Management (Cable Ties) - Section G

Compression Connections

Copper Compression — Terminal — Flex — Two Hole
Long Barrel — Metric Lugs — with Inspection Window

TYPE YAV-F2M (Continued)

NOTE: Field bending straight lugs to achieve an angular connection will void UL Listing / CSA Certifications and BURNDY will not be liable for the connection.

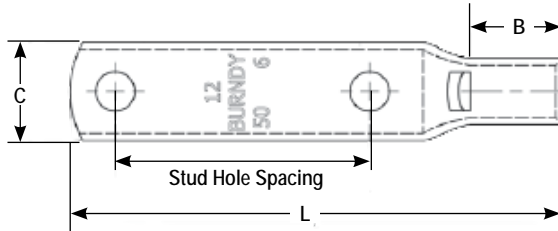

Electro-Tin
Plated

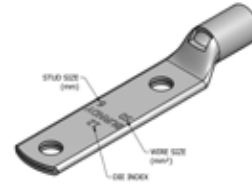

Catalog Number	Wire Range (MM²)	Stud Size	Stud Hole Spacing	Dimensions (mm)				Installation Tooling					Wire Strip Length (mm)
				Tongue Thickness	(B)	(C)	(L)	Dieless*	MD6, OUR840, MD734R	500 Series	35, 750, 46** Series	Die Index	
YAV50F2M6	50	M6	44.5	3.0	17.5	21.1	89.2	MY2911 (1) MRC840 (2) 644 Series (1) 444 Series (1) 81K Series (1)	W25VT (2) W25RT (2) X25RT (2)	W25VT (2) W25RT (2) X25RT (2)	U25RT (1)	12	19
YAV50F2M8		M8	44.5	3.0	17.5	21.1	90.7						
YAV50F2M10		M10	44.5	3.0	17.5	21.1	94.0						
YAV50F2M12		M12	44.5	3.0	17.5	21.1	100.3		W26RT (2) W26VT (2) X26RT (2)	W26RT (2) W26VT (2) X26RT (2)	U26RT (1)	13	22
YAV50F2M14		M14	44.5	3.0	17.5	22.4	101.3						
YAV50F2M16		M16	44.5	3.0	17.5	22.4	106.7						
YAV70F2M6	70	M6	44.5	3.3	20.6	23.6	93.2	MY2911 (1) MRC840 (2) 644 Series (1) 444 Series (1) 81K Series (1)	W27VT (2) W27RT (2) X27RT (3)	W27VT (2) W27RT (2) X27RT (3)	U27RT (1)	14	27
YAV70F2M8		M8	44.5	3.3	20.6	23.6	95.0						
YAV70F2M10		M10	44.5	3.3	20.6	23.6	98.3						
YAV70F2M12		M12	44.5	3.3	20.6	23.6	104.6		W28VT (2) W28RT (2) X28RT (3)	W28VT (2) W28RT (2) X28RT (3)	U28RT (1)	15	27
YAV70F2M14		M14	44.5	3.3	20.6	23.6	105.7						
YAV70F2M16		M16	44.5	3.3	20.6	23.6	111.0						
YAV95F2M8	95	M8	44.5	3.6	25.4	26.2	100.8	MY2911 (1) MRC840 (2) 644 Series (1) 444 Series (1) 81K Series (2)	W30VT (2)	W30VT (2) W30RT (2)	U30RT (2)	17	29
YAV95F2M10		M10	44.5	3.6	25.4	26.2	104.1						
YAV95F2M12		M12	44.5	3.6	25.4	26.2	110.5						
YAV95F2M14		M14	44.5	3.6	25.4	26.2	111.5		W31VT (2) W31RT (2)	W31VT (2) W31RT (2)	U31RT (2)	18	29
YAV95F2M16		M16	44.5	3.6	25.4	26.2	116.8						
YAV95F2M20		M20	44.5	3.6	25.4	26.2	128.0						
YAV120F2M8	120	M8	44.5	3.8	26.2	29.0	102.9	644 Series (1) 444 Series (1) 81K Series (2)	W31VT (2)	W31VT (2) W31RT (2)	U31RT (2)	18	29
YAV120F2M10		M10	44.5	3.8	26.2	29.0	106.2						
YAV120F2M12		M12	44.5	3.8	26.2	29.0	112.5						
YAV120F2M14		M14	44.5	3.8	26.2	29.0	113.5		W31VT (2)	W31VT (2) W31RT (2)	U31RT (2)	18	29
YAV120F2M16		M16	44.5	3.8	26.2	29.0	118.9						
YAV120F2M20		M20	44.5	3.8	26.2	29.0	130.0						
YAV150F2M8	150	M8	44.5	4.6	26.9	32.8	104.9	644 Series (1) 444 Series (1) 81K Series (2)	W30VT (2)	W30VT (2) W30RT (2)	U30RT (2)	17	29
YAV150F2M10		M10	44.5	4.6	26.9	32.8	108.2						
YAV150F2M12		M12	44.5	4.6	26.9	32.8	114.6						
YAV150F2M14		M14	44.5	4.6	26.9	32.8	115.6		W31VT (2)	W31VT (2) W31RT (2)	U31RT (2)	18	29
YAV150F2M16		M16	44.5	4.6	26.9	32.8	120.9						
YAV150F2M20		M20	44.5	4.6	26.9	32.8	132.1						
YAV185F2M8	185	M8	44.5	4.8	30.2	35.6	109.5	644 Series (1) 444 Series (1) 81K Series (2)	W30VT (2)	W30VT (2) W30RT (2)	U30RT (2)	17	29
YAV185F2M10		M10	44.5	4.8	30.2	35.6	112.8						
YAV185F2M12		M12	44.5	4.8	30.2	35.6	119.1						
YAV185F2M14		M14	44.5	4.8	30.2	35.6	120.1		W31VT (2)	W31VT (2) W31RT (2)	U31RT (2)	18	29
YAV185F2M16		M16	44.5	4.8	30.2	35.6	125.5						
YAV185F2M20		M20	44.5	4.8	30.2	35.6	136.7						

* Use equivalent AWG setting on tool for installation

** PUADP1 Adaptor is required to use U Dies in 46 Series

• P-RT dies for 46 Series Tooling only

TYPE YAV-F2M (Continued)

NOTE: Field bending straight lugs to achieve an angular connection will void UL Listing / CSA Certifications and BURNDY will not be liable for the connection.

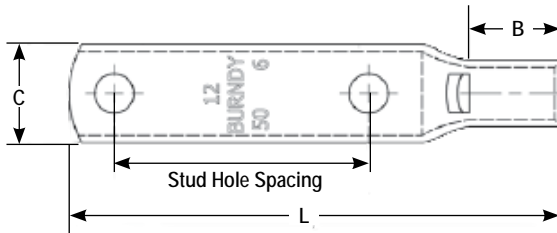

Electro-Tin
Plated



Catalog Number	Wire Range (MM ²)	Stud Size	Stud Hole Spacing	Dimensions (mm)				Installation Tooling					Wire Strip Length (mm)
				Tongue Thickness	(B)	(C)	(L)	Dieless*	MD6, OUR840, MD734R	500 Series	35, 750, 46** Series	Die Index	
YAV240F2M10	240	M10	44.5	5.8	32.3	39.4	117.6	644 Series (1) 444 Series (1) 81K Series (2)	W34VT (2)	W34VT (2) W34RT (2)	U34RT (2)	20	33
YAV240F2M12		M12	44.5	5.8	32.3	39.4	123.9						
YAV240F2M14		M14	44.5	5.8	32.3	39.4	124.9						
YAV240F2M16		M16	44.5	5.8	32.3	39.4	130.3						
YAV240F2M20		M20	44.5	5.8	32.3	39.4	141.3						
YAV300F2M10	300	M10	44.5	6.9	36.8	46.7	124.9	—	—	U36RT (2)	22	38	
YAV300F2M12		M12	44.5	6.9	36.8	46.7	131.3						
YAV300F2M14		M14	44.5	6.9	36.8	46.7	132.2						
YAV300F2M16		M16	44.5	6.9	36.8	46.7	137.7						
YAV300F2M20		M20	44.5	6.9	36.8	46.7	148.7						
YAV400F2M12	400	M12	44.5	7.6	36.1	50.3	131.8	644 Series (1) 444 Series (1) 81K Series (3)	—	—	U39RT (3)	24	37
YAV400F2M14		M14	44.5	7.6	36.1	50.3	138.2						
YAV400F2M16		M16	44.5	7.6	36.1	50.3	149.2						
YAV400F2M20		M20	44.5	7.6	36.1	50.3	149.2						
YAV500F2M12	500	M12	44.5	8.4	41.9	55.6	140.9	—	—	U44XRT (3) †P44XRT (3)	L115	43	
YAV500F2M16		M16	44.5	8.4	41.9	55.6	147.3						
YAV500F2M20		M20	44.5	8.4	41.9	55.6	158.4						
YAV630F2M12	630	M12	44.5	9.9	50.8	68.3	154.9	—	—	† P46RT (3)	31	55	
YAV630F2M16		M16	44.5	9.9	50.8	68.3	161.3						
YAV630F2M20		M20	44.5	9.9	50.8	68.3	172.4						

* Use equivalent AWG setting on tool for installation.

** PUADP1 Adaptor is required to use U Dies in 46 Series tools.

† P-RT Die sets for use in 46 Series only, PUADP1 Adaptor not required.

Compression Connections

Copper Compression — Terminal — Flex — One Hole
Long Barrel — Metric Lugs — No Inspection Window

TYPE YALB-FM

HYLUG™

Rated for 90° C, Up to 35 kV ◆

Made from electrolytic copper tube and is electro-tin plated. Wire range is from 50 mm² to 630 mm² Class 5. Compatible to IEC61238-1.

Features & Benefits

- No inspection window is ideal for more corrosive environments as the barrel transition is not open
- Barrel is designed with an internal chamfer at the wire entry to ensure smooth insertion of the wire, preventing possible damaging of the wire strands during installation
- Long barrel allows for an increased number of crimps which will increase the mechanical strength of the connection
- Electro-tin plated unless specified to reduce galvanic corrosion (bimetallic) and resist corrosive elements
- Compatible Standards: IEC61238-1, UL 486A-486B, CSA-C22.2 No. 65-03
- Connectors are clearly marked with stamping

Accessories

- Hardware - Section F
- PENETROX™ Oxide Inhibitor - Section F
- Heat and Cold Shrink Tubing - Section D
- WIREMIKE™ Wire Micrometer - Section F
- Wire Management (Cable Ties) - Section G

Electro-Tin
Plated

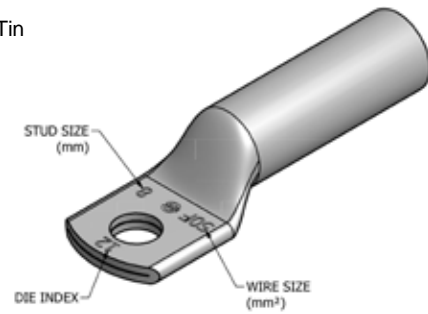

NOTE: Field bending straight lugs to achieve an angular connection will void UL Listing / CSA Certifications and BURNDY will not be liable for the connection.

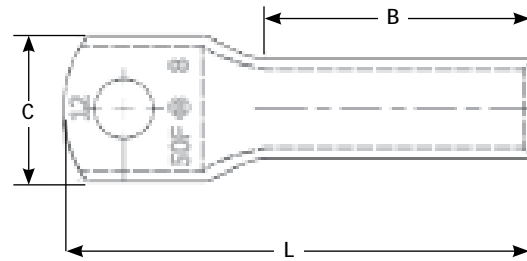

TYPE YALB-FM (Continued)

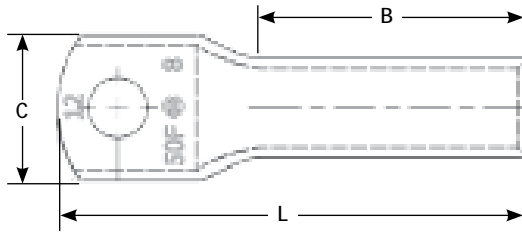

Electro-Tin
Plated

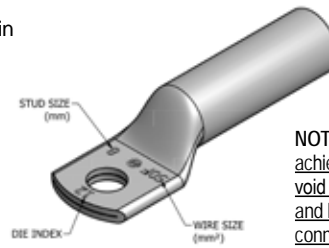

NOTE: Field bending straight lugs to achieve an angular connection will void UL Listing / CSA Certifications and BURNDY will not be liable for the connection.

Catalog Number	Wire Range (MM²)	Stud Size	Dimensions (mm)				Installation Tooling					Wire Strip Length
			Tongue Thickness	(B)	(C)	(L)	Dieless*	MD6, OUR840, MD734R	500 Series	35, 750, 46** Series	Die Index	
YALB50FM6	50	M6	3.0	38.1	21.1	65.5	MY2911 (2) MRC840 (4) 644 Series (1) 444 Series (1) 81K Series (2)	W25VT (4) W25RT (4) X25RT (4)	W25VT (4) W25RT (4) X25RT (4)	U25RT (2)	12	
YALB50FM8		M8	3.0	38.1	21.1	67.3						
YALB50FM10		M10	3.0	38.1	21.1	70.4						
YALB50FM12		M12	3.0	38.1	21.1	76.7						
YALB50FM14		M14	3.0	38.1	21.1	77.7						
YALB50FM16		M16	3.0	38.1	21.1	86.4						
YALB70FM6	70	M6	3.3	38.1	23.6	66.3	MY2911 (2) MRC840 (4) 644 Series (1) 444 Series (1) 81K Series (2)	W26VT (4) W26RT (4) X26RT (4)	W26VT (4) W26RT (4) X26RT (4)	U26RT (2)	13	40
YALB70FM8		M8	3.3	38.1	23.6	68.5						
YALB70FM10		M10	3.3	38.1	23.6	71.7						
YALB70FM12		M12	3.3	38.1	23.6	78.0						
YALB70FM14		M14	3.3	38.1	23.6	79.0						
YALB70FM16		M16	3.3	38.1	23.6	84.3						
YALB95FM8	95	M8	3.6	38.1	26.2	68.8	MY2911 (2) MRC840 (4) 644 Series (1) 444 Series (1) 81K Series (2)	W27VT (4) W27RT (4) X27RT (6)	W27VT (4) W27RT (4) X27RT (6)	U27RT (2)	14	
YALB95FM10		M10	3.6	38.1	26.2	72.1						
YALB95FM12		M12	3.6	38.1	26.2	78.5						
YALB95FM14		M14	3.6	38.1	26.2	79.5						
YALB95FM16		M16	3.6	38.1	26.2	84.8						
YALB95FM20		M20	3.6	38.1	26.2	96.0						
YALB120FM8	120	M8	3.8	41.1	29.0	73.9	MY2911 (2) MRC840 (4) 644 Series (1) 444 Series (1) 81K Series (2)	W28VT (4) W28RT (4) X28RT (6)	W28VT (4) W28RT (4) X28RT (6)	U28RT (2)	15	43
YALB120FM10		M10	3.8	41.1	29.0	79.5						
YALB120FM12		M12	3.8	41.1	29.0	83.6						
YALB120FM14		M14	3.8	41.1	29.0	84.6						
YALB120FM16		M16	3.8	41.1	29.0	89.9						
YALB120FM20		M20	3.8	41.1	29.0	101.1						
YALB150FM8	150	M8	4.3	50.8	32.8	85.1	644 Series (1) 444 Series (1) 81K Series (3)	W30VT (4)	W30VT (4) W30RT (4)	U30RT (4)	17	52
YALB150FM10		M10	4.3	50.8	32.8	88.4						
YALB150FM12		M12	4.3	50.8	32.8	94.7						
YALB150FM14		M14	4.3	50.8	32.8	95.3						
YALB150FM16		M16	4.3	50.8	32.8	101.1						
YALB150FM20		M20	4.3	50.8	32.8	112.3						

* Use equivalent AWG setting on tool for installation.

** PUADP1 Adaptor is required to use U Dies in 46 Series tools.

† P-RT Die sets for use in 46 Series only, PUADP1 Adaptor not required.

Compression Connections

Copper Compression — Terminal — Flex — One Hole
Long Barrel — Metric Lugs — No Inspection Window

TYPE YALB-FM (Continued)

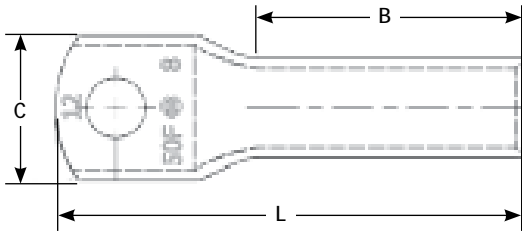

Electro-Tin
Plated

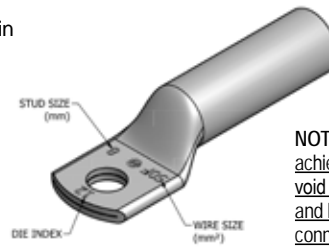

NOTE: Field bending straight lugs to achieve an angular connection will void UL Listing / CSA Certifications and BURNDY will not be liable for the connection.

Catalog Number	Wire Range (MM ²)	Stud Size	Dimensions (mm)				Installation Tooling					
			Tongue Thickness	(B)	(C)	(L)	Dieless*	MD6, OUR840, MD734R	500 Series	35, 750, 46** Series	Die Index	Wire Strip Length
YALB185FM8	185	M8	4.8	53.8	35.6	88.6	644 Series (1) 444 Series (1) 81K Series (3)	W31VT (4)	W31VT (4) W31RT (4)	U31RT (4)	18	52
YALB185FM10		M10	4.8	53.8	35.6	91.7						
YALB185FM12		M12	4.8	53.8	35.6	98.0						
YALB185FM14		M14	4.8	53.8	35.6	99.1						
YALB185FM16		M16	4.8	53.8	35.6	104.4						
YALB185FM20		M20	4.8	53.8	35.6	115.6						
YALB240FM10	240	M10	5.6	57.2	39.4	98.0	644 Series (1) 444 Series (1) 81K Series (4)	W34VT (4)	W34VT (4) W34RT (4)	U34RT (4)	20	59
YALB240FM12		M12	5.6	57.2	39.4	105.2						
YALB240FM14		M14	5.6	57.2	39.4	106.2						
YALB240FM16		M16	5.6	57.2	39.4	111.5						
YALB240FM20		M20	5.6	57.2	39.4	122.4						
YALB300FM10	300	M10	6.9	71.4	46.7	114.8	644 Series (1) 444 Series (1) 81K Series (4)			U36RT (4)	22	73
YALB300FM12		M12	6.9	71.4	46.7	121.2						
YALB300FM14		M14	6.9	71.4	46.7	122.2						
YALB300FM16		M16	6.9	71.4	46.7	127.5						
YALB300FM20		M20	6.9	71.4	46.7	138.7						
YALB400FM12	400	M12	7.6	74.7	50.3	127.0	644 Series (1) 444 Series (1) 81K Series (4)	—	—	U39RT (4)	24	76
YALB400FM14		M14	7.6	74.7	50.3	128.0						
YALB400FM16		M16	7.6	74.7	50.3	133.4						
YALB400FM20		M20	7.6	74.7	50.3	144.5						
YALB500FM12	500	M12	8.1	76.2	55.6	132.1	644 Series (1) 444 Series (1) 81K Series (4)			U44XRT (4) †P44XRT (4)	L115	78
YALB500FM16		M16	8.1	76.2	55.6	138.4						
YALB500FM20		M20	8.1	76.2	55.6	149.4						
YALB630FM12	630	M12	9.9	81.0	68.3	140.5	—			† P46RT (6)	31	83
YALB630FM16		M16	9.9	81.0	68.3	146.8						
YALB630FM20		M20	9.9	81.0	68.3	158.0						

* Use equivalent AWG setting on tool for installation

** PUADP1 Adaptor is required to use U Dies in 46 Series

• P-RT dies for 46 Series Tooling only

TYPE YALB-F2M

HYLUG™

Rated for 90° C, Up to 35 kV ◆

Made from electrolytic copper tube and is electro-tin plated. Wire range is from 50 mm² to 630 mm² Class 5. Compatible to IEC61238-1.

Features & Benefits

- No inspection window is ideal for more corrosive environments as the barrel transition is not open
- Barrel is designed with an internal chamfer at the wire entry to ensure smooth insertion of the wire, preventing possible damaging of the wire strands during installation
- Long barrel allows for an increased number of crimps which will increase the mechanical strength of the connection
- Two hole tongue/tang is recommended when space permits as the 2-hole feature minimizes the terminations from loosening or rotating under vibration, movement, or heat cycling
- Electro-tin plated unless specified to reduce galvanic corrosion (bimetallic) and resist corrosive elements
- Compatible Standards: IEC61238-1, UL 486A-486B, CSA-C22.2 No. 65-03
- Connectors are clearly marked with stamping

Accessories

- Hardware - Section F
- PENETROX™ Oxide Inhibitor - Section F
- Heat and Cold Shrink Tubing - Section D
- WIREMIKE™ Wire Micrometer - Section F
- Wire Management (Cable Ties) - Section G

Electro-Tin
Plated

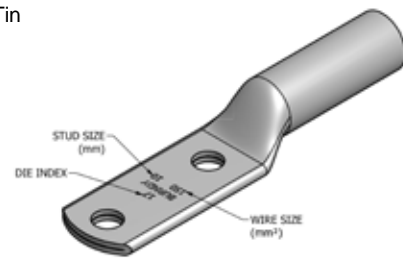

NOTE: Field bending straight lugs to achieve an angular connection will void UL Listing / CSA Certifications and BURNDY will not be liable for the connection.

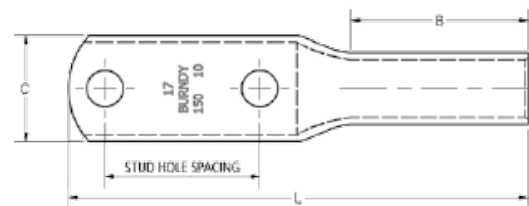

Compression Connections

Copper Compression — Terminal — Flex — Two Hole
Long Barrel — Metric Lugs — No Inspection Window

TYPE YALB-F2M (Continued)

NOTE: Field bending straight lugs to achieve an angular connection will void UL Listing / CSA Certifications and BURNDY will not be liable for the connection.

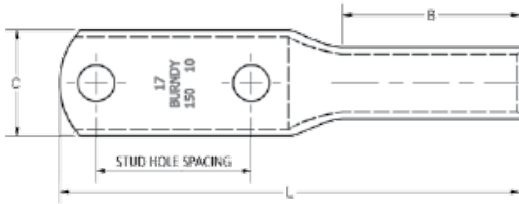

Electro-Tin
Plated

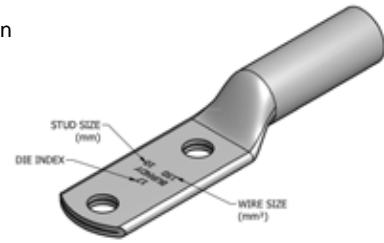

Catalog Number	Wire Range (MM²)	Stud Size	Stud Hole Spacing	Dimensions (mm)				Installation Tooling					Wire Strip Length (mm)
				Tongue Width	(B)	(C)	(L)	Dieless*	MD6, OUR840, MD734R	500 Series	35, 750, 46** Series	Die Index	
YALB50F2M6	50	M6	44.5	3.0	38.1	21.1	110.2	MY2911 (2) MRC840 (4) 644 Series (1) 444 Series (1) 81K Series (2)	W25VT (4) W25RT (4) X25RT (4)	W25VT (4) W25RT (4) X25RT (4)	U25RT (2)	12	
YALB50F2M8		M8	44.5	3.0	38.1	21.1	112.0						
YALB50F2M10		M10	44.5	3.0	38.1	21.1	115.1						
YALB50F2M12		M12	44.5	3.0	38.1	21.1	121.4						
YALB50F2M14		M14	44.5	3.0	38.1	21.1	122.4						
YALB50F2M16		M16	44.5	3.0	38.1	21.1	131.1						
YALB70F2M6	70	M6	44.5	3.3	38.1	23.6	111.0	MY2911 (2) MRC840 (4) 644 Series (1) 444 Series (1) 81K Series (2)	W26VT (4) W26RT (4) X26RT (4)	W26VT (4) W26RT (4) X26RT (4)	U26RT (2)	13	40
YALB70F2M8		M8	44.5	3.3	38.1	23.6	113.3						
YALB70F2M10		M10	44.5	3.3	38.1	23.6	116.3						
YALB70F2M12		M12	44.5	3.3	38.1	23.6	122.7						
YALB70F2M14		M14	44.5	3.3	38.1	23.6	123.7						
YALB70F2M16		M16	44.5	3.3	38.1	23.6	129.0						
YALB95F2M8	95	M8	44.5	3.6	38.1	26.2	114.3	MY2911 (2) MRC840 (4) 644 Series (1) 444 Series (1) 81K Series (2)	W27VT (4) W27RT (4) X27RT (6)	W27VT (4) W27RT (4) X27RT (6)	U27RT (2)	14	
YALB95F2M10		M10	44.5	3.6	38.1	26.2	117.6						
YALB95F2M12		M12	44.5	3.6	38.1	26.2	124.0						
YALB95F2M14		M14	44.5	3.6	38.1	26.2	125.0						
YALB95F2M16		M16	44.5	3.6	38.1	26.2	130.3						
YALB95F2M20		M20	44.5	3.6	38.1	26.2	141.2						
YALB120F2M8	120	M8	44.5	3.8	41.1	29.0	118.6	MY2911 (2) MRC840 (4) 644 Series (1) 444 Series (1) 81K Series (2)	W28VT (4) W28RT (4) X28RT (6)	W28VT (4) W28RT (4) X28RT (6)	U28RT (2)	15	43
YALB120F2M10		M10	44.5	3.8	41.1	29.0	124.2						
YALB120F2M12		M12	44.5	3.8	41.1	29.0	128.3						
YALB120F2M14		M14	44.5	3.8	41.1	29.0	129.3						
YALB120F2M16		M16	44.5	3.8	41.1	29.0	134.6						
YALB120F2M20		M20	44.5	4.3	41.1	30.5	145.8						
YALB150F2M8	150	M8	44.5	4.3	50.8	32.8	129.8	644 Series (1) 444 Series (1) 81K Series (3)	W30VT (4)	W30VT (4) W30RT (4)	U30RT (4)	17	52
YALB150F2M10		M10	44.5	4.3	50.8	32.8	133.1						
YALB150F2M12		M12	44.5	4.3	50.8	32.8	139.4						
YALB150F2M14		M14	44.5	4.3	50.8	32.8	140.0						
YALB150F2M16		M16	44.5	4.3	50.8	32.8	145.8						
YALB150F2M20		M20	44.5	4.3	50.8	32.8	157.0						

* Use equivalent AWG setting on tool for installation.

** PUADP1 Adaptor is required to use U Dies in 46 Series tools.

† P-RT Die sets for use in 46 Series only, PUADP1 Adaptor not required.

TYPE YALB-F2M (Continued)

NOTE: Field bending straight lugs to achieve an angular connection will void UL Listing / CSA Certifications and BURNDY will not be liable for the connection.

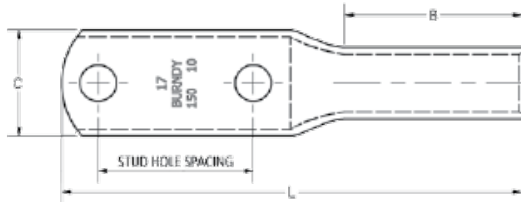

Electro-Tin
Plated

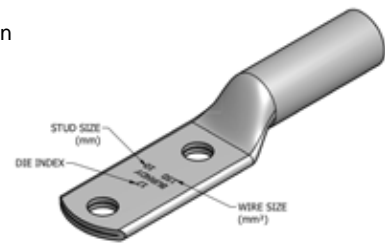

Catalog Number	Wire Range (MM²)	Stud Size	Stud Hole Spacing	Dimensions (mm)				Installation Tooling					Wire Strip Length (mm)
				Tongue Thickness	(B)	(C)	(L)	Dieless*	MD6, OUR840, MD734R	500 Series	35, 750, 46** Series	Die Index	
YALB185F2M8	185	M8	44.5	4.8	53.8	35.6	134.1	644 Series (1) 444 Series (1) 81K Series (3)	W31VT (4)	W31VT (4) W31RT (4)	U31RT (4)	18	52
YALB185F2M10		M10	44.5	4.8	53.8	35.6	137.4						
YALB185F2M12		M12	44.5	4.8	53.8	35.6	143.8						
YALB185F2M14		M14	44.5	4.8	53.8	35.6	144.8						
YALB185F2M16		M16	44.5	4.8	53.8	35.6	150.1						
YALB185F2M20		M20	44.5	4.8	53.8	35.6	161.3						
YALB240F2M10	240	M10	44.5	5.6	57.2	39.4	142.7	644 Series (1) 444 Series (1) 81K Series (4)	W34VT (4)	W34VT (4) W34RT (4)	U34RT (4)	20	59
YALB240F2M12		M12	44.5	5.6	57.2	39.4	149.9						
YALB240F2M14		M14	44.5	5.6	57.2	39.4	150.9						
YALB240F2M16		M16	44.5	5.6	57.2	39.4	156.2						
YALB240F2M20		M20	44.5	5.6	57.2	39.4	167.1						
YALB300F2M10	300	M10	44.5	6.9	71.4	46.7	160.8	644 Series (1) 444 Series (1) 81K Series (4)	—	—	U36RT (4)	22	73
YALB300F2M12		M12	44.5	6.9	71.4	46.7	167.1						
YALB300F2M14		M14	44.5	6.9	71.4	46.7	168.1						
YALB300F2M16		M16	44.5	6.9	71.4	46.7	173.5						
YALB300F2M20		M20	44.5	6.9	71.4	46.7	184.7						
YALB400F2M12	400	M12	44.5	7.6	74.7	50.3	171.7	—	—	U39RT (4)	24	76	
YALB400F2M14		M14	44.5	7.6	74.7	50.3	172.7						
YALB400F2M16		M16	44.5	7.6	74.7	50.3	178.1						
YALB400F2M20		M20	44.5	7.6	74.7	50.3	189.2						
YALB500F2M12	500	M12	44.5	8.1	76.2	55.6	176.8	—	—	U44XRT (4) †P44XRT (4)	L115	78	
YALB500F2M16		M16	44.5	8.1	76.2	55.6	183.1						
YALB500F2M20		M20	44.5	8.1	76.2	55.6	194.1						
YALB630F2M12	630	M12	44.5	9.9	81.0	68.3	186.9	—	—	† P46RT (6)	31	83	
YALB630F2M16		M16	44.5	9.9	81.0	68.3	193.3						
YALB630F2M20		M20	44.5	9.9	81.0	68.3	204.5						

* Use equivalent AWG setting on tool for installation

** PUADP1 Adaptor is required to use U Dies in 46 Series

• P-RT dies for 46 Series Tooling only

TYPE CUSA

HYSTACK™ Terminal Stacking Adapter

The HYSTACK™ adapter is specially designed to get terminals to the back end of a bus bar or other areas that require terminals to be elevated off the mounting surface. These HYSTACK™ adapters are made from high conductivity copper and tin-plated to provide optimum corrosion resistance. It will accommodate #10 AWG through 750 kcmil HYLUG™ terminals.

Features & Benefits

- For use on terminals made from copper
- Designed specifically for stacking standard terminals; uses include:
 - Place the stacking adapter on the mounting plate and a terminal on top of the stacking adapter and bolt down
 - Placing a stacking adapter on a terminal pad that will be mounted to a bus bar or mounting plate and a terminal on top of the stacking adapter, and bolt down
- May be used with standard NEMA two and four hole terminals; to stack four hole NEMA terminations use two stacking adapters assembled side-by-side
- Stacking adapters are clearly marked

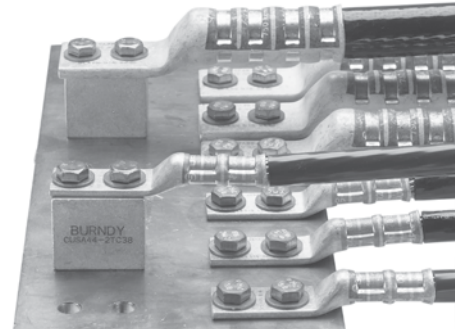

Catalog Number	Stud Hole Size	Stud Hole Spacing	Length (L)	Width (W)	Height (H)
CUSA442TC38	3/8"	1"	1.75"	1.12"	1.50"
CUSA442NTC	1/2"	1-3/4"	3.00"	1.12"	1.50"

Note: All dimensions shown are for reference only.

Reference: Catalog Number TMH332.

This TMH332 Kit has just the right hardware when using the CUSA442TC38 HYSTACK on a 1/4 bus bar with a 4/0 through 750 kcmil HYLUG™.

TYPE ASA-U

HYSTACK™ Terminal Stacking Adapter

UL Listed 90° C, Up to 35 kV ♦

The HYSTACK™ adapter is specially designed to allow standard terminals to be stacked on two or four hole NEMA transformer or equipment terminal pads. HYSTACK™ adapters are tin-plated, high conductivity aluminum to provide optimum corrosion resistance. Only three sizes accommodate terminals from 250 kcmil through 1000 kcmil to help keep costly inventories to a minimum.

Features & Benefits

- For use on terminals made from copper or aluminum material
- Designed specifically for stacking standard terminals; uses include:
 - Place the stacking adapter on the mounting plate and a terminal on top of the stacking adapter and bolt down
 - Placing a stacking adapter on a terminal pad that will be mounted to a bus bar or mounting plate and a terminal on top of the stacking adapter, and bolt down
- May be used with standard NEMA two and four hole terminals; to stack four hole NEMA terminations use two stacking adapters assembled side-by-side
- Only three sizes necessary to accommodate terminals from 250 kcmil through 1000 kcmil, minimizing inventory requirements
- Stacking adapters are clearly marked

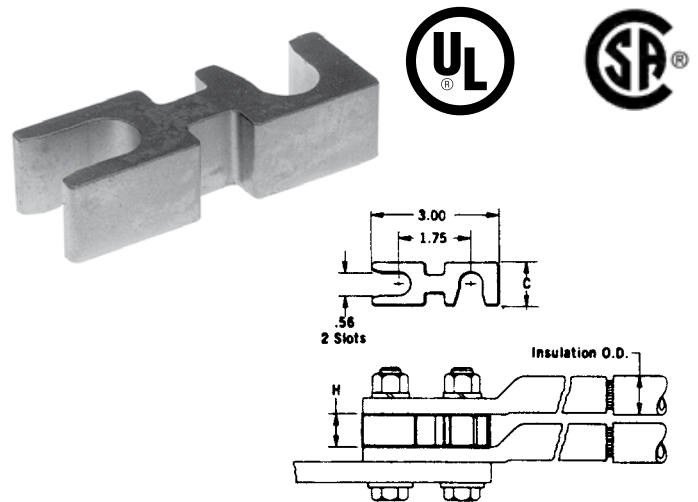

Accommodates Copper and Aluminum Compression Terminals		Catalog Number	Width (W)	Height (H)
Conductor Max.	Insulation O.D.			
250 kcmil	0.87	ASA250U	1.00	0.77
800 kcmil	1.37	ASA800U	1.00	1.13
1000 kcmil	1.49	ASA1000U	1.25	1.25

To stack 4 hole NEMA drilled terminals use 2 adaptors assembled side by side. ASA-U stacking adaptors are recommended for use with any BURNDY® UL Listed compression terminal, 2 or 4 hole NEMA pad aluminum and copper lugs, types YA, YA-L, YA-A, and for all 2-hole NEMA spaced lugs in the OVERHEAD and UNDERGROUND catalog sections.

Note: All dimensions shown are for reference only.

TYPE YSCM

Color-Coded HYLINK™ Uninsulated Parallel Splice

Type YSCM HYLINK™ seamless parallel splice connectors permit stranded wires to be laid parallel inside the connector and spliced together with BURNDY® compression tools. Each YSCM style splice accommodates a wide range of conductors and is color-coded to ensure proper tool and die match. Type YSCM connectors are cULus 486A-486B Listed Wire Connectors and UL 467A/B for Grounding and Bonding, and UL 467 rated for Direct Burial in earth and concrete.



Features & Benefits

- Copper seamless barrel uninsulated parallel splice
- Designed to accommodate a wide range of stranded wires to be laid parallel inside the barrel and spliced together
- Barrel is designed with an internal chamfer at the wire entry to ensure smooth insertion of the wire, preventing possible damaging of the wire strands during insertion
- Electro-tin plated unless otherwise specified to reduce galvanic corrosion (bimetallic) and resist corrosive elements
- Barrel is color coded to ensure proper die and installation tooling is selected
- Type YSCM Uninsulated Parallel Splices are cULus Listed Wire Connectors per UL 467A-467B for Grounding and Bonding
- UL 467 Rated for Direct Burial in earth and concrete
- UL 486A-486B Listed and CSA Certified
- BURNDY certifies its products using the BURNDY Engineered System and select other crimp tool manufacturers in accordance with one or more of the UL categories in order to obtain a UL Listing
- Terminals and splices accommodating code wire: Accommodates Code Class B (Concentric, Compressed, Compact) and Class C wire

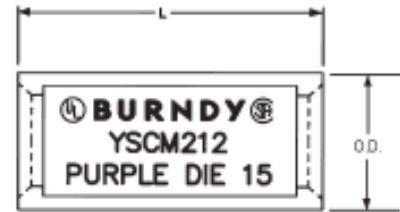

Accessories

- Hardware - Section F
- PENETROX™ Oxide Inhibitor - Section F
- Heat and Cold Shrink Tubing - Section D
- WIREMIKE™ Wire Micrometer - Section F
- Wire Management (Cable Ties) - Section G

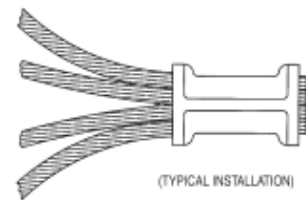

Compression Connections

Copper Compression
Color-Coded Parallel Splice

TYPE YSCM (Continued)



Catalog Number	Conductor Range Cable Circular Mils	Dimensions Inches [mm]		Color Code	Die Index	Recommended Installation Tooling		Wire Strip Length
		L ±.03	O.D. ±.01			OUR840, 500, 600 Series	35, 750 Series	
YSCM17	13,060 - 16,910	0.50 [13]	0.27 [7]	Red	49	X8CRT, W8CRT	U8CRT	11/16
YSCM27	16,910 - 26,890	0.50 [13]	0.31 [8]	Blue	7	X5CRT, W5CRT	U5CRT	11/16
YSCM42	29,970 - 41,520	0.50 [13]	0.38 [10]	Gray	8	X4CRT, W4CRT	U4CRT	11/16
YSCM66	42,750 - 66,040	0.62 [16]	0.47 [12]	Brown	10	X2CRT, W2CRT	U2CRT	3/4
YSCM80	67,980 - 80,020	0.62 [16]	0.52 [13]	Green	11	X1CRT, W1CRT-1	U1CRT-1	3/4
YSCM104	82,870 - 103,630	0.69 [18]	0.57 [14]	Pink	12	X25RT, W25RT	U25RT	15/16
YSCM133	104,960 - 133,220	0.81 [21]	0.64 [16]	Black	13	X26RT, W26RT	U26RT	1-1/16
YSCM167	134,340 - 166,560	0.81 [21]	0.70 [18]	Orange	14	X27RT, W27RT	U27RT	1-1/16
YSCM212	167,380 - 211,820	0.88 [22]	0.78 [20]	Purple	15	X28RT, W28RT	U28RT	1-1/16
YSCM231	- 230,800	1.05 [27]	0.81 [21]	Yellow	16	X29RT, W29RT	U29RT	1-1/16

Notes:

1. Material: Copper per ASTM B75.
 2. Finish: Tin plated. For nickel plating, add suffix "NK" to the Catalog Number.
- † Recommended strip length. Strip length dependant on size, no. of wires and insulation thickness.
- ‡ Refer to Circular Mil Table per ASTM B8 for total Class B Circular Mil calculations.
- * YSCM231 can also be installed with MY293 and retain Listings.

Add the circular mils of the wires you wish to splice; that sum would be used to determine the correct splice using the Min/Max on the table above.

The table to the right is for reference only.

Circular Mil Table per ASTM B8			
Size		ASTM Strandings	
Circular Mils	AWG	Class	Cable Diameter (in)
1,022	20	B	0.036
1,624	18	B	0.045
2,583	16	B	0.057
4,107	14	B	0.072
6,530	12	B	0.091
10,380	10	B	0.116
13,090	9	B	0.130
16,510	8	B	0.146
20,820	7	B	0.164
26,250	6	B	0.184
33,100	5	B	0.206
41,740	4	AA	0.254
41,740	4	B&A	0.232
52,630	3	AA	0.285
52,630	3	B&A	0.260
66,370	2	AA	0.320
66,370	2	B&A	0.292
83,690	1	AA	0.360
83,690	1	A	0.328
83,690	1	B	0.332
105,500	1/0	A&A	0.368
105,500	1/0	—	0.390
105,500	1/0	B	0.373
133,100	2/0	A&A	0.414
133,100	2/0	—	0.438
133,100	2/0	B	0.419
167,800	3/0	A&A	0.464
167,800	3/0	—	0.492
167,800	3/0	B	0.470
211,600	4/0	A&A	0.522
211,600	4/0	—	0.522
211,600	4/0	B	0.528

TYPE YS-L

HYLINK™ Splice

UL Listed 90° C, Up to 35 kV ♦

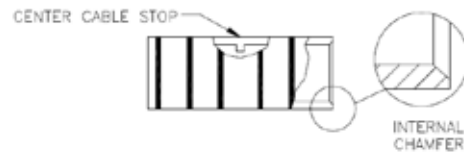
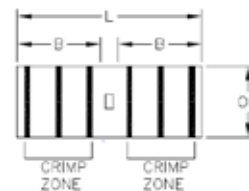
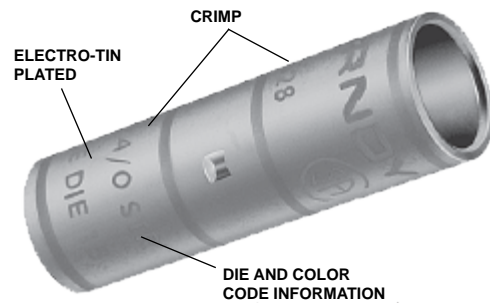

Features & Benefits

- Copper seamless barrel has center stop indentations used to indicate when wire is fully inserted into each side of the barrel
- Barrel is designed with an internal chamfer at the wire entry to ensure smooth insertion of the wire, preventing possible damaging of the wire strands during insertion
- Electro-tin plated unless otherwise specified to reduce galvanic corrosion (bimetallic) and resist corrosive elements
- Short/standard length barrel is recommended for installation with limited space requirements
- Connectors clearly marked with color coding
- BURNDY certifies its products using the BURNDY Engineered System and select other crimp tool manufacturers in accordance with one or more of the UL categories in order to obtain a UL Listing
- Terminals and splices accommodating code wire: Accommodates Code Class B (Concentric, Compressed, Compact) and Class C wire

Catalog Number	Conductor		Dimensions			Dieless (# of crimps)	Installation Tooling ▲						Wire Strip Length	
	Code (B, C)	*** MM ²	Outside Diameter (O.D.)	L	B		Mechanical			35 ■, 750, 46* Series		▲ Die Index		
							Y1MRTC Y2MR	MD734R	MD6 OUR840	Die Number (# crimps)	Color Code			
YS8CLBOX	8 AWG	10	0.27	1.00	0.44	81K Series (1)	Y1MRTC (1)	W8CVT (1)	X8CRT (1)	U8CRT (1)	Red	49	1/2"	
YS6CLBOX	6 AWG	—	0.29	1.75	0.81			W5CVT (1)	X5CRT (1)	U5CRT (1)	Blue	7	7/8"	
YS5CLBOX	5 AWG	16	0.30	1.90	0.81			W4CVT (1)	X4CRT (1)	U4CRT (1)	Gray	8	7/8"	
YS4CLBOX	4 AWG	—	0.34	1.75	0.81		Y1MRTC (2)	—	—	U3CRT (1)	White	9	15/16"	
YS3CL	3 AWG 2 Sol	25	0.38	2.05	0.88			W2CVT (1)	X2CRT (1)	U2CRT (1)	Brown	10	15/16"	
YS2CLBOX	2 AWG	—	0.42	2.00	0.88			W1CVT (1)	X1CRT (1)	U1CRT1 (1)	Green	11	15/16"	
YS1CLBOX	1 AWG	50	0.46	2.06	0.88			W25VT (2)	X25RT (2)	U25RT (1)	Pink	12	15/16"	
YS25LBOX	1/0 AWG	—	0.51	2.08	0.88		81K Series (2)	—	W26VT (2)	X26RT (2)	U26RT (1)	Black	13	1"
YS26LBOX	2/0 AWG	70	0.56	2.17	0.94				W27VT (2)	X27RT (2)	U27RT (1)	Orange	14	1-1/16"
YS27LBOX	3/0 AWG	95	0.62	2.30	1.00				W28VT (2)	X28RT (2)	U28RT (1)	Purple	15	1-1/16"
YS28LBOX	4/0 AWG	—	0.69	2.32	1.00	W29VT (2)			—	U29RT (1)	Yellow	16	1-1/8"	
YS29LBOX	250 kcmil	120	0.75	2.46	1.06	W30VT (2)			—	U30RT (2)	White	17	1-1/8"	
YS30L	300 kcmil	150	0.81	2.47	1.06	W31VT (2)			—	U31RT (2)	Red	18	1-3/16"	
YS31L	350 kcmil	185	0.88	2.60	1.12	W32VT (2)			—	U32RT (2)	Blue	19	1-1/4"	
YS32L	400 kcmil	—	0.95	2.74	1.19	W33VT (2)			—	U33RT (2)	Green	20	1-7/16"	
YS34L	500 kcmil	240	1.06	3.15	1.38	W34VT (2)			—	U34RT (2)	Brown	22	1-7/16"	
YS36L	600 kcmil	300	1.18	3.22	1.38	81K Series (3)			—	—	—	U36RT (2)	Green	400
YS38L	700 kcmil	—	1.25	3.22	1.38		—	—		U38RT (2)	Pink	24	1-11/16"	
YS39L	750 kcmil	—	1.30	3.72	1.62		—	—		U39RT (2)	Black	27	1-15/16"	
YS44L	1000 kcmil	500	1.49	4.28	1.88		—	—		P44RT (3)**	White	27	1-15/16"	

▲ See tooling section of this catalog for complete tool and die listings.

* Use PUADP1 adapter with U dies in 46 Series.

** P44RT for use with 46 Series only. PUADP1 adaptor not required.

*** The MM² conductor sizes listed are the recommendations for Class 2 conductor.

■ The maximum size for the Y35 is 400 kcmil insulated code cable.

♦ For applications greater than 2000 Volts consult cable manufacturer for voltage stress relief instructions.

Note: All dimensions shown are for reference only.

Compression Connections

Copper — Code Long Barrel Splice

TYPE YS

HYLINK™ Splice, Long Barrel

UL Listed 90° C, Up to 35 kV ♦



Features & Benefits

- Copper seamless barrel has center stop indentations used to indicate when wire is fully inserted into each side of the barrel
- Barrel is designed with an internal chamfer at the wire entry to ensure smooth insertion of the wire,
- Electro-tin plated unless otherwise specified to reduce galvanic corrosion (bimetallic) and resist corrosive elements
- Barrel is color coded to ensure proper die and installation tooling is selected
- Long barrel allows for an increased number of crimps which will increase the mechanical strength of the connection
- Terminals and splices accommodating code wire: Accommodates Code Class B (Concentric, Compressed, Compact) and Class C wire

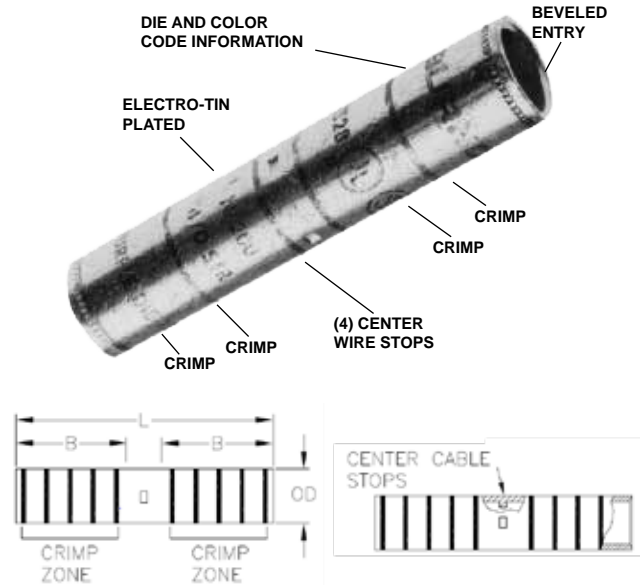

Catalog Number	Conductor			Dimensions		Installation Tooling ▲					Wire Strip Length		
	Code (B, C)	mm ²	Outside Diameter (O.D.)	L	B	Dieless (# of crimps)	Mechanical			35 ■, 750, 46* Series			
							Y1MRTC	MD734R	MD6 OUR840	Die Number (# crimps)		Color Code	▲ Die Index
YS8C	8 AWG	10	0.27	1.75	0.78	81K Series (1)	Y1MRTC (2)	W8CVT (2)	X8CRT (2)	U8CRT (2)	Red	49	7/8
YS6C	6 AWG	—	0.29	2.38	1.09		Y1MRTC (2)	W5CVT (2)	X5CRT (2)	U5CRT (2)	Blue	7	1-3/16
YS5C	5 AWG	16	0.30	2.55	1.09		Y1MRTC (2)	W5CVT (2)	X5CRT (2)	U5CRT (2)	Blue	7	1-3/16
YS4C	4 AWG	—	0.34	2.55	1.09		Y1MRTC (2)	W4CVT (2)	X4CRT (2)	U4CRT (2)	Gray	8	1-3/16
YS3C	3 AWG / 2 Sol	25	0.38	2.80	1.22	81K Series (2)	Y1MRTC (4)	—	W3CRT (2)	—	White	9	1-5/16
YS2C	2 AWG	35	0.42	2.82	1.22		Y1MRTC (4)	W2CVT (2)	X2CRT (2)	U2CRT (2)	Brown	10	1-5/16
YS1C	1 AWG	50	0.46	3.07	1.34		Y1MRTC (4)	W1CVT (2)	X1CRT1 (2)	U1CRT1 (2)	Green	11	1-7/16
YS25	1/0 AWG	—	0.51	3.08	1.34		—	W25VT (4)	X25RT (4)	U25RT (2)	Pink	12	1-7/16
YS26	2/0 AWG	70	0.56	3.30	1.45		—	W26VT (4)	X26RT (4)	U26RT (2)	Black	13	1-9/16
YS27	3/0 AWG	—	0.62	3.30	1.45		—	W27VT (4)	X27RT (4)	U27RT (2)	Orange	14	1-9/16
YS28	4/0 AWG	—	0.69	3.57	1.58		—	W28VT (4)	X28RT (4)	U28RT (2)	Purple	15	1-11/16
YS29	250 kcmil	120	0.75	3.58	1.58		—	W29VT (4)	—	U29RT (2)	Yellow	16	1-11/16
YS30	300 kcmil	150	0.81	4.34	1.95	81K Series (3)	—	W30VT (4)	—	U30RT (4)	White	17	2-1/16
YS31	350 kcmil	185	0.88	4.35	1.95		—	W31VT (4)	—	U31RT (4)	Red	18	2-1/16
YS32	400 kcmil	—	0.95	4.62	2.08		—	W32VT (4)	—	U32RT (4)	Blue	19	2-3/16
YS34	500 kcmil	240	1.06	4.91	2.20	81K Series (4)	—	W34VT (4)	—	U34RT (4)	Brown	20	2-5/16
YS36	600 kcmil	300	1.18	5.85	2.63		—	—	—	U36RT (4)	Green	22	2-3/4
YS39	750 kcmil	—	1.30	6.38	2.81		—	—	—	U39RT (4)	Black	24	2-15/16
YS44	1000 kcmil	500	1.49	6.55	2.94		—	—	—	P44RT (6)	White	27	3-1/16
YS46	1500 kcmil	—	1.84	7.01	3.13		—	—	—	P46RT (6)	Green	31	3-1/4
YS48	2000 kcmil	—	2.12	7.57	3.27	—	—	—	† L48RT (4)	Brown	34	3-3/8	

♦ Not color coded.

* Use PUADP1 adapter with U dies in 46 Series.

** P44RT for use with 46 Series tooling only. PUADP1 adapter not required.

*** The MM² conductor sizes listed are the recommendations for Class 2 conductor.

■ The maximum size for the Y35 is 400 kcmil.

▲ See tooling section of this catalog for complete tool and die listings

♦ For applications greater than 2000 Volts consult cable manufacturer for voltage stress relief instructions.

† Requires 60 Ton Series with L48RT die set.

Note: All dimensions shown are for reference only.

TYPES YS-T, YSP-T

HYLINK™ High Voltage, Tapered Ends

UL Listed 90° C, Up to 35 kV ♦



Types YS-T and YSP-T seamless high conductivity copper electro-tin plated compression HYLINK™ high voltage splices with standard barrel and tapered ends are ideally suited for higher voltage applications from 5 kV through 35 kV.

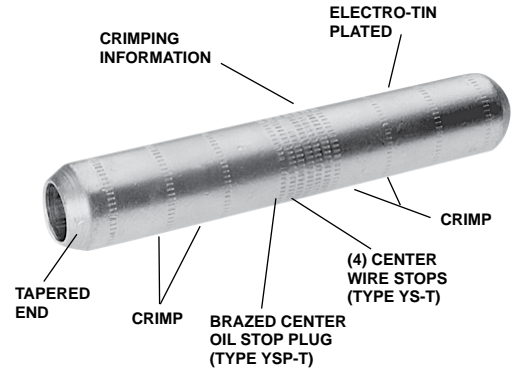

Features & Benefits

- Copper seamless barrel is designed with tapered ends per EEI Standard TD160, indicating use on voltages 5kV through 35kV; this aids in preventing corona emission and simplifies taping for lower installation cost
- Barrel also features an internal chamfer at the wire entry to ensure smooth insertion of the wire, preventing possible damage of the wire strands during insertion
- Electro-tin plated unless otherwise specified to reduce galvanic corrosion (bimetallic) and resist corrosive elements
- Short/standard length barrel is recommended for installations with limited space requirements
- Type YS-T barrel has center stop indentations used to indicate when wire is fully inserted into each side of the barrel
- Type YSP-T barrel has a center plug permanently brazed in place; this plug prevents oil within oil filled conductor from passing through the splice connector and is also an indication when the wire is fully inserted into each side of the barrel
- Connectors are clearly marked with color coding to ensure proper die and installation tooling is selected
- BURNDY certifies its products using the BURNDY Engineered System and select other crimp tool manufacturers in accordance with one or more of the UL categories in order to obtain a UL Listing
- Terminals and splices accommodating code wire: Accommodates Code Class B (Concentric, Compressed, Compact) and Class C wire

CENTER OIL STOP

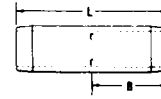

YS-T

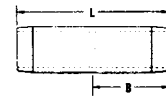

YSP-T

Accessories

- Hardware - Section F
- PENETROX™ Oxide Inhibitor - Section F
- Heat and Cold Shrink Tubing - Section D
- WIREMIKE™ Wire Micrometer - Section F
- Wire Management (Cable Ties) - Section G

Catalog Number		Code Conductors (B, C)	Dimensions		Installation Tooling- Nest/Indentor ▲					
					Y34B Y34PR Indentor	35, 750 Series, Y34PR Indentor Y35P3 Adaptor	35, 750, 46* Series Die Number (# of crimps per end)	Die Index ▲	No. of Indent	Wire Strip Length
YS-T	YSP-T		B	L	Nest Die	Nest Die				
YS6CT	—	6 AWG	0.90	2.16	B6CD	U6CD1	U5CRT (2)	7	1	15/16
YS4CT	YSP4CT	4 AWG	0.90	2.16	B4CD	U4CD1	U4CRT (2)	8	1	15/16
YS2CT	YSP2CT	2 AWG	0.98	2.34	B2CD	U2D1	U2CRT (2)	10	1	1
YS1CT	YSP1CT	1 AWG	0.97	2.31	B1CD	U1D1	U1CRT1 (2)	11	1	1
YS25T	YSP25T	1/0 AWG	0.98	2.35	B25D	U25D1	U25RT (2)	12	1	1-3/32
YS26T	YSP26T	2/0 AWG	1.04	2.47	B26D	U26D1	U26RT (2)	13	1	1-3/32
YS28T	YSP28T	4/0 AWG	1.13	2.67	B28D	U28D1	U28RT (2)	15	1	1-3/16
YS29T	YSP29T	250 kcmil	1.21	2.85	B29D	U29D1	U29RT (2)	16	1	1-3/32
YS30T	YSP30T	300 kcmil	1.22	2.87	B30D	U30D1	U30RT (4)	17	2	1-5/16
YS31T	YSP31T	350 kcmil	1.32	3.09	B31D	U31D1	U31RT (4)	18	2	1-3/5
YS34T	YSP34T	500 kcmil	1.68	3.86	No Die Needed	U34D1	U34RT (4)	20	2	1-3/4
YS39T	YSP39T	750 kcmil	2.00	4.60	—	—	U39RT (4)	24	2	2-1/8

* Use adapter PUADP1 with U Dies in 46 Series. 46 Series uses the same nest indentor and adapter as the 35 and 750 Series, but with the PUADP1 adapter.

** A 0.06 radius at each end is used for sizes 6-27.

■ The maximum size for the 35 Series is 400 kcmil.

▲ See tooling section of this catalog for complete tool and die listings.

♦ For applications greater than 2000 Volts consult cable manufacturer for voltage stress relief instructions.

Note: All dimensions shown are for reference only.

TYPES YSV-LFX, YS-LFX

HYLINK™



UL Listed 90° C, Up to 35 kV ♦

Types YSV-LFX and YS-LFX standard barrel splices for flex conductor accommodate a wide range of conductor types. Feature an internal chamfer at wire entry site to provide a smooth insertion of wire. UL486A-486B Listed and CSA Certified; UL Listed 90°C, up to 35kV.



Features & Benefits

- Connector: Uninsulated copper compression splice made from seamless copper tubing
- Connection: The connection made is irreversible and maintenance free
- UL486A-486B Listed and CSA Certified
- Temperature and Voltage Rating: UL Listed 90°C, up to 35kV
- Conductor Accommodate Types: *See table for specifics
- Code Copper Wire: Class B (Concentric, Compressed, Compact) or Class C Solid Copper Wire
- Flexible Copper Wire Classes
- Metric Class 2: Metric wire stranding
- Connectors are tin plated unless otherwise specified. Other plating suffixes: Nickel (NK), Silver (SV), Tin-Zinc (TZ), Bare (BR)
- Connectors are clearly marked with wire size, die index, color code and crimp location bands
- Barrel is designed with an internal chamfer at the wire entry to ensure smooth insertion of the wire
- Short/Standard/Light Duty Barrel is recommended for installations with limited space requirements
- In order to obtain a UL Listing and CSA Certification, BURNDY certifies its products using the BURNDY Engineered System. BURNDY connectors can receive a UL Listing and CSA Certification with other crimp tool manufacturers installation tools

Accessories

- Hardware - Section F
- PENETROX™ Oxide Inhibitor - Section F
- Heat and Cold Shrink Tubing - Section D
- WIREMIKE™ Wire Micrometer - Section F
- Wire Management (Cable Ties) - Section G

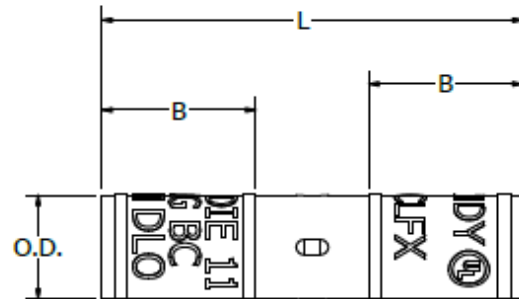

Figure 1

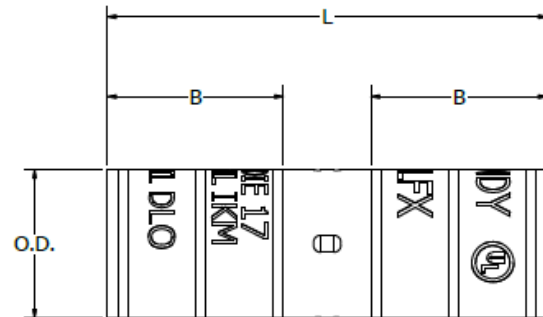

Figure 2

TYPES YSV-LFX, YS-LFX

HYLINK™



UL Listed 90° C, Up to 35 kV ♦

Types YSV-LFX and YS-LFX standard barrel splices for flex conductor accommodate a wide range of conductor types. Feature an internal chamfer at wire entry site to provide a smooth insertion of wire. UL486A-486B Listed and CSA Certified; UL Listed 90°C, up to 35kV.



▲ See Copper Flex Standard Barrel Splice Tooling Table and Instructions in this section for complete tool and die listing information.

Catalog Number	Figure #	Code Conductor (B/C)	Flex Conductor (G, H, I, K, M, DLO)	Metric Conductor (MM²)	Color Code	Die Index	Dimensions			Wire Strip Length
							Outside Diameter (OD)	Barrel Length (B)	Overall Length (L)	
YS8CLBOX	1	#8 AWG	#8 AWG G,H,I,K,M,DLO	10	Red	49	0.27	0.44	1.00	1/2
YSV6CLFX		#6 AWG	#6 AWG G,H,I,K,M,DLO	16	Blue	7	0.31	0.78	1.75	7/8
YSV4CLFX		#4 AWG	#4 AWG G,H,I,K,M,DLO	—	Gray	8	0.38	0.84	2.05	7/8
YSV3CLFX		#3 AWG	#3 AWG G,H,I,K,M,DLO	—	White	9	0.42	0.84	2.00	1
YSV2CLFX		#2 AWG	#2 AWG G,H,I,K,M,DLO	35	Brown	10	0.46	0.84	2.06	1
YSV1CLFX		#1 AWG	#1 AWG G,H,I,K,M,DLO	—	Green	11	0.51	0.84	2.08	1
YSV25LFX		1/0 AWG	1/0 AWG G,H,I,K,M,DLO	50	Pink	12	0.56	0.89	2.17	1
YSV26LFX		2/0 AWG	2/0 AWG G,H,I,K,M,DLO	70	Black	13	0.63	0.89	2.17	1
YSV27LFX		3/0 AWG	3/0 AWG G,H,I,K,M,DLO	95	Orange	14	0.70	0.89	2.17	1-1/8
YSV28LFX		4/0 AWG	4/0 AWG G,H,I,K,M,DLO	120	Purple	15	0.77	0.89	2.17	1-1/8
YSV29LFX		250 kcmil	4/0 AWG G,H,I,K,M,DLO	—	Yellow	16	0.80	0.89	2.17	1-1/8
YS30LFX		2	—	250 kcmil G,H	—	Yellow	16	0.81	1.02	2.47
YS31LFX	—		250 kcmil I,K,M 262 DLO	150	White	17	0.88	1.08	2.60	1-1/4
YS32LFX	—		300 kcmil G,H,I,K,M 313 DLO	185	Red	18	0.95	1.14	2.74	1-1/4
YS34LFX	—		350 kcmil G,H,I,K,M 373 DLO	240	Blue	19	1.06	1.33	3.15	1-1/2
YS36LFX	—		500 kcmil G&H 444 DLO	—	Brown	20	1.19	1.31	3.22	1-1/2
YS38LFX	—		500 kcmil H,I,K, 550 kcmil G,H,I 535 DLO	300	Pink	L99	1.25	1.31	3.22	1-1/2
YS40LFX	—		650 kcmil G 646 DLO	400	Black	24	1.35	1.56	3.75	1-5/8
YS44LFX	—		750 kcmil G,H,I 777 DLO	500	Yellow	L115	1.50	1.81	4.28	2

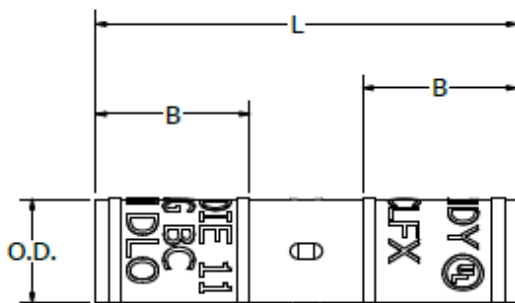

Figure 1

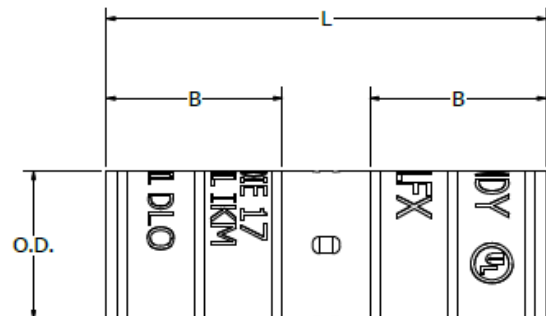

Figure 2

Compression Connections

Copper Flex Standard Barrel Splice Tooling Table
Mechanical/Ratchet (Dedicated Die or Requiring Dies)

Catalog Number Type	Wire Size	Color Code and Die Index Number	Mechanical & Ratchet Dies Required (# Crimps)		Mechanical & Ratchet Dedicated Die Tools # Crimps				
	Copper		MD6 and MD7 Series <small>*Due to handle force not recommended</small>	OUR840 <small>*Due to handle force not recommended</small>	MY28 and MY29 Series	MRC840	MRE1022B Y8MRB1 Y10D Y1022	Y122CMR	Y1MRTC
YS8CLBOX	#8 AWG B,C,G,H,I,K,M DLO #6 Sol #8 Sol	RED 49	X8CRT (1) W8CRT (1) W8CVT (1)	X8CRT (1) W8CRT (1) W8CVT (1)	1 CRIMP	1 CRIMP	—	1 CRIMP	1 CRIMP
YSV6CLFX	#6 AWG B,C,G,H,I,K,M DLO	BLUE 7	X5CRT (1) W5CRT (1) W5CVT (1)	X5CRT (1)	1 CRIMP	1 CRIMP	—	1 CRIMP	1 CRIMP
YSV4CLFX	#4 AWG B,C,G,H,I,K,M DLO	GRAY 8	X4CRT (1) W4CRT (1) W4CVT (1)	X4CRT (1)	1 CRIMP	1 CRIMP	—	2 CRIMPS	2 CRIMPS
YSV3CLFX	#3 AWG B,C,G,H,I,K,M DLO	WHITE 9	W3CRT (1)	—	1 CRIMP	1 CRIMP	—	2 CRIMPS	2 CRIMPS
YSV2CLFX	#2 AWG B,C,G,H,I,K,M DLO	BROWN 10	X2CRT (1) W2CRT (1) W2CVT (1)	X2CRT (1)	1 CRIMP	1 CRIMP	—	2 CRIMPS	2 CRIMPS
YSV1CLFX	#1 AWG B,C,G,H,I,K,M DLO	GREEN 11	X1CRT1 (1) W1CRT1 (1) W1CVT (1)	X1CRT1 (1)	1 CRIMP	1 CRIMP	—	—	—
YSV25LFX	1/0 AWG B,C,G,H,I,K,M DLO	PINK 12	X25RT (2) W25RT (2) W25VT (2)	X25RT (2) W25RT (2)* W25VT (2)*	1 CRIMP	2 CRIMPS	—	—	—
YSV26LFX	2/0 AWG B,C,G,H,I,K,M DLO	BLACK 13	X26RT (2) W26RT (2) W26VT (2)	X26RT (2) W26RT (2)* W26VT (2)*	1 CRIMP	2 CRIMPS	—	—	—
YSV27LFX	3/0 AWG B,C,G,H,I,K,M DLO	ORANGE 14	X27RT (3) W27RT (2) W27VT (2)	X27RT (3) W27RT (2)* W27VT (2)*	1 CRIMP	2 CRIMPS	—	—	—
YSV28LFX	4/0 AWG B,C,G,H,I,K,M DLO	PURPLE 15	X28RT (3) W28RT (2) W28VT (2)	X28RT (3) W28RT (2)* W28VT (2)*	1 CRIMP	2 CRIMPS	—	—	—
YSV29LFX	4/0 AWG G,H,I,K,M DLO 250 kcmil B,C	YELLOW 16	X29RT (4) W29RT (2) W29VT (2)	X29RT (4) W29RT (2)* W29VT (2)*	1 CRIMP	—	—	—	—
YS30LFX	250 kcmil G, H	YELLOW 16	X29RT (4) W29RT (2)* W29VT (2)	X29RT (4) W29RT (2)* W29VT (2)*	—	—	—	—	—
YS31LFX	250 kcmil I,K,M 262 DLO	WHITE 17	W30RT (2)* W30VT (2)	—	—	—	—	—	—
YS32LFX	300 kcmil G,H,I,K,M 313 DLO	RED 18	W31RT (2)* W31VT (2)	—	—	—	—	—	—
YS34LFX	350 kcmil G,H,I,K,M 373 DLO	BLUE 19	W32RT (2)* W32VT (2)	—	—	—	—	—	—

*Due to handle force not recommended.

Catalog Number Type	Wire Size	Color Code and Die Index Number	Hydraulic Tools - Dies Required (# Crimps)					Hydraulic Tools - Dieless	
	Copper		MD6, 600, 500 Series	750, 35 Series	45 Series <i>Use PT6515 with U Dies</i>	46 Series <i>Use PUADP1 with U Dies</i>	60 Series	81K 4PC Series	644 444 Series
YS8CLBOX	#8 AWG B,C,G,H,I,K,M DLO #6 Sol #8 Sol	RED 49	X8CRT (1) W8CRT (1) W8CVT (1)	U8CRT (1)	U8CRT (1)	U8CRT (1)	—	1 CRIMP	—
YSV6CLFX	#6 AWG B,C,G,H,I,K,M DLO #6 Str #6 Sol	BLUE 7	X5CRT (1) W5CRT (1) W5CVT (1)	U5CRT (1)	U5CRT (1)	U5CRT (1)	—	1 CRIMP	—
YSV4CLFX	#4 AWG B,C,G,H,I,K,M DLO	GRAY 8	X4CRT (1) W4CRT (1) W4CVT (1)	U4CRT (1)	U4CRT (1)	U4CRT (1)	—	1 CRIMP	—
YSV3CLFX	#3 AWG B,C,G,H,I,K,M DLO	WHITE 9	W3CRT (1)	U3CRT (1)	U3CRT (1)	U3CRT (1)	—	1 CRIMP	—
YSV2CLFX	#2 AWG B,C,G,H,I,K,M DLO	BROWN 10	X2CRT (1) W2CRT (1) W2CVT (1)	U2CRT (1)	U2CRT (1)	U2CRT (1)	—	1 CRIMP	1 CRIMP
YSV1CLFX	#1 AWG B,C,G,H,I,K,M DLO	GREEN 11	X1CRT1 (1) W1CRT1 (1) W1CVT (1)	U1CRT1 (1)	U1CRT1 (1)	U1CRT1 (1)	—	1 CRIMP	1 CRIMP
YSV25LFX	1/0 AWG B,C,G,H,I,K,M DLO	PINK 12	X25RT (2) W25RT (2) W25VT (2)	U25RT (1)	U25RT (1)	U25RT (1)	—	1 CRIMP	1 CRIMP
YSV26LFX	2/0 AWG B,C,G,H,I,K,M DLO	BLACK 13	X26RT (2) W26RT (2) W26VT (2)	U26RT (1)	U26RT (1)	U26RT (1)	—	1 CRIMP	1 CRIMP
YSV27LFX	3/0 AWG B,C,G,H,I,K,M DLO	ORANGE 14	X27RT (3) W27RT (2) W27VT (2)	U27RT (1)	U27RT (1)	U27RT (1)	—	1 CRIMP	1 CRIMP
YSV28LFX	4/0 AWG B,C,G,H,I,K,M DLO	PURPLE 15	X28RT (3) W28RT (2) W28VT (2)	U28RT (1)	U28RT (1)	U28RT (1)	L28RT (1)	1 CRIMP	1 CRIMP
YSV29LFX	4/0 AWG G,H,I,K,M DLO 250 kcmil B,C	YELLOW 16	X29RT (4) W29RT (2) W29VT (2)	U29RT (1)	U29RT (1)	U29RT (1)	L29RT (1)	1 CRIMP	1 CRIMP
YS30LFX	250 kcmil G, H	YELLOW 16	X29RT (4) W29RT (2) W29VT (2)	U29RT (1)	U29RT (1)	U29RT (1)	L30RT (1)	1 CRIMP	1 CRIMP
YS31LFX	250 kcmil I,K,M 262 DLO	WHITE 17	W30RT (2) W30VT (2)	U30RT (2)	U30RT (2)	U30RT (2)	L31RT (1)	1 CRIMP	1 CRIMP
YS32LFX	300 kcmil G,H,I,K,M 313 DLO	RED 18	W31RT (2) W31VT (2)	U31RT (2)	U31RT (2)	U31RT (2)	L32RT (1)	1 CRIMP	1 CRIMP
YS34LFX	350 kcmil G,H,I,K,M 373 DLO	BLUE 19	W32RT (2) W32VT (2)	U32RT (2)	U32RT (2)	U32RT (2)	L34RT (1)	1 CRIMP	1 CRIMP

Compression Connections

Copper Flex Standard Barrel Splice Tooling Table Hydraulic Requiring Dies and Dieless

Catalog Number Type	Wire Size	Color Code and Die Index Number	Hydraulic Tools - Dies Required (# Crimps)					Hydraulic Tools - Dieless	
	Copper		MD6, 600, 500 Series	750, 35 Series	45 Series <i>Use PT6515 with U Dies</i>	46 Series <i>Use PUADP1 with U Dies</i>	60 Series	81K 4PC Series	644 444 Series
YS36LFX	500 kcmil G,H 444 DLO	BROWN 20	—	U34RT (2)	U34RT (2)	U34RT (2)	L36RT (1)	1 CRIMP	1 CRIMP
YS38LFX	500 kcmil H,I,K 550 kcmil G,H,I 535 DLO	PINK L99	—	U38XRT (2)	U38XRT (2)	U38XRT (2)	L38RT (1)	1 CRIMP	1 CRIMP
YS40LFX	650 kcmil G 646 DLO	BLACK 24	—	U39RT (2)	U39RT (2)	U39RT (2)	L40RT (1)	2 OVERLAPPING CRIMPS*	1 CRIMP
YS44LFX	750 kcmil G,H,I 777 DLO	YELLOW L115	—	U44XRT (2)	U44XRT (2)	U44XRT (2) P44XRT (2)	L44RT (2)	2 OVERLAPPING CRIMPS*	1 CRIMP

*Some catalog numbers require overlapping crimps when using the 81K or 4PC series of installation tooling. Please refer to the overlapping crimps image below. Overlap each consecutive crimp so that the completed installation of all overlapping crimps covers the entire crimp zone.

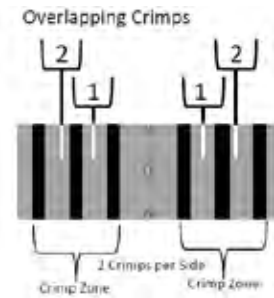

Installation Instructions

Installation instructions help the installer understand proper wire preparation, proper insertion requirements, crimp zone location, individual crimp location, crimp order and crimp direction, to ensure safe and reliable wire connections. UL Listing and CSA Certification are only valid when using the BURNDY® Engineered System and following BURNDY Installation Instructions.

Copper Flex Standard Barrel Splice Installation Steps:

1. Select the appropriate connector based on:
 - Wire Material
 - Wire Construction
 - Wire Size
2. Strip the insulation to the appropriate wire strip length, based on the table's Wire Strip Length recommendation for the selected connector. Due to tolerances in the connector, wire strip length, and insulation stripping tools, this range may be 0" - 1/4". The exposed wire, also known as a "shiner", has no performance impact on the connection and there is no wire exposure requirement by BURNDY.
3. As a best practice, wire brush the bare conductor to remove any oxides. DO NOT wire brush tin-plated connectors.
4. Insert the conductor into the barrel until flush against the conductor stops halfway into the splice connector.
5. Apply the proper number of crimps specified by the appropriate illustration for the side with conductor inserted.
6. *Some catalog numbers require overlapping crimps when using the 81K or 4PC series of installation tooling. Please refer to the overlapping crimps image. Overlap each consecutive crimp so that the completed installation of overlapping crimps covers the entire crimp zone.
7. Use the same steps 2-6 for the other side of the splice.
8. Once all crimps have been completed, the connection can be easily inspected for proper installation with the die/indicia embossment.

NOTE: Illustrations show black bands however this is just a representation of the crimp zones. See individual connector for actual crimp band color.

Example: YSV26LFX

- Go to the YSV26LFX Catalog Number Designation for 2/0 AWG G,H,I,K,M or DLO.
- Confirm the Tool (750 Series for this example).
- Confirm the Die Set Needed (U26RT for this example)
- Confirm the Number of Crimps Necessary (1 each side for this example)
- For proper crimp placement refer to the image on this page corresponding to the number of crimps.

The BURNDY® Engineered System:



Splice

750 Series Tool

Die Set

Completed Crimp Installation

CATALOG NUMBER DESIGNATIONS

YS8CLBOX	YSV6CLFX	YSV4CLFX
YSV3CLFX	YSV2CLFX	YSV1CLFX
YSV25LFX	YSV26LFX	YSV27LFX
YSV28LFX	YSV29LFX	

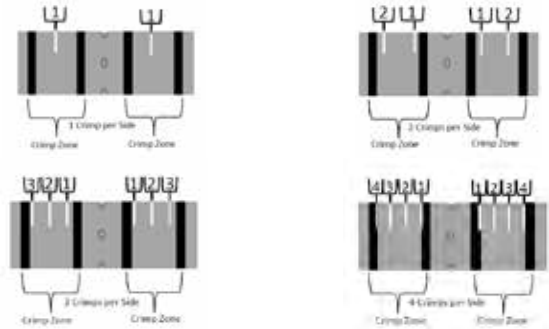

CATALOG NUMBER DESIGNATIONS

YS30LFX	YS31LFX	YS32LFX	YS34LFX
YS36LFX	YS38LFX	YS40LFX*	YS44LFX*

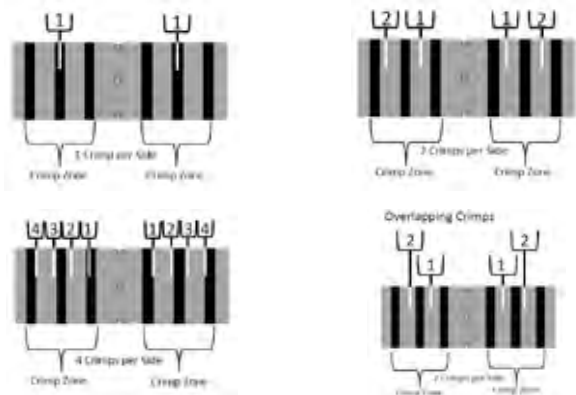

TYPES YSV-FX, YS-FX

HYLINK™



UL Listed 90° C, Up to 35 kV ♦

Types YSV-FX and YS-FX long barrel splices for flex conductor accommodate a wide range of conductor types. Feature an internal chamfer at wire entry site to provide a smooth insertion of wire. UL486A-486B Listed and CSA Certified; UL Listed 90°C, up to 35kV.



Features & Benefits

- Connector: Uninsulated copper compression splice made from seamless copper tubing
- Connection: The connection made is irreversible and maintenance free
- UL486A-486B Listed and CSA Certified
- Temperature and Voltage Rating: UL Listed 90°C, up to 35kV
- Conductor Accommodate Types: *See table for specifics
- Code Copper Wire: Class B (Concentric, Compressed, Compact) or Class C
- Solid Copper Wire
- Flexible Copper Wire Classes
- Metric Class 2: Metric wire stranding
- Connectors are tin plated unless otherwise specified. Other plating suffixes: Nickel (NK), Silver (SV), Tin-Zinc (TZ), Bare (BR)
- Connectors are clearly marked with wire size, die index, color code and crimp location bands
- Barrel is designed with an internal chamfer at the wire entry to ensure smooth insertion of the wire
- Long barrel allows an increased number of crimps, increasing the mechanical strength of the connection
- In order to obtain a UL Listing and CSA Certification, BURNDY certifies its products using the BURNDY Engineered System. BURNDY connectors can receive a UL Listing and CSA Certification with other crimp tool manufacturers installation tools

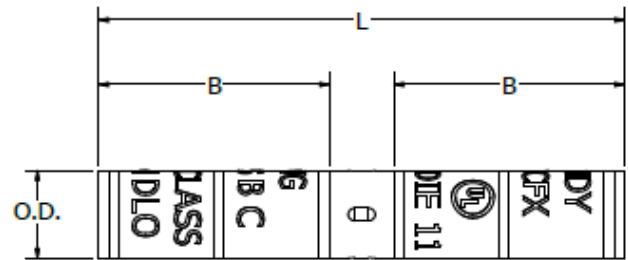

Figure 1

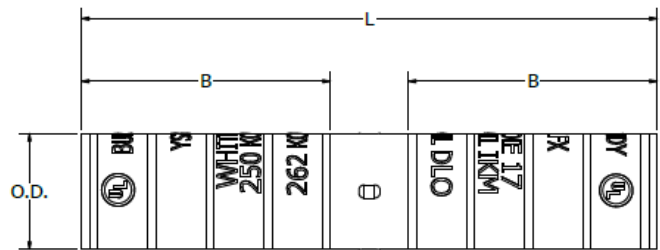

Figure 2

Accessories

- Hardware - Section F
- PENETROX™ Oxide Inhibitor - Section F
- Heat and Cold Shrink Tubing - Section D
- WIREMIKE™ Wire Micrometer - Section F
- Wire Management (Cable Ties) - Section G

TYPES YSV-FX, YS-FX

HYLINK™



UL Listed 90° C, Up to 35 kV ♦

Types YSV-FX and YS-FX long barrel splices for flex conductor accommodate a wide range of conductor types. Feature an internal chamfer at wire entry site to provide a smooth insertion of wire. UL486A-486B Listed and CSA Certified; UL Listed 90°C, up to 35kV.



▲ See Copper Flex Long Barrel Splice Tooling Table and Instructions in this section for complete tool and die listing information.

Catalog Number	Figure #	Code Conductor (B/C)	Flex Conductor (G, H, I, K, M, DLO)	Metric Conductor (MM ²)	Color Code	Die Index	Dimensions			Wire Strip Length	
							Outside Diameter (OD)	Barrel Length (B)	Overall Length (L)		
YS8C	1	#8 AWG	#8 AWG G,H,I,K,M,DLO	10	Red	49	0.27	0.78	1.75	7/8	
YSV6CFX		#6 AWG	#6 AWG G,H,I,K,M,DLO	16	Blue	7	0.31	1.09	2.53	1-1/4	
YSV4CFX		#4 AWG	#4 AWG G,H,I,K,M,DLO	—	Gray	8	0.38	1.22	2.80	1-1/4	
YSV3CFX		#3 AWG	#3 AWG G,H,I,K,M,DLO	—	White	9	0.42	1.22	2.82	1-3/8	
YSV2CFX		#2 AWG	#2 AWG G,H,I,K,M,DLO	35	Brown	10	0.46	1.34	3.06	1-1/2	
YSV1CFX		#1 AWG	#1 AWG G,H,I,K,M,DLO	—	Green	11	0.51	1.34	3.08	1-1/2	
YSV25FX		1/0 AWG	1/0 AWG G,H,I,K,M,DLO	50	Pink	12	0.56	1.45	3.30	1-5/8	
YSV26FX		2/0 AWG	2/0 AWG G,H,I,K,M,DLO	70	Black	13	0.63	1.45	3.30	1-5/8	
YSV27FX		3/0 AWG	3/0 AWG G,H,I,K,M,DLO	95	Orange	14	0.70	1.45	3.30	1-5/8	
YSV28FX		4/0 AWG	4/0 AWG G,H,I,K,M,DLO	120	Purple	15	0.77	1.45	3.30	1-5/8	
YSV29FX		250 kcmil	4/0 AWG G,H,I,K,M,DLO	—	Yellow	16	0.80	1.45	3.30	1-5/8	
YS30FX		2	—	250 kcmil G,SH	—	Yellow	16	0.81	1.95	4.34	2-1/8
YS31FX			—	250 kcmil I,K,M, 262 DLO	150	White	17	0.88	1.95	4.35	2-1/8
YS32FX	—		300 kcmil G,H,I,K,M 313 DLO	185	Red	18	0.95	2.08	4.62	2-1/4	
YS34FX	—		350 kcmil G,H,I,K,M 373 DLO	240	Blue	19	1.06	2.20	4.91	2-1/4	
YS36FX	—		500 kcmil G&H 444 DLO	—	Brown	20	1.19	2.63	5.85	2-3/4	
YS38FX	—		500 kcmil H,I,K 550 kcmil G,H,I 535 DLO	300	Pink	L99	1.25	2.75	6.10	2-7/8	
YS40FX	—		650 kcmil G 646 DLO	400	Black	24	1.35	2.88	6.38	3	
YS44FX	—		750 kcmil G,H,I 777 DLO	500	Yellow	L115	1.50	2.94	6.53	3-1/8	

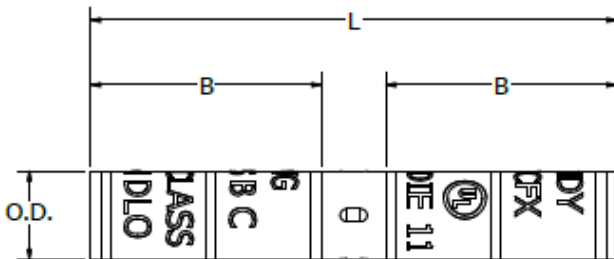

Figure 1

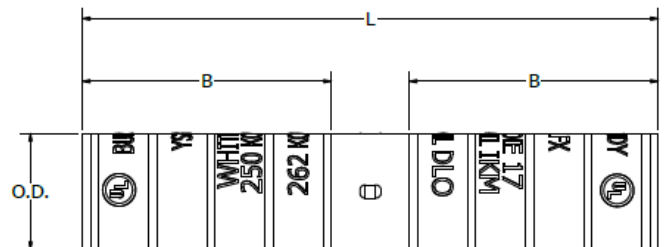

Figure 2

Compression Connections

Copper Flex Long Barrel Splice Tooling Table Mechanical/Ratchet (Dedicated Die or Requiring Dies)

Catalog Number Type	Wire Size	Color Code and Die Index Number	Mechanical & Ratchet Dies Required (# Crimps)		Mechanical & Ratchet Dedicated Die Tools # Crimps				
	Copper		MD6 and MD7 Series <small>*Due to handle force not recommended</small>	OUR840 <small>*Due to handle force not recommended</small>	MY28 and MY29 Series	MRC840	MRE1022B Y8MRB1 Y10D Y1022	Y122CMR	Y1MRTC
YS8C	#8 AWG B,C,G,H,I,K,M DLO #6 Sol #8 Sol	RED 49	X8CRT (2) W8CRT (2) W8CVT (2)	X8CRT (2) W8CRT (2) W8CVT (2)	2 CRIMPS	2 CRIMPS	—	2 CRIMPS	2 CRIMPS
YSV6CFX	#6 AWG B,C,G,H,I,K,M DLO	BLUE 7	X5CRT (2) W5CRT (2) W5CVT (2)	X5CRT (2)	2 CRIMPS	2 CRIMPS	—	1 CRIMP	1 CRIMP
YSV4CFX	#4 AWG B,C,G,H,I,K,M DLO	GRAY 8	X4CRT (2) W4CRT (2) W4CVT (2)	X4CRT (2)	2 CRIMPS	2 CRIMPS	—	4 CRIMPS	4 CRIMPS
YSV3CFX	#3 AWG B,C,G,H,I,K,M DLO	WHITE 9	W3CRT (2)	W3CRT (2)	2 CRIMPS	2 CRIMPS	—	4 CRIMPS	4 CRIMPS
YSV2CFX	#2 AWG B,C,G,H,I,K,M DLO	BROWN 10	X2CRT (2) W2CRT (2) W2CVT (2)	X2CRT (2)	2 CRIMPS	2 CRIMPS	—	4 CRIMPS	4 CRIMPS
YSV1CFX	#1 AWG B,C,G,H,I,K,M DLO	GREEN 11	X1CRT1 (2) W1CRT1 (2) W1CVT (2)	X1CRT1 (2)	2 CRIMPS	2 CRIMPS	—	—	—
YSV25FX	1/0 AWG B,C,G,H,I,K,M DLO	PINK 12	X25RT (4) W25RT (4) W25VT (4)	X25RT (4) W25VT (4)*	2 CRIMPS	4 CRIMPS	—	—	—
YSV26FX	2/0 AWG B,C,G,H,I,K,M DLO	BLACK 13	X26RT (4) W26RT (4) W26VT (4)	X26RT (4) W26VT (4)*	2 CRIMPS	4 CRIMPS	—	—	—
YSV27FX	3/0 AWG B,C,G,H,I,K,M DLO	ORANGE 14	X27RT (4) W27RT (4) W27VT (4)	X27RT (4) W27VT (4)*	2 CRIMPS	4 CRIMPS	—	—	—
YSV28FX	4/0 AWG B,C,G,H,I,K,M DLO	PURPLE 15	X28RT (6) W28RT (4) W28VT (4)	X28RT (6) W28VT (4)*	2 CRIMPS	4 CRIMPS	—	—	—
YSV29FX	4/0 AWG G,H,I,K,M DLO 250 kcmil B,C	YELLOW 16	X29RT (8) W29RT (4) W29VT (4)	X29RT (8) W29VT (4)*	2 CRIMPS	—	—	—	—
YS30FX	250 kcmil G, H	YELLOW 16	X29RT (4) W29RT (4)* W29VT (4)	X29RT (8) W29VT (4)*	—	—	—	—	—
YS31FX	250 kcmil I,K,M 262 DLO	WHITE 17	W30VT (4)	—	—	—	—	—	—
YS32FX	300 kcmil G,H,I,K,M 313 DLO	RED 18	W31VT (4)	—	—	—	—	—	—
YS34FX	350 kcmil G,H,I,K,M 373 DLO	BLUE 19	W32VT (4)	—	—	—	—	—	—

*Due to handle force not recommended.

Catalog Number Type	Wire Size	Color Code and Die Index Number	Hydraulic Tools - Dies Required (# Crimps)					Hydraulic Tools - Dieless	
	Copper		MD6, 600, 500 Series	750, 35 Series	45 Series <i>Use PT6515 with U Dies</i>	46 Series <i>Use PUADP1 with U Dies</i>	60 Series	81K 4PC Series	644 444 Series
YS8C	#8 AWG B,C,G,H,I,K,M DLO #6 Sol #8 Sol	RED 49	X8CRT (2) W8CRT (2) W8CVT (2)	U8CRT (2)	U8CRT (2)	U8CRT (2)	—	1 CRIMP	—
YSV6CFX	#6 AWG B,C,G,H,I,K,M DLO #6 Str #6 Sol	BLUE 7	X5CRT (2) W5CRT (2) W5CVT (2)	U5CRT (2)	U5CRT (2)	U5CRT (2)	—	1 CRIMP	—
YSV4CFX	#4 AWG B,C,G,H,I,K,M DLO	GRAY 8	X4CRT (2) W4CRT (2) W4CVT (2)	U4CRT (2)	U4CRT (2)	U4CRT (2)	—	1 CRIMP	—
YSV3CFX	#3 AWG B,C,G,H,I,K,M DLO	WHITE 9	W3CRT (2)	U3CRT (2)	U3CRT (2)	U3CRT (2)	—	2 CRIMPS	—
YSV2CFX	#2 AWG B,C,G,H,I,K,M DLO	BROWN 10	X2CRT (2) W2CRT (2) W2CVT (2)	U2CRT (2)	U2CRT (2)	U2CRT (2)	—	2 CRIMPS	1 CRIMP
YSV1CFX	#1 AWG B,C,G,H,I,K,M DLO	GREEN 11	X1CRT1 (2) W1CRT1 (2) W1CVT (2)	U1CRT1 (2)	U1CRT1 (2)	U1CRT1 (2)	—	2 CRIMPS	1 CRIMP
YSV25FX	1/0 AWG B,C,G,H,I,K,M DLO	PINK 12	X25RT (4) W25RT (4) W25VT (4)	U25RT (2)	U25RT (2)	U25RT (2)	—	2 CRIMPS	1 CRIMP
YSV26FX	2/0 AWG B,C,G,H,I,K,M DLO	BLACK 13	X26RT (4) W26RT (4) W26VT (4)	U26RT (2)	U26RT (2)	U26RT (2)	—	2 CRIMPS	1 CRIMP
YSV27FX	3/0 AWG B,C,G,H,I,K,M DLO	ORANGE 14	X27RT (6) W27RT (4) W27VT (4)	U27RT (2)	U27RT (2)	U27RT (2)	—	2 CRIMPS	1 CRIMP
YSV28FX	4/0 AWG B,C,G,H,I,K,M DLO	PURPLE 15	X28RT (6) W28RT (4) W28VT (4)	U28RT (2)	U28RT (2)	U28RT (2)	L28RT (1)	2 CRIMPS	1 CRIMP
YSV29FX	4/0 AWG G,H,I,K,M DLO 250 kcmil B,C	YELLOW 16	X29RT (8) W29RT (4) W29VT (4)	U29RT (2)	U29RT (2)	U29RT (2)	L29RT (1)	2 CRIMPS	1 CRIMP
YS30FX	250 kcmil G, H	YELLOW 16	X29RT (8) W29RT (4) W29VT (4)	U29RT (2)	U29RT (2)	U29RT (2)	L30RT (1)	2 CRIMPS	1 CRIMP
YS31FX	250 kcmil I,K,M 262 DLO	WHITE 17	W30RT (4) W30VT (4)	U30RT (4)	U30RT (4)	U30RT (4)	L31RT (1)	2 CRIMPS	1 CRIMP
YS32FX	300 kcmil G,H,I,K,M 313 DLO	RED 18	W31RT (4) W31VT (4)	U31RT (4)	U31RT (4)	U31RT (4)	L32RT (1)	2 CRIMPS	1 CRIMP
YS34FX	350 kcmil G,H,I,K,M 373 DLO	BLUE 19	W32RT (4) W32VT (4)	U32RT (4)	U32RT (4)	U32RT (4)	L34RT (1)	2 CRIMPS	1 CRIMP

Compression Connections

Copper Flex Long Barrel Splice Tooling Table
Hydraulic Requiring Dies and Dieless

Catalog Number Type	Wire Size	Color Code and Die Index Number	Hydraulic Tools - Dies Required (# Crimps)					Hydraulic Tools - Dieless	
	Copper		MD6, 600, 500 Series	750, 35 Series	45 Series <i>Use PT6515 with U Dies</i>	46 Series <i>Use PUADP1 with U Dies</i>	60 Series	81K 4PC Series	644 444 Series
YS36FX	500 kcmil G,H 444 DLO	BROWN 20	—	U34RT (4)	U34RT (4)	U34RT (4)	L36RT (1)	2 CRIMPS	1 CRIMP
YS38FX	500 kcmil H,I,K 550 kcmil G,H,I 535 DLO	PINK L99	—	U38XRT (4)	U38XRT (4)	U38XRT (4)	L38RT (2)	2 CRIMPS	1 CRIMP
YS40FX	650 kcmil G 646 DLO	BLACK 24	—	U39RT (4)	U39RT (4)	U39RT (4)	L40RT (1)	3 CRIMPS	1 CRIMP
YS44FX	750 kcmil G,H,I 777 DLO	YELLOW L115	—	U44XRT (4)	U44XRT (4)	U44XRT (4) P44XRT (4)	L44RT (2)	3 CRIMPS	1 CRIMP

Installation Instructions

Installation instructions help the installer understand proper wire preparation, proper insertion requirements, crimp zone location, individual crimp location, crimp order and crimp direction, to ensure safe and reliable wire connections. UL Listing and CSA Certification are only valid when using the BURNDY® Engineered System and following BURNDY Installation Instructions.

Copper Flex Long Barrel Splice Installation Steps:

1. Select the appropriate connector based on:
 - Wire Material
 - Wire Construction
 - Wire Size
2. Strip the insulation to the appropriate wire strip length, based on the table's Wire Strip Length recommendation for the selected connector. Due to tolerances in the connector, wire strip length, and insulation stripping tools, this range may be 0" - 1/4". The exposed wire, also known as a "shiner", has no performance impact on the connection and there is no wire exposure requirement by BURNDY.
3. As a best practice, wire brush the bare conductor to remove any oxides. DO NOT wire brush tin-plated connectors.
4. Insert the conductor into the barrel until flush against the conductor stops halfway into the splice connector.
5. Apply the proper number of crimps specified by the appropriate illustration for the side with conductor inserted.
6. Use the same steps 2-5 for the other side of the splice.
7. Once all crimps have been completed, the connection can be easily inspected for proper installation with the die/indicia embossment.

NOTE: Illustrations show black bands however this is just a representation of the crimp zones. See individual connector for actual crimp band color.

Example: YSV26FX

- Go to the YSV26FX Catalog Number Designation for 2/0 AWG G,H,I,K,M or DLO.
- Confirm the Tool (750 Series for this example).
- Confirm the Die Set Needed (U26RT for this example)
- Confirm the Number of Crimps Necessary (2 each side for this example)
- For proper crimp placement refer to the image on this page corresponding to the number of crimps.

The BURNDY® Engineered System:



Splice



750 Series Tool



Die Set



Completed Crimp Installation

CATALOG NUMBER DESIGNATIONS

YS8C	YSV6CFX	YSV4CFX	YSV3CFX
YSV2CFX	YSV1CFX	YSV25FX	YSV26FX
YSV27FX	YSV28FX	YSV29FX	

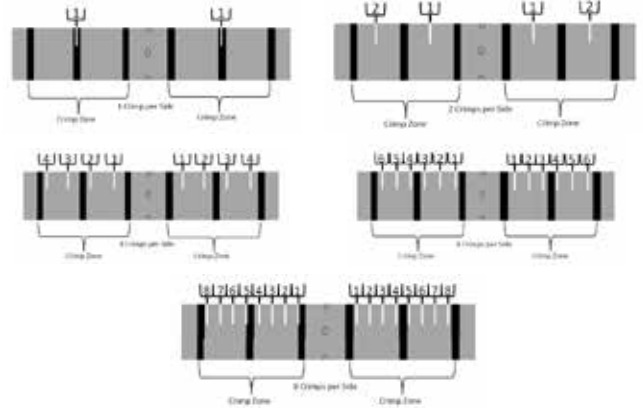

CATALOG NUMBER DESIGNATIONS

YS30FX	YS31FX	YS32FX	YS34FX
YS36FX	YS38FX	YS40FX	YS44FX

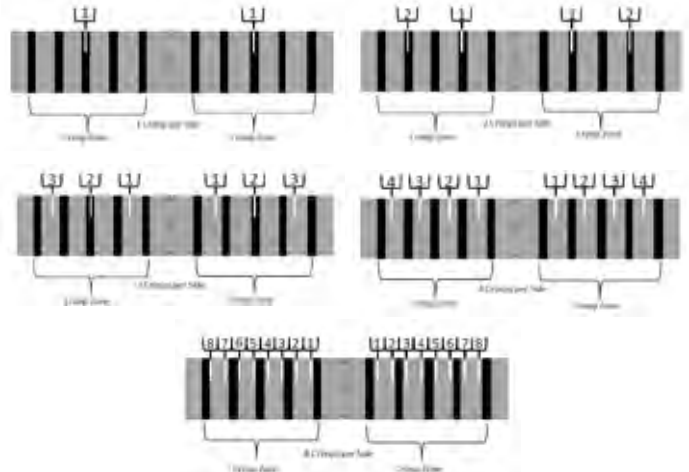

TYPE YS-TC

HYSPLICE™ In-Line Splice Kits Standard Barrel, with Inspection Window

Type YS-TC kits are for splicing cables and covering the connection with clear heat shrink. Splices are constructed from seamless, high conductivity electrolytic copper tubing for maximum conductivity and tin-plated to resist corrosion. Each YS-TC splice is provided with inspection holes and cable stops. The YS-TC family also features the BURNDY Engineered System of coordinated tools and dies.

Features & Benefits

- Each splice kit includes one YS-TC compression splice connector and heat shrink
- The YS-TC type compression splice connector provided in the kit is UL Listed in accordance with UL 486A-486B - Wire Connectors; UL Listed 90°C up to 35kV
- Barrels have 2 inspection windows on each side to allow for visual verification that the wire has been fully inserted prior to crimping the splice
- Barrel is designed with an internal chamfer at the wire entry to ensure smooth insertion of the wire, preventing possible damaging of the wire strands during insertion
- Electro-tin plated unless otherwise specified to reduce galvanic corrosion (bimetallic) and resist corrosive elements
- Short/standard length barrel is recommended for installations with limited space requirements and meet the exact UL testing requirements as long barrel connectors so performance of the connection is not compromised
- Connectors clearly marked with color coding

Accessories

- Hardware - Section F
- PENETROX™ Oxide Inhibitor - Section F
- Heat and Cold Shrink Tubing - Section D
- WIREMIKE™ Wire Micrometer - Section F
- Wire Management (Cable Ties) - Section G

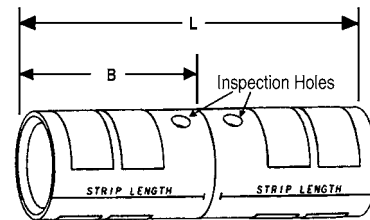
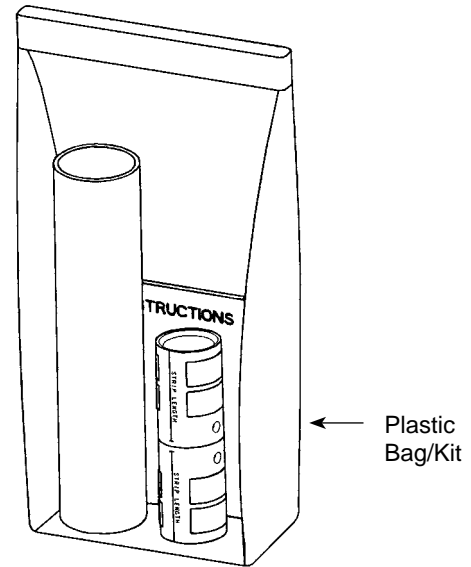

TYPE YS-TC (Continued)

HYREDUCER™ In-Line Standard Barrel
Splice Kits with Inspection Window

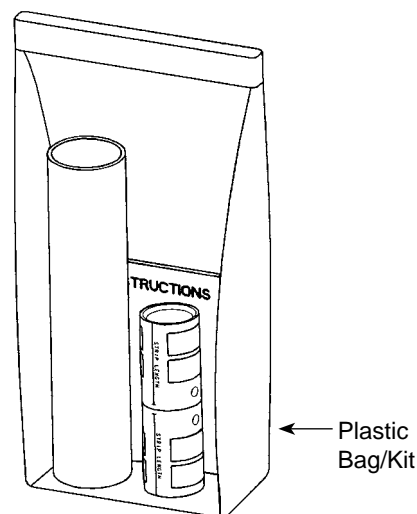

Clear Heat Shrink Kit Catalog Number	Wire Size		Barrel Type	Connector				Wire Strip Length
	AWG	mm ²		Dimensions		Color Code	Die Index	
				Barrel B	Length L			
YS44FXLTCKITC	750 kcmil G,H DLO 777 (1925/24)	500 mm ² Class 5	Standard	1.90	4.30	Yellow	L115	1.96
YS39LTCKITC	750 kcmil Code	—	Standard	1.62	3.68	Black	23	1.67
YS38FXLTCKITC	500 kcmil H,I,K 550 kcmil G,H,I DLO 535 (1325/24)	300 mm ² Class 5	Standard	1.71	3.87	Pink	L99	1.77
YS34LTCKITC	500 kcmil Code	240 mm ² Class 2	Standard	1.56	3.51	Brown	20	1.60
YS34FXLTCKITC	350 kcmil G,H,I,K,M DLO 373 (925/24)	240 mm ² Class 2	Standard	1.56	3.51	Blue	19 or L80	1.60
YS31LTCKITC	350 kcmil Code	185 mm ² Class 2	Standard	1.39	3.10	Red	17	1.42
YS29FXLTCKITC	250 kcmil Flex 4/0 AWG G,H,I,K,M DLO (550/24)	—	Standard	1.36	2.98	Yellow	16	1.38
YS28LTCKITC	4/0 AWG Code	—	Standard	1.23	2.69	Purple	15	1.24
YS26LTCKITC	2/0 AWG Code	70 mm ²	Standard	1.16	2.62	Black	13	1.10
YS26FXLTCKITC	2/0 AWG G,H,I,K,M DLO (325/24)	70 mm ² Class 5	Standard	1.09	2.41	Black	13	1.10
YS25LTCKITC	1/0 AWG Code	—	Standard	1.04	2.37	Pink	12	1.00
YS25FXLTCKITC	1/0 AWG G,H,I,K,M DLO (275/24) 1/0 AWG	50 mm ² Class 5	Standard	1.04	2.18	Pink	12	1.00
YS2CLTCKITC	#2 AWG Code	35 mm ² Class 5	Standard	0.82	1.88	Brown	10	0.78
YS2CFXLTCKITC	#2 AWG G,H,I,K,M DLO (150/24)	35 mm ² Class 5	Standard	0.82	1.73	Brown	10	0.78
YS4CFXLTCKITC	#4 AWG G,H,I,K,M DLO (105/24) #4 AWG	—	Standard	0.74	1.69	Gray	8	0.71
YS6CFXLTCKITC	#6 AWG G,H,I,K,M DLO (61/24) #6 AWG	16 mm ² Class 5 or Class 2	Standard	0.73	1.60	Blue	7 or 24	0.70
YS8CFXLTCKITC	#8 AWG G,H,I,K,M DLO (37/24) #8 AWG, #6 SOL, #8 SOL	—	Standard	0.65	1.48	Red	49	0.62

* Clear Heatshrink – UL224 VW1 Listed – passes TELCORDIA GR-347-CORE Abrasion and Cut Test.
(Up to 750 kcmil Class B code cable. Contact factory for 750 flex cable applications.)
Note: All dimensions shown are for reference only.

TYPE YS-A



HYLINK™ Aluminum Splices

UL Listed 90° C, Up to 35 kV ♦

Type YS-A is a high conductivity aluminum tin-plated compression butt splice for use on all combinations of aluminum to aluminum, aluminum to copper, and copper to copper conductor combinations.

They are designed to accommodate conductors from #12 stranded through 1000 kcmil in standard and heavy duty applications. Prefilled with PENETROX™ oxide inhibiting compounds and assembled with color-coded end caps, the connectors provide a permanent trouble-free electrical splice with flexibility and low installed cost.

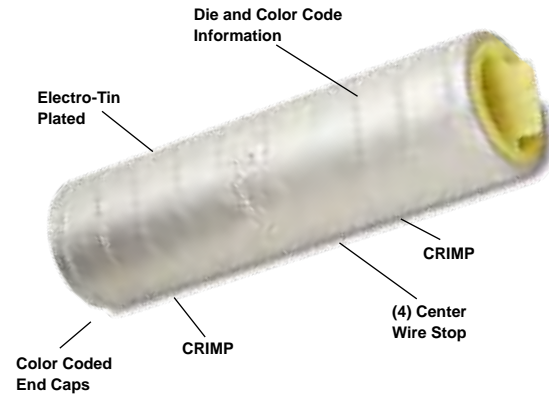

Features & Benefits

- Aluminum splices are dual rated to accommodate both copper and aluminum wire and are indicated with AL-CU on the connector:
 - AL9CU indicates the terminal can accommodate aluminum and copper wire and is UL Listed 90°C, up to 35kV
 - AL7CU indicates the terminal can accommodate aluminum and copper wire and is UL Listed 75°C, up to 35kV
- Barrel is designed with an internal chamfer at the wire entry to ensure smooth insertion of the wire, preventing possible damaging of the wire strands during insertion
- Electro-tin plated unless otherwise specified to reduce galvanic corrosion (bimetallic) and resist corrosive elements
- Connectors are clearly marked with wire size, die index, color code, and crimp location bands
- Factory pre-filled with PENETROX™ Type A13 oxide inhibitor
- Color coded end caps are factory inserted in the barrels to match the die color code and prevent foreign materials from entering the barrel
- Aluminum oxidation is not easily detected but causes resistance in a connection; it is imperative the proper preparation takes place prior to making an aluminum-to-aluminum connection
- BURNDY certifies its products using the BURNDY Engineered System and select other crimp tool manufacturers in accordance with one or more of the UL categories in order to obtain a UL Listing
- Conductor Accommodate Types:
 - Aluminum Code Wire: Class B (Concentric, Compressed, Compact)
 - Copper Code Wire: Class B (Concentric, Compressed, Compact or Class C)
 - Copper Clad Aluminum: Noted in the conductor accommodates as CCA

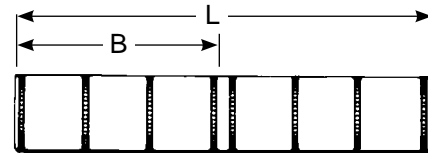

Accessories

- Hardware - Section F
- PENETROX™ Oxide Inhibitor - Section F
- Heat and Cold Shrink Tubing - Section D
- WIREMIKE™ Wire Micrometer - Section F
- Wire Management (Cable Ties) - Section G

TYPE YS-A (Continued)

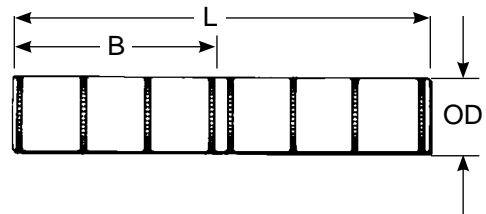

Catalog Number	Code • Conductor	Dimensions		Installation Tooling ▲					Wire Strip Length
				Dieless (# of crimps/end)		35 ■, 750, 46* Series		Die Index #	
				Mechanical	Hydraulic	Die Number (# of crimps per end)	Color Code		
YS12AG1	12 AWG	0.45	1.03	Ratchet: MR827 (1)	—	—	—	—	5/8
YS10WAG1	10 Sol.	0.50	1.12		—	—	—	—	5/8
YS8CA1	8 AWG	0.59	1.44	MY293 (1) MRC840AL (1)	644 Series (1) 81K Series (1)	U8CABT (1)	Blue	374	5/8
YS6CA1	6 AWG	0.72	1.70			U6CABT (1)	Gray	346	3/4
YS4CA1	4 AWG	0.86	1.97	MY293 (1) MRC840AL (2)	644 Series (1) 81K Series (2)	U4CABT (1)	Green	375	7/8
YS2CA1	2 AWG	1.09	2.44			U2CABT (1)	Pink	348	1-1/8
YS1CA1	1 AWG	0.90	2.05	MY293 (2) MRC840AL (3)	644 Series (1) 81K Series (2)	U1CART (1)	Gold	471	15/16
YS25A1	1/0 AWG	1.06	2.37			U25ART (1)	Tan	296	1-1/16
YS26A1	2/0 AWG	1.18	2.61			U26ART (2)	Olive	297	1-3/8
YS27A1	3/0 AWG	1.31	2.88			U27ART (2)	Ruby	467	1-1/2
YS28A1	4/0 AWG	1.40	3.06			U28ART (2)	White	298	1-5/8
YS29A1	250kcmil	1.46	3.18			U29ART (2)	Red	324	1-5/8
YS30A1	300 kcmil	1.47	3.20			U30ART (2)	Blue	470	1-3/4
YS31A1	350 kcmil	1.89	4.04			—	644 Series (1) 81K Series (2)	U31ART (2)	Brown
YS32A1	400kcmil	2.30	4.86	—	644 Series (1) 81K Series (4)	U32ART (2)	Green	472	2-1/2
YS34A1	500 kcmil	2.38	5.02			U34ART (2)	Pink	300	2-5/8
YS36A1	600 kcmil	2.44	5.14			U36ART (4)	Black	473	2-7/8
YS39A1	700 kcmil 750 kcmil +900 Compact Al	2.50	5.26			U39ART2 (4)	Yellow	936	2-7/8
YS39AM1	700 kcmil 750 kcmil +900 Compact Al	2.63	5.58	—	—	P39ART** (4)	Red	301	2-7/8
YS42A1	600 - 900 kcmil	2.50	5.26	—	644 Series (2)	U42ART (4)	Gray	303	2-7/8
YS44A1	1000 kcmil	2.84	5.94			P44ART** (4)	Brown	302	3
YS45A1^^	1250 kcmil	2.84	6.21			P48PR1/ L44ART** (6)	Brown	302	2-7/8
YS46A1^^	1500 kcmil	3.40	7.05			L46ART*** (2)	Blue	478	3-7/8
YS47A1^^	1750 kcmil	3.99	8.31			L47ART*** (2)	White	587	4
YS48A1^^	2000 kcmil	3.66	7.58			L48ART*** (2)	Red	479	3-5/8
YS483A1^^	2250 kcmil ALUMINUM ONLY	3.66	7.58			L48ART*** (2)	Red	479	3-5/8

▲ See tooling section of this catalog for complete tool and die listing.

‡ UL Listed for Aluminum only. Not CSA Certified.

+ Tested with Y644HSXT and PAT644XT-18V dieless tools only and not UL Listed with any tool on 900 Compact Al.

* Use PUADP1 adaptor with U dies in 46 Series.

■ The largest size for the 35 Series is 400 kcmil.

◆ For applications greater than 2000 Volts consult cable manufacturer for voltage stress relief instructions.

● Also accommodates compressed and compact conductors (except for 700 kcmil in 750 kcmil barrel).

^^ 75°C Rated

**P-RT dies for use in 46 Series tools only.

***L dies for use with 60 Ton HYPRESS™ only

Note: All dimensions shown are for reference only.

TYPE Y-R

Reducing Adapter for Copper

Up to 35 kV ♦

Type Y-R reducing adapter has been designed to allow large size, long barrel, copper HYDENT™, HYSPLICE™, and HYTEE™ terminals, splices and T-taps to be used on small conductor sizes. To use, simply insert the reducer into the barrel, insert the wire into the reducer adapter and crimp the outer barrel using its recommended tooling.

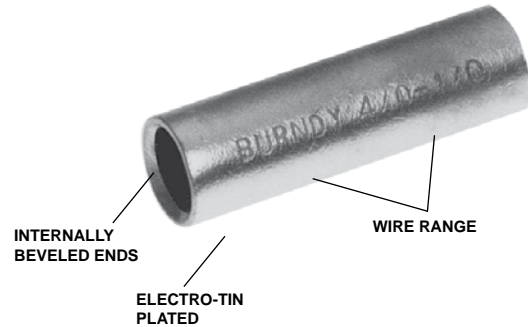

Features & Benefits

- Reducing adapters fit inside copper long barrel compression terminals (Type YA-), splices (Type YS-), or tap connectors
- The outside diameter of the reducing adapter is equivalent to the terminal or splice accommodating wire size, and the inside diameter of the reducer adapter is reduced to accommodate a smaller wire size
- Use the same installation tooling and die sets or dieless tool recommended for the compression terminal, splice, or tap connector with the reducing adapter
- Barrel is designed with an internal chamfer at the wire entry to ensure smooth insertion of the wire, preventing possible damage of the wire strands during insertion
- Electro-tin plated, unless otherwise specified, to reduce galvanic corrosion (bimetallic) and resist corrosive elements
- Can be field modified to fit short length compression terminals (Type YA-L) and splices (Type YS-L)
- Connectors are clearly marked with stamping
- Terminals and splices accommodating code wire: Accommodates Code Class B (Concentric, Compressed, Compact) and Class C wire

Catalog Number	Wire Range		Dimensions	
	From	To	Max O.D.	L
Y286CR	4/0 AWG	6,8 Str. 6 Sol.	0.53	1.75
Y284WR		4 Sol.	0.53	1.75
Y284CR		4 Str.	0.53	1.75
Y282CR		2 Str.	0.53	1.75
Y281CR		1 Str.	0.53	1.75
Y2825R		1/0 Str.	0.53	1.75
Y2826R		2/0 Str.	0.53	1.75
Y2827R		3/0 Str.	0.53	1.75
Y2928R	250 kcmil	4/0	0.58	1.62
Y304CR	300 kcmil	4	0.64	2.00
Y302CR		2	0.64	2.00
Y3025R		1/0	0.64	2.00
Y3026R		2/0	0.64	2.00
Y3027R		3/0	0.64	2.00
Y3028R		4/0	0.64	2.00
Y3126R		350 kcmil	2/0	0.69
Y3128R	4/0		0.69	2.00
Y3129R	250		0.69	2.00
Y342CR	500 kcmil	2 Str.	0.82	2.50
Y3425R		1/0 Str.	0.82	2.50
Y3426R		2/0 Str.	0.82	2.50
Y3427R		3/0 Str.	0.82	2.50
Y3428R		4/0 Str.	0.82	2.50
Y3429R		250 kcmil	0.82	2.50
Y3430R		300 kcmil	0.82	2.50
Y3431R		350 kcmil	0.82	2.50
Y3432R	400 kcmil	0.82	2.50	
Y3934R	750 kcmil	500 kcmil	1.02	2.88
Y3936R		600 kcmil	1.02	2.88
Y4439R	1000 kcmil	750 kcmil	1.30	3.00

Contact Technical Support for other sizes not listed.

♦ For applications greater than 2000 Volts consult cable manufacturer for voltage stress relief instructions.

Note: All dimensions shown are for reference only.



Example Accommodate a 4/0 AWG wire on one end and a #2 AWG wire on the other:

1. Use a YS28 (which splices two 4/0 AWG wires on each end)
2. Select a Y282CR reducing adapter (reducing adapter fits the YS28 barrel with a reduced inside diameter that accommodates a #2 AWG wire size)
3. Fully insert the Y282CR reducing adapter into one end of the YS28 splice barrel
4. Insert the #2 AWG wire into the Y282CR reducing adapter that is inside the YS28 splice barrel
5. Crimp the YS28 barrel side with the Y282CR reducing adapter, using the recommended die and tool combination or dieless tool as specified for use on the YS28
6. Insert the 4/0 AWG wire into the other end of the YS28 barrel and crimp that side of the splice using the recommended installation tooling and your splice reducing connection is complete!

TYPE YSR-TC

HYREDUCER™ In-Line Reducer Splice Kits Standard Barrel, with Inspection Window

Type YSR-TC reducing splice kits provide for splicing two different cable sizes with inspection holes. The larger conductor is inserted first and butts against the center of the connector where the smaller barrel begins. Constructed from seamless, high conductivity electrolytic copper tubing for maximum conductivity and tin plated to resist corrosion. The YSR-TC family also features the BURNDY® color code system.

Features & Benefits

- Each splice kit includes one YSR-TC compression in-line splice reducer connector and heat shrink
- The YSR-TC type reducing compression splice connector provided in the kit is UL Listed in accordance with UL 486A-486B - Wire Connectors; UL Listed 90°C up to 35kV
- Barrels have 2 inspection windows on each side to allow for visual verification that the wire has been fully inserted prior to crimping the splice
- Designed configurations allow for copper code-to-code wire connections, copper code-to-flex wire connections, and copper flex-to-flex wire connections; see table for more complete details
- Barrel is designed with a taper to accommodate a main run wire that is reduced to a smaller tap wire
- Barrel also provided with an internal chamfer at the wire entry to ensure smooth insertion of the wire, preventing possible damaging of the wire strands during insertion
- Electro-tin plated unless otherwise specified to reduce galvanic corrosion (bimetallic) and resist corrosive elements
- Short/standard length barrel is recommended for installations with limited space requirements and meet the exact UL testing requirements as long barrel connectors so performance of the connection is not compromised
- Connectors clearly marked with color coding
- Can be used in place of H-taps; the in-line design saves space in cable trays and other similar applications

Accessories

- Hardware - Section F
- PENETROX™ Oxide Inhibitor - Section F
- Heat and Cold Shrink Tubing - Section D
- WIREMIKE™ Wire Micrometer - Section F
- Wire Management (Cable Ties) - Section G

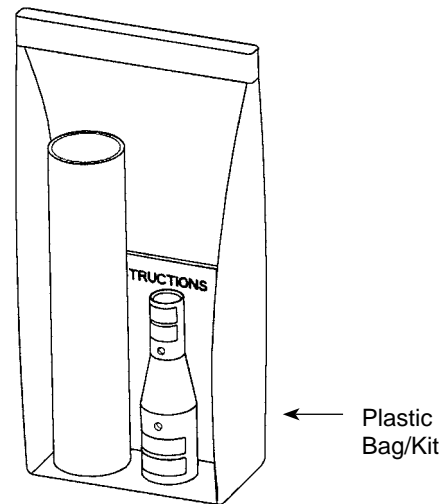

Connector with Clear Heat Shrink Kit
Clear heat shrink UL224 VW1 Listed. Passes TELCORDIA GR-347-CORE Abrasion and Cut Test up to 750 kcmil Class B code cable; contact factory for 750 flex cable applications.

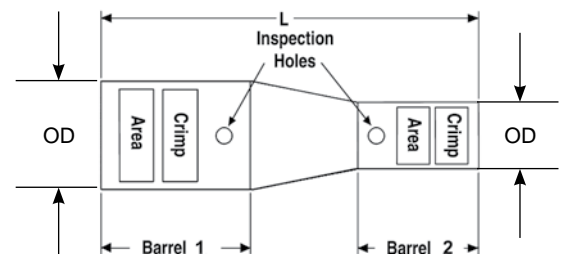

Compression Connections

Copper — Code / Flex — Reducing Splice Kit
Standard Barrel — with Inspection Window

TYPE YSR-TC (Continued)

HYREDUCER™ In-Line Standard Barrel Reducer
Splice Kits with Inspection Window

Connector with Clear Heat Shrink Kit

Clear heat shrink UL224 VW1 Listed. Passes TELCORDIA GR-347-CORE
Abrasion and Cut Test up to 750 kcmil Class B code cable; contact factory for
750 flex cable applications.

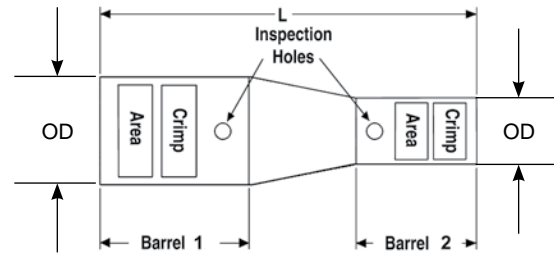

Kit Catalog Number	Overall Length (L)	Barrel 1					Barrel 2				
		Copper Wire Size		Dimensions		Color Code & Die Index #	Copper Wire Size		Dimensions		Color Code & Die Index #
		Conductor	MM ²	Outside Diameter (OD)	Barrel Length (B)		Conductor	MM ²	Outside Diameter (OD)	Barrel Length (B)	
YSR44FX39LTCKITC	4.38	750 KCMIL G,H 777 DLO	500 MM ² Class 5	1.49	2.09	Yellow L115	750 KCMIL B,C	-	1.30	1.78	Black 24
YSR44FX38FXLTCKITC	4.61	750 KCMIL G,H 777 DLO	500 MM ² Class 5	1.49	2.09	Yellow L115	500 KCMIL H,I,K 550 KCMIL G,H,I 535 DLO	300 MM ² Class 5	1.25	1.60	Pink L99
YSR44FX34LTCKITC	4.91	750 KCMIL G,H 777 DLO	500 MM ² Class 5	1.49	2.09	Yellow L115	500 KCMIL B,C	240 MM ² Class 2	1.06	1.69	Brown 20
YSR44FX34FXLTCKITC	4.91	750 KCMIL G,H 777 DLO	500 MM ² Class 5	1.49	2.09	Yellow L115	350 KCMIL G,H,I,K,M 373 DLO	240 MM ² Class 5	1.06	1.69	Blue 19
YSR44FX31LTCKITC	5.18	750 KCMIL G,H 777 DLO	500 MM ² Class 5	1.49	2.09	Yellow L115	350 KCMIL B,C	185 MM ² Class 2	0.88	1.49	Red 18
YSR44FX30LTCKITC	5.01	750 KCMIL G,H 777 DLO	500 MM ² Class 5	1.49	2.09	Yellow L115	300 KCMIL B,C	150 MM ² Class 2	0.81	1.30	White 17
YSR44FX29LTCKITC	5.53	750 KCMIL G,H 777 DLO	500 MM ² Class 5	1.49	2.09	Yellow L115	250 KCMIL B,C	-	0.75	1.44	Yellow 16
YSR44FX29FXLTCKITC	5.33	750 KCMIL G,H 777 DLO	500 MM ² Class 5	1.49	2.09	Yellow L115	250 KCMIL B,C 4/0 AWG G,H,I,K,M DLO	120 MM ² Class 5	0.86	1.44	Yellow 16
YSR44FX28LTCKITC	5.27	750 KCMIL G,H 777 DLO	500 MM ² Class 5	1.49	2.09	Yellow L115	4/0 AWG B,C	-	0.69	1.30	Purple 15
YSR44FX28FXLTCKITC	5.46	750 KCMIL G,H 777 DLO	500 MM ² Class 5	1.49	2.09	Yellow L115	4/0 AWG B,C,G,H,I,K,M DLO	120 MM ² Class 5	0.77	1.40	Purple 15
YSR3939LTCKITC	4.13	750 KCMIL B,C	-	1.30	1.78	Black 24	750 KCMIL B,C	-	1.30	1.78	Black 24
YSR3938FXLTCKITC	3.79	750 KCMIL B,C	-	1.30	1.78	Black 24	500 KCMIL H,I,K 550 KCMIL G,H,I 535 DLO	300 MM ² Class 5	1.25	1.88	Pink L99
YSR3934LTCKITC	4.09	750 KCMIL B,C	-	1.30	1.78	Black 24	500 KCMIL B,C	240 MM ² Class 2	1.06	1.69	Brown 20

Separate Installation Tooling Chart follows.

TYPE YSR-TC (Continued)

HYREDUCER™ In-Line Standard Barrel Reducer
Splice Kits with Inspection Window

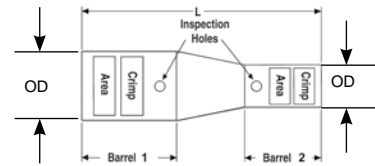

Kit Catalog Number	Overall Length (L)	Barrel 1					Barrel 2				
		Copper Wire Size		Dimensions		Color Code & Die Index #	Copper Wire Size		Dimensions		Color Code & Die Index #
		Conductor	MM ²	Outside Diameter (OD)	Barrel Length (B)		Conductor	MM ²	Outside Diameter (OD)	Barrel Length (B)	
YSR3934FXLTCKITC	4.09	750 KCMIL B,C	-	1.30	1.78	Black 24	250 KCMIL G,H,I,K,M 373 DLO	240 MM ² Class 5	1.06	1.69	Blue 19
YSR3931LTCKITC	4.36	750 KCMIL B,C	-	1.30	1.78	Black 24	350 KCMIL B,C	185 MM ² Class 2	0.88	1.49	Red 18
YSR3930LTCKITC	4.23	750 KCMIL B,C	-	1.30	1.78	Black 24	300 KCMIL B,C	150 MM ² Class 2	0.81	1.30	White 17
YSR3929LTCKITC	4.71	750 KCMIL B,C	-	1.30	1.78	Black 24	250 KCMIL B,C	-	0.75	1.44	Yellow 16
YSR3929FXLTCKITC	4.59	750 KCMIL B,C	-	1.30	1.78	Black 24	250 KCMIL B,C 4/0 AWG G,H,I,K,M DLO	120 MM ² Class 5	0.86	1.44	Yellow 16
YSR3928LTCKITC	4.65	750 KCMIL B,C	-	1.30	1.78	Black 24	4/0 AWG B,C	-	0.69	1.30	Purple 15
YSR3928FXLTCKITC	4.64	750 KCMIL B,C	-	1.30	1.78	Black 24	4/0 AWG B,C,G,H,I,K,M DLO	120 MM ² Class 5	0.77	1.40	Purple 15
YSR38FX34LTCKITC	4.06	500 KCMIL H,I,K 550 KCMIL G,H,I 535 DLO	300 MM ² Class 5	1.25	1.88	Pink L99	500 KCMIL B,C	240 MM ² Class 2	1.06	1.69	Brown 20
YSR38FX34FXLTCKITC	4.06	500 KCMIL H,I,K 550 KCMIL G,H,I 535 DLO	300 MM ² Class 5	1.25	1.88	Pink L99	350 KCMIL G,H,I,K,M 373 DLO	240 MM ² Class 5	1.06	1.69	Blue 19
YSR38FX31LTCKITC	4.33	500 KCMIL H,I,K 550 KCMIL G,H,I 535 DLO	300 MM ² Class 5	1.25	1.88	Pink L99	350 KCMIL B,C	185 MM ² Class 2	0.88	1.49	Red 18
YSR38FX30LTCKITC	4.20	500 KCMIL H,I,K 550 KCMIL G,H,I 535 DLO	300 MM ² Class 5	1.25	1.88	Pink L99	300 KCMIL B,C	150 MM ² Class 2	0.81	1.30	White 17
YSR38FX29LTCKITC	4.67	500 KCMIL H,I,K 550 KCMIL G,H,I 535 DLO	300 MM ² Class 5	1.25	1.88	Pink L99	250 KCMIL B,C	-	0.75	1.44	Yellow 16
YSR38FX29FXLTCKITC	4.48	500 KCMIL H,I,K 550 KCMIL G,H,I 535 DLO	300 MM ² Class 5	1.25	1.88	Pink L99	250 KCMIL B,C 4/0 AWG G,H,I,K,M DLO	120 MM ² Class 5	0.86	1.44	Yellow 16

Separate Installation Tooling Chart follows.

Compression Connections

Copper — Code / Flex — Reducing Splice Kit
Standard Barrel — with Inspection Window

TYPE YSR-TC (Continued)

HYREDUCER™ In-Line Standard Barrel Reducer
Splice Kits with Inspection Window

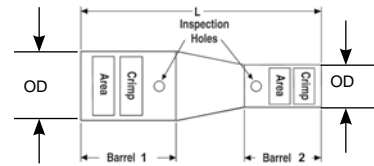

Kit Catalog Number	Overall Length (L)	Barrel 1					Barrel 2				
		Copper Wire Size		Dimensions		Color Code & Die Index #	Copper Wire Size		Dimensions		Color Code & Die Index #
		Conductor	MM ²	Outside Diameter (OD)	Barrel Length (B)		Conductor	MM ²	Outside Diameter (OD)	Barrel Length (B)	
YSR38FX28FXLTCKITC	4.60	500 KCMIL H,I,K 550 KCMIL G,H,I 535 DLO	300 MM ² Class 5	1.25	1.88	Pink L99	4/0 AWG B,C,G,H,I,K,M DLO	120 MM ² Class 5	0.77	1.40	Purple 15
YSR38FX28LTCKITC	4.62	500 KCMIL H,I,K 550 KCMIL G,H,I 535 DLO	300 MM ² Class 5	1.25	1.88	Pink L99	4/0 AWG B,C	-	0.69	1.30	Purple 15
YSR38FX26FXLTCKITC	4.62	500 KCMIL H,I,K 550 KCMIL G,H,I 535 DLO	300 MM ² Class 5	1.25	1.88	Pink L99	2/0 AWG B,C,G,H,I,K,M DLO	70 MM ² Class 5	0.63	1.13	Black 13
YSR3434FXLTCKITC	3.51	500 KCMIL B,C	240 MM ² Class 2	1.06	1.69	Brown 20	350 KCMIL G,H,I,K,M 373 DLO	240 MM ² Class 5	1.06	1.69	Blue 19
YSR3431LTCKITC	3.66	500 KCMIL B,C	240 MM ² Class 2	1.06	1.69	Brown 20	350 KCMIL B,C	185 MM ² Class 2	0.88	1.49	Red 18
YSR3429FXLTCKITC	3.81	500 KCMIL B,C	240 MM ² Class 2	1.06	1.69	Brown 20	250 KCMIL B,C 4/0 AWG G,H,I,K,M DLO	120 MM ² Class 5	0.86	1.44	Yellow 16
YSR3428LTCKITC	3.95	500 KCMIL B,C	240 MM ² Class 2	1.06	1.69	Brown 20	4/0 AWG B,C	-	0.69	1.30	Purple 15
YSR3426FXLTCKITC	4.01	500 KCMIL B,C	240 MM ² Class 2	1.06	1.69	Brown 20	2/0 AWG B,C,G,H,I,K,M DLO	70 MM ² Class 5	0.63	1.13	Black 13
YSR3425FXLTCKITC	4.01	500 KCMIL B,C	240 MM ² Class 2	1.06	1.69	Brown 20	1/0 AWG B,C,G,H,I,K,M DLO	50 MM ² Class 5	0.56	1.04	Pink 12
YSR34FX31LTCKITC	3.63	350 KCMIL G,H,I,K,M 373 DLO	240 MM ² Class 5	1.06	1.69	Blue 19	350 KCMIL B,C	185 MM ² Class 2	0.88	1.49	Red 18
YSR34FX29FXLTCKITC	3.81	350 KCMIL G,H,I,K,M 373 DLO	240 MM ² Class 5	1.06	1.69	Blue 19	250 KCMIL B,C 4/0 AWG G,H,I,K,M DLO	120 MM ² Class 5	0.86	1.44	Yellow 16
YSR34FX28FXLTCKITC	3.86	350 KCMIL G,H,I,K,M 373 DLO	240 MM ² Class 5	1.06	1.69	Blue 19	4/0 AWG B,C,G,H,I,K,M DLO	120 MM ² Class 5	0.77	1.43	Purple 15
YSR34FX28LTCKITC	3.95	350 KCMIL G,H,I,K,M 373 DLO	240 MM ² Class 5	1.06	1.69	Blue 19	4/0 AWG B,C	-	0.69	1.3	Purple 15
YSR34FX26FXLTCKITC	3.94	350 KCMIL G,H,I,K,M 373 DLO	240 MM ² Class 5	1.06	1.69	Blue 19	2/0 AWG B,C,G,H,I,K,M DLO	70 MM ² Class 5	0.63	1.13	Black 13

Separate Installation Tooling Chart follows.

TYPE YSR-TC (Continued)

HYREDUCER™ In-Line Standard Barrel Reducer
Splice Kits with Inspection Window

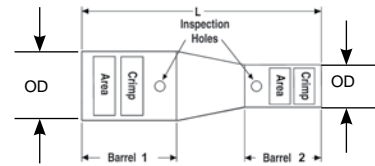

Kit Catalog Number	Overall Length (L)	Barrel 1					Barrel 2				
		Copper Wire Size		Dimensions		Color Code & Die Index #	Copper Wire Size		Dimensions		Color Code & Die Index #
		Conductor	MM ²	Outside Diameter (OD)	Barrel Length (B)		Conductor	MM ²	Outside Diameter (OD)	Barrel Length (B)	
YSR34FX25FXLTCKITC	4.01	350 KCMIL G,H,I,K,M 373 DLO	240 MM ² Class 5	1.06	1.69	Blue 19	1/0 AWG B,C,G,H,I,K,M DLO	50 MM ² Class 5	0.56	1.04	Pink 12
YSR34FX2CFXLTCKITC	4.02	350 KCMIL G,H,I,K,M 373 DLO	240 MM ² Class 5	1.06	1.69	Blue 19	#2 AWG B,C,G,H,I,K,M DLO	35 MM ² Class 5	0.46	0.82	Brown 10
YSR34FX4CFXLTCKITC	4.11	350 KCMIL G,H,I,K,M 373 DLO	240 MM ² Class 5	1.06	1.69	Blue 19	#4 AWG B,C,G,H,I,K,M DLO	-	0.38	0.74	Gray 8
YSR34FX6CFXLTCKITC	4.26	350 KCMIL G,H,I,K,M 373 DLO	240 MM ² Class 5	1.06	1.69	Blue 19	#6 AWG B,C,G,H,I,K,M DLO	16 MM ² Class 5	0.31	0.73	Blue 7
YSR3129FXLTCKITC	3.13	350 KCMIL B,C	185 MM ² Class 2	0.88	1.49	Red 18	250 KCMIL B,C 4/0 AWG G,H,I,K,M DLO	120 MM ² Class 5	0.86	1.44	Yellow 16
YSR3128FXLTCKITC	3.25	350 KCMIL B,C	185 MM ² Class 2	0.88	1.25	Red 18	4/0 AWG B,C,G,H,I,K,M DLO	120 MM ² Class 5	0.77	1.40	Purple 15
YSR3128LTCKITC	3.27	350 KCMIL B,C	185 MM ² Class 2	0.88	1.49	Red 18	4/0 AWG B,C	-	0.69	1.30	Purple 15
YSR3126FXLTCKITC	3.24	350 KCMIL B,C	185 MM ² Class 2	0.88	1.49	Red 18	2/0 AWG B,C,G,H,I,K,M DLO	70 MM ² Class 5	0.63	1.16	Black 13
YSR3125FXLTCKITC	3.33	350 KCMIL B,C	185 MM ² Class 2	0.88	1.49	Red 18	1/0 AWG B,C,G,H,I,K,M DLO	50 MM ² Class 5	0.56	1.04	Pink 12
YSR312CFXLTCKITC	3.37	350 KCMIL B,C	185 MM ² Class 2	0.88	1.49	Red 18	#2 AWG B,C,G,H,I,K,M DLO	35 MM ² Class 5	0.46	0.82	Brown 10
YSR314CFXLTCKITC	3.43	350 KCMIL B,C	185 MM ² Class 2	0.88	1.49	Red 18	#4 AWG B,C,G,H,I,K,M DLO	-	0.38	0.74	Gray 8
YSR316CFXLTCKITC	3.58	350 KCMIL B,C	185 MM ² Class 2	0.88	1.49	Red 18	#6 AWG B,C,G,H,I,K,M DLO	16 MM ² Class 5	0.31	0.73	Blue 7
YSR32FX29FXLTCKITC	3.50	300 KCMIL G,H,I,K,M DLO	185 MM ² Class 5	0.95	1.57	Red 18	250 KCMIL B,C 4/0 AWG G,H,I,K,M DLO	120 MM ² Class 5	0.86	1.44	Yellow 16
YSR32FX28FXLTCKITC	3.46	300 KCMIL G,H,I,K,M DLO	185 MM ² Class 5	0.95	1.57	Red 18	4/0 AWG B,C,G,H,I,K,M DLO	120 MM ² Class 5	0.77	1.43	Purple 15
YSR29FX28LTCKITC	3.00	250 KCMIL B,C 4/0 AWG G,H,I,K,M DLO	120 MM ² Class 5	0.86	1.44	Yellow 16	4/0 AWG B,C	-	0.69	1.30	Purple 15

Separate Installation Tooling Chart follows.

Compression Connections

Copper — Code / Flex — Reducing Splice Kit
Standard Barrel — with Inspection Window

TYPE YSR-TC (Continued)

HYREDUCER™ In-Line Standard Barrel Reducer
Splice Kits with Inspection Window

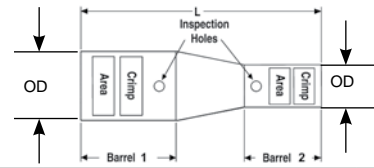

Kit Catalog Number	Overall Length (L)	Barrel 1					Barrel 2				
		Copper Wire Size		Dimensions		Color Code & Die Index #	Copper Wire Size		Dimensions		Color Code & Die Index #
		Conductor	MM ²	Outside Diameter (OD)	Barrel Length (B)		Conductor	MM ²	Outside Diameter (OD)	Barrel Length (B)	
YSR29FX25FXLTCKITC	3.10	250 KCMIL B,C 4/0 AWG G,H,I,K,M DLO	120 MM ² Class 5	0.86	1.44	Yellow 16	1/0 AWG B,C,G,H,I,K,M DLO	50 MM ² Class 5	0.56	1.04	Pink 12
YSR29FX2CFXLTCKITC	3.13	250 KCMIL B,C 4/0 AWG G,H,I,K,M DLO	120 MM ² Class 5	0.86	1.44	Yellow 16	#2 AWG B,C,G,H,I,K,M DLO	35 MM ² Class 5	0.46	0.82	Brown 10
YSR2825FXLTCKITC	2.66	4/0 AWG B,C	-	0.69	1.30	Purple 15	1/0 AWG B,C,G,H,I,K,M DLO	50 MM ² Class 5	0.56	1.04	Pink 12
YSR282CFXLTCKITC	2.70	4/0 AWG B,C	-	0.69	1.30	Purple 15	#2 AWG B,C,G,H,I,K,M DLO	35 MM ² Class 5	0.46	0.82	Brown 10
YSR284CFXLTCKITC	2.69	4/0 AWG B,C	-	0.69	1.30	Purple 15	#4 AWG B,C,G,H,I,K,M DLO	-	0.38	0.74	Gray 8
YSR286CFXLTCKITC	2.99	4/0 AWG B,C	-	0.69	1.30	Purple 15	#6 AWG B,C,G,H,I,K,M DLO	16 MM ² Class 5	0.31	0.73	Blue 7
YSR28FX28LTCKITC	3.00	4/0 AWG B,C,G,H,I,K,M DLO	120 MM ² Class 5	0.77	1.43	Purple 15	4/0 AWG B,C	-	0.69	1.27	Purple 15
YSR28FX26FXLTCKITC	2.94	4/0 AWG B,C,G,H,I,K,M DLO	120 MM ² Class 5	0.77	1.43	Purple 15	2/0 AWG B,C,G,H,I,K,M DLO	70 MM ² Class 5	0.63	1.13	Black 13
YSR28FX25FXLTCKITC	3.07	4/0 AWG B,C,G,H,I,K,M DLO	120 MM ² Class 5	0.77	1.43	Purple 15	1/0 AWG B,C,G,H,I,K,M DLO	50 MM ² Class 5	0.56	1.02	Pink 12
YSR28FX2CFXLTCKITC	3.11	4/0 AWG B,C,G,H,I,K,M DLO	120 MM ² Class 5	0.77	1.43	Purple 15	#2 AWG B,C,G,H,I,K,M DLO	35 MM ² Class 5	0.46	0.79	Brown 10
YSR28FX4CFXLTCKITC	3.10	4/0 AWG B,C,G,H,I,K,M DLO	120 MM ² Class 5	0.77	1.43	Purple 15	#4 AWG B,C,G,H,I,K,M DLO	-	0.38	0.74	Gray 8
YSR26FX25FXLTCKITC	2.36	2/0 AWG B,C,G,H,I,K,M DLO	70 MM ² Class 5	0.63	1.16	Black 13	1/0 AWG B,C,G,H,I,K,M DLO	50 MM ² Class 5	0.56	1.04	Pink 12
YSR26FX2CFXLTCKITC	2.41	2/0 AWG B,C,G,H,I,K,M DLO	70 MM ² Class 5	0.63	1.16	Black 13	#2 AWG B,C,G,H,I,K,M DLO	35 MM ² Class 5	0.46	0.82	Brown 10
YSR26FX4CFXLTCKITC	2.47	2/0 AWG B,C,G,H,I,K,M DLO	70 MM ² Class 5	0.63	1.16	Black 13	#4 AWG B,C,G,H,I,K,M DLO	-	0.38	0.74	Gray 8
YSR26FX6CFXLTCKITC	2.71	2/0 AWG B,C,G,H,I,K,M DLO	70 MM ² Class 5	0.63	1.16	Black 13	#6 AWG B,C,G,H,I,K,M DLO	16 MM ² Class 5	0.31	0.73	Blue 7

Separate Installation Tooling Chart follows.

TYPE YSR-TC (Continued)

HYREDUCER™ In-Line Standard Barrel Reducer
Splice Kits with Inspection Window

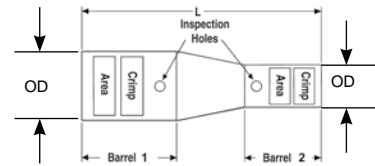

Kit Catalog Number	Overall Length (L)	Barrel 1					Barrel 2				
		Copper Wire Size		Dimensions		Color Code & Die Index #	Copper Wire Size		Dimensions		Color Code & Die Index #
		Conductor	MM ²	Outside Diameter (OD)	Barrel Length (B)		Conductor	MM ²	Outside Diameter (OD)	Barrel Length (B)	
YSR25FX2CFXLTKITC	2.12	1/0 AWG B,C,G,H,I,K,M DLO	50 MM ² Class 5	0.56	1.04	Pink 12	#2 AWG B,C,G,H,I,K,M DLO	35 MM ² Class 5	0.46	0.82	Brown 10
YSR25FX4CFXLTKITC	2.18	1/0 AWG B,C,G,H,I,K,M DLO	50 MM ² Class 5	0.56	1.04	Pink 12	#4 AWG B,C,G,H,I,K,M DLO	-	0.38	0.74	Gray 8
YSR25FX6CFXLTKITC	2.42	1/0 AWG B,C,G,H,I,K,M DLO	50 MM ² Class 5	0.56	1.04	Pink 12	#6 AWG B,C,G,H,I,K,M DLO	16 MM ² Class 5	0.31	0.63	Blue 7
YSR25FX8CFXLTKITC	2.31	1/0 AWG B,C,G,H,I,K,M DLO	50 MM ² Class 5	0.56	1.04	Pink 12	#8 AWG B,C,G,H,I,K,M DLO #8 SOL #6 SOL	10 MM ² Class 5	0.27	0.73	Red 49
YSR2CFX4CFXLTKITC	1.79	#2 AWG B,C,G,H,I,K,M DLO	35 MM ² Class 5	0.46	0.82	Brown 10	#4 AWG B,C,G,H,I,K,M DLO	-	0.38	0.74	Gray 8
YSR2CFX6CFXLTKITC	1.96	#2 AWG B,C,G,H,I,K,M DLO	35 MM ² Class 5	0.46	0.82	Brown 10	#6 AWG B,C,G,H,I,K,M DLO	16 MM ² Class 5	0.31	0.73	Blue 7
YSR2CFX8CFXLTKITC	1.79	#2 AWG B,C,G,H,I,K,M DLO	35 MM ² Class 5	0.46	0.82	Brown 10	#8 AWG B,C,G,H,I,K,M DLO #8 SOL #6 SOL	10 MM ² Class 5	0.27	0.60	Red 49
YSR4CFX6CFXLTKITC	1.67	#4 AWG B,C,G,H,I,K,M DLO	-	0.38	0.74	Gray 8	#6 AWG B,C,G,H,I,K,M DLO	16 MM ² Class 5	0.31	0.73	Blue 7
YSR4CFX8CFXLTKITC	1.50	#4 AWG B,C,G,H,I,K,M DLO	-	0.38	0.74	Gray 8	#8 AWG B,C,G,H,I,K,M DLO #8 SOL #6 SOL	10 MM ² Class 5	0.27	0.60	Red 49
YSR4CFX10CLTKITC	1.66	#4 AWG B,C,G,H,I,K,M DLO	-	0.38	0.74	Gray 8	#14 - #10 AWG I,K,M DLO	6 MM ² Class 2 2.5 MM ² Class 5	0.21	0.66	-
YSR6CFX8CFXLTKITC	1.37	#6 AWG B,C,G,H,I,K,M DLO	16 MM ² Class 5	0.31	0.73	Blue 7	#8 AWG B,C,G,H,I,K,M DLO #8 SOL #6 SOL	10 MM ² Class 5	0.27	0.60	Red 49
YSR6CFX10CLTKITC	1.53	#6 AWG B,C,G,H,I,K,M DLO	16 MM ² Class 5	0.31	0.73	Blue 7	#14 - #10 AWG I,K,M DLO	6 MM ² Class 2 2.5 MM ² Class 5	0.21	0.66	-
YSR6CFX14CLTKITC	1.53	#6 AWG B,C,G,H,I,K,M DLO	16 MM ² Class 5	0.31	0.73	Blue 7	#14 - #10 AWG I,K,M DLO	6 MM ² Class 2 2.5 MM ² Class 5	0.21	0.66	-

Separate Installation Tooling Chart follows.

Compression Connections

Copper — Code / Flex — Reducing Splice Kit
Standard Barrel — with Inspection Window

TYPE YSR-TC (Continued)

HYREDUCER™ In-Line Standard Barrel Reducer
Splice Kits with Inspection Window

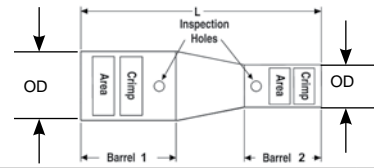

Kit Catalog Number	Overall Length (L)	Barrel 1					Barrel 2				
		Copper Wire Size		Dimensions		Color Code & Die Index #	Copper Wire Size		Dimensions		Color Code & Die Index #
		Conductor	MM ²	Outside Diameter (OD)	Barrel Length (B)		Conductor	MM ²	Outside Diameter (OD)	Barrel Length (B)	
YSR8CFX10CLTCKITC	1.41	#8 AWG B,C,G,H,I,K,M DLO #8 SOL #6 SOL	10 MM ² Class 5	0.27	0.57	Red 49	#14 - #10 AWG I,K,M DLO	6 MM ² Class 2 2.5 MM ² Class 5	0.00	0.66	-
YSR8CFX14CLTCKITC	1.41	#8 AWG B,C,G,H,I,K,M DLO #8 SOL #6 SOL	10 MM ² Class 5	0.27	0.57	Red 49	#14 - #10 AWG I,K,M DLO	6 MM ² Class 2 2.5 MM ² Class 5	0.21	0.66	-
YSR10CFX12CLTCKITC	1.45	#14 - #10 AWG I,K,M DLO	6 MM ² Class 2 2.5 MM ² Class 5	0.21	0.66	-	#14 - #10 AWG I,K,M DLO #12 AWG SOL #10 AWG SOL	6 MM ² Class 2 2.5 MM ² Class 5	0.21	0.66	-
YSR10CFX14CLTCKITC	1.45	#14 - #10 AWG I,K,M DLO	6 MM ² Class 2 2.5 MM ² Class 5	0.21	0.66	-	#14 - #10 AWG I,K,M DLO	6 MM ² Class 2 2.5 MM ² Class 5	0.21	0.66	-

Separate Installation Tooling Chart follows.

TYPE YSR-TC (Continued)

HYDRAULIC INSTALLATION TOOLING CHART Standard Barrel with Inspection Window

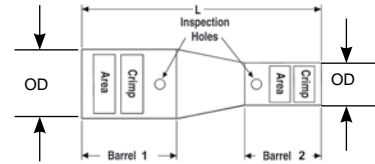

Kit Catalog Number	Barrel	Strip Length	Color Code & Die Index #	Hydraulic Tools Dies Required (# of Crimps)					Hydraulic Dieless Tools Number of Crimps	
				PATMD / 600 / 500 Series	750 / 35 Series	45 Series Use PT6515 with U Dies	46 Series Use PUADP1 with U Dies	60 Series	81K / 81K2 / 4PC Series	644 / 444S Series
YSR44FX39LTCKITC	1	1.96	Yellow L115	-	U44XRT (2)	U44XRT (2)	U44XRT (2) P44XRT (2)	L44RT (2)	2 OVERLAPPING CRIMPS	1 CRIMP
	2	1.67	Black 24	-	U39RT (2)	U39RT (2)	U39RT (2) P39RT (2)	L39RT (1)	3 OVERLAPPING CRIMPS	1 CRIMP
YSR44FX38FLTCKITC	1	1.96	Yellow L115	-	U44XRT (2)	U44XRT (2)	U44XRT (2) P44XRT (2)	L44RT (2)	2 OVERLAPPING CRIMPS	1 CRIMP
	2	1.77	Pink L99	-	U38XRT (2)	U38XRT (2)	U38XRT (2)	L38RT (1)	1 CRIMP	1 CRIMP
YSR44FX34LTCKITC	1	1.96	Yellow L115	-	U44XRT (2)	U44XRT (2)	U44XRT (2) P44XRT (2)	L44RT (2)	2 OVERLAPPING CRIMPS	1 CRIMP
	2	1.60	Brown 20	W34RT (2) W34VT (2)	U34RT (2)	U34RT (2)	U34RT (2)	L34RT (1)	2 OVERLAPPING CRIMPS	1 CRIMP
YSR44FX34FLTCKITC	1	1.96	Yellow L115	-	U44XRT (2)	U44XRT (2)	U44XRT (2) P44XRT (2)	L44RT (2)	2 OVERLAPPING CRIMPS	1 CRIMP
	2	1.60	Blue 19	W32RT (2) W32VT (2)	U32RT (2)	U32RT (2)	U32RT (2)	L34RT (1)	1 CRIMP	1 CRIMP
YSR44FX31LTCKITC	1	1.96	Yellow L115	-	U44XRT (2)	U44XRT (2)	U44XRT (2) P44XRT (2)	L44RT (2)	2 OVERLAPPING CRIMPS	1 CRIMP
	2	1.41	Red 18	W31RT (2) W31VT (2)	U31RT (2)	U31RT (2)	U31RT (2)	L31RT (1)	2 OVERLAPPING CRIMPS	1 CRIMP
YSR44FX30LTCKITC	1	1.96	Yellow L115	-	U44XRT (2)	U44XRT (2)	U44XRT (2) P44XRT (2)	L44RT (2)	2 OVERLAPPING CRIMPS	1 CRIMP
	2	1.24	White 17	W30RT (2) W30VT (2)	U30RT (2)	U30RT (2)	U30RT (2)	L30RT (1)	2 OVERLAPPING CRIMPS	1 CRIMP
YSR44FX29LTCKITC	1	1.96	Yellow L115	-	U44XRT (2)	U44XRT (2)	U44XRT (2) P44XRT (2)	L44RT (2)	2 OVERLAPPING CRIMPS	1 CRIMP
	2	1.38	Yellow 16	X29RT (4) W29RT (2) W29VT (2)	U29RT (1)	U29RT (1)	U29RT (1)	L29RT (1)	2 OVERLAPPING CRIMPS	1 CRIMP
YSR44FX29FLTCKITC	1	1.96	Yellow L115	-	U44XRT (2)	U44XRT (2)	U44XRT (2) P44XRT (2)	L44RT (2)	2 OVERLAPPING CRIMPS	1 CRIMP
	2	1.38	Yellow 16	X29RT (4) W29RT (2) W29VT (2)	U29RT (1)	U29RT (1)	U29RT (1)	L29RT (1)	1 CRIMP	1 CRIMP
YSR44FX28LTCKITC	1	1.96	Yellow L115	-	U44XRT (2)	U44XRT (2)	U44XRT (2) P44XRT (2)	L44RT (2)	2 OVERLAPPING CRIMPS	1 CRIMP
	2	1.24	Purple 15	X28RT (3) W28RT (2) W28VT (2)	U28RT (1)	U28RT (1)	U28RT (1)	L28RT (1)	2 OVERLAPPING CRIMPS	1 CRIMP
YSR44FX28FLTCKITC	1	1.96	Yellow L115	-	U44XRT (2)	U44XRT (2)	U44XRT (2) P44XRT (2)	L44RT (2)	2 OVERLAPPING CRIMPS	1 CRIMP
	2	1.36	Purple 15	X28RT (3) W28RT (2) W28VT (2)	U28RT (1)	U28RT (1)	U28RT (1)	L28RT (1)	1 CRIMP	1 CRIMP

TYPE YSR-TC (Continued)

HYDRAULIC INSTALLATION TOOLING CHART

Standard Barrel with Inspection Window

Kit Catalog Number	Barrel	Strip Length	Color Code & Die Index #	Hydraulic Tools Dies Required (# of Crimps)					Hydraulic Dieless Tools Number of Crimps	
				PATMD / 600 / 500 Series	750 / 35 Series	45 Series Use PT6515 with U Dies	46 Series Use PUADP1 with U Dies	60 Series	81K / 81K2 / 4PC Series	644 / 444S Series
YSR3939LTCKITC	1	1.67	Black 24	-	U39RT (2)	U39RT (2)	U39RT (2) P39RT (2)	L39RT (1)	3 OVERLAPPING CRIMPS	1 CRIMP
	2	1.67	Black 24	-	U39RT (2)	U39RT (2)	U39RT (2) P39RT (2)	L39RT (1)	3 OVERLAPPING CRIMPS	1 CRIMP
YSR3938FXLTCKITC	1	1.67	Black 24	-	U39RT (2)	U39RT (2)	U39RT (2) P39RT (2)	L39RT (1)	3 OVERLAPPING CRIMPS	1 CRIMP
	2	1.77	Pink L99	-	U38XRT (2)	U38XRT (2)	U38XRT (2)	L38RT (1)	1 CRIMP	1 CRIMP
YSR3934LTCKITC	1	1.67	Black 24	-	U39RT (2)	U39RT (2)	U39RT (2) P39RT (2)	L39RT (1)	3 OVERLAPPING CRIMPS	1 CRIMP
	2	1.60	Brown 20	W34RT (2) W34VT (2)	U34RT (2)	U34RT (2)	U34RT (2)	L34RT (1)	2 OVERLAPPING CRIMPS	1 CRIMP
YSR3934FXLTCKITC	1	1.67	Black 24	-	U39RT (2)	U39RT (2)	U39RT (2) P39RT (2)	L39RT (1)	3 OVERLAPPING CRIMPS	1 CRIMP
	2	1.60	Blue 19	W32RT (2) W32VT (2)	U32RT (2)	U32RT (2)	U32RT (2)	L34RT (1)	1 CRIMP	1 CRIMP
YSR3931LTCKITC	1	1.67	Black 24	-	U39RT (2)	U39RT (2)	U39RT (2) P39RT (2)	L39RT (1)	3 OVERLAPPING CRIMPS	1 CRIMP
	2	1.41	Red 18	W31RT (2) W31VT (2)	U31RT (2)	U31RT (2)	U31RT (2)	L31RT (1)	2 OVERLAPPING CRIMPS	1 CRIMP
YSR3930LTCKITC	1	1.67	Black 24	-	U39RT (2)	U39RT (2)	U39RT (2) P39RT (2)	L39RT (1)	3 OVERLAPPING CRIMPS	1 CRIMP
	2	1.24	White 17	W30RT (2) W30VT (2)	U30RT (2)	U30RT (2)	U30RT (2)	L30RT (1)	2 OVERLAPPING CRIMPS	1 CRIMP
YSR3929LTCKITC	1	1.67	Black 24	-	U39RT (2)	U39RT (2)	U39RT (2) P39RT (2)	L39RT (1)	3 OVERLAPPING CRIMPS	1 CRIMP
	2	1.38	Yellow 16	X29RT (4) W29RT (2) W29VT (2)	U29RT (1)	U29RT (1)	U29RT (1)	L29RT (1)	2 OVERLAPPING CRIMPS	1 CRIMP
YSR3929FXLTCKITC	1	1.67	Black 24	-	U39RT (2)	U39RT (2)	U39RT (2) P39RT (2)	L39RT (1)	3 OVERLAPPING CRIMPS	1 CRIMP
	2	1.38	Yellow 16	X29RT (4) W29RT (2) W29VT (2)	U29RT (1)	U29RT (1)	U29RT (1)	L29RT (1)	1 CRIMP	1 CRIMP
YSR3928LTCKITC	1	1.67	Black 24	-	U39RT (2)	U39RT (2)	U39RT (2) P39RT (2)	L39RT (1)	3 OVERLAPPING CRIMPS	1 CRIMP
	2	1.24	Purple 15	X28RT (3) W28RT (2) W28VT (2)	U28RT (1)	U28RT (1)	U28RT (1)	L28RT (1)	2 OVERLAPPING CRIMPS	1 CRIMP
YSR3928FXLTCKITC	1	1.67	Black 24	-	U39RT (2)	U39RT (2)	U39RT (2) P39RT (2)	L39RT (1)	3 OVERLAPPING CRIMPS	1 CRIMP
	2	1.36	Purple 15	X28RT (3) W28RT (2) W28VT (2)	U28RT (1)	U28RT (1)	U28RT (1)	L28RT (1)	1 CRIMP	1 CRIMP

TYPE YSR-TC (Continued)

HYDRAULIC INSTALLATION TOOLING CHART

Standard Barrel with Inspection Window

Kit Catalog Number	Barrel	Strip Length	Color Code & Die Index #	Hydraulic Tools Dies Required (# of Crimps)					Hydraulic Dieless Tools Number of Crimps	
				PATMD / 600 / 500 Series	750 / 35 Series	45 Series Use PT6515 with U Dies	46 Series Use PUADP1 with U Dies	60 Series	81K / 81K2 / 4PC Series	644 / 444S Series
YSR38FX34LTCKITC	1	1.77	Pink L99	-	U38XRT (2)	U38XRT (2)	U38XRT (2)	L38RT (1)	1 CRIMP	1 CRIMP
	2	1.60	Brown 20	W34RT (2) W34VT (2)	U34RT (2)	U34RT (2)	U34RT (2)	L34RT (1)	2 OVERLAPPING CRIMPS	1 CRIMP
YSR38FX34FXLTCKITC	1	1.77	Pink L99	-	U38XRT (2)	U38XRT (2)	U38XRT (2)	L38RT (1)	1 CRIMP	1 CRIMP
	2	1.60	Blue 19	W32RT (2) W32VT (2)	U32RT (2)	U32RT (2)	U32RT (2)	L34RT (1)	1 CRIMP	1 CRIMP
YSR38FX31LTCKITC	1	1.77	Pink L99	-	U38XRT (2)	U38XRT (2)	U38XRT (2)	L38RT (1)	1 CRIMP	1 CRIMP
	2	1.41	Red 18	W31RT (2) W31VT (2)	U31RT (2)	U31RT (2)	U31RT (2)	L31RT (1)	2 OVERLAPPING CRIMPS	1 CRIMP
YSR38FX30LTCKITC	1	1.77	Pink L99	-	U38XRT (2)	U38XRT (2)	U38XRT (2)	L38RT (1)	1 CRIMP	1 CRIMP
	2	1.24	White 17	W30RT (2) W30VT (2)	U30RT (2)	U30RT (2)	U30RT (2)	L30RT (1)	2 OVERLAPPING CRIMPS	1 CRIMP
YSR38FX29LTCKITC	1	1.77	Pink L99	-	U38XRT (2)	U38XRT (2)	U38XRT (2)	L38RT (1)	1 CRIMP	1 CRIMP
	2	1.38	Yellow 16	X29RT (4) W29RT (2) W29VT (2)	U29RT (1)	U29RT (1)	U29RT (1)	L29RT (1)	2 OVERLAPPING CRIMPS	1 CRIMP
YSR38FX29FXLTCKITC	1	1.77	Pink L99	-	U38XRT (2)	U38XRT (2)	U38XRT (2)	L38RT (1)	1 CRIMP	1 CRIMP
	2	1.38	Yellow 16	X29RT (4) W29RT (2) W29VT (2)	U29RT (1)	U29RT (1)	U29RT (1)	L29RT (1)	1 CRIMP	1 CRIMP
YSR38FX28FXLTCKITC	1	1.77	Pink L99	-	U38XRT (2)	U38XRT (2)	U38XRT (2)	L38RT (1)	1 CRIMP	1 CRIMP
	2	1.36	Purple 15	X28RT (3) W28RT (2) W28VT (2)	U28RT (1)	U28RT (1)	U28RT (1)	L28RT (1)	1 CRIMP	1 CRIMP
YSR38FX28LTCKITC	1	1.77	Pink L99	-	U38XRT (2)	U38XRT (2)	U38XRT (2)	L38RT (1)	1 CRIMP	1 CRIMP
	2	1.24	Purple 15	X28RT (3) W28RT (2) W28VT (2)	U28RT (1)	U28RT (1)	U28RT (1)	L28RT (1)	2 OVERLAPPING CRIMPS	1 CRIMP
YSR38FX26FXLTCKITC	1	1.77	Pink L99	-	U38XRT (2)	U38XRT (2)	U38XRT (2)	L38RT (1)	1 CRIMP	1 CRIMP
	2	1.09	Black 13	X26RT (2) W26RT (2) W26VT (2)	U26RT (1)	U26RT (1)	U26RT (1)	-	1 CRIMP	1 CRIMP
YSR3434FXLTCKITC	1	1.60	Brown 20	W34RT (2) W34VT (2)	U34RT (2)	U34RT (2)	U34RT (2)	L34RT (1)	2 OVERLAPPING CRIMPS	1 CRIMP
	2	1.60	Blue 19	W32RT (2) W32VT (2)	U32RT (2)	U32RT (2)	U32RT (2)	L34RT (1)	1 CRIMP	1 CRIMP
YSR3431LTCKITC	1	1.60	Brown 20	W34RT (2) W34VT (2)	U34RT (2)	U34RT (2)	U34RT (2)	L34RT (1)	2 OVERLAPPING CRIMPS	1 CRIMP
	2	1.41	Red 18	W31RT (2) W31VT (2)	U31RT (2)	U31RT (2)	U31RT (2)	L31RT (1)	2 OVERLAPPING CRIMPS	1 CRIMP
YSR3429FXLTCKITC	1	1.60	Brown 20	W34RT (2) W34VT (2)	U34RT (2)	U34RT (2)	U34RT (2)	L34RT (1)	2 OVERLAPPING CRIMPS	1 CRIMP
	2	1.38	Yellow 16	X29RT (4) W29RT (2) W29VT (2)	U29RT (1)	U29RT (1)	U29RT (1)	L29RT (1)	1 CRIMP	1 CRIMP

TYPE YSR-TC (Continued)

HYDRAULIC INSTALLATION TOOLING CHART

Standard Barrel with Inspection Window

Kit Catalog Number	Barrel	Strip Length	Color Code & Die Index #	Hydraulic Tools Dies Required (# of Crimps)					Hydraulic Dieless Tools Number of Crimps	
				PATMD / 600 / 500 Series	750 / 35 Series	45 Series Use PT6515 with U Dies	46 Series Use PUADP1 with U Dies	60 Series	81K / 81K2 / 4PC Series	644 / 444S Series
YSR3428LTCKITC	1	1.60	Brown 20	W34RT (2) W34VT (2)	U34RT (2)	U34RT (2)	U34RT (2)	L34RT (1)	2 OVERLAPPING CRIMPS	1 CRIMP
	2	1.24	Purple 15	X28RT (3) W28RT (2) W28VT (2)	U28RT (1)	U28RT (1)	U28RT (1)	L28RT (1)	2 OVERLAPPING CRIMPS	1 CRIMP
YSR3426FXLTCKITC	1	1.60	Brown 20	W34RT (2) W34VT (2)	U34RT (2)	U34RT (2)	U34RT (2)	L34RT (1)	2 OVERLAPPING CRIMPS	1 CRIMP
	2	1.09	Black 13	X26RT (2) W26RT (2) W26VT (2)	U26RT (1)	U26RT (1)	U26RT (1)	-	1 CRIMP	1 CRIMP
YSR3425FXLTCKITC	1	1.60	Brown 20	W34RT (2) W34VT (2)	U34RT (2)	U34RT (2)	U34RT (2)	L34RT (1)	2 OVERLAPPING CRIMPS	1 CRIMP
	2	1.00	Pink 12	X25RT (2) W25RT (2) W25VT (2)	U25RT (1)	U25RT (1)	U25RT (1)	-	1 CRIMP	1 CRIMP
YSR34FX31LTCKITC	1	1.60	Blue 19	W32RT (2) W32VT (2)	U32RT (2)	U32RT (2)	U32RT (2)	L34RT (1)	1 CRIMP	1 CRIMP
	2	1.41	Red 18	W31RT (2) W31VT (2)	U31RT (2)	U31RT (2)	U31RT (2)	L31RT (1)	2 OVERLAPPING CRIMPS	1 CRIMP
YSR34FX29FXLTCKITC	1	1.60	Blue 19	W32RT (2) W32VT (2)	U32RT (2)	U32RT (2)	U32RT (2)	L34RT (1)	1 CRIMP	1 CRIMP
	2	1.38	Yellow 16	X29RT (4) W29RT (2) W29VT (2)	U29RT (1)	U29RT (1)	U29RT (1)	L29RT (1)	1 CRIMP	1 CRIMP
YSR34FX28FXLTCKITC	1	1.60	Blue 19	W32RT (2) W32VT (2)	U32RT (2)	U32RT (2)	U32RT (2)	L34RT (1)	1 CRIMP	1 CRIMP
	2	1.36	Purple 15	X28RT (3) W28RT (2) W28VT (2)	U28RT (1)	U28RT (1)	U28RT (1)	L28RT (1)	1 CRIMP	1 CRIMP
YSR34FX28LTCKITC	1	1.60	Blue 19	W32RT (2) W32VT (2)	U32RT (2)	U32RT (2)	U32RT (2)	L34RT (1)	1 CRIMP	1 CRIMP
	2	1.24	Purple 15	X28RT (3) W28RT (2) W28VT (2)	U28RT (1)	U28RT (1)	U28RT (1)	L28RT (1)	2 OVERLAPPING CRIMPS	1 CRIMP
YSR34FX26FXLTCKITC	1	1.60	Blue 19	W32RT (2) W32VT (2)	U32RT (2)	U32RT (2)	U32RT (2)	L34RT (1)	1 CRIMP	1 CRIMP
	2	1.09	Black 13	X26RT (2) W26RT (2) W26VT (2)	U26RT (1)	U26RT (1)	U26RT (1)	-	1 CRIMP	1 CRIMP
YSR34FX25FXLTCKITC	1	1.60	Blue 19	W32RT (2) W32VT (2)	U32RT (2)	U32RT (2)	U32RT (2)	L34RT (1)	1 CRIMP	1 CRIMP
	2	1.00	Pink 12	X25RT (2) W25RT (2) W25VT (2)	U25RT (1)	U25RT (1)	U25RT (1)	-	1 CRIMP	1 CRIMP

TYPE YSR-TC (Continued)

HYDRAULIC INSTALLATION TOOLING CHART

Standard Barrel with Inspection Window

Kit Catalog Number	Barrel	Strip Length	Color Code & Die Index #	Hydraulic Tools Dies Required (# of Crimps)					Hydraulic Dieless Tools Number of Crimps	
				PATMD / 600 / 500 Series	750 / 35 Series	45 Series Use PT6515 with U Dies	46 Series Use PUADP1 with U Dies	60 Series	81K / 81K2 / 4PC Series	644 / 444S Series
YSR34FX2CFXLTKITC	1	1.60	Blue 19	W32RT (2) W32VT (2)	U32RT (2)	U32RT (2)	U32RT (2)	L34RT (1)	1 CRIMP	1 CRIMP
	2	0.78	Brown 10	X2CRT (1) W2CRT (1) W2CVT (1)	U2CRT (1)	U2CRT (1)	U2CRT (1)	-	1 CRIMP	1 CRIMP
YSR34FX4CFXLTKITC	1	1.60	Blue 19	W32RT (2) W32VT (2)	U32RT (2)	U32RT (2)	U32RT (2)	L34RT (1)	1 CRIMP	1 CRIMP
	2	0.71	Gray 8	X4CRT (1) W4CRT (1) W4CVT (1)	U4CRT (1)	U4CRT (1)	U4CRT (1)	-	1 CRIMP	-
YSR34FX6CFXLTKITC	1	1.60	Blue 19	W32RT (2) W32VT (2)	U32RT (2)	U32RT (2)	U32RT (2)	L34RT (1)	1 CRIMP	1 CRIMP
	2	0.70	Blue 7	X5CRT (1) W5CRT (1) W5CVT (1)	U5CRT (1)	U5CRT (1)	U5CRT (1)	-	1 CRIMP	-
YSR3129FXLTCKITC	1	1.41	Red 18	W31RT (2) W31VT (2)	U31RT (2)	U31RT (2)	U31RT (2)	L31RT (1)	2 OVERLAPPING CRIMPS	1 CRIMP
	2	1.38	Yellow 16	X29RT (4) W29RT (2) W29VT (2)	U29RT (1)	U29RT (1)	U29RT (1)	L29RT (1)	1 CRIMP	1 CRIMP
YSR3128FXLTCKITC	1	1.41	Red 18	W31RT (2) W31VT (2)	U31RT (2)	U31RT (2)	U31RT (2)	L31RT (1)	2 OVERLAPPING CRIMPS	1 CRIMP
	2	1.36	Purple 15	X28RT (3) W28RT (2) W28VT (2)	U28RT (1)	U28RT (1)	U28RT (1)	L28RT (1)	1 CRIMP	1 CRIMP
YSR3128LTCKITC	1	1.41	Red 18	W31RT (2) W31VT (2)	U31RT (2)	U31RT (2)	U31RT (2)	L31RT (1)	2 OVERLAPPING CRIMPS	1 CRIMP
	2	1.24	Purple 15	X28RT (3) W28RT (2) W28VT (2)	U28RT (1)	U28RT (1)	U28RT (1)	L28RT (1)	2 OVERLAPPING CRIMPS	1 CRIMP
YSR3126FXLTCKITC	1	1.41	Red 18	W31RT (2) W31VT (2)	U31RT (2)	U31RT (2)	U31RT (2)	L31RT (1)	2 OVERLAPPING CRIMPS	1 CRIMP
	2	1.10	Black 13	X26RT (2) W26RT (2) W26VT (2)	U26RT (1)	U26RT (1)	U26RT (1)	-	1 CRIMP	1 CRIMP
YSR3125FXLTCKITC	1	1.41	Red 18	W31RT (2) W31VT (2)	U31RT (2)	U31RT (2)	U31RT (2)	L31RT (1)	2 OVERLAPPING CRIMPS	1 CRIMP
	2	1.00	Pink 12	X25RT (2) W25RT (2) W25VT (2)	U25RT (1)	U25RT (1)	U25RT (1)	-	1 CRIMP	1 CRIMP
YSR312CFXLTKITC	1	1.41	Red 18	W31RT (2) W31VT (2)	U31RT (2)	U31RT (2)	U31RT (2)	L31RT (1)	2 OVERLAPPING CRIMPS	1 CRIMP
	2	0.78	Brown 10	X2CRT (1) W2CRT (1) W2CVT (1)	U2CRT (1)	U2CRT (1)	U2CRT (1)	-	1 CRIMP	1 CRIMP

Compression Connections

Copper — Code / Flex — Reducing Splice Kit
Standard Barrel — with Inspection Window

TYPE YSR-TC (Continued)

HYDRAULIC INSTALLATION TOOLING CHART

Standard Barrel with Inspection Window

Kit Catalog Number	Barrel	Strip Length	Color Code & Die Index #	Hydraulic Tools Dies Required (# of Crimps)					Hydraulic Dieless Tools Number of Crimps	
				PATMD / 600 / 500 Series	750 / 35 Series	45 Series Use PT6515 with U Dies	46 Series Use PUADP1 with U Dies	60 Series	81K / 81K2 / 4PC Series	644 / 444S Series
YSR314CFXLTCKITC	1	1.41	Red 18	W31RT (2) W31VT (2)	U31RT (2)	U31RT (2)	U31RT (2)	L31RT (1)	2 OVERLAPPING CRIMPS	1 CRIMP
	2	0.71	Gray 8	X4CRT (1) W4CRT (1) W4CVT (1)	U4CRT (1)	U4CRT (1)	U4CRT (1)	-	1 CRIMP	-
YSR316CFXLTCKITC	1	1.41	Red 18	W31RT (2) W31VT (2)	U31RT (2)	U31RT (2)	U31RT (2)	L31RT (1)	2 OVERLAPPING CRIMPS	1 CRIMP
	2	0.70	Blue 7	X5CRT (1) W5CRT (1) W5CVT (1)	U5CRT (1)	U5CRT (1)	U5CRT (1)	-	1 CRIMP	-
YSR32FX29FXLTCKITC	1	1.48	Red 18	W31RT (2) W31VT (2)	U31RT (2)	U31RT (2)	U31RT (2)	L32RT (2)	1 CRIMP	1 CRIMP
	2	1.38	Yellow 16	X29RT (4) W29RT (2) W29VT (2)	U29RT (1)	U29RT (1)	U29RT (1)	L29RT (1)	1 CRIMP	1 CRIMP
YSR32FX28FXLTCKITC	1	1.48	Red 18	W31RT (2) W31VT (2)	U31RT (2)	U31RT (2)	U31RT (2)	L32RT (2)	1 CRIMP	1 CRIMP
	2	1.36	Purple 15	X28RT (3) W28RT (2) W28VT (2)	U28RT (1)	U28RT (1)	U28RT (1)	L28RT (1)	1 CRIMP	1 CRIMP
YSR29FX28LTCKITC	1	1.38	Yellow 16	X29RT (4) W29RT (2) W29VT (2)	U29RT (1)	U29RT (1)	U29RT (1)	L29RT (1)	1 CRIMP	1 CRIMP
	2	1.24	Purple 15	X28RT (3) W28RT (2) W28VT (2)	U28RT (1)	U28RT (1)	U28RT (1)	L28RT (1)	2 OVERLAPPING CRIMPS	1 CRIMP
YSR29FX25FXLTCKITC	1	1.38	Yellow 16	X29RT (4) W29RT (2) W29VT (2)	U29RT (1)	U29RT (1)	U29RT (1)	L29RT (1)	1 CRIMP	1 CRIMP
	2	1.00	Pink 12	X25RT (2) W25RT (2) W25VT (2)	U25RT (1)	U25RT (1)	U25RT (1)	-	1 CRIMP	1 CRIMP
YSR29FX2CFXLTCKITC	1	1.38	Yellow 16	X29RT (4) W29RT (2) W29VT (2)	U29RT (1)	U29RT (1)	U29RT (1)	L29RT (1)	1 CRIMP	1 CRIMP
	2	0.78	Brown 10	X2CRT (1) W2CRT (1) W2CVT (1)	U2CRT (1)	U2CRT (1)	U2CRT (1)	-	1 CRIMP	1 CRIMP
YSR2825FXLTCKITC	1	1.24	Purple 15	X28RT (3) W28RT (2) W28VT (2)	U28RT (1)	U28RT (1)	U28RT (1)	L28RT (1)	2 OVERLAPPING CRIMPS	1 CRIMP
	2	1.00	Pink 12	X25RT (2) W25RT (2) W25VT (2)	U25RT (1)	U25RT (1)	U25RT (1)	-	1 CRIMP	1 CRIMP
YSR282CFXLTCKITC	1	1.24	Purple 15	X28RT (3) W28RT (2) W28VT (2)	U28RT (1)	U28RT (1)	U28RT (1)	L28RT (1)	2 OVERLAPPING CRIMPS	1 CRIMP
	2	0.78	Brown 10	X2CRT (1) W2CRT (1) W2CVT (1)	U2CRT (1)	U2CRT (1)	U2CRT (1)	-	1 CRIMP	1 CRIMP

TYPE YSR-TC (Continued)

HYDRAULIC INSTALLATION TOOLING CHART

Standard Barrel with Inspection Window

Kit Catalog Number	Barrel	Strip Length	Color Code & Die Index #	Hydraulic Tools Dies Required (# of Crimps)					Hydraulic Dieless Tools Number of Crimps	
				PATMD / 600 / 500 Series	750 / 35 Series	45 Series Use PT6515 with U Dies	46 Series Use PUADP1 with U Dies	60 Series	81K / 81K2 / 4PC Series	644 / 444S Series
YSR284CFXLTKITC	1	1.24	Purple 15	X28RT (3) W28RT (2) W28VT (2)	U28RT (1)	U28RT (1)	U28RT (1)	L28RT (1)	2 OVERLAPPING CRIMPS	1 CRIMP
	2	0.71	Gray 8	X4CRT (1) W4CRT (1) W4CVT (1)	U4CRT (1)	U4CRT (1)	U4CRT (1)	-	1 CRIMP	-
YSR286CFXLTKITC	1	1.24	Purple 15	X28RT (3) W28RT (2) W28VT (2)	U28RT (1)	U28RT (1)	U28RT (1)	L28RT (1)	2 OVERLAPPING CRIMPS	1 CRIMP
	2	0.70	Blue 7	X5CRT (1) W5CRT (1) W5CVT (1)	U5CRT (1)	U5CRT (1)	U5CRT (1)	-	1 CRIMP	-
YSR28FX28LTCKITC	1	1.36	Purple 15	X28RT (3) W28RT (2) W28VT (2)	U28RT (1)	U28RT (1)	U28RT (1)	L28RT (1)	1 CRIMP	1 CRIMP
	2	1.24	Purple 15	X28RT (3) W28RT (2) W28VT (2)	U28RT (1)	U28RT (1)	U28RT (1)	L28RT (1)	2 OVERLAPPING CRIMPS	1 CRIMP
YSR28FX26FXLTCKITC	1	1.36	Purple 15	X28RT (3) W28RT (2) W28VT (2)	U28RT (1)	U28RT (1)	U28RT (1)	L28RT (1)	1 CRIMP	1 CRIMP
	2	1.19	Black 13	X26RT (2) W26RT (2) W26VT (2)	U26RT (1)	U26RT (1)	U26RT (1)	-	1 CRIMP	1 CRIMP
YSR28FX25FXLTCKITC	1	1.36	Purple 15	X28RT (3) W28RT (2) W28VT (2)	U28RT (1)	U28RT (1)	U28RT (1)	L28RT (1)	1 CRIMP	1 CRIMP
	2	1.00	Pink 12	X25RT (2) W25RT (2) W25VT (2)	U25RT (1)	U25RT (1)	U25RT (1)	-	1 CRIMP	1 CRIMP
YSR28FX2CFXLTKITC	1	1.36	Purple 15	X28RT (3) W28RT (2) W28VT (2)	U28RT (1)	U28RT (1)	U28RT (1)	L28RT (1)	1 CRIMP	1 CRIMP
	2	0.78	Brown 10	X2CRT (1) W2CRT (1) W2CVT (1)	U2CRT (1)	U2CRT (1)	U2CRT (1)	-	1 CRIMP	1 CRIMP
YSR28FX4CFXLTKITC	1	1.36	Purple 15	X28RT (3) W28RT (2) W28VT (2)	U28RT (1)	U28RT (1)	U28RT (1)	L28RT (1)	1 CRIMP	1 CRIMP
	2	0.71	Gray 8	X4CRT (1) W4CRT (1) W4CVT (1)	U4CRT (1)	U4CRT (1)	U4CRT (1)	-	1 CRIMP	-
YSR26FX25FXLTCKITC	1	1.10	Black 13	X26RT (2) W26RT (2) W26VT (2)	U26RT (1)	U26RT (1)	U26RT (1)	-	1 CRIMP	1 CRIMP
	2	1.00	Pink 12	X25RT (2) W25RT (2) W25VT (2)	U25RT (1)	U25RT (1)	U25RT (1)	-	1 CRIMP	1 CRIMP

Compression Connections

Copper — Code / Flex — Reducing Splice Kit
Standard Barrel — with Inspection Window

TYPE YSR-TC (Continued)

HYDRAULIC INSTALLATION TOOLING CHART

Standard Barrel with Inspection Window

Kit Catalog Number	Barrel	Strip Length	Color Code & Die Index #	Hydraulic Tools Dies Required (# of Crimps)					Hydraulic Dieless Tools Number of Crimps	
				PATMD / 600 / 500 Series	750 / 35 Series	45 Series Use PT6515 with U Dies	46 Series Use PUADP1 with U Dies	60 Series	81K / 81K2 / 4PC Series	644 / 444S Series
YSR26FX2CFXLTKITC	1	1.10	Black 13	X26RT (2) W26RT (2) W26VT (2)	U26RT (1)	U26RT (1)	U26RT (1)	-	1 CRIMP	1 CRIMP
	2	0.78	Brown 10	X2CRT (1) W2CRT (1) W2CVT (1)	U2CRT (1)	U2CRT (1)	U2CRT (1)	-	1 CRIMP	1 CRIMP
YSR26FX4CFXLTKITC	1	1.10	Black 13	X26RT (2) W26RT (2) W26VT (2)	U26RT (1)	U26RT (1)	U26RT (1)	-	1 CRIMP	1 CRIMP
	2	0.71	Gray 8	X4CRT (1) W4CRT (1) W4CVT (1)	U4CRT (1)	U4CRT (1)	U4CRT (1)	-	1 CRIMP	-
YSR26FX6CFXLTKITC	1	1.10	Black 13	X26RT (2) W26RT (2) W26VT (2)	U26RT (1)	U26RT (1)	U26RT (1)	-	1 CRIMP	1 CRIMP
	2	0.70	Blue 7	X5CRT (1) W5CRT (1) W5CVT (1)	U5CRT (1)	U5CRT (1)	U5CRT (1)	-	1 CRIMP	-
YSR25FX2CFXLTKITC	1	1.00	Pink 12	X25RT (2) W25RT (2) W25VT (2)	U25RT (1)	U25RT (1)	U25RT (1)	-	1 CRIMP	1 CRIMP
	2	0.76	Brown 10	X2CRT (1) W2CRT (1) W2CVT (1)	U2CRT (1)	U2CRT (1)	U2CRT (1)	-	1 CRIMP	1 CRIMP
YSR25FX4CFXLTKITC	1	1.00	Pink 12	X25RT (2) W25RT (2) W25VT (2)	U25RT (1)	U25RT (1)	U25RT (1)	-	1 CRIMP	1 CRIMP
	2	0.62	Gray 8	X4CRT (1) W4CRT (1) W4CVT (1)	U4CRT (1)	U4CRT (1)	U4CRT (1)	-	1 CRIMP	-
YSR25FX6CFXLTKITC	1	1.00	Pink 12	X25RT (2) W25RT (2) W25VT (2)	U25RT (1)	U25RT (1)	U25RT (1)	-	1 CRIMP	1 CRIMP
	2	0.61	Blue 7	X5CRT (1) W5CRT (1) W5CVT (1)	U5CRT (1)	U5CRT (1)	U5CRT (1)	-	1 CRIMP	-
YSR25FX8CFXLTKITC	1	1.01	Pink 12	X25RT (2) W25RT (2) W25VT (2)	U25RT (1)	U25RT (1)	U25RT (1)	-	1 CRIMP	1 CRIMP
	2	0.60	Red 49	X8CRT (1) W8CRT (1) W8CVT (1)	U8CRT (1)	U8CRT (1)	U8CRT (1)	-	1 CRIMP	-
YSR2CFX4CFXLTKITC	1	0.78	Brown 10	X2CRT (1) W2CRT (1) W2CVT (1)	U2CRT (1)	U2CRT (1)	U2CRT (1)	-	1 CRIMP	1 CRIMP
	2	0.63	Gray 8	X4CRT (1) W4CRT (1) W4CVT (1)	U4CRT (1)	U4CRT (1)	U4CRT (1)	-	1 CRIMP	-

TYPE YSR-TC (Continued)

HYDRAULIC INSTALLATION TOOLING CHART

Standard Barrel with Inspection Window

Kit Catalog Number	Barrel	Strip Length	Color Code & Die Index #	Hydraulic Tools Dies Required (# of Crimps)					Hydraulic Dieless Tools Number of Crimps	
				PATMD / 600 / 500 Series	750 / 35 Series	45 Series Use PT6515 with U Dies	46 Series Use PUADP1 with U Dies	60 Series	81K / 81K2 / 4PC Series	644 / 444S Series
YSR2CFX6CFXLTKITC	1	0.78	Brown 10	X2CRT (1) W2CRT (1) W2CVT (1)	U2CRT (1)	U2CRT (1)	U2CRT (1)	-	1 CRIMP	1 CRIMP
	2	0.61	Blue 7	X5CRT (1) W5CRT (1) W5CVT (1)	U5CRT (1)	U5CRT (1)	U5CRT (1)	-	1 CRIMP	-
YSR2CFX8CFXLTKITC	1	0.78	Brown 10	X2CRT (1) W2CRT (1) W2CVT (1)	U2CRT (1)	U2CRT (1)	U2CRT (1)	-	1 CRIMP	1 CRIMP
	2	0.60	Red 49	X8CRT (1) W8CRT (1) W8CVT (1)	U8CRT (1)	U8CRT (1)	U8CRT (1)	-	1 CRIMP	-
YSR4CFX6CFXLTKITC	1	0.71	Gray 8	X4CRT (1) W4CRT (1) W4CVT (1)	U4CRT (1)	U4CRT (1)	U4CRT (1)	-	1 CRIMP	-
	2	0.61	Blue 7	X5CRT (1) W5CRT (1) W5CVT (1)	U5CRT (1)	U5CRT (1)	U5CRT (1)	-	1 CRIMP	-
YSR4CFX8CFXLTKITC	1	0.71	Gray 8	X4CRT (1) W4CRT (1) W4CVT (1)	U4CRT (1)	U4CRT (1)	U4CRT (1)	-	1 CRIMP	-
	2	0.60	Red 49	X8CRT (1) W8CRT (1) W8CVT (1)	U8CRT (1)	U8CRT (1)	U8CRT (1)	-	1 CRIMP	-
YSR4CFX10CLTKITC	1	0.71	Gray 8	X4CRT (1) W4CRT (1) W4CVT (1)	U4CRT (1)	U4CRT (1)	U4CRT (1)	-	1 CRIMP	-
	2	0.65	-	-	-	-	-	-	-	-
YSR6CFX8CFXLTKITC	1	0.70	Blue 7	X5CRT (1) W5CRT (1) W5CVT (1)	U5CRT (1)	U5CRT (1)	U5CRT (1)	-	1 CRIMP	-
	2	0.57	Red 49	X8CRT (1) W8CRT (1) W8CVT (1)	U8CRT (1)	U8CRT (1)	U8CRT (1)	-	1 CRIMP	-
YSR6CFX10CLTKITC	1	0.70	Blue 7	X5CRT (1) W5CRT (1) W5CVT (1)	U5CRT (1)	U5CRT (1)	U5CRT (1)	-	1 CRIMP	-
	2	0.63	-	-	-	-	-	-	-	-
YSR6CFX14CLTKITC	1	0.70	Blue 7	X5CRT (1) W5CRT (1) W5CVT (1)	U5CRT (1)	U5CRT (1)	U5CRT (1)	-	1 CRIMP	-
	2	0.63	-	-	-	-	-	-	-	-
YSR8CFX10CLTKITC	1	0.57	Red 49	X8CRT (1) W8CRT (1) W8CVT (1)	U8CRT (1)	U8CRT (1)	U8CRT (1)	-	1 CRIMP	-
	2	0.63	-	-	-	-	-	-	-	-

TYPE YSR-TC (Continued)

HYDRAULIC INSTALLATION TOOLING CHART

Standard Barrel with Inspection Window

Kit Catalog Number	Barrel	Strip Length	Color Code & Die Index #	Hydraulic Tools Dies Required (# of Crimps)					Hydraulic Dieless Tools Number of Crimps	
				PATMD / 600 / 500 Series	750 / 35 Series	45 Series Use PT6515 with U Dies	46 Series Use PUADP1 with U Dies	60 Series	81K / 81K2 / 4PC Series	644 / 444S Series
YSR8CFX14CLTCKITC	1	0.57	Red 49	X8CRT (1) W8CRT (1) W8CVT (1)	U8CRT (1)	U8CRT (1)	U8CRT (1)	-	1 CRIMP	-
	2	0.63	-	-	-	-	-	-	-	-
YSR10CFX12CLTCKITC	1	0.63	-	-	-	-	-	-	-	-
	2	0.63	-	-	-	-	-	-	-	-
YSR10CFX14CLTCKITC	1	0.63	-	-	-	-	-	-	-	-
	2	0.63	-	-	-	-	-	-	-	-

TYPE YSR-TC (Continued)

MECHANICAL INSTALLATION TOOLING CHART

Standard Barrel with Inspection Window

Kit Catalog Number	Barrel	Strip Length	Color Code & Die Index #	Mechanical & Ratchet Dies Required (# of Crimps)		Mechanical & Ratchet Dedicated Die Tools Number of Crimps				
				MD6 / MD7 Series	OUR840	MY28 / MY29 Series	MRC840	MRE1022B / Y8MRB1 / Y10D / Y1022	Y122CMR	Y1MRTC
YSR44FX39LTCKITC	1	1.96	Yellow L115	-	-	-	-	-	-	-
	2	1.67	Black 24	-	-	-	-	-	-	-
YSR44FX38FXLTCKITC	1	1.96	Yellow L115	-	-	-	-	-	-	-
	2	1.77	Pink L99	-	-	-	-	-	-	-
YSR44FX34LTCKITC	1	1.96	Yellow L115	-	-	-	-	-	-	-
	2	1.60	Brown 20	W34RT (2)* W34VT (2)	-	-	-	-	-	-
YSR44FX34FXLTCKITC	1	1.96	Yellow L115	-	-	-	-	-	-	-
	2	1.60	Blue 19	W32RT (2)* W32VT (2)	-	-	-	-	-	-
YSR44FX31LTCKITC	1	1.96	Yellow L115	-	-	-	-	-	-	-
	2	1.41	Red 18	W31RT (2)* W31VT (2)	-	-	-	-	-	-
YSR44FX30LTCKITC	1	1.96	Yellow L115	-	-	-	-	-	-	-
	2	1.24	White 17	W30RT (2)* W30VT (2)	-	-	-	-	-	-
YSR44FX29LTCKITC	1	1.96	Yellow L115	-	-	-	-	-	-	-
	2	1.38	Yellow 16	X29RT (4) W29RT (2) W29VT (2)	X29RT (4) W29RT (2)* W29VT (2)*	1 CRIMP	-	-	-	-
YSR44FX29FXLTCKITC	1	1.96	Yellow L115	-	-	-	-	-	-	-
	2	1.38	Yellow 16	X29RT (4) W29RT (2) W29VT (2)	X29RT (4) W29RT (2)* W29VT (2)*	1 CRIMP	-	-	-	-
YSR44FX28LTCKITC	1	1.96	Yellow L115	-	-	-	-	-	-	-
	2	1.24	Purple 15	X28RT (3) W28RT (2) W28VT (2)	X28RT (3) W28RT (2)* W28VT (2)*	1 CRIMP	2 CRIMPS	-	-	-
YSR44FX28FXLTCKITC	1	1.96	Yellow L115	-	-	-	-	-	-	-
	2	1.36	Purple 15	X28RT (3) W28RT (2) W28VT (2)	X28RT (3) W28RT (2)* W28VT (2)*	1 CRIMP	2 CRIMPS	-	-	-
YSR3939LTCKITC	1	1.67	Black 24	-	-	-	-	-	-	-
	2	1.67	Black 24	-	-	-	-	-	-	-
YSR3938FXLTCKITC	1	1.67	Black 24	-	-	-	-	-	-	-
	2	1.77	Pink L99	-	-	-	-	-	-	-
YSR3934LTCKITC	1	1.67	Black 24	-	-	-	-	-	-	-
	2	1.60	Brown 20	W34RT (2)* W34VT (2)	-	-	-	-	-	-
YSR3934FXLTCKITC	1	1.67	Black 24	-	-	-	-	-	-	-
	2	1.60	Blue 19	W32RT (2)* W32VT (2)	-	-	-	-	-	-

* Not recommended due to handle force required for proper installation.

Compression Connections

Copper — Code / Flex — Reducing Splice Kit
Standard Barrel — with Inspection Window

TYPE YSR-TC (Continued)

MECHANICAL INSTALLATION TOOLING CHART

Standard Barrel with Inspection Window

Kit Catalog Number	Barrel	Strip Length	Color Code & Die Index #	Mechanical & Ratchet Dies Required (# of Crimps)		Mechanical & Ratchet Dedicated Die Tools Number of Crimps				
				MD6 / MD7 Series	OUR840	MY28 / MY29 Series	MRC840	MRE1022B / Y8MRB1 / Y10D / Y1022	Y122CMR	Y1MRTC
YSR3931LTCKITC	1	1.67	Black 24	-	-	-	-	-	-	-
	2	1.41	Red 18	W31RT (2)* W31VT (2)	-	-	-	-	-	-
YSR3930LTCKITC	1	1.67	Black 24	-	-	-	-	-	-	-
	2	1.24	White 17	W30RT (2)* W30VT (2)	-	-	-	-	-	-
YSR3929LTCKITC	1	1.67	Black 24	-	-	-	-	-	-	-
	2	1.38	Yellow 16	X29RT (4) W29RT (2) W29VT (2)	X29RT (4) W29RT (2)* W29VT (2)*	1 CRIMP	-	-	-	-
YSR3929FXLTCKITC	1	1.67	Black 24	-	-	-	-	-	-	-
	2	1.38	Yellow 16	X29RT (4) W29RT (2) W29VT (2)	X29RT (4) W29RT (2)* W29VT (2)*	1 CRIMP	-	-	-	-
YSR3928LTCKITC	1	1.67	Black 24	-	-	-	-	-	-	-
	2	1.24	Purple 15	X28RT (3) W28RT (2) W28VT (2)	X28RT (3) W28RT (2)* W28VT (2)*	1 CRIMP	2 CRIMPS	-	-	-
YSR3928FXLTCKITC	1	1.67	Black 24	-	-	-	-	-	-	-
	2	1.36	Purple 15	X28RT (3) W28RT (2) W28VT (2)	X28RT (3) W28RT (2)* W28VT (2)*	1 CRIMP	2 CRIMPS	-	-	-
YSR38FX34LTCKITC	1	1.77	Pink L99	-	-	-	-	-	-	-
	2	1.60	Brown 20	W34RT (2)* W34VT (2)	-	-	-	-	-	-
YSR38FX34FXLTCKITC	1	1.77	Pink L99	-	-	-	-	-	-	-
	2	1.60	Blue 19	W32RT (2)* W32VT (2)	-	-	-	-	-	-
YSR38FX31LTCKITC	1	1.77	Pink L99	-	-	-	-	-	-	-
	2	1.41	Red 18	W31RT (2)* W31VT (2)	-	-	-	-	-	-
YSR38FX30LTCKITC	1	1.77	Pink L99	-	-	-	-	-	-	-
	2	1.24	White 17	W30RT (2)* W30VT (2)	-	-	-	-	-	-
YSR38FX29LTCKITC	1	1.77	Pink L99	-	-	-	-	-	-	-
	2	1.38	Yellow 16	X29RT (4) W29RT (2) W29VT (2)	X29RT (4) W29RT (2)* W29VT (2)*	1 CRIMP	-	-	-	-
YSR38FX29FXLTCKITC	1	1.77	Pink L99	-	-	-	-	-	-	-
	2	1.38	Yellow 16	X29RT (4) W29RT (2) W29VT (2)	X29RT (4) W29RT (2)* W29VT (2)*	1 CRIMP	-	-	-	-

* Not recommended due to handle force required for proper installation.

TYPE YSR-TC (Continued)

MECHANICAL INSTALLATION TOOLING CHART

Standard Barrel with Inspection Window

Kit Catalog Number	Barrel	Strip Length	Color Code & Die Index #	Mechanical & Ratchet Dies Required (# of Crimps)		Mechanical & Ratchet Dedicated Die Tools Number of Crimps				
				MD6 / MD7 Series	OUR840	MY28 / MY29 Series	MRC840	MRE1022B / Y8MRB1 / Y10D / Y1022	Y122CMR	Y1MRTC
YSR38FX28FXLTCKITC	1	1.77	Pink L99	-	-	-	-	-	-	-
	2	1.36	Purple 15	X28RT (3) W28RT (2) W28VT (2)	X28RT (3) W28RT (2)* W28VT (2)*	1 CRIMP	2 CRIMPS	-	-	-
YSR38FX28LTCKITC	1	1.77	Pink L99	-	-	-	-	-	-	-
	2	1.24	Purple 15	X28RT (3) W28RT (2) W28VT (2)	X28RT (3) W28RT (2)* W28VT (2)*	1 CRIMP	2 CRIMPS	-	-	-
YSR38FX26FXLTCKITC	1	1.77	Pink L99	-	-	-	-	-	-	-
	2	1.09	Black 13	X26RT (2) W26RT (2) W26VT (2)	X26RT (2) W26RT (2)* W26VT (2)*	1 CRIMP	2 CRIMPS	-	-	-
YSR3434FXLTCKITC	1	1.60	Brown 20	W34RT (2)* W34VT (2)	-	-	-	-	-	-
	2	1.60	Blue 19	W32RT (2)* W32VT (2)	-	-	-	-	-	-
YSR3431LTCKITC	1	1.60	Brown 20	W34RT (2)* W34VT (2)	-	-	-	-	-	-
	2	1.41	Red 18	W31RT (2)* W31VT (2)	-	-	-	-	-	-
YSR3429FXLTCKITC	1	1.60	Brown 20	W34RT (2)* W34VT (2)	-	-	-	-	-	-
	2	1.38	Yellow 16	X29RT (4) W29RT (2) W29VT (2)	X29RT (4) W29RT (2)* W29VT (2)*	1 CRIMP	-	-	-	-
YSR3428LTCKITC	1	1.60	Brown 20	W34RT (2)* W34VT (2)	-	-	-	-	-	-
	2	1.24	Purple 15	X28RT (3) W28RT (2) W28VT (2)	X28RT (3) W28RT (2)* W28VT (2)*	1 CRIMP	2 CRIMPS	-	-	-
YSR3426FXLTCKITC	1	1.60	Brown 20	W34RT (2)* W34VT (2)	-	-	-	-	-	-
	2	1.09	Black 13	X26RT (2) W26RT (2) W26VT (2)	X26RT (2) W26RT (2)* W26VT (2)*	1 CRIMP	2 CRIMPS	-	-	-
YSR3425FXLTCKITC	1	1.60	Brown 20	W34RT (2)* W34VT (2)	-	-	-	-	-	-
	2	1.00	Pink 12	X25RT (2) W25RT (2) W25VT (2)	X25RT (2) W25RT (2)* W25VT (2)*	1 CRIMP	2 CRIMPS	-	-	-
YSR34FX31LTCKITC	1	1.60	Blue 19	W32RT (2)* W32VT (2)	-	-	-	-	-	-
	2	1.41	Red 18	W31RT (2)* W31VT (2)	-	-	-	-	-	-

* Not recommended due to handle force required for proper installation.

Compression Connections

Copper — Code / Flex — Reducing Splice Kit
Standard Barrel — with Inspection Window

TYPE YSR-TC (Continued)

MECHANICAL INSTALLATION TOOLING CHART

Standard Barrel with Inspection Window

Kit Catalog Number	Barrel	Strip Length	Color Code & Die Index #	Mechanical & Ratchet Dies Required (# of Crimps)		Mechanical & Ratchet Dedicated Die Tools Number of Crimps				
				MD6 / MD7 Series	OUR840	MY28 / MY29 Series	MRC840	MRE1022B / Y8MRB1 / Y10D / Y1022	Y122CMR	Y1MRTC
YSR34FX29FXLTCKITC	1	1.60	Blue 19	W32RT (2)* W32VT (2)	-	-	-	-	-	-
	2	1.38	Yellow 16	X29RT (4) W29RT (2) W29VT (2)	X29RT (4) W29RT (2)* W29VT (2)*	1 CRIMP	-	-	-	-
YSR34FX28FXLTCKITC	1	1.60	Blue 19	W32RT (2)* W32VT (2)	-	-	-	-	-	-
	2	1.36	Purple 15	X28RT (3) W28RT (2) W28VT (2)	X28RT (3) W28RT (2)* W28VT (2)*	1 CRIMP	2 CRIMPS	-	-	-
YSR34FX28LTCKITC	1	1.60	Blue 19	W32RT (2)* W32VT (2)	-	-	-	-	-	-
	2	1.24	Purple 15	X28RT (3) W28RT (2) W28VT (2)	X28RT (3) W28RT (2)* W28VT (2)*	1 CRIMP	2 CRIMPS	-	-	-
YSR34FX26FXLTCKITC	1	1.60	Blue 19	W32RT (2)* W32VT (2)	-	-	-	-	-	-
	2	1.09	Black 13	X26RT (2) W26RT (2) W26VT (2)	X26RT (2) W26RT (2)* W26VT (2)*	1 CRIMP	2 CRIMPS	-	-	-
YSR34FX25FXLTCKITC	1	1.60	Blue 19	W32RT (2)* W32VT (2)	-	-	-	-	-	-
	2	1.00	Pink 12	X25RT (2) W25RT (2) W25VT (2)	X25RT (2) W25RT (2)* W25VT (2)*	1 CRIMP	2 CRIMPS	-	-	-
YSR34FX2CFXLTCKITC	1	1.60	Blue 19	W32RT (2)* W32VT (2)	-	-	-	-	-	-
	2	0.78	Brown 10	X2CRT (1) W2CRT (1) W2CVT (1)	X2CRT (1)	1 CRIMP	1 CRIMP	-	2 CRIMPS	2 CRIMPS
YSR34FX4CFXLTCKITC	1	1.60	Blue 19	W32RT (2)* W32VT (2)	-	-	-	-	-	-
	2	0.71	Gray 8	X4CRT (1) W4CRT (1) W4CVT (1)	X4CRT (1)	1 CRIMP	1 CRIMP	-	2 CRIMPS	2 CRIMPS
YSR34FX6CFXLTCKITC	1	1.60	Blue 19	W32RT (2)* W32VT (2)	-	-	-	-	-	-
	2	0.70	Blue 7	X5CRT (1) W5CRT (1) W5CVT (1)	X5CRT (1)	1 CRIMP	1 CRIMP	-	1 CRIMP	1 CRIMP
YSR3129FXLTCKITC	1	1.41	Red 18	W31RT (2)* W31VT (2)	-	-	-	-	-	-
	2	1.38	Yellow 16	X29RT (4) W29RT (2) W29VT (2)	X29RT (4) W29RT (2)* W29VT (2)*	1 CRIMP	-	-	-	-

* Not recommended due to handle force required for proper installation.

TYPE YSR-TC (Continued)

MECHANICAL INSTALLATION TOOLING CHART

Standard Barrel with Inspection Window

Kit Catalog Number	Barrel	Strip Length	Color Code & Die Index #	Mechanical & Ratchet Dies Required (# of Crimps)		Mechanical & Ratchet Dedicated Die Tools Number of Crimps				
				MD6 / MD7 Series	OUR840	MY28 / MY29 Series	MRC840	MRE1022B / Y8MRB1 / Y10D / Y1022	Y122CMR	Y1MRTC
YSR3128FXLTCKITC	1	1.41	Red 18	W31RT (2)* W31VT (2)	-	-	-	-	-	-
	2	1.36	Purple 15	X28RT (3) W28RT (2) W28VT (2)	X28RT (3) W28RT (2)* W28VT (2)*	1 CRIMP	2 CRIMPS	-	-	-
YSR3128LTCKITC	1	1.41	Red 18	W31RT (2)* W31VT (2)	-	-	-	-	-	-
	2	1.24	Purple 15	X28RT (3) W28RT (2) W28VT (2)	X28RT (3) W28RT (2)* W28VT (2)*	1 CRIMP	2 CRIMPS	-	-	-
YSR3126FXLTCKITC	1	1.41	Red 18	W31RT (2)* W31VT (2)	-	-	-	-	-	-
	2	1.10	Black 13	X26RT (2) W26RT (2) W26VT (2)	X26RT (2) W26RT (2)* W26VT (2)*	1 CRIMP	2 CRIMPS	-	-	-
YSR3125FXLTCKITC	1	1.41	Red 18	W31RT (2)* W31VT (2)	-	-	-	-	-	-
	2	1.00	Pink 12	X25RT (2) W25RT (2) W25VT (2)	X25RT (2) W25RT (2)* W25VT (2)*	1 CRIMP	2 CRIMPS	-	-	-
YSR312CFXLTCKITC	1	1.41	Red 18	W31RT (2)* W31VT (2)	-	-	-	-	-	-
	2	0.78	Brown 10	X2CRT (1) W2CRT (1) W2CVT (1)	X2CRT (1)	1 CRIMP	1 CRIMP	-	2 CRIMPS	2 CRIMPS
YSR314CFXLTCKITC	1	1.41	Red 18	W31RT (2)* W31VT (2)	-	-	-	-	-	-
	2	0.71	Gray 8	X4CRT (1) W4CRT (1) W4CVT (1)	X4CRT (1)	1 CRIMP	1 CRIMP	-	2 CRIMPS	2 CRIMPS
YSR316CFXLTCKITC	1	1.41	Red 18	W31RT (2)* W31VT (2)	-	-	-	-	-	-
	2	0.70	Blue 7	X5CRT (1) W5CRT (1) W5CVT (1)	X5CRT (1)	1 CRIMP	1 CRIMP	-	1 CRIMP	1 CRIMP
YSR32FX29FXLTCKITC	1	1.48	Red 18	W31RT (2)* W31VT (2)	-	-	-	-	-	-
	2	1.38	Yellow 16	X29RT (4) W29RT (2) W29VT (2)	X29RT (4) W29RT (2)* W29VT (2)*	1 CRIMP	-	-	-	-
YSR32FX28FXLTCKITC	1	1.48	Red 18	W31RT (2)* W31VT (2)	-	-	-	-	-	-
	2	1.36	Purple 15	X28RT (3) W28RT (2) W28VT (2)	X28RT (3) W28RT (2)* W28VT (2)*	1 CRIMP	2 CRIMPS	-	-	-

* Not recommended due to handle force required for proper installation.

Compression Connections

Copper — Code / Flex — Reducing Splice Kit
Standard Barrel — with Inspection Window

TYPE YSR-TC (Continued)

MECHANICAL INSTALLATION TOOLING CHART

Standard Barrel with Inspection Window

Kit Catalog Number	Barrel	Strip Length	Color Code & Die Index #	Mechanical & Ratchet Dies Required (# of Crimps)		Mechanical & Ratchet Dedicated Die Tools Number of Crimps				
				MD6 / MD7 Series	OUR840	MY28 / MY29 Series	MRC840	MRE1022B / Y8MRB1 / Y10D / Y1022	Y122CMR	Y1MRTC
YSR29FX28LTCKITC	1	1.38	Yellow 16	X29RT (4) W29RT (2) W29VT (2)	X29RT (4) W29RT (2)* W29VT (2)*	1 CRIMP	-	-	-	-
	2	1.24	Purple 15	X28RT (3) W28RT (2) W28VT (2)	X28RT (3) W28RT (2)* W28VT (2)*	1 CRIMP	2 CRIMPS	-	-	-
YSR29FX25FXLTCKITC	1	1.38	Yellow 16	X29RT (4) W29RT (2) W29VT (2)	X29RT (4) W29RT (2)* W29VT (2)*	1 CRIMP	-	-	-	-
	2	1.00	Pink 12	X25RT (2) W25RT (2) W25VT (2)	X25RT (2) W25RT (2)* W25VT (2)*	1 CRIMP	2 CRIMPS	-	-	-
YSR29FX2CFXLTCKITC	1	1.38	Yellow 16	X29RT (4) W29RT (2) W29VT (2)	X29RT (4) W29RT (2)* W29VT (2)*	1 CRIMP	-	-	-	-
	2	0.78	Brown 10	X2CRT (1) W2CRT (1) W2CVT (1)	X2CRT (1)	1 CRIMP	1 CRIMP	-	2 CRIMPS	2 CRIMPS
YSR2825FXLTCKITC	1	1.24	Purple 15	X28RT (3) W28RT (2) W28VT (2)	X28RT (3) W28RT (2)* W28VT (2)*	1 CRIMP	2 CRIMPS	-	-	-
	2	1.00	Pink 12	X25RT (2) W25RT (2) W25VT (2)	X25RT (2) W25RT (2)* W25VT (2)*	1 CRIMP	2 CRIMPS	-	-	-
YSR282CFXLTCKITC	1	1.24	Purple 15	X28RT (3) W28RT (2) W28VT (2)	X28RT (3) W28RT (2)* W28VT (2)*	1 CRIMP	2 CRIMPS	-	-	-
	2	0.78	Brown 10	X2CRT (1) W2CRT (1) W2CVT (1)	X2CRT (1)	1 CRIMP	1 CRIMP	-	2 CRIMPS	2 CRIMPS
YSR284CFXLTCKITC	1	1.24	Purple 15	X28RT (3) W28RT (2) W28VT (2)	X28RT (3) W28RT (2)* W28VT (2)*	1 CRIMP	2 CRIMPS	-	-	-
	2	0.71	Gray 8	X4CRT (1) W4CRT (1) W4CVT (1)	X4CRT (1)	1 CRIMP	1 CRIMP	-	2 CRIMPS	2 CRIMPS
YSR286CFXLTCKITC	1	1.24	Purple 15	X28RT (3) W28RT (2) W28VT (2)	X28RT (3) W28RT (2)* W28VT (2)*	1 CRIMP	2 CRIMPS	-	-	-
	2	0.70	Blue 7	X5CRT (1) W5CRT (1) W5CVT (1)	X5CRT (1)	1 CRIMP	1 CRIMP	-	1 CRIMP	1 CRIMP
YSR28FX28LTCKITC	1	1.36	Purple 15	X28RT (3) W28RT (2) W28VT (2)	X28RT (3) W28RT (2)* W28VT (2)*	1 CRIMP	2 CRIMPS	-	-	-
	2	1.24	Purple 15	X28RT (3) W28RT (2) W28VT (2)	X28RT (3) W28RT (2)* W28VT (2)*	1 CRIMP	2 CRIMPS	-	-	-

* Not recommended due to handle force required for proper installation.

TYPE YSR-TC (Continued)

MECHANICAL INSTALLATION TOOLING CHART

Standard Barrel with Inspection Window

Kit Catalog Number	Barrel	Strip Length	Color Code & Die Index #	Mechanical & Ratchet Dies Required (# of Crimps)		Mechanical & Ratchet Dedicated Die Tools Number of Crimps				
				MD6 / MD7 Series	OUR840	MY28 / MY29 Series	MRC840	MRE1022B / Y8MRB1 / Y10D / Y1022	Y122CMR	Y1MRTC
YSR28FX26FXLTCKITC	1	1.36	Purple 15	X28RT (3) W28RT (2) W28VT (2)	X28RT (3) W28RT (2)* W28VT (2)*	1 CRIMP	2 CRIMPS	-	-	-
	2	1.19	Black 13	X26RT (2) W26RT (2) W26VT (2)	X26RT (2) W26RT (2)* W26VT (2)*	1 CRIMP	2 CRIMPS	-	-	-
YSR28FX25FXLTCKITC	1	1.36	Purple 15	X28RT (3) W28RT (2) W28VT (2)	X28RT (3) W28RT (2)* W28VT (2)*	1 CRIMP	2 CRIMPS	-	-	-
	2	1.00	Pink 12	X25RT (2) W25RT (2) W25VT (2)	X25RT (2) W25RT (2)* W25VT (2)*	1 CRIMP	2 CRIMPS	-	-	-
YSR28FX2CFXLTCKITC	1	1.36	Purple 15	X28RT (3) W28RT (2) W28VT (2)	X28RT (3) W28RT (2)* W28VT (2)*	1 CRIMP	2 CRIMPS	-	-	-
	2	0.78	Brown 10	X2CRT (1) W2CRT (1) W2CVT (1)	X2CRT (1)	1 CRIMP	1 CRIMP	-	2 CRIMPS	2 CRIMPS
YSR28FX4CFXLTCKITC	1	1.36	Purple 15	X28RT (3) W28RT (2) W28VT (2)	X28RT (3) W28RT (2)* W28VT (2)*	1 CRIMP	2 CRIMPS	-	-	-
	2	0.71	Gray 8	X4CRT (1) W4CRT (1) W4CVT (1)	X4CRT (1)	1 CRIMP	1 CRIMP	-	2 CRIMPS	2 CRIMPS
YSR26FX25FXLTCKITC	1	1.10	Black 13	X26RT (2) W26RT (2) W26VT (2)	X26RT (2) W26RT (2)* W26VT (2)*	1 CRIMP	2 CRIMPS	-	-	-
	2	1.00	Pink 12	X25RT (2) W25RT (2) W25VT (2)	X25RT (2) W25RT (2)* W25VT (2)*	1 CRIMP	2 CRIMPS	-	-	-
YSR26FX2CFXLTCKITC	1	1.10	Black 13	X26RT (2) W26RT (2) W26VT (2)	X26RT (2) W26RT (2)* W26VT (2)*	1 CRIMP	2 CRIMPS	-	-	-
	2	0.78	Brown 10	X2CRT (1) W2CRT (1) W2CVT (1)	X2CRT (1)	1 CRIMP	1 CRIMP	-	2 CRIMPS	2 CRIMPS
YSR26FX4CFXLTCKITC	1	1.10	Black 13	X26RT (2) W26RT (2) W26VT (2)	X26RT (2) W26RT (2)* W26VT (2)*	1 CRIMP	2 CRIMPS	-	-	-
	2	0.71	Gray 8	X4CRT (1) W4CRT (1) W4CVT (1)	X4CRT (1)	1 CRIMP	1 CRIMP	-	2 CRIMPS	2 CRIMPS
YSR26FX6CFXLTCKITC	1	1.10	Black 13	X26RT (2) W26RT (2) W26VT (2)	X26RT (2) W26RT (2)* W26VT (2)*	1 CRIMP	2 CRIMPS	-	-	-
	2	0.70	Blue 7	X5CRT (1) W5CRT (1) W5CVT (1)	X5CRT (1)	1 CRIMP	1 CRIMP	-	1 CRIMP	1 CRIMP

* Not recommended due to handle force required for proper installation.

Compression Connections

Copper — Code / Flex — Reducing Splice Kit
Standard Barrel — with Inspection Window

TYPE YSR-TC (Continued)

MECHANICAL INSTALLATION TOOLING CHART

Standard Barrel with Inspection Window

Kit Catalog Number	Barrel	Strip Length	Color Code & Die Index #	Mechanical & Ratchet Dies Required (# of Crimps)		Mechanical & Ratchet Dedicated Die Tools Number of Crimps				
				MD6 / MD7 Series	OUR840	MY28 / MY29 Series	MRC840	MRE1022B / Y8MRB1 / Y10D / Y1022	Y122CMR	Y1MRTC
YSR25FX2CFXLTKITC	1	1.00	Pink 12	X25RT (2) W25RT (2) W25VT (2)	X25RT (2) W25RT (2)* W25VT (2)*	1 CRIMP	2 CRIMPS	-	-	-
	2	0.76	Brown 10	X2CRT (1) W2CRT (1) W2CVT (1)	X2CRT (1)	1 CRIMP	1 CRIMP	-	2 CRIMPS	2 CRIMPS
YSR25FX4CFXLTKITC	1	1.00	Pink 12	X25RT (2) W25RT (2) W25VT (2)	X25RT (2) W25RT (2)* W25VT (2)*	1 CRIMP	2 CRIMPS	-	-	-
	2	0.62	Gray 8	X4CRT (1) W4CRT (1) W4CVT (1)	X4CRT (1)	1 CRIMP	1 CRIMP	-	2 CRIMPS	2 CRIMPS
YSR25FX6CFXLTKITC	1	1.00	Pink 12	X25RT (2) W25RT (2) W25VT (2)	X25RT (2) W25RT (2)* W25VT (2)*	1 CRIMP	2 CRIMPS	-	-	-
	2	0.61	Blue 7	X5CRT (1) W5CRT (1) W5CVT (1)	X5CRT (1)	1 CRIMP	1 CRIMP	-	1 CRIMP	1 CRIMP
YSR25FX8CFXLTKITC	1	1.01	Pink 12	X25RT (2) W25RT (2) W25VT (2)	X25RT (2) W25RT (2)* W25VT (2)*	1 CRIMP	2 CRIMPS	-	-	-
	2	0.60	Red 49	X8CRT (1) W8CRT (1) W8CVT (1)	X8CRT (1) W8CRT (1) W8CVT (1)	1 CRIMP	1 CRIMP	-	1 CRIMP	1 CRIMP
YSR2CFX4CFXLTKITC	1	0.78	Brown 10	X2CRT (1) W2CRT (1) W2CVT (1)	X2CRT (1)	1 CRIMP	1 CRIMP	-	2 CRIMPS	2 CRIMPS
	2	0.63	Gray 8	X4CRT (1) W4CRT (1) W4CVT (1)	X4CRT (1)	1 CRIMP	1 CRIMP	-	2 CRIMPS	2 CRIMPS
YSR2CFX6CFXLTKITC	1	0.78	Brown 10	X2CRT (1) W2CRT (1) W2CVT (1)	X2CRT (1)	1 CRIMP	1 CRIMP	-	2 CRIMPS	2 CRIMPS
	2	0.61	Blue 7	X5CRT (1) W5CRT (1) W5CVT (1)	X5CRT (1)	1 CRIMP	1 CRIMP	-	1 CRIMP	1 CRIMP
YSR2CFX8CFXLTKITC	1	0.78	Brown 10	X2CRT (1) W2CRT (1) W2CVT (1)	X2CRT (1)	1 CRIMP	1 CRIMP	-	2 CRIMPS	2 CRIMPS
	2	0.60	Red 49	X8CRT (1) W8CRT (1) W8CVT (1)	X8CRT (1) W8CRT (1) W8CVT (1)	1 CRIMP	1 CRIMP	-	1 CRIMP	1 CRIMP
YSR4CFX6CFXLTKITC	1	0.71	Gray 8	X4CRT (1) W4CRT (1) W4CVT (1)	X4CRT (1)	1 CRIMP	1 CRIMP	-	2 CRIMPS	2 CRIMPS
	2	0.61	Blue 7	X5CRT (1) W5CRT (1) W5CVT (1)	X5CRT (1)	1 CRIMP	1 CRIMP	-	1 CRIMP	1 CRIMP

* Not recommended due to handle force required for proper installation.

TYPE YSR-TC (Continued)

MECHANICAL INSTALLATION TOOLING CHART

Standard Barrel with Inspection Window

Kit Catalog Number	Barrel	Strip Length	Color Code & Die Index #	Mechanical & Ratchet Dies Required (# of Crimps)		Mechanical & Ratchet Dedicated Die Tools Number of Crimps				
				MD6 / MD7 Series	OUR840	MY28 / MY29 Series	MRC840	MRE1022B / Y8MRB1 / Y10D / Y1022	Y122CMR	Y1MRTC
YSR4CFX8CFXLTKITC	1	0.71	Gray 8	X4CRT (1) W4CRT (1) W4CVT (1)	X4CRT (1)	1 CRIMP	1 CRIMP	-	2 CRIMPS	2 CRIMPS
	2	0.60	Red 49	X8CRT (1) W8CRT (1) W8CVT (1)	X8CRT (1) W8CRT (1) W8CVT (1)	1 CRIMP	1 CRIMP	-	1 CRIMP	1 CRIMP
YSR4CFX10CLTKITC	1	0.71	Gray 8	X4CRT (1) W4CRT (1) W4CVT (1)	X4CRT (1)	1 CRIMP	1 CRIMP	-	2 CRIMPS	2 CRIMPS
	2	0.65	-	-	-	-	-	1 CRIMP	1 CRIMP	-
YSR6CFX8CFXLTKITC	1	0.70	Blue 7	X5CRT (1) W5CRT (1) W5CVT (1)	X5CRT (1)	1 CRIMP	1 CRIMP	-	1 CRIMP	1 CRIMP
	2	0.57	Red 49	X8CRT (1) W8CRT (1) W8CVT (1)	X8CRT (1) W8CRT (1) W8CVT (1)	1 CRIMP	1 CRIMP	-	1 CRIMP	1 CRIMP
YSR6CFX10CLTKITC	1	0.70	Blue 7	X5CRT (1) W5CRT (1) W5CVT (1)	X5CRT (1)	1 CRIMP	1 CRIMP	-	1 CRIMP	1 CRIMP
	2	0.63	-	-	-	-	-	1 CRIMP	1 CRIMP	-
YSR6CFX14CLTKITC	1	0.70	Blue 7	X5CRT (1) W5CRT (1) W5CVT (1)	X5CRT (1)	1 CRIMP	1 CRIMP	-	1 CRIMP	1 CRIMP
	2	0.63	-	-	-	-	-	2 CRIMPS	-	-
YSR8CFX10CLTKITC	1	0.57	Red 49	X8CRT (1) W8CRT (1) W8CVT (1)	X8CRT (1) W8CRT (1) W8CVT (1)	1 CRIMP	1 CRIMP	-	1 CRIMP	1 CRIMP
	2	0.63	-	-	-	-	-	1 CRIMP	1 CRIMP	-
YSR8CFX14CLTKITC	1	0.57	Red 49	X8CRT (1) W8CRT (1) W8CVT (1)	X8CRT (1) W8CRT (1) W8CVT (1)	1 CRIMP	1 CRIMP	-	1 CRIMP	1 CRIMP
	2	0.63	-	-	-	-	-	2 CRIMPS	-	-
YSR10CFX12CLTKITC	1	0.63	-	-	-	-	-	1 CRIMP	1 CRIMP	-
	2	0.63	-	-	-	-	-	2 CRIMPS	-	-
YSR10CFX14CLTKITC	1	0.63	-	-	-	-	-	1 CRIMP	1 CRIMP	-
	2	0.63	-	-	-	-	-	2 CRIMPS	-	-

* Not recommended due to handle force required for proper installation.

TYPE YSR-TC

HYREDUCER™ In-Line Long Barrel Reducer Splice Kits for Telecommunications Applications with Inspection Window

Type YSR-TC reducing splice kits provide for splicing two different cable sizes with inspection holes. The larger conductor is inserted first and butts against the center of the connector where the smaller barrel begins. Constructed from seamless, high conductivity electrolytic copper tubing for maximum conductivity and tin plated to resist corrosion. The YSR-TC family also features the BURNDY® color code system.

Features & Benefits

- Each splice kit includes one YSR-TC compression in-line splice reducer connector and heat shrink
- The YSR-TC type reducing compression splice connector provided in the kit is UL Listed in accordance with UL 486A-486B - Wire Connectors; UL Listed 90°C up to 35kV
- Barrels have 2 inspection windows on each side to allow for visual verification that the wire has been fully inserted prior to crimping the splice
- Designed configurations allow for copper code-to-code wire connections, copper code-to-flex wire connections, and copper flex-to-flex wire connections; see table for more complete details
- Barrel is designed with a taper to accommodate a main run wire that is reduced to a smaller tap wire
- Barrel also provided with an internal chamfer at the wire entry to ensure smooth insertion of the wire, preventing possible damaging of the wire strands during insertion
- Electro-tin plated unless otherwise specified to reduce galvanic corrosion (bimetallic) and resist corrosive elements
- Long barrel allows for an increased number of crimps which will increase the mechanical strength of the connection
- Connectors clearly marked with color coding
- Can be used in place of H-taps; the in-line design saves space in cable trays and other similar applications

Accessories

- Hardware - Section F
- PENETROX™ Oxide Inhibitor - Section F
- Heat and Cold Shrink Tubing - Section D
- WIREMIKE™ Wire Micrometer - Section F
- Wire Management (Cable Ties) - Section G

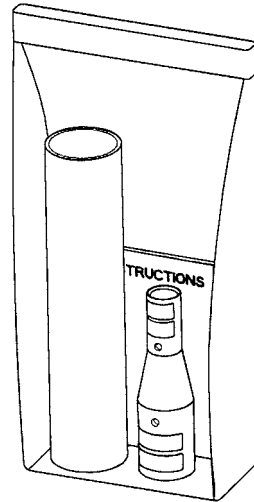

Connector with Clear Heat Shrink Kit

Clear heat shrink UL224 VW1 Listed. Passes TELCORDIA GR-347-CORE Abrasion and Cut Test up to 750 kcmil Class B code cable; contact factory for 750 flex cable applications.

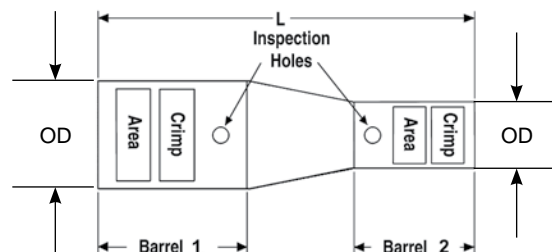

TYPE YSR-TC (Continued)

HYREDUCER™ In-Line Long Barrel Reducer Splice Kits with Inspection Window

Connector with Clear Heat Shrink Kit

Clear heat shrink UL224 VW1 Listed. Passes TELCORDIA GR-347-CORE Abrasion and Cut Test up to 750 kcmil Class B code cable; contact factory for 750 flex cable applications.

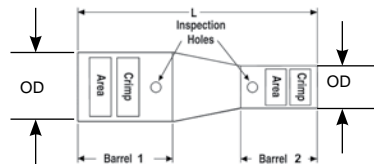

Kit Catalog Number	Overall Length (L)	Barrel 1					Barrel 2				
		Copper Wire Size		Dimensions		Color Code & Die Index #	Copper Wire Size		Dimensions		Color Code & Die Index #
		Conductor	MM ²	Outside Diameter (OD)	Barrel Length (B)		Conductor	MM ²	Outside Diameter (OD)	Barrel Length (B)	
YSR44FX39TCKITC	6.69	750 KCMIL G,H 777 DLO	500 MM ² Class 5	1.49	3.35	Yellow L115	750 KCMIL B,C	-	1.30	2.82	Black 24
YSR44FX34TCKITC	7.23	750 KCMIL G,H 777 DLO	500 MM ² Class 5	1.49	3.35	Yellow L115	500 KCMIL B,C	240 MM ² Class 2	1.06	2.75	Brown 20
YSR44FX31TCKITC	7.47	750 KCMIL G,H 777 DLO	500 MM ² Class 5	1.49	3.35	Yellow L115	350 KCMIL B,C	185 MM ² Class 2	0.88	2.51	Red 18
YSR3931TCKITC	6.43	750 KCMIL B,C	-	1.30	2.82	Black 24	350 KCMIL B,C	185 MM ² Class 2	0.88	2.51	Red 18
YSR3928TCKITC	6.51	750 KCMIL B,C	-	1.30	2.82	Black 24	4/0 AWG B,C	-	0.69	2.11	Purple 15
YSR38FX31TCKITC	6.51	500 KCMIL H,I,K 550 KCMIL G,H,I 535 DLO	300 MM ² Class 5	1.25	3.03	Pink L99	350 KCMIL B,C	185 MM ² Class 2	0.88	2.51	Red 18
YSR38FX28TCKITC	6.59	500 KCMIL H,I,K 550 KCMIL G,H,I 535 DLO	300 MM ² Class 5	1.25	3.03	Pink L99	4/0 AWG B,C	-	0.69	2.11	Purple 15
YSR3431TCKITC	5.74	500 KCMIL B,C	240 MM ² Class 2	1.06	2.75	Brown 20	350 KCMIL B,C	185 MM ² Class 2	0.88	2.51	Red 18
YSR3428TCKITC	5.82	500 KCMIL B,C	240 MM ² Class 2	1.06	2.75	Brown 20	4/0 AWG B,C	-	0.69	2.11	Purple 15
YSR3425FXTCKITC	5.69	500 KCMIL B,C	240 MM ² Class 2	1.06	2.75	Brown 20	1/0 AWG B,C,G,H,I,K,M DLO	50 MM ² Class 5	0.56	1.66	Pink 12
YSR34FX28TCKITC	5.82	350 KCMIL G,H,I,K,M 373 DLO	240 MM ² Class 5	1.06	2.75	Blue 19	4/0 AWG B,C	-	0.69	2.11	Purple 15
YSR34FX28FXTCKITC	5.83	350 KCMIL G,H,I,K,M 373 DLO	240 MM ² Class 5	1.06	2.75	Blue 19	4/0 AWG B,C,G,H,I,K,M DLO	120 MM ² Class 5	0.77	2.34	Purple 15
YSR34FX25FXTCKITC	5.69	350 KCMIL G,H,I,K,M 373 DLO	240 MM ² Class 5	1.06	2.75	Blue 19	1/0 AWG B,C,G,H,I,K,M DLO	50 MM ² Class 5	0.56	1.66	Pink 12
YSR3128TCKITC	5.10	350 KCMIL B,C	185 MM ² Class 2	0.88	2.51	Red 18	4/0 AWG B,C	-	0.69	2.11	Purple 15

Separate Installation Tooling Chart follows.

Compression Connections

Copper — Code / Flex — Reducing Splice Kit
Long Barrel — with Inspection Window

TYPE YSR-TC (Continued)

HYREDUCER™ In-Line Long Barrel Reducer
Splice Kits with Inspection Window

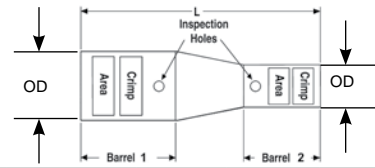

Kit Catalog Number	Overall Length (L)	Barrel 1					Barrel 2				
		Copper Wire Size		Dimensions		Color Code & Die Index #	Copper Wire Size		Dimensions		Color Code & Die Index #
		Conductor	MM ²	Outside Diameter (OD)	Barrel Length (B)		Conductor	MM ²	Outside Diameter (OD)	Barrel Length (B)	
YSR3125FXTCKITC	4.97	350 KCMIL B,C	185 MM ² Class 2	0.88	2.51	Red 18	1/0 AWG B,C,G,H,I,K,M DLO	50 MM ² Class 5	0.56	1.66	Pink 12
YSR312CFXTCKITC	4.91	350 KCMIL B,C	185 MM ² Class 2	0.88	2.51	Red 18	#2 AWG B,C,G,H,I,K,M DLO	35 MM ² Class 5	0.46	1.33	Brown 10
YSR32FX29FXTCKITC	5.30	300 KCMIL G,H,I,K,M DLO	185 MM ² Class 5	0.95	2.48	Red 18	250 KCMIL B,C 4/0 AWG G,H,I,K,M DLO	120 MM ² Class 5	0.86	2.34	Yellow 16
YSR32FX28FXTCKITC	5.28	300 KCMIL G,H,I,K,M DLO	185 MM ² Class 5	0.95	2.48	Red 18	4/0 AWG B,C,G,H,I,K,M DLO	120 MM ² Class 5	0.77	2.34	Purple 15
YSR29FX25FXTCKITC	4.63	250 KCMIL B,C 4/0 AWG G,H,I,K,M DLO	120 MM ² Class 5	0.86	2.36	Yellow 16	1/0 AWG B,C,G,H,I,K,M DLO	50 MM ² Class 5	0.56	1.66	Pink 12
YSR29FX2CFXTCKITC	4.56	250 KCMIL B,C 4/0 AWG G,H,I,K,M DLO	120 MM ² Class 5	0.86	2.36	Yellow 16	#2 AWG B,C,G,H,I,K,M DLO	35 MM ² Class 5	0.46	1.33	Brown 10
YSR2825FXTCKITC	4.09	4/0 AWG B,C	-	0.69	2.11	Purple 15	1/0 AWG B,C,G,H,I,K,M DLO	50 MM ² Class 5	0.56	1.66	Pink 12
YSR282CFXTCKITC	4.03	4/0 AWG B,C	-	0.69	2.11	Purple 15	#2 AWG B,C,G,H,I,K,M DLO	35 MM ² Class 5	0.46	1.33	Brown 10
YSR286CFXTCKITC	4.25	4/0 AWG B,C	-	0.69	2.11	Purple 15	#6 AWG B,C,G,H,I,K,M DLO	16 MM ² Class 5	0.31	1.27	Blue 7
YSR26FX6CFXTCKITC	3.86	2/0 AWG B,C,G,H,I,K,M DLO	70 MM ² Class 5	0.63	1.85	Black 13	#6 AWG B,C,G,H,I,K,M DLO	16 MM ² Class 5	0.31	1.27	Blue 7
YSR25FX6CFXTCKITC	3.48	1/0 AWG B,C,G,H,I,K,M DLO	50 MM ² Class 5	0.56	1.66	Pink 12	#6 AWG B,C,G,H,I,K,M DLO	16 MM ² Class 5	0.31	1.27	Blue 7
YSR2CFX6CFXTCKITC	2.88	#2 AWG B,C,G,H,I,K,M DLO	35 MM ² Class 5	0.46	1.33	Brown 10	#6 AWG B,C,G,H,I,K,M DLO	16 MM ² Class 5	0.31	1.27	Blue 7
YSR4CFX6CFXTCKITC	2.49	#4 AWG B,C,G,H,I,K,M DLO	-	0.38	1.15	Gray 8	#6 AWG B,C,G,H,I,K,M DLO	16 MM ² Class 5	0.31	1.27	Blue 7

Separate Installation Tooling Chart follows.

TYPE YSR-TC (Continued)

HYDRAULIC INSTALLATION TOOLING CHART

Long Barrel with Inspection Window

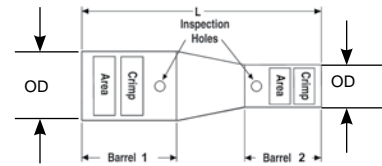

Kit Catalog Number	Barrel	Strip Length	Color Code & Die Index #	Hydraulic Tools Dies Required (# of Crimps)					Hydraulic Dieless Tools Number of Crimps	
				PATMD / 600 / 500 Series	750 / 35 Series	45 Series Use PT6515 with U Dies	46 Series Use PUADP1 with U Dies	60 Series	81K / 81K2 / 4PC Series	644 / 444S Series
YSR44FX39TCKITC	1	3.09	Yellow L115	-	U44XRT (4)	U44XRT (4)	U44XRT (4) P44XRT (4)	L44RT (2)	3 CRIMPS	1 CRIMP
	2	2.71	Black 24	-	U39RT (4)	U39RT (4)	U39RT (4) P39RT (4)	L39RT (2)	4 CRIMPS	1 CRIMP
YSR44FX34TCKITC	1	3.09	Yellow L115	-	U44XRT (4)	U44XRT (4)	U44XRT (4) P44XRT (4)	L44RT (2)	3 CRIMPS	1 CRIMP
	2	2.66	Brown 20	W34RT (4) W34VT (4)	U34RT (4)	U34RT (4)	U34RT (4)	L34RT (2)	4 OVERLAPPING CRIMPS	1 CRIMP
YSR44FX31TCKITC	1	3.09	Yellow L115	-	U44XRT (4)	U44XRT (4)	U44XRT (4) P44XRT (4)	L44RT (2)	3 CRIMPS	1 CRIMP
	2	2.42	Red 18	W31RT (4) W31VT (4)	U31RT (4)	U31RT (4)	U31RT (4)	L31RT (1)	3 OVERLAPPING CRIMPS	1 CRIMP
YSR3931TCKITC	1	2.71	Black 24	-	U39RT (4)	U39RT (4)	U39RT (4) P39RT (4)	L39RT (2)	4 CRIMPS	1 CRIMP
	2	2.42	Red 18	W31RT (4) W31VT (4)	U31RT (4)	U31RT (4)	U31RT (4)	L31RT (1)	3 OVERLAPPING CRIMPS	1 CRIMP
YSR3928TCKITC	1	2.71	Black 24	-	U39RT (4)	U39RT (4)	U39RT (4) P39RT (4)	L39RT (2)	4 CRIMPS	1 CRIMP
	2	2.05	Purple 15	X28RT (6) W28RT (4) W28VT (4)	U28RT (2)	U28RT (2)	U28RT (2)	L28RT (1)	2 CRIMPS	1 CRIMP
YSR38FX31TCKITC	1	2.93	Pink L99	-	U38XRT (4)	U38XRT (4)	U38XRT (4)	L38RT(2)	2 CRIMPS	1 CRIMP
	2	2.47	Red 18	W31RT (4) W31VT (4)	U31RT (4)	U31RT (4)	U31RT (4)	L31RT (1)	3 OVERLAPPING CRIMPS	1 CRIMP
YSR38FX28TCKITC	1	2.93	Pink L99	-	U38XRT (4)	U38XRT (4)	U38XRT (4)	L38RT(2)	2 CRIMPS	1 CRIMP
	2	2.05	Purple 15	X28RT (6) W28RT (4) W28VT (4)	U28RT (2)	U28RT (2)	U28RT (2)	L28RT (1)	2 CRIMPS	1 CRIMP
YSR3431TCKITC	1	2.67	Brown 20	W34RT (4) W34VT (4)	U34RT (4)	U34RT (4)	U34RT (4)	L34RT (2)	4 OVERLAPPING CRIMPS	1 CRIMP
	2	2.42	Red 18	W31RT (4) W31VT (4)	U31RT (4)	U31RT (4)	U31RT (4)	L31RT (1)	3 OVERLAPPING CRIMPS	1 CRIMP
YSR3428TCKITC	1	2.67	Brown 20	W34RT (4) W34VT (4)	U34RT (4)	U34RT (4)	U34RT (4)	L34RT (2)	4 OVERLAPPING CRIMPS	1 CRIMP
	2	2.05	Purple 15	X28RT (6) W28RT (4) W28VT (4)	U28RT (2)	U28RT (2)	U28RT (2)	L28RT (1)	2 CRIMPS	1 CRIMP
YSR3425FXTCKITC	1	2.67	Brown 20	W34RT (4) W34VT (4)	U34RT (4)	U34RT (4)	U34RT (4)	L34RT (2)	4 OVERLAPPING CRIMPS	1 CRIMP
	2	1.68	Pink 12	X25RT (4) W25RT (4) W25VT (4)	U25RT (2)	U25RT (2)	U25RT (2)	-	2 CRIMPS	1 CRIMP

Compression Connections

Copper — Code / Flex — Reducing Splice Kit
Long Barrel — with Inspection Window

TYPE YSR-TC (Continued)

HYDRAULIC INSTALLATION TOOLING CHART Long Barrel with Inspection Window

Kit Catalog Number	Barrel	Strip Length	Color Code & Die Index #	Hydraulic Tools Dies Required (# of Crimps)					Hydraulic Dieless Tools Number of Crimps	
				PATMD / 600 / 500 Series	750 / 35 Series	45 Series Use PT6515 with U Dies	46 Series Use PUADP1 with U Dies	60 Series	81K / 81K2 / 4PC Series	644 / 444S Series
YSR34FX28TCKITC	1	2.67	Blue 19	W32RT (4) W32VT (4)	U32RT (4)	U32RT (4)	U32RT (4)	L34RT (1)	2 CRIMPS	1 CRIMP
	2	2.05	Purple 15	X28RT (6) W28RT (4) W28VT (4)	U28RT (2)	U28RT (2)	U28RT (2)	L28RT (1)	2 CRIMPS	1 CRIMP
YSR34FX28FXTCKITC	1	2.67	Blue 19	W32RT (4) W32VT (4)	U32RT (4)	U32RT (4)	U32RT (4)	L34RT (1)	2 CRIMPS	1 CRIMP
	2	2.27	Purple 15	X28RT (6) W28RT (4) W28VT (4)	U28RT (2)	U28RT (2)	U28RT (2)	L28RT (1)	2 CRIMPS	1 CRIMP
YSR34FX25FXTCKITC	1	2.67	Blue 19	W32RT (4) W32VT (4)	U32RT (4)	U32RT (4)	U32RT (4)	L34RT (1)	2 CRIMPS	1 CRIMP
	2	1.61	Pink 12	X25RT (4) W25RT (4) W25VT (4)	U25RT (2)	U25RT (2)	U25RT (2)	-	2 CRIMPS	1 CRIMP
YSR3128TCKITC	1	2.42	Red 18	W31RT (4) W31VT (4)	U31RT (4)	U31RT (4)	U31RT (4)	L31RT (1)	3 OVERLAPPING CRIMPS	1 CRIMP
	2	2.05	Purple 15	X28RT (6) W28RT (4) W28VT (4)	U28RT (2)	U28RT (2)	U28RT (2)	L28RT (1)	2 CRIMPS	1 CRIMP
YSR3125FXTCKITC	1	2.42	Red 18	W31RT (4) W31VT (4)	U31RT (4)	U31RT (4)	U31RT (4)	L31RT (1)	3 OVERLAPPING CRIMPS	1 CRIMP
	2	1.61	Pink 12	X25RT (4) W25RT (4) W25VT (4)	U25RT (2)	U25RT (2)	U25RT (2)	-	2 CRIMPS	1 CRIMP
YSR312CFXTCKITC	1	2.42	Red 18	W31RT (4) W31VT (4)	U31RT (4)	U31RT (4)	U31RT (4)	L31RT (1)	3 OVERLAPPING CRIMPS	1 CRIMP
	2	1.29	Brown 10	X2CRT (2) W2CRT (2) W2CVT (2)	U2CRT (2)	U2CRT (2)	U2CRT (2)	-	2 CRIMPS	1 CRIMP
YSR32FX29FXTCKITC	1	2.40	Red 18	W31RT (4) W31VT (4)	U31RT (4)	U31RT (4)	U31RT (4)	L32RT (1)	2 CRIMPS	1 CRIMP
	2	2.27	Yellow 16	X29RT (8) W29RT (4) W29VT (4)	U29RT (2)	U29RT (2)	U29RT (2)	L29RT (1)	2 CRIMPS	1 CRIMP
YSR32FX28FXTCKITC	1	2.40	Red 18	W31RT (4) W31VT (4)	U31RT (4)	U31RT (4)	U31RT (4)	L32RT (1)	2 CRIMPS	1 CRIMP
	2	2.27	Purple 15	X28RT (6) W28RT (4) W28VT (4)	U28RT (2)	U28RT (2)	U28RT (2)	L28RT (1)	2 CRIMPS	1 CRIMP
YSR29FX25FXTCKITC	1	2.29	Yellow 16	X29RT (8) W29RT (4) W29VT (4)	U29RT (2)	U29RT (2)	U29RT (2)	L29RT (1)	2 CRIMPS	1 CRIMP
	2	1.61	Pink 12	X25RT (4) W25RT (4) W25VT (4)	U25RT (2)	U25RT (2)	U25RT (2)	-	2 CRIMPS	1 CRIMP

TYPE YSR-TC (Continued)

HYDRAULIC INSTALLATION TOOLING CHART

Long Barrel with Inspection Window

Kit Catalog Number	Barrel	Strip Length	Color Code & Die Index #	Hydraulic Tools Dies Required (# of Crimps)					Hydraulic Dieless Tools Number of Crimps	
				PATMD / 600 / 500 Series	750 / 35 Series	45 Series Use PT6515 with U Dies	46 Series Use PUADP1 with U Dies	60 Series	81K / 81K2 / 4PC Series	644 / 444S Series
YSR29FX2CFXTCKITC	1	2.29	Yellow 16	X29RT (8) W29RT (4) W29VT (4)	U29RT (2)	U29RT (2)	U29RT (2)	L29RT (1)	2 CRIMPS	1 CRIMP
	2	1.29	Brown 10	X2CRT (2) W2CRT (2) W2CVT (2)	U2CRT (2)	U2CRT (2)	U2CRT (2)	-	2 CRIMPS	1 CRIMP
YSR2825FXTKITC	1	2.06	Purple 15	X28RT (6) W28RT (4) W28VT (4)	U28RT (2)	U28RT (2)	U28RT (2)	L28RT (1)	2 CRIMPS	1 CRIMP
	2	1.61	Pink 12	X25RT (4) W25RT (4) W25VT (4)	U25RT (2)	U25RT (2)	U25RT (2)	-	2 CRIMPS	1 CRIMP
YSR282CFXTCKITC	1	2.06	Purple 15	X28RT (6) W28RT (4) W28VT (4)	U28RT (2)	U28RT (2)	U28RT (2)	L28RT (1)	2 CRIMPS	1 CRIMP
	2	1.29	Brown 10	X2CRT (2) W2CRT (2) W2CVT (2)	U2CRT (2)	U2CRT (2)	U2CRT (2)	-	2 CRIMPS	1 CRIMP
YSR286CFXTCKITC	1	2.06	Purple 15	X28RT (6) W28RT (4) W28VT (4)	U28RT (2)	U28RT (2)	U28RT (2)	L28RT (1)	2 CRIMPS	1 CRIMP
	2	1.24	Blue 7	X5CRT (2) W5CRT (2) W5CVT (2)	U5CRT (2)	U5CRT (2)	U5CRT (2)	-	1 CRIMP	-
YSR26FX6CFXTCKITC	1	1.80	Black 13	X26RT (4) W26RT (4) W26VT (4)	U26RT (2)	U26RT (2)	U26RT (2)	-	2 CRIMPS	1 CRIMP
	2	1.24	Blue 7	X5CRT (2) W5CRT (2) W5CVT (2)	U5CRT (2)	U5CRT (2)	U5CRT (2)	-	1 CRIMP	-
YSR25FX6CFXTCKITC	1	1.63	Pink 12	X25RT (4) W25RT (4) W25VT (4)	U25RT (2)	U25RT (2)	U25RT (2)	-	2 CRIMPS	1 CRIMP
	2	1.24	Blue 7	X5CRT (2) W5CRT (2) W5CVT (2)	U5CRT (2)	U5CRT (2)	U5CRT (2)	-	1 CRIMP	-
YSR2CFX6CFXTCKITC	1	1.30	Brown 10	X2CRT (2) W2CRT (2) W2CVT (2)	U2CRT (2)	U2CRT (2)	U2CRT (2)	-	2 CRIMPS	1 CRIMP
	2	1.24	Blue 7	X5CRT (2) W5CRT (2) W5CVT (2)	U5CRT (2)	U5CRT (2)	U5CRT (2)	-	1 CRIMP	-
YSR4CFX6CFXTCKITC	1	1.12	Gray 8	X4CRT (2) W4CRT (2) W4CVT (2)	U4CRT (2)	U4CRT (2)	U4CRT (2)	-	1 CRIMP	-
	2	1.24	Blue 7	X5CRT (2) W5CRT (2) W5CVT (2)	U5CRT (2)	U5CRT (2)	U5CRT (2)	-	1 CRIMP	-

Compression Connections

Copper — Code / Flex — Reducing Splice Kit
Long Barrel — with Inspection Window

TYPE YSR-TC (Continued)

MECHANICAL INSTALLATION TOOLING CHART

Long Barrel with Inspection Window

Kit Catalog Number	Barrel	Strip Length	Color Code & Die Index #	Mechanical & Ratchet Dies Required (# of Crimps)		Mechanical & Ratchet Dedicated Die Tools Number of Crimps				
				MD6 / MD7 Series	OUR840	MY28 / MY29 Series	MRC840	MRE1022B / Y8MRB1 / Y10D / Y1022	Y122CMR	Y1MRTC
YSR44FX39TCKITC	1	3.09	Yellow L115	-	-	-	-	-	-	-
	2	2.71	Black 24	-	-	-	-	-	-	-
YSR44FX34TCKITC	1	3.09	Yellow L115	-	-	-	-	-	-	-
	2	2.66	Brown 20	W34RT (4)* W34VT (4)	-	-	-	-	-	-
YSR44FX31TCKITC	1	3.09	Yellow L115	-	-	-	-	-	-	-
	2	2.42	Red 18	W31RT (4)* W31VT (4)	-	-	-	-	-	-
YSR3931TCKITC	1	2.71	Black 24	-	-	-	-	-	-	-
	2	2.42	Red 18	W31RT (4)* W31VT (4)	-	-	-	-	-	-
YSR3928TCKITC	1	2.71	Black 24	-	-	-	-	-	-	-
	2	2.05	Purple 15	X28RT (6) W28RT (4) W28VT (4)	X28RT (6) W28RT (4)* W28VT (4)*	2 CRIMPS	4 CRIMPS	-	-	-
YSR38FX31TCKITC	1	2.93	Pink L99	-	-	-	-	-	-	-
	2	2.47	Red 18	W31RT (4)* W31VT (4)	-	-	-	-	-	-
YSR38FX28TCKITC	1	2.93	Pink L99	-	-	-	-	-	-	-
	2	2.05	Purple 15	X28RT (6) W28RT (4) W28VT (4)	X28RT (6) W28RT (4)* W28VT (4)*	2 CRIMPS	4 CRIMPS	-	-	-
YSR3431TCKITC	1	2.67	Brown 20	W34RT (4)* W34VT (4)	-	-	-	-	-	-
	2	2.42	Red 18	W31RT (4)* W31VT (4)	-	-	-	-	-	-
YSR3428TCKITC	1	2.67	Brown 20	W34RT (4)* W34VT (4)	-	-	-	-	-	-
	2	2.05	Purple 15	X28RT (6) W28RT (4) W28VT (4)	X28RT (6) W28RT (4)* W28VT (4)*	2 CRIMPS	4 CRIMPS	-	-	-
YSR3425FXTCKITC	1	2.67	Brown 20	W34RT (4)* W34VT (4)	-	-	-	-	-	-
	2	1.68	Pink 12	X25RT (4) W25RT (4) W25VT (4)	X25RT (4) W25VT (4)*	2 CRIMPS	4 CRIMPS	-	-	-
YSR34FX28TCKITC	1	2.67	Blue 19	W32VT (4)	-	-	-	-	-	-
	2	2.05	Purple 15	X28RT (6) W28RT (4) W28VT (4)	X28RT (6) W28RT (4)* W28VT (4)*	2 CRIMPS	4 CRIMPS	-	-	-
YSR34FX28FXTCKITC	1	2.67	Blue 19	W32VT (4)	-	-	-	-	-	-
	2	2.27	Purple 15	X28RT (6) W28RT (4) W28VT (4)	X28RT (6) W28VT (4)*	2 CRIMPS	4 CRIMPS	-	-	-

* Not recommended due to handle force required for proper installation.

TYPE YSR-TC (Continued)

MECHANICAL INSTALLATION TOOLING CHART

Long Barrel with Inspection Window

Kit Catalog Number	Barrel	Strip Length	Color Code & Die Index #	Mechanical & Ratchet Dies Required (# of Crimps)		Mechanical & Ratchet Dedicated Die Tools Number of Crimps				
				MD6 / MD7 Series	OUR840	MY28 / MY29 Series	MRC840	MRE1022B / Y8MRB1 / Y10D / Y1022	Y122CMR	Y1MRTC
YSR34FX25FXTCKITC	1	2.67	Blue 19	W32VT (4)	-	-	-	-	-	-
	2	1.61	Pink 12	X25RT (4) W25RT (4) W25VT (4)	X25RT (4) W25VT (4)*	2 CRIMPS	4 CRIMPS	-	-	-
YSR3128TCKITC	1	2.42	Red 18	W31RT (4)* W31VT (4)	-	-	-	-	-	-
	2	2.05	Purple 15	X28RT (6) W28RT (4) W28VT (4)	X28RT (6) W28RT (4)* W28VT (4)*	2 CRIMPS	4 CRIMPS	-	-	-
YSR3125FXTCKITC	1	2.42	Red 18	W31RT (4)* W31VT (4)	-	-	-	-	-	-
	2	1.61	Pink 12	X25RT (4) W25RT (4) W25VT (4)	X25RT (4) W25VT (4)*	2 CRIMPS	4 CRIMPS	-	-	-
YSR312CFXTCKITC	1	2.42	Red 18	W31RT (4)* W31VT (4)	-	-	-	-	-	-
	2	1.29	Brown 10	X2CRT (2) W2CRT (2) W2CVT (2)	X2CRT (2)	2 CRIMPS	2 CRIMPS	-	4 CRIMPS	4 CRIMPS
YSR32FX29FXTCKITC	1	2.40	Red 18	W31VT (4)	-	-	-	-	-	-
	2	2.27	Yellow 16	X29RT (8) W29RT (4) W29VT (4)	X29RT (8) W29VT (4)*	2 CRIMPS	-	-	-	-
YSR32FX28FXTCKITC	1	2.40	Red 18	W31VT (4)	-	-	-	-	-	-
	2	2.27	Purple 15	X28RT (6) W28RT (4) W28VT (4)	X28RT (6) W28VT (4)*	2 CRIMPS	4 CRIMPS	-	-	-
YSR29FX25FXTCKITC	1	2.29	Yellow 16	X29RT (8) W29RT (4) W29VT (4)	X29RT (8) W29VT (4)*	2 CRIMPS	-	-	-	-
	2	1.61	Pink 12	X25RT (4) W25RT (4) W25VT (4)	X25RT (4) W25VT (4)*	2 CRIMPS	4 CRIMPS	-	-	-
YSR29FX2CFXTCKITC	1	2.29	Yellow 16	X29RT (8) W29RT (4) W29VT (4)	X29RT (8) W29VT (4)*	2 CRIMPS	-	-	-	-
	2	1.29	Brown 10	X2CRT (2) W2CRT (2) W2CVT (2)	X2CRT (2)	2 CRIMPS	2 CRIMPS	-	4 CRIMPS	4 CRIMPS
YSR2825FXTCKITC	1	2.06	Purple 15	X28RT (6) W28RT (4) W28VT (4)	X28RT (6) W28RT (4)* W28VT (4)*	2 CRIMPS	4 CRIMPS	-	-	-
	2	1.61	Pink 12	X25RT (4) W25RT (4) W25VT (4)	X25RT (4) W25VT (4)*	2 CRIMPS	4 CRIMPS	-	-	-

* Not recommended due to handle force required for proper installation.

TYPE YSR-TC (Continued)

MECHANICAL INSTALLATION TOOLING CHART

Long Barrel with Inspection Window

Kit Catalog Number	Barrel	Strip Length	Color Code & Die Index #	Mechanical & Ratchet Dies Required (# of Crimps)		Mechanical & Ratchet Dedicated Die Tools Number of Crimps				
				MD6 / MD7 Series	OUR840	MY28 / MY29 Series	MRC840	MRE1022B / Y8MRB1 / Y10D / Y1022	Y122CMR	Y1MRTC
YSR282CFXTCKITC	1	2.06	Purple 15	X28RT (6) W28RT (4) W28VT (4)	X28RT (6) W28RT (4)* W28VT (4)*	2 CRIMPS	4 CRIMPS	-	-	-
	2	1.29	Brown 10	X2CRT (2) W2CRT (2) W2CVT (2)	X2CRT (2)	2 CRIMPS	2 CRIMPS	-	4 CRIMPS	4 CRIMPS
YSR286CFXTCKITC	1	2.06	Purple 15	X28RT (6) W28RT (4) W28VT (4)	X28RT (6) W28RT (4)* W28VT (4)*	2 CRIMPS	4 CRIMPS	-	-	-
	2	1.24	Blue 7	X5CRT (2) W5CRT (2) W5CVT (2)	X5CRT (2)	2 CRIMPS	2 CRIMPS	-	1 CRIMP	1 CRIMP
YSR26FX6CFXTCKITC	1	1.80	Black 13	X26RT (4) W26RT (4) W26VT (4)	X26RT (4) W26VT (4)*	2 CRIMPS	4 CRIMPS	-	-	-
	2	1.24	Blue 7	X5CRT (2) W5CRT (2) W5CVT (2)	X5CRT (2)	2 CRIMPS	2 CRIMPS	-	1 CRIMP	1 CRIMP
YSR25FX6CFXTCKITC	1	1.63	Pink 12	X25RT (4) W25RT (4) W25VT (4)	X25RT (4) W25VT (4)*	2 CRIMPS	4 CRIMPS	-	-	-
	2	1.24	Blue 7	X5CRT (2) W5CRT (2) W5CVT (2)	X5CRT (2)	2 CRIMPS	2 CRIMPS	-	1 CRIMP	1 CRIMP
YSR2CFX6CFXTCKITC	1	1.30	Brown 10	X2CRT (2) W2CRT (2) W2CVT (2)	X2CRT (2)	2 CRIMPS	2 CRIMPS	-	4 CRIMPS	4 CRIMPS
	2	1.24	Blue 7	X5CRT (2) W5CRT (2) W5CVT (2)	X5CRT (2)	2 CRIMPS	2 CRIMPS	-	1 CRIMP	1 CRIMP
YSR4CFX6CFXTCKITC	1	1.12	Gray 8	X4CRT (2) W4CRT (2) W4CVT (2)	X4CRT (2)	2 CRIMPS	2 CRIMPS	-	4 CRIMPS	4 CRIMPS
	2	1.24	Blue 7	X5CRT (2) W5CRT (2) W5CVT (2)	X5CRT (2)	2 CRIMPS	2 CRIMPS	-	1 CRIMP	1 CRIMP

* Not recommended due to handle force required for proper installation.

TYPE YRB

HYREDUCER™ Aluminum Reducing Splice



UL Listed 90° C, Up to 35 kV ♦

HYREDUCER™ Type YRB reducer butt splices are designed to splice two different conductor sizes and is UL Listed for aluminum to copper and aluminum to aluminum applications. The outside diameter is held constant to minimize installation dies and is factory pre-filled with PENETROX™ oxide inhibitor.

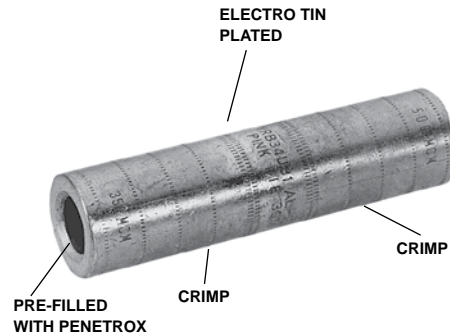

Features & Benefits

- Aluminum splice reducers are dual rated to accommodate both copper and aluminum wire and are indicated with AL-CU on the connector:
 - AL9CU indicates the terminal can accommodate aluminum and copper wire and is UL Listed 90°C, up to 35kV
 - AL7CU indicates the terminal can accommodate aluminum and copper wire and is UL Listed 75°C, up to 35kV
- Barrel features an internal chamfer at the wire entry to ensure smooth insertion of the wire, preventing possible damaging of the wire strands during insertion
- Electro-tin plated unless otherwise specified to reduce galvanic corrosion (bimetallic) and resist corrosive elements
- Connectors are clearly marked with crimp location bands
- Factory pre-filled with PENETROX™ Type A13 oxide inhibitor
- Color coded end caps are factory inserted in the barrels to match the die color code and prevent foreign materials from entering the barrel
- The barrels are designed to accommodate larger run conductor and smaller tap conductor so the inside diameters on each end of the barrel are different but the outside diameter is held constant minimizing number of installation dies necessary

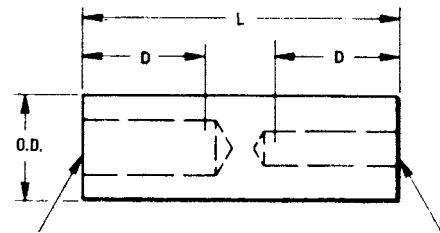

- Aluminum oxidation is not easily detected but causes resistance in a connection; it is imperative the proper preparation takes place prior to making an aluminum-to-aluminum connection
- BURNDY certifies its products using the BURNDY Engineered System and select other crimp tool manufacturers in accordance with one or more of the UL categories in order to obtain a UL Listing

Catalog Number	Conductor Range • Aluminum or Copper Size †		Dimensions			Installation Tooling ▲ Hydraulic Tools, Die Sets (No. of Crimps ‡)				Wire Strip Length
	Barrel A	Barrel B	O.D.	D	L	35 ■, 750, 46* Series	‡	Die Index	Color Code	
YRB2U4	1 AWG 2 AWG	4 AWG 3 AWG	0.65	0.88	2.00	U25ART	1	296	Tan	15/16
YRB25U2	1/0 AWG	1 AWG 2 AWG	0.65	0.88	2.00	U25ART	1	296	Tan	15/16
YRB27U25	3/0 AWG	1/0 AWG	0.85	1.36	3.31	U28ART	2	298	White	1-7/16
YRB27U26	3/0 AWG	2/0 AWG	0.85	1.36	3.31	U28ART	2	298	White	1-7/16
YRB28U26	4/0 AWG	2/0 AWG	0.85	1.36	3.31	U28ART	2	298	White	1-7/16
YRB29U28	250 kcmil	4/0 AWG	1.11	1.73	4.21	U31ART	2	299	Brown	1-13/16
YRB31U28	350 kcmil	4/0 AWG	1.11	1.73	4.21	U31ART	2	299	Brown	1-13/16
YRB31U29	350 kcmil	250 kcmil	1.11	1.73	4.21	U31ART	2	299	Brown	1-13/16
YRB34U31	500 kcmil	350 kcmil	1.31	2.11	5.12	U34ART	4	300	Pink	2-3/16
YRB36U31	600 kcmil	350 kcmil	1.46	2.25	5.57	U39ART2	4	936	Yellow	2-5/16
YRB36U34	600 kcmil	500 kcmil	1.46	2.25	5.57	U39ART2	4	936	Yellow	2-5/16
YRB39U34	700/750 kcmil • 900 Compact AL ▼	500 kcmil	1.46	2.25	5.57	U39ART2	4	936	Yellow	2-5/16
YRB39U36	700/750 kcmil • 900 Compact AL ▼	600 kcmil	1.46	2.25	5.57	U39ART2	4	936	Yellow	2-5/16

† Contact BURNDY for conductor sizes not shown

▲ See tooling section of this catalog for complete tool and die listing

‡ Number of crimps

* Use PUADP1 adaptor with U dies in 46 Series

■ The largest size for the 35 Series is 400 kcmil

♦ For applications greater than 2000 Volts consult cable manufacturer for voltage stress relief instructions

• Also accommodates compressed and compact conductors (except for 700 kcmil in 750 kcmil barrel)

▼ Tested with Y644HSXT and PAT644XT-18V dieless tools only and not UL Listed with any tool on 900 Compact Al.

Note: All dimensions shown are for reference only.

TYPE YC-L

Thin Wall Copper C-Tap

UL Listed 90° C, Up to 35 kV ♦

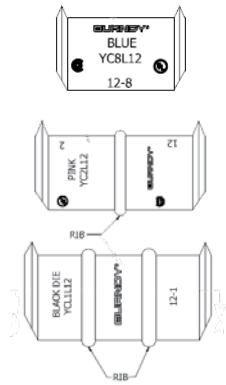

Type YC-L is a thin wall, high conductivity copper connector for making copper taps and parallel connections from #14 to 3/0 AWG.

Features & Benefits

- Material is high conductivity wrought copper providing low resistance for excellent electrical conductivity
- Bare copper ranging taking connector that allows for less inventory
- BURNDY certifies its products using the Burndy Engineered System and select other crimp tool manufacturers in accordance with one or more UL and CSA categories
 - UL Listed UL 486A-486B Wire Connectors
 - UL Listed 467 Grounding and Bonding Equipment (YC3L12 is **not** UL Listed for Grounding and Bonding)
 - CSA C22.2
 - Direct Burial Applications
- Reinforced ribs on the outside of the connector increase the mechanical strength of the connection
- Creates a compact connection that is easy for taping and insulating
- Connectors are clearly marked with color code dot, UL and CSA (when applicable), wire size, die index number and more

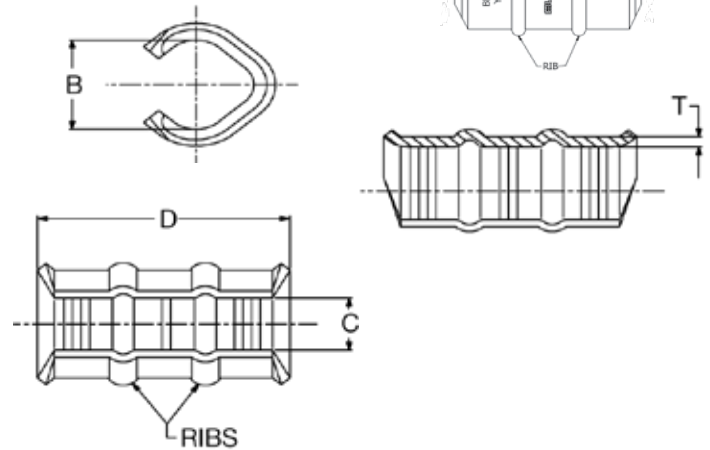

Catalog Number	Copper Conductor AWG Class B, C, Solid ‡		No. of Ribs	Dimensions				Color Code / Die Index	Installation Tooling					Wire Strip Length
									Mechanical		Hydraulic			
									Y122CMR Y1MRTC	MD6, OUR840, MD734R Die No. (# crimps)	MD6, 500 Series (# crimps)	35, 750, 46* Series (# of crimps)	Die ▲ Index Embossment	
Run	Tap	B	C	D	T									
YC8L12	10 8	10 12	0	0.25	0.21	0.60	0.07	Blue 7	1 Crimp	W5CVT (1)	—	—	—	5/8
YC6L12	8 6	10-8 12-10	0	0.33	0.25	0.60	0.07	Gray 8	2 Crimps	W4CVT (1)	—	—	—	5/8
YC4L12	6 5, 4	8-6 12-8	1	0.39	0.28	1.18	0.07	Brown 10	2 Crimps	W2CVT (2)	WC4 (1)	UC4 (1)	10M	1-3/16
YC3L12**	5, 4 3	6-5 12-6	1	0.46	0.27	1.18	0.08	Green 11	—	W1CVT (2)	—	—	—	1-3/16
YC2L12	4 3 2	4 5 12-6	1	0.50	0.36	1.18	0.08	Pink 12	—	W25VT (2)	WC2 (1)	UC2 (1)	12M	1-3/16
YC1L12	3 2 1	4-3 5-4 12-5	2	0.55	0.34	1.75	0.08	Black 13	—	W26VT (3)	WC1 (2)	UC1 (1)	13M	1-13/16
YC25L12	2 1 1/0	3-2 4-3 12-4	2	0.62	0.42	1.75	0.09	Orange 14	—	W27VT (3)	WC25 (2)	UC25 (1)	14M	1-13/16
YC26L12	1 1/0 2/0	2-1 3-2 12-3	2	0.69	0.43	1.75	0.09	Purple 15	—	W28VT (3)	—	—	—	1-13/16
YC27L12	1/0 2/0 3/0	1-1/0 2-1 12-2	2	0.81	0.48	1.75	0.09	Yellow 16	—	W29VT (3)	—	—	—	1-13/16

▲ See tooling section of this catalog for complete tool and die listings.

‡ Refer to website for sales drawing with complete listing with solid/stranded copper conductor

* Use PUADP1 adapter with U dies in 46 Series

For Tin plating add TN suffix (example = YC10L12TN)

Note: All dimensions shown are for reference only.

** YC3L12 is NOT UL Listed or CSA Certified for Grounding and Bonding.

TYPE YCHC

Copper CRIMPIT™ C-Tap

UL Listed 90° C, Up to 35 kV ♦

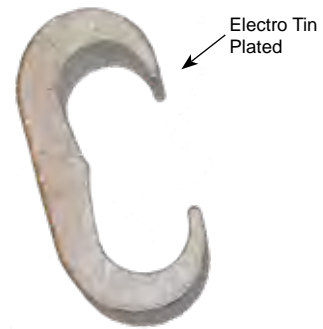

Features & Benefits

- Range taking C-tap that allows for less inventory as one C-tap can accommodate a multitude of wire combinations
- Accommodates a wide range of run/tap combinations
- Manufactured from high conductivity wrought copper providing low resistance for excellent electrical conductivity
- Electro-tin plated unless otherwise specified to reduce galvanic corrosion (bimetallic) and resist corrosive elements
- Each connector has a recommended UL Listed / CSA Certified insulating cover available in both black and clear (see table); clear cover allows for easy inspection of the connection (see separate page for full details on Type CCF-FR and CFR-FR Covers)
- Connectors are clearly marked with stamping
- BURNDY certifies its products using the BURNDY Engineered System and select other crimp tool manufacturers in accordance with one or more of the UL categories in order to obtain a UL Listing

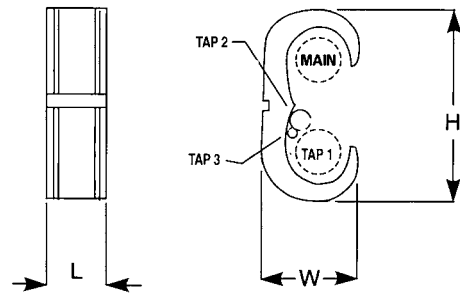

Compression Connections

Copper — Compression
C-Tap

TYPE YCHC (Continued)

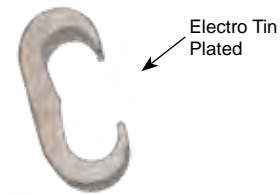

BURNDY Catalog Number	Flame Retardant Cover		Conductor Sizes				▲ Color Code Die Index
	Clear Cat. No.	Black Cat. No. ‡	Main (Run)	Tap 1	Tap 2	Tap 3	
YCHC44TC44	CCFRFR	CFRFR	1000-750 kcmil Class B,C 646-535 kcmil DLO 750-500 kcmil Class I	1000-750 kcmil Class B,C 646-535 kcmil DLO 750-500 kcmil Class I	—	—	White 1102
YCHC39TC39	CCFRFR	CFRFR	750-500 kcmil Class B,C 535-373 kcmil DLO 550-500 kcmil Class I	750-500 kcmil Class B,C 535-373 kcmil DLO 550-500 kcmil Class I	—	—	Blue 1103
YCHC39TC31	CCFRFR	CFRFR	750-500 kcmil Class B,C 535-373 kcmil DLO 550-500 kcmil Class I	350 kcmil-2 AWG Class B,C 4/0-2 AWG Class I, DLO	2-6 AWG Class B,C,Solid 2-8 AWG Class I, DLO	8-14 AWG Class B,C 8-14 AWG Class I, DLO	Blue 1103
YCHC39TC2	CCFRFR	CFRFR	750-500 kcmil Class B,C 535-373 kcmil DLO 550-500 kcmil Class I	2-6 AWG Class B,C,Solid 2-8 Class I, DLO	8-14 AWG Class B,C 8-14 AWG Class I, DLO	—	Blue 1103
YCHC34TC34	CCFNFR	CFNFR	500 kcmil-4/0 AWG Class B,C 373 kcmil-4/0 AWG Class I, DLO	500 kcmil-4/0 AWG Class B,C 373 kcmil-4/0 AWG Class I, DLO	—	—	Brown 1104
YCHC34TC29	CCFNFR	CFNFR	500 kcmil-4/0 AWG Class B,C 373 kcmil-4/0 AWG Class I, DLO	250 kcmil-2 AWG Class B,C 4/0-2 AWG Class I, DLO	2-6 AWG Class B,C,Solid 2-8 AWG Class I, DLO	—	Brown 1104
YCHC34TC2	CCFNFR	CFNFR	500 kcmil-4/0 AWG Class B,C 373 kcmil-4/0 AWG Class I, DLO	2-6 AWG Class B,C,Solid 2-8 Class I, DLO	8-14 AWG Class B,C 8-14 AWG Class I, DLO	—	Brown 1104
YCHC29TC29	CCFDXFR	CFDFR	250 kcmil-2 AWG Class B,C 4/0-2 AWG Class I, DLO	250 kcmil-2 AWG Class B,C 4/0-2 AWG Class I, DLO	—	—	Orange 997
YCHC29TC2	CCFDFR	CFDFR	250 kcmil-2 AWG Class B,C 4/0-2 AWG Class I, DLO	2-6 AWG Class B,C,Solid 2-8 Class I, DLO	8-14 AWG Class B,C 8-14 AWG Class I, DLO	—	Red 251
YCHC2TC2	CCFOFR	CFOFR	2-6 AWG Class B,C,Solid 2-8 Class I, DLO	2-6 AWG Class B,C,Solid 2-8 Class I, DLO	8-14 AWG Class B,C 8-14 AWG Class I, DLO	—	Brown C
YCHC8TC8	◆	◆	8-12 AWG Class B,C 8-12 AWG Class I, DLO	8-12 AWG Class B,C 8-12 AWG Class I, DLO	—	—	Red 240

BURNDY Catalog Number	Flame Retardant Cover		▲ Tooling († No. of Crimps)				H	W	L	Strip Length
	Clear Cat. No.	Black Cat. No. ‡	750, 35 Series	†	46* Series	†				
YCHC44TC44	CCFRFR	CFRFR	—	—	P1102	1	3.59	1.73	1.16	1-1/4"
YCHC39TC39	CCFRFR	CFRFR	—	—	P1103	1	3.12	1.53	1.06	1-1/8"
YCHC39TC31	CCFRFR	CFRFR	—	—	P1103	1	2.96	1.53	1.31	1-3/8"
YCHC39TC2	CCFRFR	CFRFR	—	—	P1103	1	2.66	1.53	1.31	1-3/8"
YCHC34TC34	CCFNFR	CFNFR	U1104	2	U1104	1	2.97	1.38	1.00	1-1/4"
YCHC34TC29	CCFNFR	CFNFR	U1104	2	U1104	1	2.45	1.26	0.88	1"
YCHC34TC2	CCFNFR	CFNFR	U1104	2	U1104	1	2.45	1.26	0.94	1"
YCHC29TC29	CCFDXFR	CFDFR	U997	1	U997	1	2.12	.98	0.94	1"
YCHC29TC2	CCFDFR	CFDFR	U251	1	U251	1	1.78	.97	0.81	1"
YCHC2TC2	CCFOFR	CFOFR	UC	1	UC	1	1.22	.60	0.81	1"
YCHC8TC8	◆	◆	U240	1	U240	1	0.53	.35	0.56	5/8"

Note: To properly use tap 2 and/or tap 3 conductors in YCHC connector a conductor from the tap 1 cable range must be included in the tap 1 groove.

‡ To obtain covers made of polyethylene remove suffix-FR (example: CFO). CFO is not flame retardant.

* Use PUADP1 adaptor with U dies in 46 Series.

▲ See tooling section of Master Catalog for complete tool and die listings.

◆ For applications requiring flame retardant cover, use either a CCFBG-FR (Clear) or CFBG-FR (Black) cover and YH2C2 connector by ordering YH8C8CWCC (Clear) or YH8C8CWC (Black).

Note: All dimensions shown are for reference only.

TYPE YH

H-Tap Copper CRIMPIT™

UL Listed 90° C, Up to 35 kV ♦
UL Listed Grounding and Bonding Equipment*
Direct Burial Rated



Features & Benefits

- Connector: Uninsulated compression H-Tap Connectors
- Connection: Compression connectors are made irreversible and maintenance free
- Applicable Standards: Connectors are only UL Listed and CSA Certified when installed with the BURNDY Engineered System and select other crimp tool manufacturers in accordance with one or more categories
 - Tested in accordance to UL 486A-486B / CSA C22.2 NO 65 Wire Connectors
 - Tested in accordance to UL 467 / CSA C22.2 No 41 Grounding and Bonding Equipment (***YH2929 to YH8C8C ONLY**)
- Temperature and voltage rating: 90°C, up to 35kV; For applications greater than 2000 Volts consult cable manufacturer for voltage stress relief instructions
- Wire Accommodates (see table): H-Tap grooves are designed to accommodate wire ranges
 - Code copper wire (CU): Class B (Concentric, Compressed, Compact) or Class C
 - Flex wire (CU): See table for wire classes
- Connectors are tin-plated
- Connector Design Features:
 - Designs with more than one tap wire groove require installers to utilize a minimum of one Main (Run) and one tap groove; others grooves can be left empty
 - Typical ink markings (as space permits and applicable): Crimp zone indicated by color bands, BURNDY name or logo, UL logo, CSA logo, Wire Size, Die Color Code, Index Number
 - The "third hand" is a string provided with the H-Tap connector used to wrap the wire while being inserted into the run and tap grooves; This feature constrains the wire while the installer applies the recommended number of crimps
- H-Tap connectors can be purchased separately or kitted with covers:
 - YH: H-Tap sold separately without a cover
 - YH-WC: Add "WC" for H-Tap kitted with black cover
 - YH-WCC: Add "WCC" for H-Tap kitted with clear cover

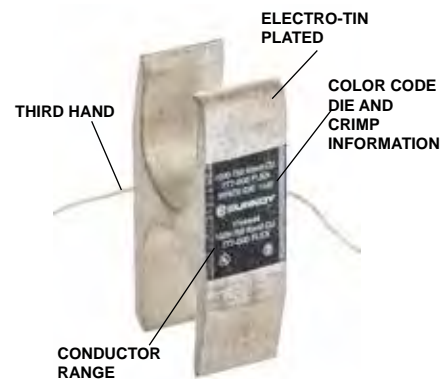

PATENTED

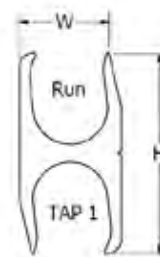

FIG 1

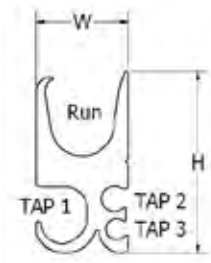

FIG 2

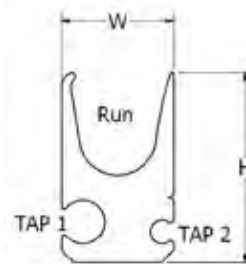

FIG 3

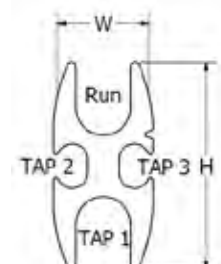

FIG 4

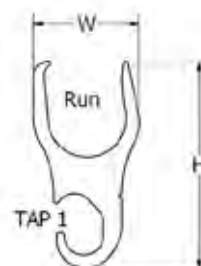

FIG 5

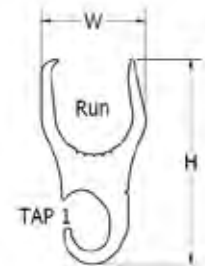

FIG 6

TYPE YH (Continued)

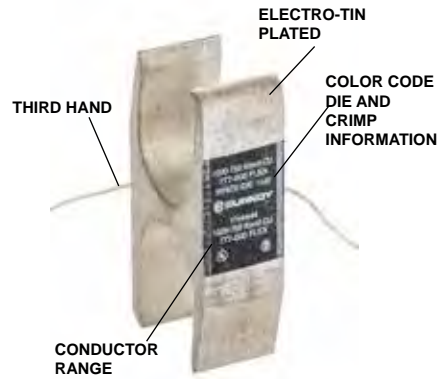

TABLE 1 CODE (Class B,C) & FLEX WIRE (Class G,H,I,K,M,DLO)

H-Tap Connector	Kit Catalog Number		Fig. No.	Conductor Sizes Code (Class B,C) & Flex Wire (Class G,H,I,K,M,DLO)			
	Flame Retardant Cover			Main	Tap 1	Tap 2	Tap 3
	Clear	Black ‡					
YH4444	YH4444WCC	YH4444WC	1	1000-750 kcmil Class B,C 777-535 DLO 750-500 kcmil Class I	1000-750 kcmil Class B,C 777-535 DLO 750-500 kcmil Class I	—	—
YH4434	YH4434WCC*	YH4434WC	6	1000-750 kcmil Class B,C 777-535 DLO 750-500 kcmil Class I	500-350 kcmil Class B,C 350 kcmil Class I,K	—	—
YH4429	YH4429WCC	YH4429WC	5	1000-750 kcmil Class B,C 777-535 DLO 750-500 kcmil Class I	250 kcmil-2 AWG Class B,C 4/0-2 AWG Class I, DLO	—	—
YH3939	YH3939WCC	YH3939WC	1	750-500 kcmil Class B,C 535-444 kcmil DLO 550-450 kcmil Class I	750-350 kcmil Class B,C 535-313 kcmil DLO 550-350 kcmil Class I	—	—
YH3931	YH3931WCC	YH3931WC	2	750-350 kcmil B,C 535 kcmil DLO 550-500 kcmil Class I	4/0-1/0 AWG Class B,C 250 kcmil-1/0 AWG Class I, DLO 4/0 AWG Class K	1-6 AWG Solid 1-6 AWG Class B,C 1-8 AWG Class I, DLO	2-14 AWG Class B,C 2-14 AWG Class I, DLO
YH3434	YH3434WCC	YH3434WC	1	500-250 kcmil Class B,C 373 kcmil-4/0 AWG DLO 350 kcmil-4/0AWG Class I	500 kcmil-4/0 AWG Class B,C 373 kcmil-4/0 AWG DLO 350 kcmil-4/0 AWG Class I	—	—
YH3429	YH3429WCC	YH3429WC	2	500 kcmil-4/0 AWG Class B,C 373 kcmil-4/0 AWG DLO 350 kcmil-4/0 AWG Class I 4/0 AWG Class K	250 kcmil-1/0 AWG Class B,C 4/0-1/0 AWG Class I, DLO 4/0 AWG Class K	1-6 AWG Solid 1-6 AWG Class B,C 1-8 AWG Class I, DLO	8-14 AWG Class B,C 8-14AWG Class I, DLO 8 AWG Class K
YH2929	YH2929WCC	YH2929WC	1	250 kcmil-2 AWG Class B,C 4/0-2 AWG Class I, DLO	250 kcmil-2 AWG Class B,C 4/0-2 AWG Class I, DLO	—	—
YH292C	YH292CWCC	YH292CWC	3	250 kcmil-2 AWG Class B,C 4/0-2 AWG Class I, DLO	2-6 AWG Solid 2-6 AWG Class B,C 2-8 AWG Class I, DLO	8-14 AWG Class B,C 8-14 AWG Class I, DLO	—
YH298C	YH298CWCC	YH298CWC	3	250 kcmil-2 AWG Class B,C 4/0-2 AWG Class I, DLO	8-14 AWG Class B,C 8-14 AWG Class G,H,I, DLO 8 AWG Class K	8-14 AWG Class B,C 8-14 AWG Class G,H,I, DLO 8 AWG Class K	—
YH2C2C	YH2C2CWCC	YH2C2CWC	4	2-6 AWG Solid 2-6 AWG Class B,C 2-6 AWG Class G,H,I, DLO 8 AWG Class I,K, DLO	2-6 AWG Solid 2-6 AWG Class B,C 2-6 AWG Class G,H,I, DLO 8 AWG Class I,K, DLO	8-14 AWG Class B,C 8-14 AWG Class G,H,I, DLO 8 AWG Class K	8-14 AWG Class B,C 8-14 AWG Class G,H,I, DLO 8 AWG Class K
YH6C6C	YH6C6CWCC	YH6C6CWC	1	6-10 AWG Class B,C 6-10 AWG Class I, DLO	6-14 AWG Class B,C 6-14 AWG Class I, DLO	—	—
YH8C8C	YH8C8CWCC	YH8C8CWC	4	8-14 AWG Class B,C 8-14 Class I, DLO	8-14 AWG Class B,C 8-14 AWG Class I, DLO	—	—

• Use PUADP1 adaptor with U dies in 46 Series.

▲ See tooling section of this catalog for complete tool and die listings.

* Not CSA Certified.

Note: All H-Taps ROHS compliant.

Note: All dimensions shown are for reference only.

TYPE YH (Continued)

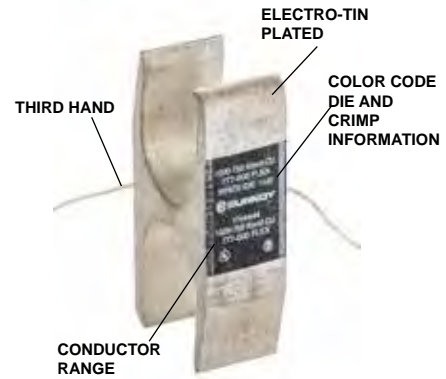

PATENTED

TABLE 2 METRIC CONDUCTOR mm²

H-Tap Connector	Kit Catalog Number		Fig. No.	Metric Conductor Sizes (mm ²)			
	Flame Retardant Cover			Main	Tap 1	Tap 2	Tap 3
	Clear	Black †					
YH4444	YH4444WCC	YH4444WC	1	508-380 mm ² Class 2 393-253 mm ² Class 5	508-380 mm ² Class 2 393-177 mm ² Class 5	—	—
YH4434	YH4434WCC	YH4434WC	6	508-380 mm ² Class 2 393-253 mm ² Class 5	253-177 mm ² Class 2 177 mm ² Class 5	—	—
YH4429	YH4429WCC	YH4429WC	5	508-380 mm ² Class 2 393-253 mm ² Class 5	127-33.6 mm ² Class 2 107-336.6 mm ² Class 5	—	—
YH3939	YH3939WCC	YH3939WC	1	380-253 mm ² Class 2 278-233 mm ² Class 5	380-177 mm ² Class 2 278-159 mm ² Class 5	—	—
YH3931	YH3931WCC	YH3931WC	2	380-177 mm ² Class 2 278-253 mm ² Class 5	107-53.5 mm ² Class 2 127-53.5 mm ² Class 5	42.4-13.3 mm ² Class 1 42.4-13.3 mm ² Class 2 42.4-8.4 mm ² Class 5	33.6-2.1 mm ² Class 2 33.6-2.1 mm ² Class 5
YH3434	YH3434WCC	YH3434WC	1	253-127 mm ² Class 2 189-107 mm ² Class 5	253-127 mm ² Class 2 189-107 mm ² Class 5	—	—
YH3429	YH3429WCC	YH3429WC	2	253-107 mm ² Class 2 189-107 mm ² Class 5	127-33.6 mm ² Class 2 107-336.6 mm ² Class 5	42.4-13.3 mm ² Class 1 42.4-13.3 mm ² Class 2 42.4-8.4 mm ² Class 5	8.4-2.1 mm ² Class 2 8.4-2.1 mm ² Class 5
YH2929	YH2929WCC	YH2929WC	1	127-33.6 mm ² Class 2 107-33.6 mm ² Class 5	127-33.6 mm ² Class 2 107-336.6 mm ² Class 5	—	—
YH292C	YH292CWCC	YH292CWC	3	127-33.6 mm ² Class 2 107-33.6 mm ² Class 5	33.6-13.3 mm ² Class 1 33.6-13.3 mm ² Class 2 33.6-8.4 mm ² Class 5	8.4-2.1 mm ² Class 2 8.4-2.1 mm ² Class 5	—
YH298C	YH298CWCC	YH298CWC	3	127-33.6 mm ² Class 2 107-33.6 mm ² Class 5	13.3-5.3 mm ² Class 2 13.3-5.3 mm ² Class 5	8.4-2.1 mm ² Class 2 8.4-2.1 mm ² Class 5	—
YH2C2C	YH2C2CWCC	YH2C2CWC	4	33.6-13.3 mm ² Class 1 33.6-13.3 mm ² Class 2 33.6-8.4 mm ² Class 5	33.6-13.3 mm ² Class 1 33.6-13.3 mm ² Class 2 33.6-8.4 mm ² Class 5	8.4-2.1 mm ² Class 2 8.4-2.1 mm ² Class 5	8.4-2.1 mm ² Class 2 8.4-2.1 mm ² Class 5
YH6C6C	YH6C6CWCC	YH6C6CWC	1	13.3-5.3 mm ² Class 2 13.3-5.3 mm ² Class 5	13.3-5.3 mm ² Class 2 13.3-5.3 mm ² Class 5	—	—
YH8C8C	YH8C8CWCC	YH8C8CWC	4	8.4-2.1 mm ² Class 2 8.4-2.1 mm ² Class 5	8.4-2.1 mm ² Class 2 8.4-2.1 mm ² Class 5	—	—

• Use PUADP1 adaptor with U dies in 46 Series.

▲ See tooling section of this catalog for complete tool and die listings.

* Not CSA Certified.

Note: All H-Taps ROHS compliant.

Note: All dimensions shown are for reference only.

TYPE YH (Continued)

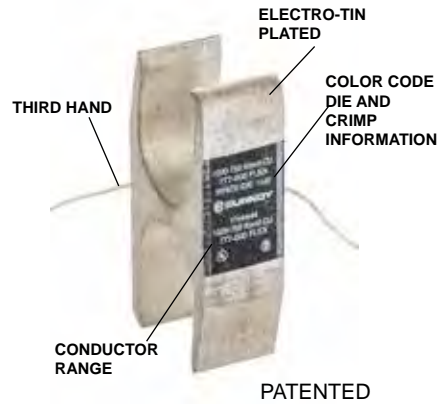

TABLE 3 INSTALLATION TOOLING + DIMENSIONS

Catalog Number	Kit Catalog Number		Fig. No.	Color Code Die Index	Dimensions			Wire Strip Length	▲ Hydraulic Tooling (No. of Crimps)		Kitted Cover Catalog #	
	Flame Retardant Cover				H	W	Length		35, 750 Series	46* Series	Clear Cover	Black Cover
	Clear	Black ‡										
YH4444	YH4444WCC	YH4444WC	1	White 1102	3.38	1.70	1.00	1-1/4	—	P1102 (1)	CCFR-FR	CFR-FR
YH4434	YH4434WCC*	YH4434WC	6	White 1102	3.38	1.70	1.00	1-3/8	—	P1102 (1)	CCFR-FR	CFR-FR
YH4429	YH4429WCC	YH4429WC	5	Yellow KR	3.22	1.70	1.00	1-3/8	—	PYFR (1)	CCFR-FR	CFR-FR
YH3939	YH3939WCC	YH3939WC	1	Yellow KR	2.97	1.50	1.25	1-3/8	—	PYFR (1)	CCFR-FR	CFR-FR
YH3931	YH3931WCC	YH3931WC	2	Yellow KR	2.97	1.50	0.95	1-1/16	—	PYFR (1)	CCFR-FR	CFR-FR
YH3434	YH3434WCC	YH3434WC	1	Brown 1104	2.43	1.15	1.00	1-1/8	U1104M (1) U1104 (2)	P1104 (1) U1104M (1)	CCFN-FR	CFN-FR
YH3429	YH3429WCC	YH3429WC	2	Brown 1104	2.43	1.31	1.00	1-1/8	U1104M (1) U1104 (2)	P1104 (1) U1104M (1)	CCFN-FR	CFN-FR
YH2929	YH2929WCC	YH2929WC	1	Purple 654	1.85	0.90	0.90	1-1/16	U654 (1)	U654 (1) P654 (1)	CCFD-FR	CFD-FR
YH292C	YH292CWCC	YH292CWC	3	Purple 654	1.52	0.90	0.90	1-1/16	U654 (1)	U654 (1) P654 (1)	CCFD-FR	CFD-FR
YH298C	YH298CWCC	YH298CWC	3	Purple 654	1.52	0.90	0.90	1-1/16	U654 (1)	U654 (1) P654 (1)	CCFD-FR	CFD-FR
YH2C2C	YH2C2CWCC	YH2C2CWC	4	Brown C	1.25	0.60	0.75	7/8	UC (1)	UC (1)	CCFO-FR	CFO-FR
YH6C6C	YH6C6CWCC	YH6C6CWC	1	Orange BG	0.81	0.39	0.60	3/4	UBGRT (1)	UBGRT (1)	CCFBG-FR	CFBG-FR
YH8C8C	YH8C8CWCC	YH8C8CWC	4	Green 11	0.63	0.40	0.60	3/4	U11T1 (1)	U11T1 (1)	CCFBG-FR	CFBG-FR

• Use PUADP1 adaptor with U dies in 46 Series.

* Not CSA Certified.

▲ See tooling section of this catalog for complete tool and die listings.

Note: All H-Taps ROHS compliant.

Note: All dimensions shown are for reference only.

TYPE CF-FR

H-Tap Black Flame Retardant Cover

UL Listed 90° C, Up to 600 Volts



Features & Benefits

- Insulation cover that has a one-piece hinge design so not extra hardware is required
- After an H-tap connection is made, the appropriate CF-FR cover can be used to slip over the connection and latches securely shut
- The use of the insulation cover eliminates the need to tape the connection, making this solution a fast and reliable method of insulating
- Flash Barrier; the cover is designed to protect against electrical flashover
- Type CF-FR cover material has a UL94 V-O Flame rating with a minimum 28 oxygen index that indicate self-extinguishing retardant properties
- Covers are clearly marked with lettering
- BURNDY certifies its products using the BURNDY Engineered System and select other crimp tool manufacturers in accordance with one or more of the UL categories in order to obtain a UL Listing

Catalog Number	Max. Conductor Accommodated	Matched H Copper CRIMPIT™	Max. Connector Length	Connector Color Code
CFBGFR	#8 AWG	YH8C8C	0.65	Green
	#6 AWG	YH6C6C	0.65	Orange
CFOFR	#2 AWG	YH2C2C	0.80	Brown
CFDFR	250 kcmil	YH292C, YH298C, YH2929	0.95	Purple
CFNFR	500 kcmil	YH3434, YH3429*	1.10	Brown
CFRFR	750 kcmil	YH3939, YH3931, YH4429	1.30	Yellow
	1000 kcmil	YH4434, YH4444	1.10	White

* Use CFN-FR for single tap installation; use CFR-FR when 2 or more tap conductors are installed.

† Two-piece design packaged together.

Note: All dimensions shown are for reference only.

TYPE CCF-FR

Clear H-Tap Flame Retardant Cover

UL Listed 90° C, Up to 600 Volts

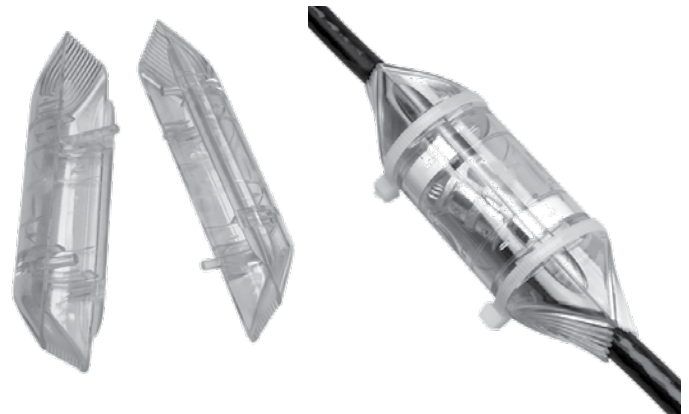

Features & Benefits

- Insulation cover that has a two-piece design with positive locking latch to ensure correct installation; prevents opening after installation
- After an H-tap connection is made, the appropriate Type CCF-FR cover can be used to slip over the connection and latch securely shut
- Embedded magnifying lense in the cover provides increased visibility of the H-tap die embossment on the connector made by the require installation tooling; this allows for improved visibility during a connection inspection
- Made of polished clear polycarbonate material that provides:
 - High visibility for inspection of installed H-tap connection
 - Built-in channels on the outside of the covers accommodate and hold cable ties, hook and loop ties, or waxed cord security in place after cover installation
 - Patented highly flexible fingers on each cover are designed to contour around the wire
 - Internal pockets designed to accommodate identification tags (4 ID tags included)
 - UL94 V-O Flame rating indicating self-extinguishing retardant properties
- The use of the insulation cover eliminates the need to tape the connection making this solution a fast and reliable method of insulating
- Molded barrier prevents installed H-tap connectors from electrical flashover
- Covers come with two (2) clear halves, two (2) cable ties, and four (4) identification tags

- Covers are clearly marked with lettering
- BURNDY certifies its products using the BURNDY Engineered System and select other crimp tool manufacturers in accordance with one or more of the UL categories in order to obtain a UL Listing

Catalog Number	Max. Conductor Accommodated	Matched H Copper CRIMPIT™	Max. Connector Length	Connector Color Code
CCFBGFR	#8 AWG	YH8C8C	0.65	Green
	#6 AWG	YH6C6C	0.65	Orange
CCFOFR	#2 AWG	YH2C2C	0.80	Brown
CCDFR	250 kcmil	YH292C, YH298C	0.95	Purple
CCFDXFR	250 kcmil	YH2929	0.95	Purple
CCFNFR	500 kcmil	YH3434, YH3429*	1.10	Brown
CCFRFR	750 kcmil	YH3939, YH3931, YH4429, YH4434, YH4444	1.30	Yellow
	1000 kcmil	YH4444	1.10	White

* Use CCFNFR for single tap installation; use CCFRFR when 2 or more tap conductors are installed.

Note: All dimensions shown are for reference only.

TYPE YSH

H Copper CRIMPIT™ Split Compression Wye Tap Connector

Type YSH heavy duty connectors are designed for insulated underground wye splices. The split H copper CRIMPIT™ connector is longer than our standard H copper CRIMPIT™ and is suitable for use on high voltage (15kV) power cables with copper conductors. The connectors cannot be used with oil filled or mass impregnated cables since no oil stop is provided. The connector is installed with standard BURNDY® HYPRESS™ tools and is made of tin-plated electrolytic copper.

Features & Benefits

- Range taking H-tap that allows for less inventory as one H-tap can accommodate a multitude of wire combinations
- Accommodates a wide range of run / tap combinations
- The tap grooves act independently; the use of one run and one tap wire is required when using this connector for making a connection
- Manufactured from high conductivity wrought copper providing low resistance for excellent electrical conductivity
- Electro-tin plated unless otherwise specified to reduce galvanic corrosion (bimetallic) and resist corrosive elements
- Color coded to ensure proper die and installation tooling is selected
- Insulation is not provided; insulation may be obtained from Raychem (800-272-9243) Type HVSJ Splice Kits for 15kV installations; a complete IEEE 404 15kV installation is provided

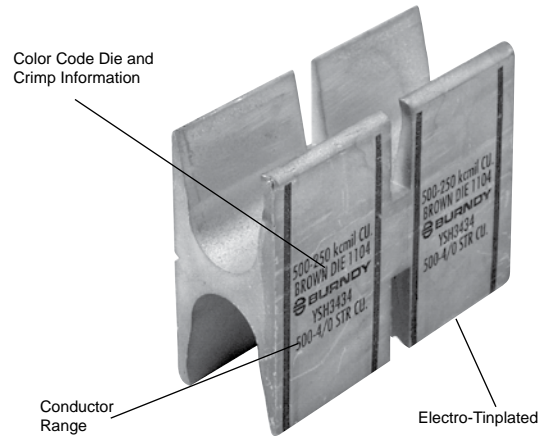

Expanded Tap 1 Components	
Expanded Catalog Number	Tap 1 Range
YSH-292C-E	#2 Str.
YSH-2925-E	1/0 Str.

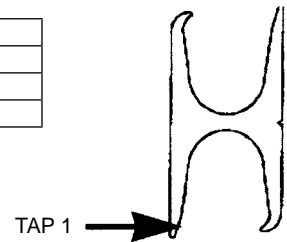

Fig. 1

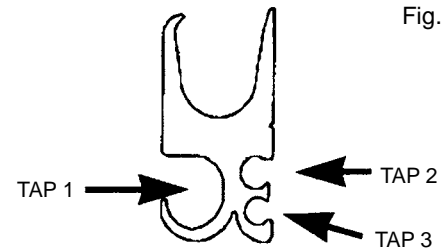
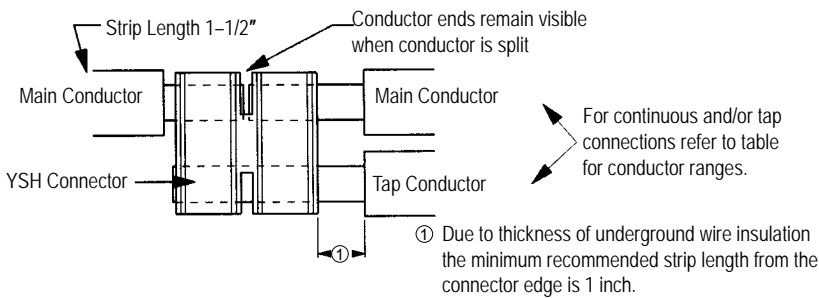

Fig. 2

Catalog Number	Fig. #	Conductor Sizes Code Expanded Tap 1 (Flex Cable)				750 Series	†	46* Series	†	Color Code	Die Index ▲ & Embossment	H	W	L	Wire Strip Length
		AWG	Tap 1	Tap 2	Tap 3										
YSH2929	1	250 kcmil - #2 AWG (4/0 - 2)	250 kcmil - #2 AWG (4/0 - 2)	-	-	U654	4	P654	2	Purple	654	1.85 in	0.90 in	3.00 in	1 1/2
YSH3429	2	500 kcmil - 4/0 AWG (350 - 4/0)	250 kcmil - 1/0 AWG (4/0 - 1/0)	#1 - #6 AWG (1 - 8)	#8 - #14 AWG (8 - 14)	U1104	4	P1104	2	Brown	1104	2.23 in	1.31 in	3.00 in	1 1/2
YSH3434	1	500 - 250 kcmil (350 - 4/0)	500 kcmil - 4/0 AWG (350 - 4/0)	-	-	U1104	4	P1104	2	Brown	1104	2.43 in	1.15 in	3.00 in	1 1/2
YSH3931	2	750 - 350 kcmil (550 - 500)	4/0 - 1/0 AWG (350 - 1/0)	#1 - #6 AWG (1 - 8)	#2 - #14 AWG (2 - 14)	-	-	PYFR	2	Yellow	KR	2.97 in	1.50 in	3.00 in	1 1/2
YSH3939	1	750 - 500 kcmil (550 - 500)	750 - 350 kcmil (550 - 350)	-	-	-	-	PYFR	2	Yellow	KR	2.97 in	1.50 in	3.00 in	1 1/2

* Use PUADP1 adaptor with U dies in 46 Series. P dies result in a smooth crimp surface and is recommended for voltages above 600 V.

▲ See tooling section of this catalog for complete tool and die listings.

† Number of crimps per connector. U dies require double crimps.

Note: All dimensions shown are for reference only.

TYPES YFD, YFN, YFO, YFR

H-CRIMPIT™ Aluminum Compression Tap Connector



UL Listed 90° C, Up to 35 kV ♦

H-CRIMPIT™ compression tap connectors Types YFD, YFN, YFO, and YFR are for use with aluminum to aluminum and aluminum to copper connections.

The H-CRIMPIT™ taps are ideal for making both parallel and tap compression connections in risers and gutters. It should only be installed with hydraulic tools.

Features & Benefits

- Aluminum H Taps are dual rated to accommodate both copper and aluminum wire and are indicated with AL-CU on the connector:
 - AL9CU indicates the terminal can accommodate aluminum and copper wire and is UL Listed 90°C, up to 35kV
 - AL7CU indicates the terminal can accommodate aluminum and copper wire and is UL Listed 75°C, up to 35kV
- Each connector is factory sealed in polyethylene to ensure connector is delivered free of foreign materials prior to being installed
- Post crimp, the connector is easy to tape
- Connectors are clearly marked
- Factory pre-filled with PENETROX™ Type A13 oxide inhibitor
- Aluminum oxidation is not easily detected but causes resistance in a connection so it is imperative that the proper preparation takes place prior to making an aluminum-to-aluminum connection
- BURNDY certifies its products using the BURNDY Engineered System and select other crimp tool manufacturers in accordance with one or more of the UL categories in order to obtain a UL Listing

DIE AND COLOR CODE
AND CRIMP INFORMATION

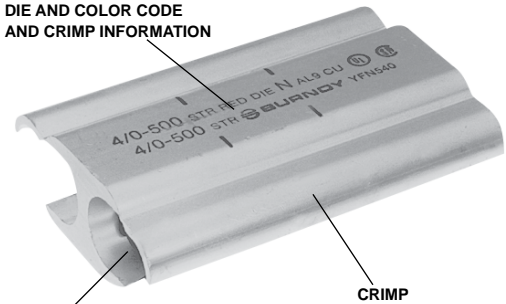

PRE-FILLED WITH
PENETROX

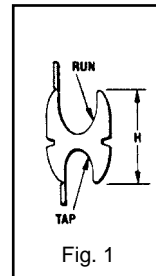

Fig. 1

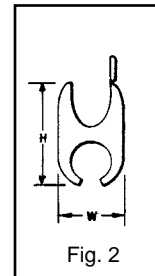

Fig. 2

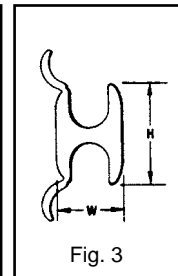

Fig. 3

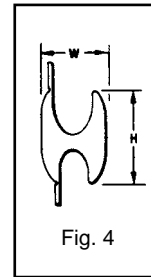
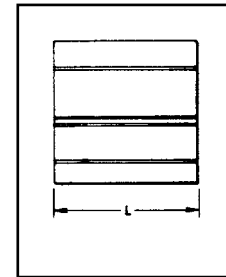

Fig. 4



Accommodates ②						Catalog Number	Fig. #	H	L	W	Installation Tooling ▲					Wire Strip Length
Copper or Aluminum		Compact ④		Dia. Range							Die Index	Color Code	Hydraulic Tools, Die Sets (No. of Crimps)			
Run	Tap	Run	Tap	Run	Tap								750, 35 Series	46 ⑤ Series	()	
1/0-6 AWG	1-6 AWG	2/0-6	1-6 Str	.398-.162	.332-.162	YFO140	1	1.15	1.62	0.70	O	Green	UYFO, UO	UYFO, UO	(2)	1-7/8
4/0-1 AWG	2/0-1 AWG	250-1/0	3/0-1/0	.563-.338	.477-.338	YFD365	1	1.42	2.50	0.89	D3	Blue	UD3 UYFD	UD3 UYFD	(3)	2-3/4
500-4/0	500-4/0	500-250	500-250	.815-.522	.815-.522	YFN540	3	1.82	4.50	1.23	N	Red	UN UYFN	PN PYFN	(3)	4-7/8
900-600	600-350	900-700	600-400	1.108-.877	.893-.659	YFR865	4	3.04	4.62	1.74	KR	Yellow	—	PKR PYFR	(4)	5

▲ See tooling section of this catalog for complete tool and die listings.

♦ For applications greater than 2000 Volts consult cable manufacturer for voltage stress relief instructions.

* CSA Listed

Note: All dimensions shown are for reference only.

① Material: Aluminum.

② For Conductor combinations of AL to AL or AL to CU.

③ Catalog Number PUADP1 adaptor is required to use U type dies in 46 series tools; **do not use UYFN die set with PUADP1; use PYFN only.**

④ Other conductors not listed in table can be accommodated as long as the conductor diameter falls within diameter range specified.

Compression Connections

Copper Compression
HYPLUG™ Adapters for Copper Conductor

TYPES YE-V-P-FX, YE-P-FX

HYPLUG™



Wire Connector Adapter Rated for 90° C, Up to 35 kV ♦

Types YE-V-P-FX and YE-P-FX copper compression adapters are designed for reliable termination of copper conductor when the current capacity of the conductor is downsized, but larger conductor is utilized. Typical applications are for voltage drop protection when oversized conductors are used or flex conductor is used. These adapters facilitate the termination into existing mechanical set screw connectors for various stranded copper cables.

Features & Benefits

- Connector: Uninsulated copper compression pin adapter
- Connection: irreversible and maintenance free
- cULus Listed Wire-Connector Adapters; Tested in accordance to UL 486A-486B Wire Connector Adapters, CSA C22.2 No. 65 Wire Connectors
 - For applications greater than 2000 Volts consult cable manufacturer for voltage stress relief applications
- Connectors without covers: Temperature and voltage rating 90°C, up to 35kV
- Accommodates a variety of conductor types and sizes (see tables for specifics)
 - Code Copper Wire Class B (Concentric, Compressed, Compact), Class C
 - Flexible Wire Classes
- Pin Adapters are tin plated unless otherwise specified; other plating options available (add suffix applicable)
 - Nickel (-NK), Silver (-SV), Tin-Zinc (-TZ), Unplated Bare (-BR)
- Pin adapters are clearly marked with wire size, color code, and crimp location bands
- Barrel designed with an internal chamfer at the wire entry to ensure smooth wire insertion
- Long barrel lengths allow for an increased number of crimps, increasing the mechanical strength of the connector
- In order to obtain a UL Listing and CSA Certification BURNDY certified its products using the BURNDY Engineered System. BURNDY connectors can receive a UL Listing and CSA Certification with other crimp tool manufacturers installation tools
- Solid pin design is rated to carry the equivalent ampacity of the incoming wire being terminated
- Covers are supplied with the connectors
 - Material types include: Santoprene or PVC
 - UL Listed and CSA Certified; Temperature and voltage rating up to 90°C and 600 Volts
- For installation instructions, see the product sales drawing that can be found on our website

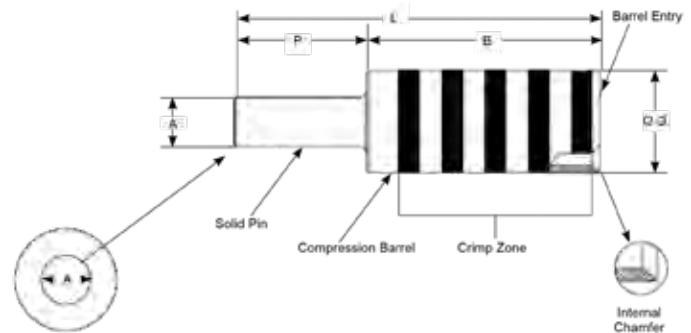

Accessories

- Hardware - Section F
- PENETROX™ Oxide Inhibitor - Section F
- Heat and Cold Shrink Tubing - Section D
- WIREMIKE™ Wire Micrometer - Section F
- Wire Management (Cable Ties) - Section G

TYPES YE-V-P-FX, YE-P-FX (Continued)



WIRE
CONNECTOR
ADAPTER

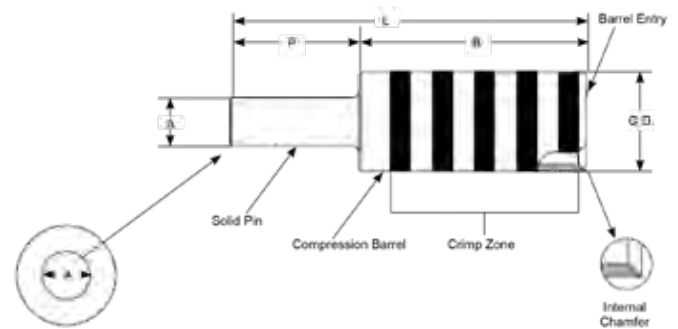

Note: up to 600 Volts, 90°C EPDM or Santoprene rubber covers supplied with the connector

Catalog Number	Accommodates Copper Wire Sizes		Pin Size Solid Wire Equiv.	Dimensions					Color Code Die Index	Wire Strip Length	Cover Catalog Number
	Code Conductor Class B,C	Flex Conductor Classes (as listed)		Outside Dia. (OD)	Overall Length (L)	Barrel Length (B)	Pin Length (P)	Pin Dia. (A)			
YE4V4CP6X75FX	4 AWG	4 G,H,I,K,M, DLO	6 AWG	0.38	2.05	1.30	0.75	0.16	Gray 8	1-1/4	AYP6C
YE2V2CP4X75FX	2 AWG	2 G,H,I,K,M, DLO	4 AWG	0.46	2.07	1.32	0.75	0.21	Brown 10	1-1/4	AYP6C
YE1V1CP3X84FX	1 AWG	1 G,H,I,K,M, DLO	3 AWG	0.51	2.17	1.33	0.84	0.23	Green 11	1-1/4	AYP6C
YE2V2P2X84FX	1/0 AWG	1/0 G,H,I,K,M, DLO	2 AWG	0.56	2.54	1.70	0.84	0.26	Pink 12	1-3/4	AYP26C
YE2V2P1X84FX	2/0 AWG	2/0 G,H,I,K,M, DLO	1 AWG	0.63	2.56	1.72	0.84	0.29	Black 13	1-3/4	AYP26C
YE2V27P1/0X84FX	2/0 AWG	3/0 G,H,I,K,M, DLO	1/0 AWG	0.70	2.58	1.74	0.84	0.33	Orange 14	1-3/4	AYP26C
YE2V28P2/0X100FX	4/0 AWG	4/0 G,H,I,K,M, DLO	2/0 AWG	0.77	2.76	1.76	1.00	0.37	Purple 15	1-3/4	AYP26C
YE2V29P3/0X109FX	250 kcmil	4/0 G,H,I,K,M, DLO	3/0 AWG	0.80	2.85	1.76	1.09	0.41	Yellow 16	1-3/4	AYP26C
YE31P4/0X110FX	300 kcmil 350 kcmil	250 kcmil G,H,I,K 262 kcmil DLO	4/0 AWG	0.88	3.47	2.37	1.10	0.46	White 17	2-1/4	AYP250C
YE32P250X125FX	400 kcmil	300 kcmil G,H,I,K 313 kcmil DLO	250 kcmil	0.95	3.64	2.39	1.25	0.51	Blue 19	2-1/4	AYP250C
YE34P250X125FX	500 kcmil	350 kcmil G,H,I,K 373 kcmil DLO	250 kcmil	1.06	3.66	2.41	1.25	0.51	Brown 20	2-1/4	AYP250C
YE36P350X150FX	600 kcmil	500 kcmil G,H 444 kcmil DLO	350 kcmil	1.19	3.72	2.22	1.50	0.59	Green 22	2-1/4	AYP400C
YE38P350X150FX	700 kcmil	500 kcmil H,I,K 550 kcmil G,H,I 535 kcmil DLO	350 kcmil	1.25	3.77	2.27	1.50	0.59	Pink 400	2-1/4	AYP400C
YE39P500X150FX	750 kcmil	600 kcmil G,H,I,K 646 kcmil DLO	500 kcmil	1.30	3.85	2.35	1.50	0.71	Black 24	2-1/4	AYP400C
YE44P600X170FX	1000 kcmil	750 kcmil G,H,I 777 kcmil DLO	600 kcmil	1.50	4.17	2.47	1.70	0.78	White 27	2-3/8	AYPO900C

Tooling Table:

Catalog Number	Color Code Die Index	Wire Strip Length	Installation Tools (# Crimps)						
			MD6, 600, 500 Series (W-RT Dies)	MD6, 600, 500 Series (W-VT Dies)	750, 35 Series	45 Series (Use PT6515 with U Dies)	46 Series (Use with PUADP1 with U Dies)	81K, 4PC Series (Dieless)	Y644MBH Remote Head (Dieless)
YE4V4CP6X75FX	Gray 8	1-1/4	W4CRT (2)	W4CVT (2)	U4CRT (2)	U4CRT (2)	U4CRT (2)	2 Crimps	1 Crimp
YE2V2CP4X75FX	Brown 10	1-1/4	W2CRT (2)	W2CVT (2)	U2CRT (2)	U2CRT (2)	U2CRT (2)	2 Crimps	1 Crimp
YE1V1CP3X84FX	Green 11	1-1/4	W1CRT (2)	W1CVT (2)	U1CRT1 (2)	U1CRT1 (2)	U1CRT1 (2)	2 Crimps	1 Crimp
YE2V2P2X84FX	Pink 12	1-3/4	W25RT (4)	W25VT (2)	U25RT (2)	U25RT (2)	U25RT (2)	2 Crimps	1 Crimp
YE2V2P1X84FX	Black 13	1-3/4	W26RT (4)	W26VT (2)	U26RT (2)	U26RT (2)	U26RT (2)	2 Crimps	1 Crimp
YE2V27P1/0X84FX	Orange 14	1-3/4	W27RT (4)	W27VT (2)	U27RT (2)	U27RT (2)	U27RT (2)	2 Crimps	1 Crimp
YE2V28P2/0X100FX	Purple 15	1-3/4	W28RT (4)	W28VT (2)	U28RT (2)	U28RT (2)	U28RT (2)	2 Crimps	1 Crimp
YE2V29P3/0X109FX	Yellow 16	1-3/4	W29RT (4)	W29VT (2)	U29RT (2)	U29RT (2)	U29RT (2)	2 Crimps	1 Crimp
YE31P4/0X110FX	White 17	2-1/4	W30RT (4)	—	U30RT (4)	U30RT (4)	U30RT (4)	3 Crimps	1 Crimp
YE32P250X125FX	Blue 19	2-1/4	W32RT (4)	—	U32RT (4)	U32RT (4)	U32RT (4)	3 Crimps	1 Crimp
YE34P250X125FX	Brown 20	2-1/4	W34RT (4)	—	U34RT (4)	U34RT (4)	U34RT (4)	3 Crimps	1 Crimp
YE36P350X150FX	Green 22	2-1/4	—	—	U36RT (4)	U36RT (4)	U36RT (4)	3 Crimps	1 Crimp
YE38P350X150FX	Pink 400	2-1/4	—	—	U38RT (4)	U38RT (4)	U38RT (4)	3 Crimps	1 Crimp
YE39P500X150FX	Black 24	2-1/4	—	—	U39RT (4)	S39RT (4)	P39RT (4)	3 Crimps	1 Crimp
YE44P600X170FX	White 27	2-3/8	—	—	—	S44RT (4)	P44RT (4)	3 Crimps	1 Crimp

TYPES AYP, AYPO

HYPLUG™ Adapters

UL Listed 90° C, Up to 35 kV ♦



AL9CU



AL9CU

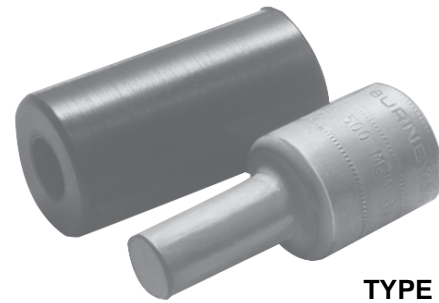

TYPE AYP

Types AYP and AYPO aluminum compression adapters are designed for reliable termination of aluminum and copper conductor in mechanical connectors. Typical applications include mechanical connectors in molded case circuit breakers, panel board equipment, and meter sockets.

Features & Benefits

- Aluminum pin terminals are dual rated to accommodate both copper and aluminum wire and are indicated with AL-CU on the connector:
 - AL9CU indicates the terminal can accommodate aluminum and copper wire and is UL Listed 90°C, up to 35kV
 - AL7CU indicates the terminal can accommodate aluminum and copper wire and is UL Listed 75°C, up to 35kV
- Short pin length design permits easy installation in limited space applications; rated for the full ampacity of the incoming conductor
- Smooth surface on the pin allows for greater contact area and electrical connectivity
- Solid pin design eliminates “how tight is tight” torque requirement problem and eliminates over torquing on stranded pin adapters that can result in damaged strands increasing resistance
- Barrel is designed with an internal chamfer at the wire entry to ensure smooth insertion of the wire, preventing possible damaging of the wire strands during insertion
- Electro-tin plated unless otherwise specified to reduce galvanic corrosion (bimetallic) and resist corrosive elements
- Connectors are clearly marked with wire size, die index, color code, and crimp location bands
- Factory pre-filled with PENETROX™ Type A13 oxide inhibitor
- Color coded end caps are factory inserted in the barrels to match the die color code and prevent foreign materials from entering the barrel
- Aluminum oxidation is not easily detected but causes resistance in a connection; it is imperative the proper preparation takes place prior to making an aluminum-to-aluminum connection
- Covers are supplied with connectors:
 - EPDM rubber covers are UL Listed/CSA Certified and rated up to 600 Volts and 90°C
 - Santoprene rubber covers are also UL Listed/CSA Certified and rated up to 600 Volts and 90°C

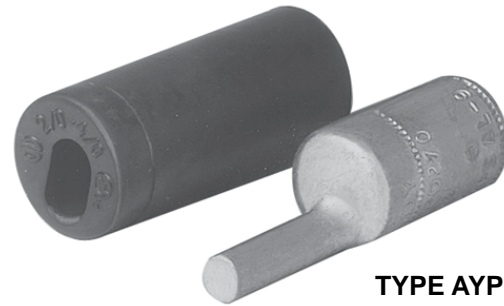

TYPE AYPO

- The connector is offered with an in-line pin (Type AYP) and offset pin (Type AYPO) design
- Offset pin design provides added flexibility in limited space applications as the connectors can be rotated preventing wire interference when installing cable side-by-side to a mechanical connector
- Only 5 dies sets are necessary to install the complete line of HYPLUG™ adapters from #6 AWG up to 750 kcmil
- BURNDY certifies its products using the BURNDY Engineered System and select other crimp tool manufacturers in accordance with one or more of the UL categories in order to obtain a UL Listing
- Conductor Accommodate Types:
 - Aluminum Code Wire: Class B (Concentric, Compressed, Compact)
 - Copper Code Wire: Class B (Concentric, Compressed, Compact or Class C)
 - Copper Clad Aluminum: Noted in the conductor accommodates as CCA

Accessories

- Hardware - Section F
- PENETROX™ Oxide Inhibitor - Section F
- Heat and Cold Shrink Tubing - Section D
- WIREMIKE™ Wire Micrometer - Section F
- Wire Management (Cable Ties) - Section G

♦ For applications greater than 2000 Volts consult cable manufacturer for voltage stress relief instructions.

TYPES AYP, AYPO (Continued)



AL9CU



AL9CU

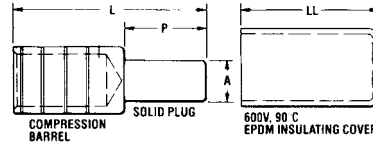

Fig 1: TYPE AYP (Straight)

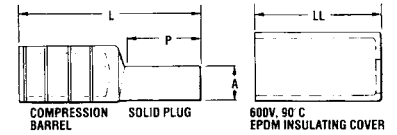
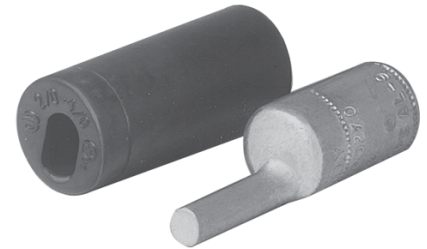

Fig 2: TYPE AYPO (Offset)

Catalog Number	AL Class B CU Class B, C	Copper Flex	Fig. No.	Dimensions					Installation Tooling ▲				Wire Strip Length			
				A ▼ Pin Dia.	Pin Size Equiv.	P Pin Length	L Overall Length	LL Cover Length	HYTOOL™		Die Index & Emboss.					
									Dieless Tools (# of crimps)	+ MD6		35 & 750, 46* Series Die Number (# of crimps)		Color Code		
AYP6	6 AWG ●	#8 Class I, DLO	1	0.23	4 AWG	0.68	1.85	2.03	MY293 (2)** 444 Series (1) 644 Series (1) 81K Series (1)	W241 (2)	U25ART (1)	Tan	296	1-1/16		
AYP4	4 AWG	#6 Class I, DLO	1	0.23	4 AWG	0.68	1.85	2.03								
AYP2	2 AWG	#4 Class I, DLO	1	0.23	4 AWG	0.68	1.85	2.03								
AYP1	1 AWG	#2 Class I, DLO	1	0.26	3 AWG	0.84	2.01	2.03								
AYP1/0	1/0 AWG	#1 Class I, DLO	1	0.29	2 AWG	0.84	2.01	2.03								
AYPO2/0	2/0 AWG	1/0 Class I, DLO	2	0.33	1 AWG	1.09	2.70	2.23	MY293 (2)** 444 Series (1) 644 Series (1) 81K Series (2)	W660 (4)	U28ART (2)	White	298	1-1/8		
AYPO3/0	3/0 AWG	2/0 Class I, DLO	2	0.37	1/0 AWG	1.22	2.80	2.23								
AYPO4/0	4/0 AWG	3/0 Class I, DLO	2	0.42	2/0 AWG	1.22	2.80	2.23								
AYP250	250 kcmil	4/0 Class I, K, M, DLO	1	0.47	3/0 AWG	1.16	2.63	2.54	444 Series (1) 644 Series (1) 81K Series (2)	—	U31ART (2)	Brown	299	1-1/8		
AYPO250	250 kcmil		2	0.47	3/0 AWG	1.22	2.98	2.54								
AYPO300	300 kcmil	250 kcmil Class I, 262 DLO	2	0.53	4/0 AWG	1.34	3.08	2.54								
AYP350	350 kcmil	313 kcmil DLO	1	0.57	250 kcmil	1.34	2.75	2.54								
AYPO350	350 kcmil		2	0.57	250 kcmil	1.34	3.08	2.54								
AYPO400	400 kcmil	—	2	0.63	300 kcmil	1.60	3.43	2.81								
AYP500	500 kcmil	373 kcmil Class I, 373 DLO	1	0.68	350 kcmil	1.60	3.08	2.81								
AYPO500	500 kcmil		2	0.68	350 kcmil	1.60	3.43	2.81								
AYPO600	600 kcmil	444 kcmil DLO	2	0.73	400 kcmil	1.64	4.02	3.69								
AYP750	700 - 750 kcmil ‡900 kcmil Compact AL	535 kcmil DLO	1	0.81	500 kcmil	1.76	3.79	3.69			444 Series (1) 644 Series (1) 81K Series (3)	—	U39ART2 (3)	Yellow	936	1-3/4
AYPO750			2	0.81	500 kcmil	1.76	4.16	3.69								
AYP900	900 kcmil AL	—	1	0.91	650 kcmil	1.82	4.10	4.20								
AYPO900		—	2	0.91	650 kcmil	1.82	4.16	4.20								
AYPO1000	1000 kcmil	777 kcmil DLO	2	0.81	500 kcmil	1.76	4.17	—	444 Series (1) Y644MBH only (1)	—	—	—	—	1-3/4		

Scratch brushing of all conductors before making installation is recommended

▲ See tooling section of this catalog for complete tool and die listings.

** For MY293 use aluminum index plate at 1/0 setting for sizes #6 through 1/0 or at 4/0 setting for sizes 2/0 through 4/0.

+ Not UL Listed with these tools.

* Use PUADP1 adaptor with U dies in 46 Series Tools

■ Also accommodates compressed and compact conductors (except for 700 kcmil in 750 kcmil barrel).

‡ Listed using 444S / 644 Series Tools only.

◆ For applications greater than 2000 Volts consult cable manufacturer for voltage stress relief instructions.

▼ For copper equivalent wire size see Section O for Aluminum 1350 Cable Reference

All dimensions shown are for reference only.

● Aluminum wire only for 444S and 644 Series tooling

TYPE YST

Uninsulated Copper HYTEE™ T-Coupler



UL Listed to 90° C, Up to 35 kV ♦

Type YST copper compression tee is designed for connecting a run conductor with a perpendicular tap conductor. Type YST connectors are commonly used in junction boxes and manholes to make a radial tap off a main run. They are needed in many industrial, utility generation, and commercial applications. The most common cable combinations are listed below. The Type Y-R reducers can also be used to accommodate most cable combinations.

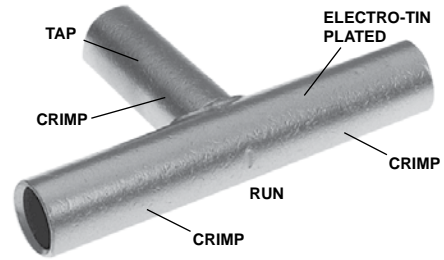

Features & Benefits

- Manufactured from high conductivity electrolytic copper tubing with heavy wall thickness, Type YST T-couplers provide low resistance for excellent electrical conductivity
- Featuring long barrel length for all three wire wire accommodating barrels allows for an increased number of crimps, in turn increasing the mechanical strength of the connection while allowing the connection to operate at a lower temperature rating; additionally, the long barrel permits the use of the Type Y-R reducing adapters
- Accommodates a wide range of run / tap combinations
- Electro-tin plated unless otherwise specified to reduce galvanic corrosion (bimetallic) and resist corrosive elements
- Connectors are clearly marked
- BURNDY certifies its products using the BURNDY Engineered System and select other crimp tool manufacturers in accordance with one or more of the UL categories in order to obtain a UL Listing

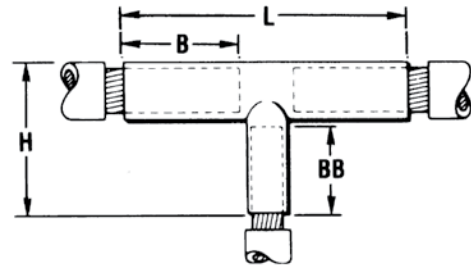

Catalog Number	Code • Conductors		Dimensions				Dieless (# of crimps)	Installation Tooling ▲						Wire Length	
								Run Conductors			Tap Conductors				
	Run	Tap	B	BB	H	L		35 ■, 750, 46* Series			35 ■, 750, 46* Series			Run	Tap
							Die Number (# of crimps)	Color Code	Die Index	Die Number (# of crimps)	Color Code	Die Index ▲			
YST4C4C	4 AWG	4 AWG	1.12	1.38	1.72	3.25	644 Series (1) 81K Series (1)	U4CRT (2)	Gray	8	U4CRT (2)	Gray	8	1-3/16"	1-3/16"
YST2C2C	2 AWG	2 AWG	1.25	1.56	1.98	3.56		U2CRT (2)	Brown	10	U2CRT (2)	Brown	10	1-5/16"	1-5/16"
YST2525	1/0 AWG	1/0 AWG	1.38	1.56	1.91	3.81		U25RT (2)	Pink	12	U25RT (2)	Pink	12	1-7/16"	1-7/16"
YST2626	2/0 AWG	2/0 AWG	1.50	1.67	2.18	3.94		U26RT (2)	Black	13	U26RT (2)	Black	13	1-9/16"	1-9/16"
YST282C	4/0 AWG	2 AWG	1.62	1.50	2.12	3.94		U28RT (2)	Purple	15	U2CRT (2)	Brown	10	1-11/16"	1-5/16"
YST2825	4/0 AWG	1/0 AWG	1.62	1.56	2.25	4.00		U28RT (2)	Purple	15	U25RT (2)	Pink	12	1-11/16"	1-5/8"
YST2828	4/0 AWG	4/0 AWG	1.62	1.75	2.44	4.19	—	U28RT (2)	Purple	15	U28RT (2)	Purple	15	1-11/16"	1-13/16"
YST2929	250 kcmil	250 kcmil	1.62	1.78	2.53	4.25	—	U29RT (2)	Yellow	16	U29RT (2)	Yellow	16	1-11/16"	1-11/16"
YST3131	350 kcmil	350 kcmil	2.00	2.25	3.12	5.50	644 Series (2) 81K Series (2)	U31RT (4)	Red	18	U31RT (4)	Red	18	2"	2"
YST3428	500 kcmil	4/0 AWG	2.25	1.75	2.81	5.81		U34RT (4)	Brown	20	U28RT (2)	Purple	15	2-5/16"	1-11/16"
YST3434	500 kcmil	500 kcmil	2.25	2.70	3.76	6.19		U34RT (4)	Brown	20	U34RT (4)	Brown	20	2-5/16"	2-5/16"
YST3939	750 kcmil	750 kcmil	2.88	3.34	4.64	8.12		U39RT (4)	Black	24	U39RT (4)	Black	24	2-15/16"	2-15/16"

* Use adapter PUADP1 with U Dies in 46 Series.

■ The maximum size for the Y35 is 400 kcmil.

● Contact factory for conductor combinations not shown.

▲ See tooling section of this catalog for complete tool and die listings.

♦ For applications greater than 2000 Volts consult cable manufacturer for voltage stress relief instructions.

Note: All dimensions shown are for reference only.

TYPE YCP-L

Compression Cable Pulling Heads

Before using this product, it is required to read, understand, and comply with the Safety Operation Maintenance & Installation manual provided with the product.

Features & Benefits

- Range-taking; only 7 compression pulling heads are required to pull #8 AWG through 1000 kcmil wire
- Accommodates:
 - Copper Class B (Concentric, Compressed, Compact) or Class C wire
 - Aluminum Class B (Concentric, Compressed, Compact)
- Easy to install with the 644 or 444S Series of dieless installation tools (PAT644 / Y644 or PAT444S)
- Parallel installation; each of the 7 compression pulling heads come in multiple lanyard lengths for staggering when pulling multiple wires
- Knurl crimp bands on the compression pulling head barrels clearly indicate the crimp zone location
- Each lanyard has a protective sleeve for comfort and safety
- A UPC tag is affixed to each part for ease of identification and ordering



PAT644 Series



PAT444S Series

Please Note: Sold packaged in quantities of 6 pieces; must order in multiples of 6.

Catalog Number	Barrel OD (in)	Wire Range (Cu & AL)	Lanyard Length (in)	Maximum Rated Pull Load per Cable (lbs)			Minimum Wire Strip Length (in)
				Wire Size	Copper (Concentric, Compress, Compact) Wire	Aluminum (Concentric, Compress, Compact) Wire	
YCP4CL13CTN	0.38	#8 - #4 AWG	13"	#8 AWG #6 AWG #4 AWG	130 210 300	130 210 300	644 Series 444S Series (1) 1.38"
YCP4CL20CTN			20"				
YCP4CL27CTN			27"				
YCP4CL34CTN			34"				
YCP25L13CTN	.51"	#4 - 1/0 AWG	13"	#4 AWG #3 AWG #2 AWG #1 AWG 1/0 AWG	300 400 500 1,200 1,200	300 400 400 400 400	644 Series 444S Series (1) 2.50"
YCP25L20CTN			20"				
YCP25L27CTN			27"				
YCP25L34CTN			34"				
YCP25L41CTN			41"				
YCP28L13CTN	.69"	2/0 AWG 3/0 AWG 4/0 AWG	13"	2/0 AWG 3/0 AWG 4/0 AWG	1,200 2,000 2,000	400 750 1,000	644 Series 444S Series (2) 3.00"
YCP28L20CTN			20"				
YCP28L27CTN			27"				
YCP28L34CTN			34"				
YCP28L41CTN			41"				
YCP31L13CTN	.88"	250 kcmil 300 kcmil 350 kcmil	13"	250 kcmil 300 kcmil 350 kcmil	2,000 4,000 4,000	1,200 1,500 1,800	644 Series 444S Series (3) 3.25"
YCP31L20CTN			20"				
YCP31L27CTN			27"				
YCP31L34CTN			34"				
YCP31L41CTN			41"				

Compression Connections

Compression Cable Pulling Heads
Type YCP-L

TYPE YCP-L (Continued)



PAT444S Series



PAT644 Series

Catalog Number	Barrel OD (in)	Wire Range (Cu & AL)	Lanyard Length (in)	Maximum Rated Pull Load per Cable (lbs)				Minimum Wire Strip Length (in)
				Wire Size	Copper (Concentric, Compress, Compact) Wire	Aluminum (Concentric, Compress, Compact) Wire	Dieless Installation Tooling (# of Crimps)	
YCP34L13CTN	1.06"	400 kcmil 450 kcmil 500 kcmil	13"	400 kcmil 450 kcmil 500 kcmil	4,000 5,000 5,000	2,000 2,400 2,700	644 Series 444S Series (3)	3.25"
YCP34L20CTN			20"					
YCP34L27CTN			27"					
YCP34L34CTN			34"					
YCP34L41CTN			41"					
YCP39L13CTN	1.30"	550 kcmil 600 kcmil 650 kcmil 700 kcmil 750 kcmil	13"	550 kcmil 600 kcmil 650 kcmil 700 kcmil 750 kcmil	5,000 5,000 5,000 5,000 5,000	3,600 3,600 3,600 3,600 3,600	644 Series 444S Series (3)	3.25"
YCP39L20CTN			20"					
YCP39L27CTN			27"					
YCP39L34CTN			34"					
YCP39L41CTN			41"					
YCP44L13CTN	1.50"	800 kcmil 900 kcmil 1000 kcmil	13"	800 kcmil 900 kcmil 1000 kcmil	5,000 5,000 5,000	3,600 3,600 5,000	644 Series 444S Series (3)	3.25"
YCP44L20CTN			20"					
YCP44L27CTN			27"					
YCP44L34CTN			34"					
YCP44L41CTN			41"					



PAT750 Series



†PAT46S Series

Installation Table using 750 or 46 Series Tooling

Catalog Number **	Barrel OD (in)	Wire Range (Cu & AL)	Maximum Rated Pull Load per Cable (lbs)				Minimum Wire Strip Length (in)	
			Wire Size	Copper (Concentric / Compress) Wire	Copper Compact Wire	Aluminum (Concentric, Compress, Compact) Wire		
YCP25L**CTN	.51"	1/0 AWG	1/0 AWG	1,200	550	400	U25RT (1)	2.50"
YCP28L**CTN	.69"	4/0 AWG	4/0 AWG	2,000	1,000	1,000	U28RT (2)	3.00"
YCP31L**CTN	.88"	350 kcmil	350 kcmil	4,000	1,400	1,800	U31RT (3)	3.25"
YCP34L**CTN	1.06"	500 kcmil	500 kcmil	5,000	2,200	2,700	U34RT (3)	3.25"
YCP39L**CTN	1.30"	750 kcmil	750 kcmil	5,000	2,200	3,600	U39RT (3)	3.25"
YCP44L**CTN	1.50"	1000 kcmil	1000 kcmil	5,000	2,200	5,000	U44XRT (3)	3.25"

** Lanyard length needs to be added for complete catalog number. Example: YCP34L13 is 13" Lanyard Length.

†46 Series requires PUADP1 adapter to use U dies.

TYPE YAEBA-S

Straight Style Battery Post Terminals

#6 - 4/0 AWG Solid and Stranded Copper

BURNDY straight style battery post terminals are made from pure copper alloy and tin plated to prevent corrosion. They adhere to SAE, JIS, and DIN stud standards. Typical applications are automotive, marine, transportation, petrochemical, and OEM markets.



Features & Benefits

Barrel:

- Color coded for easy identification
- Chamfered end
- Made of copper alloy, tin plated for corrosion resistance and RoHS compliance
- Supplied standard with stainless steel hardware installed

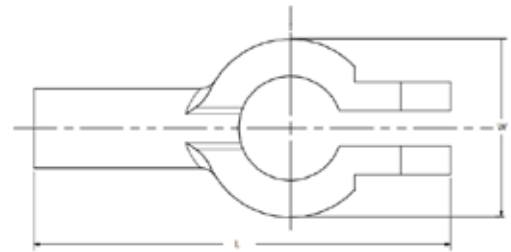

Post:

- Clamp color coded by polarity; red is positive, black is negative
- Not UL Listed but tested and met UL486A-486B pullout requirements

Catalog Number	Wire Range	Dimensions		Bulk Catalog Number	Conn. Color Code	Installation Tooling			Color Code Die	Die Index	Strip Length
		L	W			MD6, MD734R, 500, 600 Series	35, 750 Series	Dieless (# Crimps)			
YAEBAS6CNTN	#6	2.30"	0.98"	YAEBAS6CNTNOEM	Blue	W5CVT (1)	U5CRT (1)	81K Series (1) 4PC Series (1) 644 Series (1) MY2911 (1) MRC840 (1)	Blue	7	1-3/32"
YAEBAS6CPTN			1.02"	YAEBAS6CPTNOEM		W5CRT (1)					
YAEBAS4CNTN	#4		0.98"	YAEBAS4CNTNOEM	Gray	W4CVT (1)	U4CRT (1)		Gray	6	
YAEBAS4CPTN			1.02"	YAEBAS4CPTNOEM		W4CRT (1)					
YAEBAS2CNTN	#2		0.98"	YAEBAS2CNTNOEM	Green	W2CVT (1)	U2CRT (1)		Brown	10	
YAEBAS2CPTN			1.02"	YAEBAS2CPTNOEM		W2CRT (1)					
YAEBAS1CNTN	#1		0.98"	YAEBAS1CNTNOEM	Pink	W1CVT (1)	U1CRT (1)		Green	11	
YAEBAS1CPTN			1.02"	YAEBAS1CPTNOEM		W1CRT1 (1)					
YAEBAS25NTN	1/0	0.98"	YAEBAS25NTNOEM	Black	W25VT (1)	U25RT (1)	Pink	12			
YAEBAS25PTN		1.02"	YAEBAS25PTNOEM		W25RT (1)						
YAEBAS26NTN	2/0	0.98"	YAEBAS26NTNOEM	Orange	W26VT (1)	U26RT (1)	Black	13			
YAEBAS26PTN		1.02"	YAEBAS26PTNOEM		W26RT (1)						
YAEBAS27NTN	3/0	0.98"	YAEBAS27NTNOEM	Purple	W27VT (1)	U27RT (1)	Orange	14			
YAEBAS27PTN		1.02"	YAEBAS27PTNOEM		W27RT (1)						
YAEBAS28NTN	4/0	0.98"	YAEBAS28NTNOEM	Yellow	W28VT (1)	U28RT (1)	Purple	15			
YAEBAS28PTN		1.02"	YAEBAS28PTNOEM		W28RT (1)						

TYPE YAEBA-F

T-Style Battery Post Terminals

#2 - 4/0 AWG Solid and Stranded Copper

BURNDY T-Style battery post terminals are made from pure copper alloy and tin plated to prevent corrosion. They adhere to SAE, JIS, and DIN stud standards. Typical applications are automotive, marine, transportation, petrochemical, and OEM markets.



Features & Benefits

Barrel:

- Color coded for easy identification
- Chamfered end
- Made of copper alloy, tin plated for corrosion resistance and RoHS compliance
- Supplied standard with stainless steel hardware installed

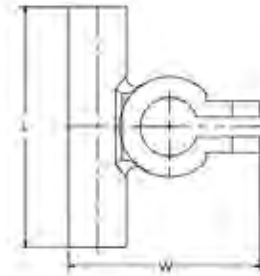

Post:

- Clamp color coded by polarity; red is positive, black is negative
- Not UL Listed but tested and met UL486A-486B pullout requirements

Catalog Number	Wire Range	Dimensions		Bulk Catalog Number	Conn. Color Code	Installation Tooling			Die Color Code	Die Index	Strip Length
		L	W			MD6, MD734R, 500, 600 Series	35, 750 Series	Dieless (# Crimps)			
YAEBAF2CNTN	#2	2.36	1.89	YAEBAF2CNTNOEM	Green	W2CVT (1)	U2CRT (1)	MY2911 (1) MRC840 (1)	Brown	10	1-9/32
YAEBAF2CPTN				YAEBAF2CPTNOEM		W2CRT (1)					
YAEBAF1CNTN	#1			YAEBAF1CNTNOEM	Pink	W1CVT (1)	U1CRT1 (1)				
YAEBAF1CPTN				YAEBAF1CPTNOEM		W1CRT1 (1)					
YAEBAF25NTN	1/0			YAEBAF25NTNOEM	Black	W25VT (1)	U25RT (1)				
YAEBAF25PTN				YAEBAF25PTNOEM		W25RT (1)					
YAEBAF26NTN	2/0	YAEBAF26NTNOEM	Orange	W26VT (1)	U26RT (1)	MY2911 (1) MRC840 (2)	Black	13			
YAEBAF26PTN		YAEBAF26PTNOEM		W26RT (1)							
YAEBAF27NTN	3/0	YAEBAF27NTNOEM	Purple	W27VT (1)	U27RT (1)						
YAEBAF27PTN		YAEBAF27PTNOEM		W27RT (1)							
YAEBAF28NTN	4/0	YAEBAF28NTNOEM	Yellow	W28VT (1)	U28RT (1)						
YAEBAF28PTN		YAEBAF28PTNOEM		W28RT (1)							

TYPE YAGB

One Hole Battery Grounding / Starter Lugs

#6 - 4/0 AWG Solid and Stranded Copper



Features & Benefits

- Color coded for easy identification
- Chamfered end
- Made of copper alloy, tin plated for corrosion resistance and RoHS compliance
- Not UL Listed but tested and met UL486A-486B pullout requirements

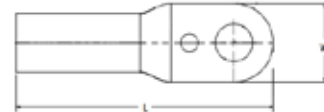

Catalog Number	Wire Range	Stud Size	Dimensions		Bulk Catalog Number	Conn. Color Code	Installation Tooling			Color Code (Die)	Die Index	Strip Length
			L	W			MD6, MD734R, 500, 600 Series	35, 750 Series	Dieless (# Crimps)			
YAGB6CLTC10FX	#6	#10	1.46"	0.44"	YAGB6CLTC10FXOEM	Blue	W5CVT (1) W5CRT (1)	U5CRT (1)	81K Series (1) 4PC Series (1) MY2911 (1) MRC840 (1)	Blue	7	7/8"
YAGB6CLTC14FX		1/4"			YAGB6CLTC14FXOEM							
YAGB6CLTC516FX		5/16"	1.61"	0.60"	YAGB6CLTC516FXOEM							
YAGB6CLTC38FX		3/8"	YAGB6CLTC38FXOEM									
YAGB6CLTC12FX		1/2"	1.73"	0.74"	YAGB6CLTC12FXOEM							
YAGB4CLTC10FX	#4	#10	1.97"	0.75"	YAGB4CLTC10FXOEM	Gray	W4CVT (1) W4CRT (1)	U4CRT (1)	81K Series (1) 4PC Series (1) 644 Series (1) MY2911 (1) MRC840 (1)	Gray	6	15/16"
YAGB4CLTC14FX		1/4"			YAGB4CLTC14FXOEM							
YAGB4CLTC516FX		5/16"			YAGB4CLTC516FXOEM							
YAGB4CLTC38FX		3/8"			YAGB4CLTC38FXOEM							
YAGB4CLTC12FX		1/2"			YAGB4CLTC12FXOEM							
YAGB2CLTC10FX	#2	#10	2.09"	0.81"	YAGB2CLTC10FXOEM	Green	W2CVT (1) W2CRT (1)	U2CRT (1)	81K Series (1) 4PC Series (1) 644 Series (1) MY2911 (1) MRC840 (1)	Brown	10	15/16"
YAGB2CLTC14FX		1/4"			YAGB2CLTC14FXOEM							
YAGB2CLTC516FX		5/16"			YAGB2CLTC516FXOEM							
YAGB2CLTC38FX		3/8"			YAGB2CLTC38FXOEM							
YAGB2CLTC12FX		1/2"			YAGB2CLTC12FXOEM							
YAGB25LTC14FX	1/0	1/4"	2.40"	0.87"	YAGB25LTC14FXOEM	Black	W25VT (1) W25RT (1)	U25RT (1)		Pink	12	
YAGB25LTC516FX		5/16"			YAGB25LTC516FXOEM							
YAGB25LTC38FX		3/8"			YAGB25LTC38FXOEM							
YAGB25LTC12FX		1/2"			YAGB25LTC12FXOEM							
YAGB26LTC14FX	2/0	1/4"	2.44"	0.91"	YAGB26LTC14FXOEM	Orange	W26VT (1) W26RT (1)	U26RT (1)	81K Series (1) 4PC Series (1) 644 Series (1) MY2911 (1) MRC840 (2)	Black	13	1-3/16"
YAGB26LTC516FX		5/16"			YAGB26LTC516FXOEM							
YAGB26LTC38FX		3/8"			YAGB26LTC38FXOEM							
YAGB26LTC12FX		1/2"			YAGB26LTC12FXOEM							
YAGB28LTC14FX	4/0	1/4"	2.56"	1.10"	YAGB28LTC14FXOEM	Yellow	W28VT (1) W28RT (1)	U28RT (1)		Purple	15	
YAGB28LTC516FX		5/16"			YAGB28LTC516FXOEM							
YAGB28LTC38FX		3/8"			YAGB28LTC38FXOEM							
YAGB28LTC12FX		1/2"			YAGB28LTC12FXOEM							

Compression Connections

This page left intentionally blank.

Table of Contents

Clear Cold Shrink.....D-2
 Type CCSC, Silicone Rubber

Cold Seal Splice Kits.....D-3
 Type CSB, Low-Voltage Conductor
 Type CSJ, with mastic seal

Types CSEC Cold Shrink End Caps
 D-4

Overview Cold Shrink Terminal
D-5

Medium Voltage Cold Shrink Kits
 Type CSGO.....D-6
 Type CSUDO-J.....D-7
 Type CS3CO-B.....D-8
 Type CS3CI-J.....D-9

Medium Voltage Cold Shrink Accessories
 Type BCFS.....D-10
 Type BMESH.....D-10
 Type BRAID-GA.....D-10
 Type 290-SEALANTS.....D-11
 Type CS-TAPE.....D-11
 Type BCPK.....D-12
 Type BCFGK.....D-12

Thin Wall Heat Shrink Tubing
 Type HS-T-PF, 6" Lengths.....D-13
 Type HS-T-PF, 4' Reels.....D-14
 Type HS-T-PF, 25' Reels.....D-15

Heavy Wall Heat Shrink Tubing
 Type HS-H-PF.....D-16

Clear VISI-SHRINK™ Heat Shrink Tubing
 Type HSC-FR.....D-17

Thin Wall Heat Shrink Tubing,
 Flame Retardant
 Type HS-FR.....D-18

Heavy Wall Heat Shrinkable End Caps
 Flame Retardant
 Type HSIC-FR.....D-19



Most frequently ordered catalog numbers are highlighted in BLUE

Shrink Tubing

Clear Cold Shrink
Silicone Rubber

TYPE CCSC

Clear Cold Shrink

Material: Silicone Rubber



2000 Volts
Operating Temperature 90° C

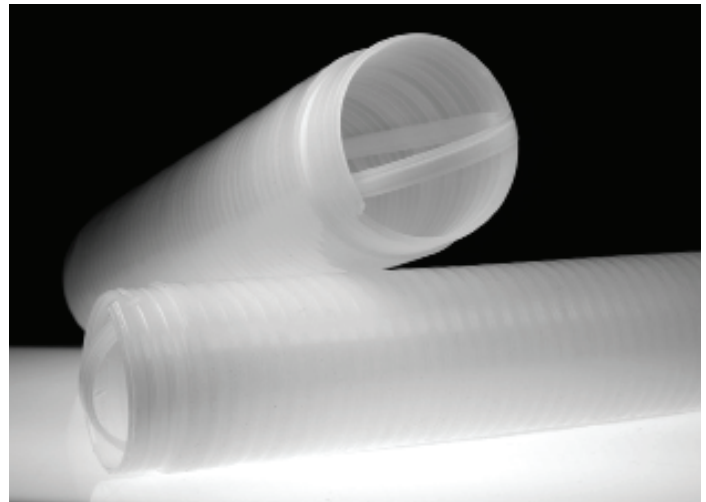

Clear Cold Shrink tubing provides a clear way to inspect connections after installation. The clear cold shrink tubing allows inspectors to verify die index embossments on compression connections. No installation tools required.

Features and Benefits

- Length of tube is consistent before and after application
- Clear shrink tube for inspection purposes
 - Verify BURNDY die embossment
 - Verify correct number of crimps
 - Verify location of crimps
 - Verify proper strip length with no wire exposed
- Rip and Grip! Does not require heat gun or any installation tools
- Passes TELCORDIA GR-347-CORE Abrasion and Cut Test up to 750 kmil
- cULus insulating cover for wire connectors tested in accordance to UL 486A/B
- Passes UL 746C Glow Wire Test
- Ripcord is recyclable

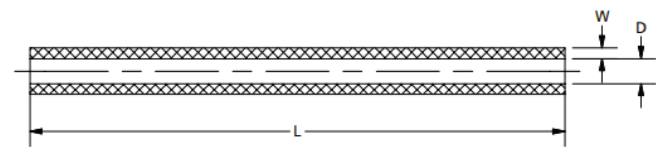

AFTER SHRUNK

Clear Cold Shrink Catalog Number	ID Before Shrink	Jacket O.D. Range	W	D	Cold Shrink Tube Length
CCSC110600	1.10	0.39" - 0.80"	.12	.28	5.91
CCSC110800	1.10	0.39" - 0.80"	.12	.28	7.99
CCSC126600	1.26	0.56" - 0.90"	.09	.49	5.91
CCSC126900	1.26	0.56" - 0.90"	.09	.49	9.02
CCSC146600	1.46	0.70" - 1.05"	.10	.63	5.91
CCSC146900	1.46	0.70" - 1.05"	.10	.63	9.02
CCSC200600	2.09	0.90" - 1.28"	.12	.75	5.91
CCSC200900	2.09	0.90" - 1.28"	.12	.75	9.02
CCSC2001200	2.09	0.90" - 1.28"	.12	.75	12.01
CCSC25600	2.56	1.22" - 2.01"	.12	1.10	5.91
CCSC25900	2.56	1.22" - 2.01"	.12	1.10	9.02
CCSC251200	2.56	1.22" - 2.01"	.12	1.10	12.01

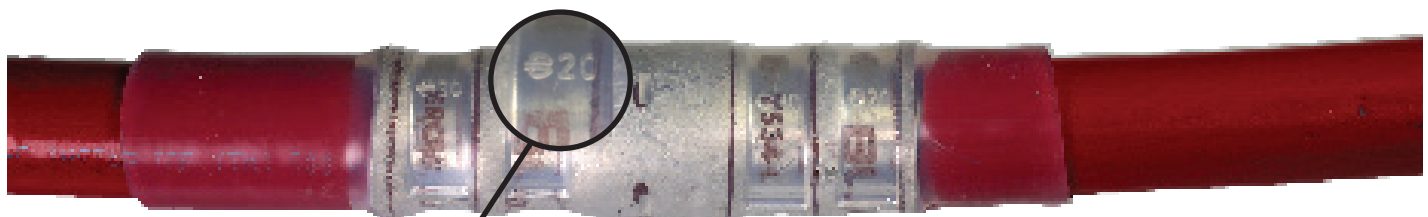

Inspectability to verify correct tool/die combination

TYPES CSB, CSJ

Cold Seal Splice Kits

These cold applied splice sealing products are made of specially formulated silicone rubber and offer excellent insulation and moisture proof sealing for in-line cable connector systems or elbow to cable jacket applications. The rubber sleeves are factory expanded and held over a removable, plastic rip core housing. Installs quickly and easily. Type CSJ also includes a mastic seal. Operating temperature range: -40°C to 105°C. Meets ANSI C119.1-1986.



Features and Benefits

- Easy, safe installation
- Suitable for a wide range of cable sizes
- UV resistance, thermal stability
- No special tools or training required
- Forms a moisture proof seal
- Superior, time-saving insulation technology
- Indoor and outdoor applications

In-Line Splice Sealing Kits Type CSB - Low Voltage conductor only

Catalog Number	Conductor Range	Application Range (min-max diameter)	Supplied Tube Length	Relaxed Tube Length
CSB037800SR1	#2 - 1/0	0.37" - 0.84"	6.50"	8.00"
CSB051900SR1	2/0 - 400	0.51" - 1.18"	7.50"	9.00"
CSB097900SR1	500 - 800	0.97" - 1.95"	7.50"	9.00"
CSB0971200SR1	500 - 800	0.97" - 1.95"	10.50"	12.00"
CSB125900SR1	900 - 1000	1.25" - 2.65"	7.50"	9.00"
CSB163900SR1	1250 - 2000	1.63" - 3.67"	7.50"	9.00"

Cable Jacket Sealing Kits Type CSJ (includes mastic seal)

Catalog Number	Application Range (min-max diameter)	Supplied Tube Length	Relaxed Tube Length
CSJB097600SR1	0.97" - 1.95"	4.50"	6.00"
CSJB125800SR1	1.25" - 2.65"	6.50"	8.00"
CSJB163900SR1	1.63" - 3.67"	7.50"	9.00"

Types CSEC

Cold Shrink End Caps

These cold applied end cap sealing products are made of specially formulated EPDM Rubber (Ethylene Propylene Diene Monomer) providing excellent moisture, acids, alkalis and weather resistance. End Caps provide a constant pressure on the conductor to contract and expand as needed along with the cable. The rubber end caps are factory expanded and applied over a removable plastic rip core housing. Installs quickly and easily with no tools needed. Operating temperature range: -40°C to 105°C. Meets ANSI C119.1-2011.



Features and Benefits

- Easy, safe installation
- Resists abrasive conditions
- Suitable for a wide range of cable sizes
- UV Resistance, thermal stability
- No special tools or training required
- Water resistant
- No heat or torches required
- Superior, time-saving insulation technology
- Resists acids and alkalis
- Indoor and Outdoor applications
- No training required for installation
- Easily removed with a utility knife

Cold shrink end caps type CSEC - Low Voltage Conductor only.

Catalog Number	Conductor Range	Cord ID	Application Range (min-max diameter)	Pre -Shrunk Length	After-Shrunk Thickness	Qty Per Bag
CSEC1	#2 - 4/0	0.98"	0.46" [11.6] - 0.82" [20.9]	2.08" [52.8]	.098"	6
CSEC2	4/0 - 400	1.38"	0.63" [15.9] - 1.18" [30.1]	2.50" [63.5]	.118"	6
CSEC3	500 - 1250	2.17"	1.02" [26.0] - 1.94" [49.2]	2.25" [57.2]	.138"	3
CSEC4	1500 - 2000	3.54"	1.79" [45.5] - 3.32" [84.3]	2.50" [63.5]	.138"	3

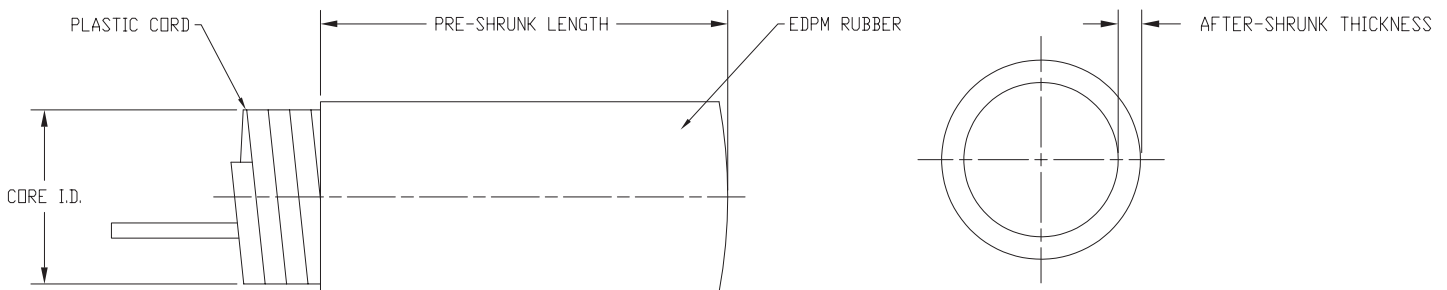

Simplifying Performance with Serious Engineering

BURNDY® HYSEAL integrated, all-in-one design ushers in a new era of medium voltage cable termination with reliability, efficiency, safety and performance.

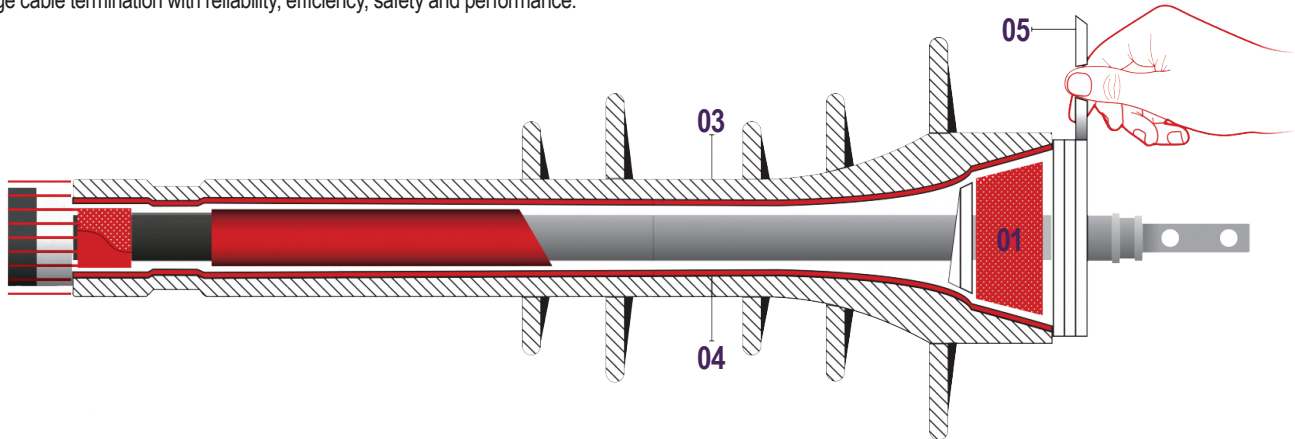

Built-in Endseal Mastic (01)

Installed at both ends of the termination, high-performance mastic is applied at the top and bottom of the installation to help streamline installation and operation.

HYZINC Stress-Grading Mastic (02)

Greater surface coverage of our proprietary Zinc-Oxide (ZnO) formulation fills voids between the rubber body and cable substrate to deliver exceptional discharge and impulse performance. This helps mitigate issues surrounding poor cable prep - the most common cause of cable failures.

Durable Silicone Rubber Body (03)

The BURNDY® HYSEAL body is tough enough for any industrial or utility environment. Engineered to be both UV-resistant and hydrophobic, the body helps prevent moisture and airborne contaminant acculation to maintain surface resistivity and resist current leakage.

Silicone Cold Shrink Jacket (04)

Protecting the system for indoor or outdoor work, the HYSEAL silicone cold shrink jacket means reliable system installation without the skilled manpower demands or risk that comes with applied heat - not to mention the hot-work permits.

Single Spiral Ripcord (05)

Anyone can install the HYSEAL Medium Voltage Cable Termination. One reason? The system features an enhanced spiral ripcord design using smooth edges that make unwinding during the installation much easier on all types of cable. The ripcord pulls in seconds, securing the unit for solid, stable installation no matter what the operating environment.

HYZINC: The Key to Superior Stress Management

HYSEAL is the only medium voltage cable termination that uses HYZINC - a proprietary Zinc-Oxide (ZnO) silicone technology that controls electrical stress more efficiently and delivers smoother potential distribution. HYZINC is a stress-grading mastic that is applied at the semi-conductive cut-back area (in direct contact with the semi-conductive shield). Its non-linear, resistive-field grading design is based on ZnO microvaristors that can be "tuned" to a certain switching voltage. It's made by mixing ZnO particles with an inert carrier to make a "flowable" material with the ZnO electrical properties. The result? Potential distribution that's more linear for better overall system performance.

TYPE CSGO

Medium Voltage Cold Shrink Termination Kits Indoor/Outdoor Industrial Series Applications up to 35kV

To be used with Single Shielded Conductor, XLPE and EPR copper tape, drain wire shield, single shield or lead sheathed power cables for the Electrical/Industrial/Construction market.

Burndy CSGO Kit Series contains (3) one-piece, Skirted (Indoor/Outdoor) silicone rubber terminations that meet IEEE Standard 48 Class 1 for indoor and weather-protected applications. These kits are designed for terminating solid dielectric shielded power cables rated 5–35 kV.

Material: Silicone Rubber

Cold shrink cable terminations provide a quick, easy, safe and cost effective installation. No installation tools required, spiral rip cord design unwinds easily and enables quick removal of the hold-out core. Type CSGO series suitable for Indoor/Outdoor Industrial applications. Conforms to IEEE-48-1996, Class 1 and ISO/IEC 17025 Standards. Test reports available upon request.

Each kit contains sufficient quantities of material to make three terminations.

Kit Contents:

- (3) Silicon Rubber Terminations
- (3) Ground Straps
- (3) Copper Foil Tape
- (3) Constant Force Springs
- (1) Roll of PVC Tape
- (3) Mastic Strips
- (3) Cable Prep Kits
- (1) Instruction Manual



CSGO Series
Shown with BURNDY terminal lug

Features and Benefits

- Quick, consistent and easy to install
- Incorporates sealants at bottom and top of termination, saving time and effort during installation
- Unique stress control system based on microvaristor (ZnO) technology that delivers exceptional discharge and impulse performance
- More craft friendly and greater installation efficiency for easier training of field crew
- Two less steps on Shielded cable and three less steps on JCN cable versus leading competitor lowering total installed cost
- Length of tube is consistent before and after application
- Spiral rip cord design provides for easy installation with effortless unwinding providing for fast removal of the hold-out core; Rip cord is recyclable
- Insulation Level: 100%, 133%
- Variations available such as kit supplied with terminal or pin connector; customer would crimp onto conductor during installation (terminal/pin connector do require proper installation tooling)

Outdoor (Skirted) Catalog Number	Rip Cord I.D.	Length (preshrink)	Cable Insulation Outside Diameter Range	Insul. Dia. (preshrink)	5-8kV Wire Range	15kV Wire Range	25-28kV Wire Range	35kV Wire Range
CSGO15210	1.62	9.09	0.57 - 0.90	1.10	1/0 - 4/0 AWG	#2 - 1/0 AWG	—	—
CSGO2528140	2.04	12.60	0.71 - 1.26	1.50	4/0 - 500 kcmil	1/0 - 250 kcmil	#2 - 4/0 AWG	—
CSGO252810250	2.17	14.17	0.83 - 1.34	1.65	350 - 750 kcmil	4/0 - 500 kcmil	1/0 - 250 kcmil	—
CSGO3550015	3.59	20.87	1.04 - 1.63	1.97	750 - 1000 kcmil	350 - 750 kcmil	250 - 500 kcmil	1/0 - 350 kcmil
CSGO355001500	3.59	20.87	1.34 - 2.32	2.83	1000 - 2000 kcmil	750 - 2000 kcmil	500 - 1500 kcmil	350 - 1500 kcmil

TYPE CSUDO-J

Medium Voltage Cold Shrink Termination Kits Renewable Series - Jacketed Concentric Neutral Sleeve Only Applications up to 35kV

To be used with single core XLPE and EPR concentric neutral underground distribution cables commonly found in the renewables and utility markets.

Material: Silicone Rubber

Type CSUDO-J (for indoor/outdoor jacketed applications) Series of Jacketed Concentric Neutral Termination Kits.

Termination kits feature a geometric stress cone for exceptional performance. Kit includes cold shrink termination, center endseal termination, and installation guide. Conforms to IEEE-48-2009, Class 1 and ISO/IEC 17025 Standards. Test reports available upon request.

Kit Contents:

- (1) Silicone Rubber Termination
- (1) Red Sealant Mastic
- (1) Roll of PVC Tape
- (1) Cable Prep Kit
- (1) Instruction Manual
- (1) Cutback Template



Features and Benefits

- All-in-one integrated body incorporating stress control and sealant mastics
- Unique stress control system based on microvaristor (ZnO) technology that delivers exceptional discharge and impulse performance
- Quick and easy installation. Offering fewest number of steps to install
- Improved spiral rip core assembly uses smooth edges for simpler installation with less effort. Heat tacked spiral core prevents unravelling during shipping and handling
- Excellent UV Resistance and hydrophobic characteristics
- Silicone rubber body provides excellent track and erosion resistance

(Jacketed) Outdoor (Skirted) Catalog Number	Rip Cord I.D.	Length (preshrink)	Cable Insulation Outside Diameter Range	Insul. Dia. (preshrink)	5-8kV Wire Range	15kV Wire Range	25-28kV Wire Range	35kV Wire Range
CSUDO15210J	1.62	9.25	0.57 - 0.90	1.10	#2 - 4/0 AWG	#2 - 1/0 AWG	—	—
CSUDO2528140J	2.04	12.60	0.71 - 1.26	1.50	4/0 - 500 kcmil	1/0 - 250 kcmil	#1 - 4/0 AWG	—
CSUDO252810250J	2.17	14.17	0.83 - 1.34	1.65	350 - 750 kcmil	4/0 - 500 kcmil	1/0 - 250 kcmil	—
CSUDO3510350J	3.53	20.87	1.04 - 1.63	1.97	750 - 1000 kcmil	350 - 750 kcmil	250 - 500 kcmil	1/0 - 350 kcmil
CSUDO355001500J	3.53	20.87	1.34-2.32	2.87	1000 - 2000 kcmil	750 - 2000 kcmil	500 - 1500 kcmil	500 - 1500 kcmil

TYPE CS3CO-B

Cold Shrink Medium Voltage Termination Kits 3 Conductor Conversion Series - Indoor/Outdoor Sleeves with Boot Applications up to 35kV Applications

To be used with BURNDY® Single Conductor Terminations on Three-Conductor Cables, for 35kV applications. (Terminations sold separately.)

Material: Silicone Rubber

The Type CS3CO-B Series of 3 Conductor Conversion Kits with Breakout Boot are designed to be used with single conductor, Indoor and Outdoor Cable Accessories on three-conductor (3/C) cables. The Breakout Kit is easy and quick to install, even in confined spaces - with no special tools, torch/flame or hot permits required. The BURNDY® Type CS3CO-B series with breakout boot conforms to IEEE-48-2009, Class 1 and ISO/IEC 17025 Standards. Test reports available upon request. Please order one kit per three conductor cable application.

Kit Contents:

- (1) Cold Shrink Silicon Rubber Breakout Boot
- (4) Strips of Mastic Tape
- (3) Silicone Rubber Re-jacketing Sleeves
- (1) Long Tail Tinned Copper Ground Braid with Solder Block
(for Armored Cable Only)
- (1) Large Constant Force Spring
- (1) Roll Black Electrical Tape
- (1) Roll Electrical Shielding (Mesh) Tape
- (1) Cable Tie
- (1) Cable Prep Kit
- (1) Instruction Manual



* Shown with Termination Kit

Features and Benefits

- Grip and Rip! Does not require heat gun or any installation tools
- Spiral rip cord design provides for easy installation with effortless unwinding providing for fast removal of the hold-out core; Rip cord is recyclable
- All kits supplied with cold shrinkable tube (unprinted), 3-leg boot, seal, cable tie, and installation guide
- Quick, easy, cost effective installation utilizing one-piece terminator design

Outdoor Breakout Kit Catalog Number	3C Truck Cable OD Max	Insulation Shield Dia. Range	5-8kV Wire Range	15kV Wire Range	25-28kV Wire Range	35kV Wire Range
CS3CO58220B	2.58"	0.61" - 0.96"	#2 - 250 kcmil	#2 - 1 AWG	—	—
CS3CO5820350B	2.58"	0.72" - 1.10"	#1 - 350 kcmil	#2 - 3/0 AWG	—	—
CS3CO2528140B	3.50"	0.80" - 1.27"	2/0 - 500 kcmil	2/0 - 250 kcmil	#1 - 2/0 AWG	—
CS3CO2528250500B	4.30"	1.10" - 1.52"	350 - 750 kcmil	250 - 500 kcmil	#1 - 350 kcmil	1/0 - 3/0 AWG
CS3CO2835250500B	4.42"	1.33" - 1.75"	500 - 1000 kcmil	500 - 750 kcmil	4/0 - 500 kcmil	1/0 - 350 kcmil

* The wire ranges for this table are based on 100% insulation level and are to be used as a guide. Please use Insulation Shield Dia. Range data and match up with specific Cable Manufacturer's specifications to ensure accessory is sized properly as wire ranges may be different based on Cable Manufacturer's specifications.

TYPE CS3CI-J

Medium Voltage Cold Shrink Termination Kits 3 Conductor Conversion Series - Indoor Sleeves without Boot Applications up to 35kV Applications

Designed to be used with BURNDY® Single Conductor Terminations on Three-Conductor Cables, for 5-35kV applications. (Terminations sold separately.)

Material: Silicone Rubber

The Type CS3CI-J Series of 3 Conductor Conversion Kits with Indoor Sleeves without Boot Conductor. Conversion kits includes cold shrinkable tube (unprinted), seal, cable tie, and installation guide. Conforms to IEEE-48-2009, Class 1 and ISO/IEC 17025 Standards. Test reports available upon request.



* Shown with Termination Kit

Kit Contents:

- (4) Strips of Mastic Tape
- (3) Silicone Rubber Re-jacketing Sleeves
- (1) Long Tail Tinned Copper Ground Braid with Solder Block
(for Armored Cable Only)
- (1) Constant Force Spring
- (1) Roll Black Electrical Tape
- (1) Roll Electrical Shielding (Mesh) Tape
- (1) Cable Tie
- (1) Cable Prep Kit
- (1) Instruction Manual

Features and Benefits

- Grip and Rip! Does not require heat gun or any installation tools
- Spiral rip cord design provides for easy installation with effortless unwinding providing for fast removal of the hold-out core; Rip cord is recyclable
- All kits supplied with cold shrinkable tube (unprinted), seal, cable tie, and installation guide
- Quick, easy, cost effective installation utilizing one-piece terminator design

Indoor Catalog Number	Insulation Shield Dia. Range	5-8kV Wire Range	15kV Wire Range	25-28kV Wire Range	35kV Wire Range
CS3CI58220J	0.61" - 0.96"	#2 - 250 kcmil	#2 - 1 AWG	—	—
CS3CI5820350J	0.72" - 1.10"	#1 - 350 kcmil	#2 - 3/0 AWG	—	—
CS3CI2528140J	0.80" - 1.27"	2/0 - 500 kcmil	2/0 - 250 kcmil	#1 - 2/0 AWG	—
CS3CI2528250500J	1.10" - 1.52"	350 - 750 kcmil	250 - 500 kcmil	#1 - 350 kcmil	1/0 - 3/0 AWG
CS3CI2835250500J	1.33" - 1.75"	500 - 1000 kcmil	500 - 750 kcmil	4/0 - 500 kcmil	1/0 - 350 kcmil

* The wire ranges for this table are based on 100% insulation level and are to be used as a guide. Please use Insulation Shield Dia. Range data and match up with specific Cable Manufacturer's specifications to ensure accessory is sized properly as wire ranges may be different based on Cable Manufacturer's specifications.

TYPE BCFS

Constant Force Springs for securing solder-sealed ground braids in termination and splice kits

The Type BCFS Constant Force Springs are for use in grounding and earthing applications and suitable for use on lead and aluminum cable sheaths, steel or aluminum armor cables. Easy application by rolling onto core or outside diameter creating radial pressure.



Catalog Number	I.D.	Width	Length
SPRING-CFS0405 .47"	.47"	.50"	18"
SPRING-CFS0605 .56"	.52"	.50"	24"
SPRING CFS1005-1.03"	1.03"	.50"	30"

TYPE BMESH

Tinned Copper Shielding Mesh

The Type BMESH Tinned Copper Shielding Mesh provides continuity of shielded power cables in termination kits.



Catalog Number	Width	Length
BMESH2015	2.25"	15'

TYPE BRAID-GA

Solder Blocked Braid

The Type BRAID-GA for ground or earth cable terminations provide a continuous ground for power cable shielding termination kits. Ideal for grounding shielded cable and accessories. Made of tin plated copper, compatible with common solvents, adhesives and cable oils.



Catalog Number	Conductor Equiv.	Width	Length
BRAID GA 8 SLDR BLOCKED 16"	#8	.50"	16"
BRAID GA 6 SLDR BLOCKED 16"	#6	.75"	16"
BRAID GA 4 SLDR BLOCKED 16"	#4	1"	16"

TYPE 290-SEALANTS

The Type 290-SEALANTS offer excellent adhesion and sealing characteristics to metals, rubbers, synthetic cable insulations and jackets. Type 290-SEALANTS also provide UV resistance and are designed for outdoor conditions and sealing out moisture.

Catalog Number	Size	Width	Length
290-SEALANTS13	0, 1, 2	20mm	155mm
290-SEALANTS14	3, 4	20mm	200mm
290-SEALANTS15	5	20mm	241mm
290-SEALANTS23	0, 1, 2	25mm	5" / 120mm
290-SEALANTS24	3, 4	25mm	6" / 150mm
290-SEALANTS25	5	25mm	210mm



TYPE CS-TAPE

CS34BLKTAPE is a premium grade, 8.5 mil, all-weather vinyl tape used for insulating electrical terminations or splices on high voltage repairs or cable harnesses. CS34BLKTAPE is lead free and flame retardant. Manufactured with a polymeric backing construction as well as a specialized method of bonding the adhesive to the vinyl backing, creating a highly conformable tape that delivers a moisture-tight seal in temperatures ranging from 0° F to 220° F.

CS34REDTAPE is professional grade, 7.0 mil, all-weather vinyl tape used for color-coding and phase identification in electrical applications in temperatures ranging from 0° F to 220° F. CS34REDTAP colored electrical tape is lead free and flame retardant. Manufactured with a polymeric backing construction as well as a specialized method of bonding the adhesive to the vinyl backing, creating a highly conformable tape that delivers a moisture-tight seal, even in extreme temperatures.



Catalog Number	Width	Length
CS34BLKTAPE	3/4"	60'
CS34REDTAPE	3/4"	60'

TYPE BCPK

**Multi-purpose solvent wipes;
Abrasive paper**

Type BCPK kit includes Solvent and Dry Wipes, and Abrasive Paper for the cleaning and preparation of electrical wires, terminations, and equipment. Available as single of each item or package with 3 of each.

Catalog Number	Qty of each	Contents
BCPK0306	3	Solvent Wipes Dry Wipes
BCPK0102	1	Strips of Abrasive Paper



TYPE BCFGK

**Kit with Constant Force Spring, Copper Foil Tape,
and 36" long Tinned Copper Braid**

The Type BCFGK kit for grounding or earthing cables in the Medium Voltage Termination kits. Includes: Braid to be applied directly to the conductor, constant force spring to apply pressure to the ground braid and conductor, and copper foil to be applied to copper tape shield.

Catalog Number	Qty of each	Contents
BCFGK1X36	1	Constant Force Spring, Copper Foil Tape, #8 Tinned Copper Braid 36"
BCFGK2X36	1	Constant Force Spring, Copper Foil Tape, #6 Tinned Copper Braid 36"
BCFGK3X36	1	Constant Force Spring, Copper Foil Tape, #4 Tinned Copper Braid 36"



TYPE HS-T-PF

Thin Wall Heat Shrink Tubing, 6 Inch Lengths

Type HS-T-PF is a flexible thin wall, flame retardant heat shrink tubing made of cross-linked polyolefin. The 2:1 shrink ratio allows for faster shrink recovery, covering wire sizes: #18 AWG to 300 kcmil. Operating temperatures from -55° C to 135° C with a shrink temperature of 120° C.



Meets SAE-AMS-DTL-23053/5 600 V

Catalog Number	Nominal Diameter Inches	Min. Exp. I.D. In.	Max. Recov. I.D. In.	Nom. Wall Thickness In.	Conductor Range	Pieces per Package	
						# Pieces Black	# Pieces Each Color
HSM116T6PF26	1/16	0.06	0.03	0.02	#18	8	3
HSB116T6PF26	1/16	0.06	0.03	0.02	#18	26	0
HSM332T6PF24	3/32	0.09	0.05	0.02	#18-16	6	3
HSB332T6PF24	3/32	0.09	0.05	0.02	#18-16	24	0
HSM18T6PF20	1/8	0.12	0.06	0.02	#18-14	2	3
HSB18T6PF20	1/8	0.12	0.06	0.02	#18-14	20	0
HSM316T6PF18	3/16	0.19	0.09	0.02	#18-12	6	2
HSB316T6PF18	3/16	0.19	0.09	0.02	#18-12	18	0
HSM14T6PF14	1/4	0.25	0.12	0.18	#14-10	2	2
HSB14T6PF14	1/4	0.25	0.12	0.18	#14-10	14	0
HSM38T6PF12	3/8	0.38	0.19	0.02	#8-6	6	1
HSB38T6PF12	3/8	0.38	0.19	0.02	#8-6	12	0
HSM12T6PF10	1/2	0.50	0.12	0.02	#6-2	4	1
HSB12T6PF10	1/2	0.50	0.12	0.02	#6-2	10	0
HSM34T6PF8	3/4	0.75	0.38	0.02	#1-3/0	2	1
HSB34T6PF8	3/4	0.75	0.38	0.02	#1-3/0	8	0
HSM100T6PF7	1	1.00	0.50	0.18	2/0-300	1	1
HSB100T6PF7	1	1.00	0.50	0.18	2/0-300	7	0

HSB series — all black

HSM series — multiple colors: black, blue, clear, green, red, white, yellow

HSB11612T6PF14	1/16, 3/32, 1/8, 3/16, 1/4, 3/8, 1/2	—	—	14	0
HSB38100T6PF8	3/8, 1/2, 3/4, 1"	—	—	8	0

Multiple diameter packages contain two pieces of each size listed: Black only.

TYPE HS-T-PF

Thin Wall Heat Shrink Tubing, 4 Foot Reels

Type HS-T-PF is a flexible thin wall, flame retardant heat shrink tubing made of cross-linked polyolefin. The 2:1 shrink ratio allows for faster shrink recovery, covering wire sizes: #18 AWG to 300 kcmil. Operating temperatures from -55° C to 135° C with a shrink temperature of 120° C.



Meets SAE-AMS-DTL-23053/5 600 V

Specify Color Code in Third Position of Catalog Number:

Example: HSC316T48PF

- B : BLACK
- BL: BLUE
- C : CLEAR
- G : GREEN
- R : RED
- W : WHITE
- Y : YELLOW

Catalog Number	Nominal Diameter Inches	Min. Exp. I.D. In.	Max. Recov. I.D. In.	Nom. Wall Thickness In.	Conductor Range
HS_116T48PF	1/16	0.06	0.03	0.018	#18
HS_332T48PF	3/32	0.09	0.05	0.020	#18 - 16
HS_18T48PF	1/8	0.12	0.06	0.020	#18 - 14
HS_316T48PF	3/16	0.19	0.09	0.020	#18 - 12
HS_14T48PF	1/4	0.25	0.12	0.180	#14 - 10
HS_38T48PF	3/8	0.38	0.19	0.020	#8 - 6
HS_12T48PF	1/2	0.50	0.12	0.020	#6 - 2
HS_34T48PF	3/4	0.75	0.38	0.020	#1 - 3/0
HS_100T48PF	1	1.00	0.50	0.180	2/0 - 300
HS_150T48PF	1-1/2	1.50	0.75	0.180	250 - 500
HS_200T48PF	2	2.00	1.00	0.180	350 - 750

TYPE HS-T-PF

Thin Wall Heat Shrink Tubing, 25 Foot Reels

Type HS-T-PF is a flexible thin wall, flame retardant heat shrink tubing made of cross-linked polyolefin. The 2:1 shrink ratio allows for faster shrink recovery, covering wire sizes: #18 AWG to 300 kcmil. Operating temperatures from -55° C to 135° C with a shrink temperature of 120° C.

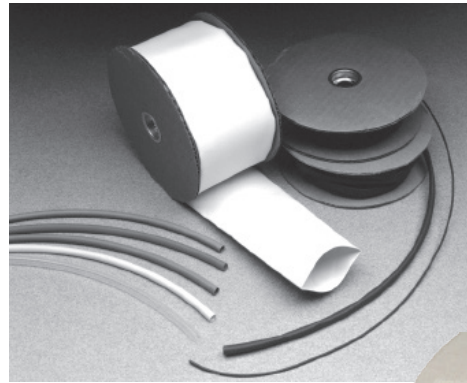

Meets SAE-AMS-DTL-23053/5 600 V



Specify Color Code in Third Position of Catalog Number:

Example: HSC116T300PF

- B** : BLACK
- BL**: BLUE
- C** : CLEAR
- G** : GREEN
- R** : RED
- W** : WHITE
- Y** : YELLOW

Catalog Number	Nominal Diameter Inches	Min. Exp. I.D. In.	Max. Recov. I.D. In.	Nom. Wall Thickness In.	Conductor Range
HS_116T300PF	1/16	0.06	0.03	0.018	#18
HS_332T300PF	3/32	0.09	0.05	0.020	#18 - 16
HS_18T300PF	1/8	0.12	0.06	0.020	#18 - 14
HS_316T300PF	3/16	0.19	0.09	0.020	#18 - 12
HS_14T300PF	1/4	0.25	0.12	0.180	#14 - 10
HS_38T300PF	3/8	0.38	0.19	0.020	#8 - 6
HS_12T300PF	1/2	0.50	0.12	0.020	#6 - 2
HS_34T300PF	3/4	0.75	0.38	0.020	#1 - 3/0
HS_100T300PF	1	1.00	0.50	0.180	2/0 - 300

TYPE HS-H-PF

Heavy Wall Heat Shrink Tubing, Cut Lengths and 4 Foot Sticks



Type HS-H-PF is a heavy wall, heat shrink tubing made of cross-linked polyolefin. The shrink ratio is 3:1, and the inside diameter is coated with an adhesive sealant to protect against moisture and corrosion. UL486D Listed for direct burial applications. Accommodates #14 AWG - 500 kcmil conductors. Operating temperatures from -55° C to 135° C with a shrink temperature of 120° C.

Meets SAE-AMS-DTL-23053/5 600 V



Catalog Number	Length	Nominal Diameter Inches	Min. Exp. I.D. In.	Max. Recov. I.D. In.	Nom. Wall Thickness In.	Conductor Range	Number of Pcs. Per Package
HSB35H3PF25	3"	0.35	0.35	0.15	0.07	#14-10	25
HSB35H6PF25	6"	0.35	0.35	0.15	0.07	#14-10	25
HSB35H48PF5	4'	0.35	0.35	0.15	0.07	#14-10	5
HSB34H6PF10	6"	0.75	0.75	0.22	0.09	#6-2	10
HSB34H9PF10	9"	0.75	0.75	0.22	0.09	#6-2	10
HSB34H48PF5	4'	0.75	0.75	0.22	0.09	#6-2	5
HSB110H6PF5	6"	1.10	1.10	0.40	0.12	#1-3/0	5
HSB110H9PF5	9"	1.10	1.10	0.40	0.12	#1-3/0	5
HSB110H48PF5	4'	1.10	1.10	0.40	0.12	#1-3/0	5
HSB150H9PF3	9"	1.50	1.50	0.50	0.16	2/0-350	3
HSB150H12PF3	12"	1.50	1.50	0.50	0.16	2/0-350	3
HSB150H48PF5	4'	1.50	1.50	0.50	0.16	2/0-350	5
HSB200H9PF2	9"	2.00	2.00	0.75	0.16	250-500	2
HSB200H12PF2	12"	2.00	2.00	0.75	0.16	250-500	2
HSB200H48PF2	4'	2.00	2.00	0.75	0.16	250-500	2

Available in black only.

TYPE HSC-FR

VISI-SHRINK™ Fire Retardant Clear Heat Shrink Tubing

UL Recognized to 600V

Type HSC-FR is a flexible polyvinyl chloride clear heat-shrink tubing. Excellent flame retardant properties and a 2:1 shrink ratio, the VISI-SHRINK tubing enables inspectors to read die index embossments on installed connectors easily. UL Recognized, 105° C, 600V, the operating temperature from -20° C to 105° C with a shrink temperature of 135° C.



Features and Benefits

- UL 224, VW-1 Rated, self-extinguishing flame retardant properties
- Clear tubing allows inspection of die index embossment and shiner after installation is complete; should any corrosion occur it will be visible during inspection
- Low shrink temperature only requires common hot air guns to apply
- Meets MIL-M-23053/Z-206C

Catalog Number	I.D. Expanded	I.D. After Recovery	Wall Thickness	Conductor Range		Standard Reel Size (Feet)
				Code	Flex	
HSC18FR	0.13	0.06	0.03	#16-#14	#16-#14	50
HSC18FR250	0.13	0.06	0.03	#16-#14	#16-#14	250
HSC14FR	0.25	0.13	0.03	#12-#8	#12-#10	50
HSC14FR250	0.25	0.13	0.03	#12-#8	#12-#10	250
HSC38FR	0.38	0.19	0.03	#6-#4	#8-#6	50
HSC38FR250	0.38	0.19	0.03	#6-#4	#8-#6	250
HSC12FR	0.50	0.25	0.03	#4-#1	#6-#4	50
HSC12FR250	0.50	0.25	0.03	#4-#1	#6-#4	250
HSC34FR	0.75	0.38	0.03	1/0-3/0	#2-1/0	50
HSC34FR250	0.75	0.38	0.03	1/0-3/0	#2-1/0	250
HSC100FR	1.00	0.50	0.04	4/0-300	1/0-4/0	25
HSC100FR100	1.00	0.50	0.04	4/0-300	1/0-4/0	100
HSC112FR	1.50	0.75	0.04	350-750	250-500	25
HSC112FR100	1.50	0.75	0.04	350-750	250-500	100
HSC200FR	2.00	1.00	0.05	800-1000	500-750	25
HSC200FR100	2.00	1.00	0.05	800-1000	500-750	100

NOTES:

1. Shrink temperature is 135° C (275° F).
2. For best results move heat gun along the length of heat shrink to avoid concentrations.
3. To extend useful life, store material below 70°F.
4. For additional Heat Shrinkable Tubing see "URD" section Type RYAC and RK169-2, RK170-2 in this section.

Shrink Tubing

Thin Wall Heat Shrink Tubing
Flame Retardant, Polyvinyl chloride

TYPE HS-FR

Thin Wall Heat Shrink Tubing,
25, 50, 100, and 250 Foot Reels



UL Recognized to 600V

Type HS-FR is a flexible polyvinyl chloride thin wall heat shrink. Offering insulating, color identification and strain relieving properties for terminations and splices. The 2:1 shrink ratio, allows for faster shrink recovery, covering wire sizes: #16 AWG to 1000 kcmil UL Recognized, 105° C, 600V, the operating temperature from -20° C to 105° C with a shrink temperature of 135° C.

How to Order:

Example: **HSB18FR**

- B** - Black
- BLU** - Blue
- G** - Green
- R** - Red
- W** - White
- Y** - Yellow

Features and Benefits

- UL 224, VW-1 Rated, self-extinguishing flame retardant properties
- Multi-use tubing; insulate, strain relief
- Easy identification available in a wide range of colors
- Low shrink temperature only requires common hot air guns to apply
- Meets MIL-M-23053/Z-206C

Catalog Number	I.D. Expanded	I.D. After Recovery	Wall Thickness	Conductor Range		Standard Reel Size (Feet)
				Code	Flex	
HS_18FR	0.125	0.062	0.025	#16 - #14	#16 - #14	50
HS_18FR250	0.125	0.062	0.025	#16 - #14	#16 - #14	250
HS_14FR	0.250	0.125	0.025	#12 - #8	#12 - #10	50
HS_14FR250	0.250	0.125	0.025	#12 - #8	#12 - #10	250
HS_38FR	0.375	0.187	0.025	#6 - #4	#8 - #6	50
HS_38FR250	0.375	0.187	0.025	#6 - #4	#8 - #6	250
HS_12FR	0.500	0.250	0.025	#4 - #1	#6 - #4	50
HS_12FR250	0.500	0.250	0.025	#4 - #1	#6 - #4	250
HS_34FR	0.750	0.375	0.030	1/0 - 3/0	#2 - 1/0	50
HS_34FR250	0.750	0.375	0.030	1/0 - 3/0	#2 - 1/0	250
HS_100FR	1.000	0.500	0.035	4/0 - 300	1/0 - 4/0	25
HS_100FR100	1.000	0.500	0.035	4/0 - 300	1/0 - 4/0	100
HS_112FR	1.500	0.750	0.040	350 - 750	250 - 500	25
HS_112FR100	1.500	0.750	0.040	350 - 750	250 - 500	100
HS_200FR	2.000	1.000	0.045	800 - 1000	500 - 750	25
HS_200FR100	2.000	1.000	0.045	800 - 1000	500 - 750	100

NOTES:

1. Shrink temperature is 135° C (275° F).
2. For best results move heat gun along the length of heat shrink to avoid concentrations.
3. To extend useful life, store material below 70°F.
4. For additional Heat Shrinkable Tubing see "URD" section Type RYAC and RK169-2, RK170-2 in this section.

TYPE HSIC-FR

Heavy Wall Heat Shrinkable End Cap

UL Listed to 600V



Type HSIC-FR, Heat Shrink Insulating End Cap Fire Retardant is a heavy wall, fire retardant end cap made of cross-linked thermally stabilized black polyolefin. Used to insulate exposed conductors in energized applications. The 3:1 shrink ratio offers greater range, accommodating copper wire sizes, #8 AWG thru 2500+ kcmil. Performs effectively over lead, aluminum, steel, polyethylene, EPR, and PVC jacketed materials. Blue thermal chromatic lines disappear indicating correct installation temperature and provide inspectability. I.D. adhesive provides superior moisture and weather resistant characteristics.



Features and Benefits

- Minimum 28 Oxygen index, UL94 V-O Rated with self-extinguishing flame retardant properties
- 3:1 Shrink Ratio; minimum inventory required
- Thermal chromatic lines indicate proper installation
- Low shrink temperature, 150°C, only requires common hot air gun to apply
- Meets sealing requirements for ANSI-C119.1, UL486D
- Weather and moisture resistant



1. Slide the HSIC-FR end cap onto the cable and hold in place using forefinger or thumb.



2. Beginning at closed end apply heat, blue thermochromatic lines will begin to disappear at 150° C. Gradually, move heat source to open end and around cap. Once lines are no longer visible and adhesive flows out of open end, discontinue heating.



3. HSIC-FR end cap installed on cable.

Catalog Number	600V Cable		Internal Diameter		Wall Thickness		Length ± 20%		# of Pcs. per Pkg.
	Code	Flex	(Min) Exp.	(Max) Rec	Exp.	Rec. ± 20%	Exp.	Rec.	
HSIC81FR	#8-#1	#8-#4	0.50	0.16	0.03	0.08	3.00	2.50	10
HSIC440FR	#4-4/0	#4-2/0	0.75	0.24	0.03	0.08	3.50	2.50	10
HSIC10500FR	1/0-500 kcmil	#1-313.1 kcmil	1.10	0.35	0.04	0.12	4.00	3.00	5
HSIC301000FR	3/0-1000 kcmil	2/0-646 kcmil	1.50	0.47	0.05	0.16	4.50	3.25	5
HSIC200FR	300-1750 kcmil	250-1111 kcmil	2.00	0.63	0.05	0.16	4.50	3.50	5
HSIC350FR	1250 kcmil (min)	—	3.50	1.18	0.05	0.16	5.00	4.50	5

TYPE BHSG1100

Heat Gun

250° - 1100° F (121° - 650° C)

Multi-purpose, low cost heat gun has an electronic variable thermal control dial. BHSG1100 meets the requirements of UL. It has a temperature range of 250° - 1100° F (121° - 650° C). Two (2) speed motor. Built-in safety stand heat guard included. Professional heat gun and accessories are recommended for all of your BURNDY heat shrink applications.



Table of Contents

The HYGROUND® Irreversible Compression System Introduction & Legend	E-2
Compression Connector Grid Example.....	E-3
Ground Rod/Rebar Diameter Chart.....	E-3
Wireless Communications Ground Ring Example.....	E-4
Features & Benefits	E-5
Product Offering Table by Application.....	E-5
HYGRID™ Type YGL-C Ground Grid Cross Connector	E-6
GRIDLOK™ Type YGLR-C Ground Rod to Grid.....	E-7
HYTAP™ Type YGHP-C Figure 6.....	E-8
HYTAP™ Type YGHP-C Ground Rod Tap.....	E-9
HYTAP™ Type YGHC-C Figure C.....	E-10
Type YGHC-CN Concentric Neutral Grounding Connector	E-11
HYTAP™ Type YGHHC-C Double Figure C.....	E-12
COPPER CRIMPIT™ Type YGC.....	E-13
HYTAP™ Type YSHG Double Figure H.....	E-14
HYTAIL™ Type YGHR-C Figure 8 Ground Rod Tap.....	E-15
HYTAIL™ Type YGHR-C Figure 8 Multitap Ground Rod Tap	E-16
HYLUG™ Type YGHA Heavy Duty Terminal.....	E-17
HYLUG™ Type YGA Terminal.....	E-18
GROUNDTAB for Metal Structure Grounding (requires welding)	E-19
HYLINK™ Type YGHS Heavy Duty Splice.....	E-20
HYLINK™ Type YGS Splice	E-21
Type YGF Grounding Plate.....	E-22
GROUNDLINK™ Type YGIB for Structural Steel (angled or parallel beam)	E-23
VERSITAIL™ Type GSTUD-HY Structural Steel Grounding Connector.....	E-25
Types YGT, YTTAG Static Grounding Receptacles	E-26
Type YG-B Connectors for Structural Steel or Bus Bar.....	E-27
HammerTap Ground Rod Clamp	E-28
Type BFB Terminal Lugs Compression Solution for Flexible Bus Bar.....	E-29

Lightning Protection Information

Basic rules for selection are:

1. Must be like material to the conductor.
2. Two bolts to ground rod—minimum, for mechanical.
3. Cable to cable connections can be installed with one bolt, two bolt, or compression means.
4. Cable to steel structure must have 8 in.² contact with steel.
5. Heavy duty stacks—mechanical only.
6. On all connectors with heavy duty stack rating, we must offer 1/16" thick lead plating as an option. The reason is closest 25 ft. to stack opening must use lead coated product.
7. UL 96 Listing.

Most frequently ordered catalog numbers are highlighted in BLUE













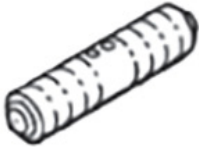

The HYGROUND® Irreversible Compression System

BURNDY® has developed an irreversible compression ground system which meets the most stringent safety and performance requirements, including those of OSHA and nuclear power plant design. Performance excellence and long life expectancy are the system's basic design guidelines. It is a complete system which consists of connectors for grid cross connections, taps, splices, cable to ground rod, ground plates and terminations.

Our irreversible compression ground connectors employ well-proven design principles and technology that have been in existence for over 60 years.

Connectors are just one component of our Irreversible Compression Ground System. Installation tooling is also an integral part of this system. BURNDY® pioneered the compression connector principle and continues today to be the leader in compression technology. Our tooling package is the most extensive in the industry and affords the user many options.

(LEGEND)

				
YGHA	YGA	YGHS	YGS	YG-B
				
YGHP-C	YGHC-C	YGIB	YGL-C	YGLR-C
				
YGF-4N	YGF-2N	YSHG	YGHR-C	GSTUD-HY

The HYGROUND® Irreversible Compression System

Example:

Compression Connector Grid

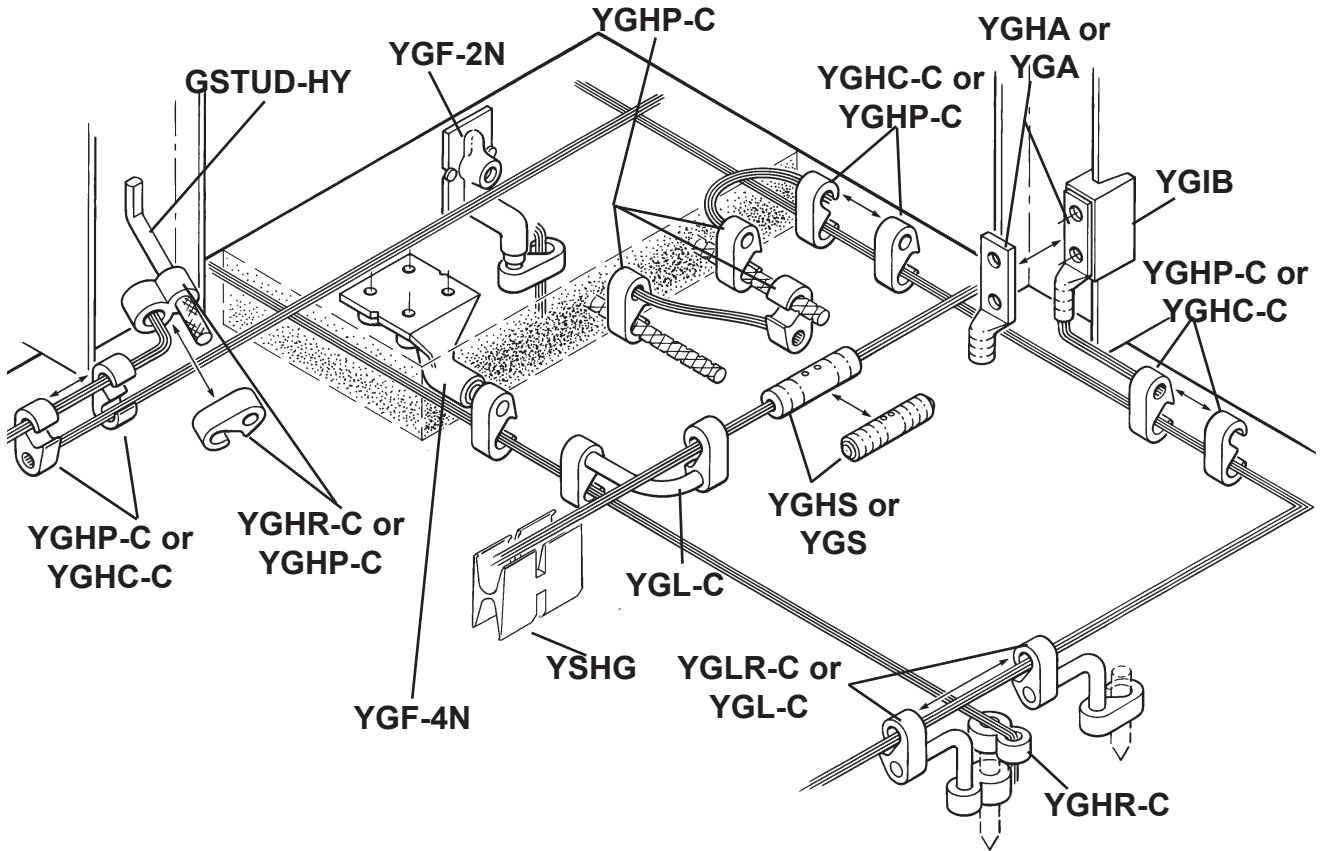

See Legend on Page E-2

Ground Rod and Rebar Diameter Chart				
Size	Ground Rod		Reinforcing Bar (Rebar)	
	Material*	Diameter	Size	Diameter
1/2"	Steel	0.500	#3 (3/8")	0.375
	Copperclad	0.475	#4 (1/2")	0.500
5/8"	Steel	0.625	#5 (5/8")	0.625
	Copperclad	0.563	#6 (3/4")	0.750
3/4"	Steel	0.750	#7 (7/8")	0.875
	Copperclad	0.682	#8 (1")	1.000
1"	Steel	1.000	#9 (1-1/8")	1.128
	Copperclad	0.914	—	—

The HYGROUND® Irreversible Compression System

Example:

Wireless Communications Ground Ring Compression Connector System

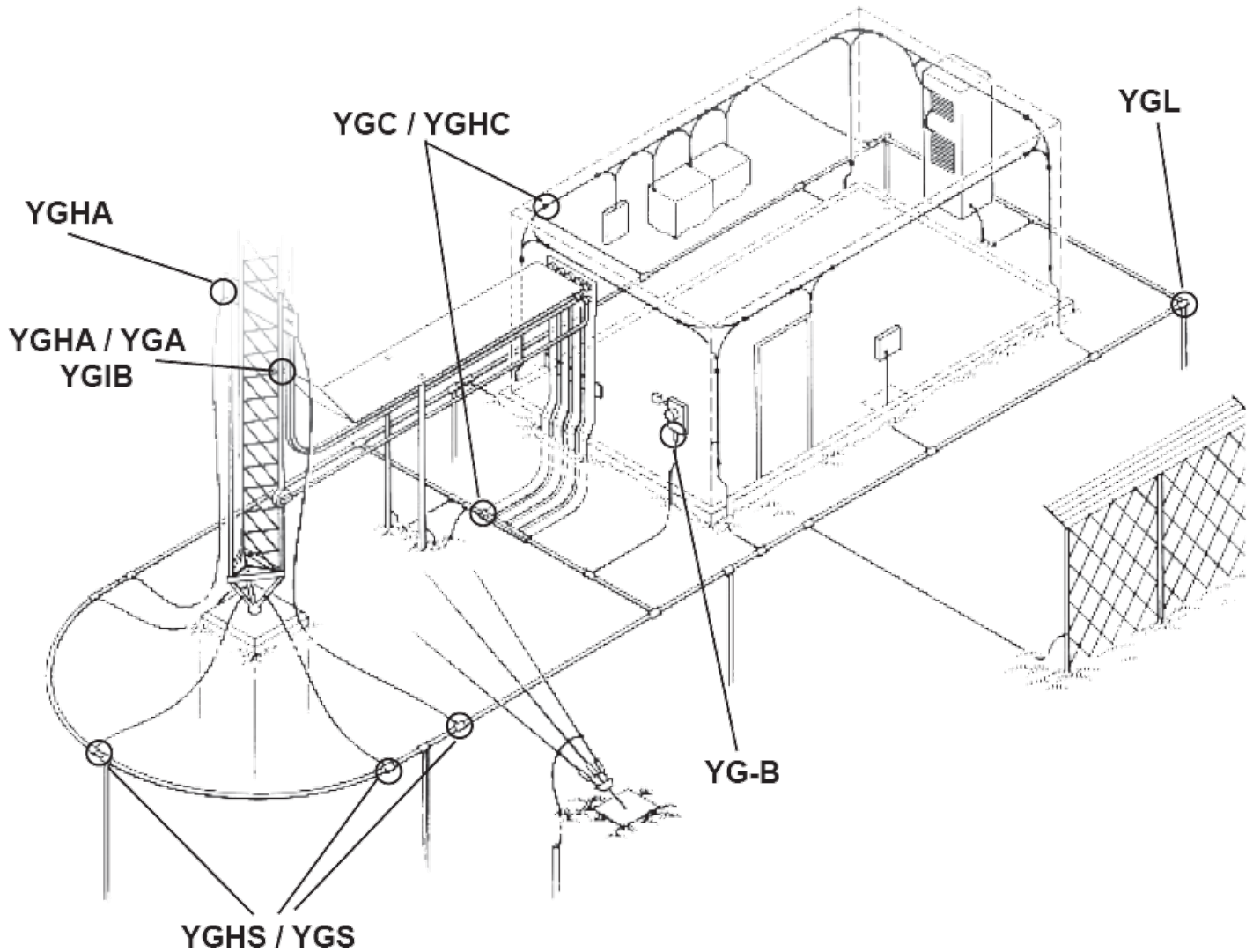

See Legend on Page E-2

The HYGROUND® Irreversible Compression System (Continued)

Features & Benefits

- Irreversible compression system; meets NEC code, section 250
- Pure wrought copper extrusions, rod, and seamless tubing (identical material to the conductor), completely eliminates the possibility of galvanic corrosion due to dissimilar metals
- Heavy duty connector designs; all connectors will carry the equivalent or greater current carrying capacity of the conductor while maintaining high mechanical strength and electrical integrity
- Range take designs for a minimum number of connector combinations required to install a conductor range of #6 solid to 500 kcmil plus 1/2", 5/8", 3/4", and 1" ground rods, and rebar; inventories are kept to a minimum and product selection is simplified
- System engineered tooling; each tooling recommendation ensures reliability of the connection
- Irreversible compression connectors can be installed in all kinds of weather, eliminating costly delays and enables the installer to better schedule the job
- May be installed without special training or special tools, the 750 Series of tools crimps the entire range providing a low installed cost with simplified installation
- Each connection can be made in less than 3 minutes
- Each connector is clearly marked with catalog number, conductor size, and installation die information for easy and accurate identification
- Inspection ports are provided to assure proper insertion of the conductor for built-in quality assurance
- The die index number is embossed on the connector after completion of the crimp facilitating speedy inspection of installed connectors to ensure consistently reliable and sound connections
- Most HYGROUND® irreversible compression elements are prefilled with PENETROX™ oxide inhibitor and individually sealed to keep all contact surfaces in the proper condition for installation as well as ensuring the electrical integrity of the finished connection by inhibiting moisture and contaminants from entering the contact area
- All HYGROUND® irreversible compression connectors are Listed in conformance with Underwriters Laboratories Standard UL467 and conform to applicable sections of the National Electrical Code; HYGROUND® connectors may be used in direct burial or concrete embedded grounding applications
- All HYGROUND® irreversible connectors (with the exception of Types YGA and YGS) have been tested successfully according to requirements of Standard IEEE 837 meeting tough industry performance requirements
- UPRECRIMP dies give added mechanical strength; UPRECRIMP34 is recommended for 3/4" rod; UPRECRIMP12 for 1/2" rod; and UPRECRIMP58 for 5/8" rod (now includes undersized U.S. marketplace rods)
- HYGROUND® connectors allow connection to most sizes of structural steel with no drilling, tapping, or welding — safely installed at low cost and hot work permits are not required to install in hazardous areas

Please contact Customer Service for applications requiring IEEE-837 2014.

HYGROUND® Product Offering Table by Application

Product Family	Connector Type	Wire to Wire	Wire to Ground Rod	Wire to Rebar	Wire to Busbar	Wire Termination	Wire to Structural Steel
YGL	Cross Grid	●	●	●			
YGLR	Ground Rod to Grid		●				
YGHP	Figure 6	●	●	●			
YGHC	Figure C	●	●				
YGHHC	Double C-Tap	●	●				
YGC	CRIMPIT™	●					
YSHG	H-Tap	●		●			
YGHR	Figure 8		●				
YGA	Lug (standard duty)				●	●	
YGHA	Lug (heavy duty)				●	●	
YGS	Splice (standard duty)	●					
YGHS	Splice (heavy duty)	●					
YGIB	I-Beam Connector						●
YG-B	Busbar Connector				●		

HYGRID™ Type YGL-C Cross Connector

An irreversible compression ground grid cross connector which allows adjustment of the compression elements prior to installation. Only six connectors and four dies are required to install all combinations from #6 solid through 500 kcmil. UL467 Listed. Acceptable for direct burial in earth and concrete. Prefilled with PENETROX™ compound and strip sealed.



467 96



IEEE-837*

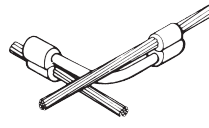
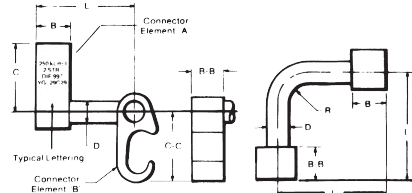

Ground Grid Cross Connection

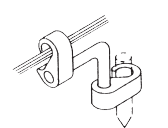

Cable to Ground Rod

Catalog Number	B	BB	C	C-C	D	L	R
YGL2C2	0.75	0.75	1.09	1.09	0.31	2.50	0.31
YGL29C2			1.66	1.09	0.31		0.31
YGL29C29			1.66	1.66	0.50		0.50
YGL34C2			2.09	1.09	0.31		0.31
YGL34C29			2.09	1.66	0.50		0.50
YGL34C34			1.10	1.10	2.28		2.28

UL96 Listed for Lightning Protection.

Catalog Number	Cable to Cable		Cable to Ground Rod ③		To Rebar
	Element "A"	Element "B"	Element "A"	Element "B"	Element "A"
YGL2C2	#6 Sol. (0.162) - #2 Str. (0.292) {59500} - {59500}	#6 Sol. (0.162) - #2 Str. (0.292) {59500} - {59500}	—	—	—
YGL29C2	#1 Str. (0.332) - 250 kcmil (0.575) {98500} - {131500}	#6 Sol. (0.162) - #2 Str. (0.292) {59500} - {59500}	1/2" - 5/8" Rod	#6 Sol. (0.162) - #2 Str. (0.292)	3/8" - 1/2"
YGL29C29	#2 Str. (0.292) - 250 kcmil (0.575) {65500} - {131500}	#2 Str. (0.292) - 250 kcmil (0.575) {65500} - {131500}	1/2" - 5/8" Rod	#2 Str. (0.292) - 250 kcmil (0.575)	#3 - 4 Rebar
YGL34C2	250 kcmil (0.575) - 500 kcmil (0.813)	#6 Sol. (0.162) - #2 Str. (0.292)	5/8" - 3/4" Rod	#6 Sol. (0.162) - #2 Str. (0.292)	5/8" - 3/4" #5 - 6 Rebar
YGL34C29		#2 Str. (0.292) - 250 kcmil (0.575)		#2 Str. (0.292) - 250 kcmil (0.575)	
YGL34C34		250 kcmil (0.575) - 500 kcmil (0.813)		250 kcmil (0.575) - 500 kcmil (0.813)	

Dimensions in brackets { } represent lightning protection conductors.

Catalog Number	Installation Tools, Die Set Catalog Number (Number of Crimps)					
	750, 35 Series		45 Series ①		46 Series ②	
	Element "A"	Element "B"	Element "A"	Element "B"	Element "A"	Element "B"
YGL2C2	UO (1)	UO (1)	UO (1)	UO (1)	UO (1)	UO (1)
YGL29C2	U997 (1)	UO (1)	U997 (1)	UO (1)	U997 (1)	UO (1)
YGL29C29	U997 (1)	U997 (1)	U997 (1)	U997 (1)	U997 (1)	U997 (1)
YGL34C2 †	PU998 (1)	UO (1)	S998 or PU998 (1)	UO (1)	P998 or PU998 (1)	UO (1)
YGL34C29 †	PU998 (1)	U997 (1)	S998 or PU998 (1)	U997 (1)	P998 or PU998 (1)	U997 (1)
YGL34C34 †	U1011 (3)	U1011 (3)	S1011 (3)	S1011 (3)	P1011 (3)	P1011 (3)

① 45 Series tools require PT6515 adapter to use "U" or "PU" die

② 46 Series tools require PUADP1 adapter to use "U" or "PU" die

† These connectors can only be installed using the 750, 45, or 46 Series tools with the recommended dies.

*Please contact Customer Service for applications requiring IEEE-837 2014.

NOTES:

- Before crimping, both connector elements can be turned on rod diameter "D" to any desired position.
- Clean rust and/or protective coatings from rebar prior to installation.

③ When attaching connector to ground rod, ground rod must be embossed with appropriate PRECRIMP die. For connectors that must meet IEEE 837 requirements, UPRECRIMP-type precrimp dies must be used for maximum clamping retention. No precrimp needed if using S1012, P1011 or U1011 die sets.

Ground Rod ③ Dia.	PRECRIMP Dies	
1/2"	UPRECRIMP12	U2CABT
5/8"	UPRECRIMP58	
3/4"	UPRECRIMP34	

GRIDLOK™ Type YGLR-C Ground Rod to Grid Connector

Ground grid connector for a wide range of copper cable to ground rod. Provides high torque strength on ground rod. UL467 Listed. Acceptable for direct burial in earth and concrete. Prefilled with PENETROX™ compound and strip sealed.

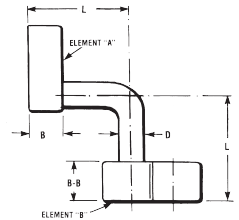

IEEE-837*



Catalog Number	B	B-B	D	L	Commercial Copper Cable Range Element "A"	Metric Copper Cable Range Element "A"	CopperWeld Cable Range Element "A"	Ground Rod Dia Element "B"
YGLR29C12	0.75	0.88 [22.4]	0.31	2.53	#2 Str. (0.292 Dia.) - 250 kcmil (0.575 Dia.)	35mm ² (7.62mm Dia.) - 120 mm ² (14.40mm Dia.)	91.65 kcmil (0.343 Dia.) - 248.8 kcmil (0.572 Dia.)	1/2" [12.7]
YGLR34C12	0.75	0.88 [22.4]	0.31	2.53	250 kcmil (0.575 Dia.) - 500 kcmil (0.813 Dia.)	120 mm ² (14.40mm Dia.) - 240 mm ² (20.35mm Dia.)	248.8 kcmil (0.572 Dia.) - 498.8 kcmil (0.810 Dia.)	5/8" [15.9]
YGLR29C58	0.75	0.88 [22.4]	0.31	2.53	#2 Str. (0.292 Dia.) - 250 kcmil (0.575 Dia.)	35mm ² (7.62mm Dia.) - 120 mm ² (14.40mm Dia.)	91.65 kcmil (0.343 Dia.) - 248.8 kcmil (0.572 Dia.)	3/4" [19.1]
YGLR34C58	0.75	0.88 [22.4]	0.31	2.53	250 kcmil (0.575 Dia.) - 500 kcmil (0.813 Dia.)	120 mm ² (14.40mm Dia.) - 240 mm ² (20.35mm Dia.)	248.8 kcmil (0.572 Dia.) - 498.8 kcmil (0.810 Dia.)	1" [25.4]
YGLR29C34	0.75	0.88 [22.4]	0.50	2.63	#2 Str. (0.292 Dia.) - 250 kcmil (0.575 Dia.)	35mm ² (7.62mm Dia.) - 120 mm ² (14.40mm Dia.)	91.65 kcmil (0.343 Dia.) - 248.8 kcmil (0.572 Dia.)	
YGLR34C34	0.75	0.88 [22.4]	0.50	2.63	250 kcmil (0.575 Dia.) - 500 kcmil (0.813 Dia.)	120 mm ² (14.40mm Dia.) - 240 mm ² (20.35mm Dia.)	248.8 kcmil (0.572 Dia.) - 498.8 kcmil (0.810 Dia.)	
YGLR29C100	0.75	0.88 [22.4]	0.50	2.63	#2 Str. (0.292 Dia.) - 250 kcmil (0.575 Dia.)	35mm ² (7.62mm Dia.) - 120 mm ² (14.40mm Dia.)	91.65 kcmil (0.343 Dia.) - 248.8 kcmil (0.572 Dia.)	
YGLR34C100	0.75	0.88 [22.4]	0.50	2.63	250 kcmil (0.575 Dia.) - 500 kcmil (0.813 Dia.)	120 mm ² (14.40mm Dia.) - 240 mm ² (20.35mm Dia.)	248.8 kcmil (0.572 Dia.) - 498.8 kcmil (0.810 Dia.)	

Catalog Number	Installation Tools, Die Set Cat. No. (Number of Crimps)							
	35 Series		750 Series		45 Series ①		46 Series ②	
	Element "A"	Element "B"	Element "A"	Element "B"	Element "A"	Element "B"	Element "A"	Element "B"
YGLR29C12	U997 (1)	PU998 (1)	U997 (1)	U1011 (2) or PU998 (1)	U997 (1)	S1012 (2) or PU998 (1)	U997 (1)	P1011 (2) or PU998 (1)
YGLR34C12	—	—	U1011 or PU998 (1)	U1011 (2) or PU998 (1)	S998 or PU998 (1)	S1012 (2) or PU998 (1)	P998 or PU998 (1)	P1011 (2) or PU998 (1)
YGLR29C58	U997 (1)	PU998 (1)	U997 (1)	U1011 (2) or PU998 (1)	U997 (1)	S1012 (2) or PU998 (1)	U997 (1)	P1011 (2) or PU998 (1)
YGLR34C58	—	—	U1011 or PU998 (1)	U1011 (2) or PU998 (1)	S998 or PU998 (1)	S1012 (2) or PU998 (1)	P998 or PU998 (1)	P1011 (2) or PU998 (1)
YGLR29C34	U997 (1)	PU998 (1)	U997 (1)	U1011 (2) or PU998 (1)	U997 (1)	S1012 (2) or PU998 (1)	U997 (1)	P1011 (2) or PU998 (1)
YGLR34C34	—	—	U1011 (2) or PU998 (1)	U1011 (2) or PU998 (1)	U1011 (2) or PU998 (1)	S1012 (2) or PU998 (1)	U1011 (2) or PU998 (1)	P1011 (2) or PU998 (1)
YGLR29C100	—	—	U997 (1)	U1011 (2) or PU998 (1)	U997 (1)	S1012 (2) or PU998 (1)	U997 (1)	P1011 (2) or PU998 (1)
YGLR34C100	—	—	U1011 (2) or PU998 (1)	U1011 (2) or PU998 (1)	U1011 (2) or PU998 (1)	S1012 (2) or PU998 (1)	U1011 (2) or PU998 (1)	P1011 (2) or PU998 (1)

NOTES:

- ① Where a "U" or "PU" die is recommended with 45 Series tool, a PT6515 adapter must be used.
- ② Where a "U" or "PU" die is recommended with the 46 Series tool, a PUADP1 adapter must be used.

- Before crimping, both connector elements can be turned on rod diameter "D" to any desired position.
- ③ When attaching connector to ground rod, ground rod must be embossed with appropriate PRECRIMP die. For connectors that must meet IEEE 837 requirements, UPRECRIMP-type precrimp dies must be used for maximum clamping retention. No precrimp needed if using S1012, P1011 or U1011 die sets.

*Please contact Customer Service for applications requiring IEEE-837 2014.

Ground Rod Dia. ③	PRECRIMP Dies	
1/2"	UPRECRIMP12	
5/8"	UPRECRIMP58	U2CABT
3/4"	UPRECRIMP34	

HYTAP™ Type YGHP-C Figure 6 Connector

Irreversible compression ground tap figure 6 can be used as a tap connector or as a tap splice connector. Four die sets and eight connectors can accommodate a conductor range from #8 solid through 500 kcmil plus 1/2", 5/8" and 3/4" copper bonded ground rods. UL467 Listed. Acceptable for direct burial in earth and concrete. Prefilled with PENETROX™ compound and strip sealed.



IEEE-837*

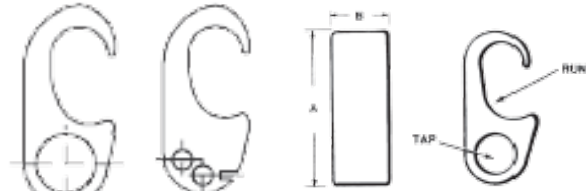

Fig. 1

Fig. 2

✓ UL96 Listed for Lightning Protection.

Dimensions in brackets { } represent lightning protection conductors.

Catalog Number	Fig. #	Accommodates		⑦ Cable to Rebar		B	Die Index	Installation Data			
		Run ⑧	Tap	Run	Tap			750, 35 Series	45 Series ①	46 Series ②	# of Crimps
YGHP2C2	1	#6 Sol. (0.162) {59500} - #2 Str. (0.292) {59500}	④ #6 Sol. (0.162) {59500} - #2 Str. (0.292) {59500}	—	—	0.75	O	UO	UO	UO	1
YGHP2C6W6W ⑤	2	#6 Sol. (0.162) - #2 Str. (0.292)	#8 Sol. (0.128) - #6 Str. (0.184) Qty. 2	—	—						1
YGHP29C6W6W ⑤	2		#8 Sol. (0.128) - #6 Str. (0.184) Qty. 2	#3 Rebar 3/8 - 1/2 #4 Rebar	#8 Sol. - 6 Str.						1
YGHP29C2	1	1/0 Str. (0.372) {98500} - 250 kcmil (0.575) {131500}	#4 Sol. (0.204) {#4 Sol.} - #2 Str. (0.292) {#2 Str.}	#3 Rebar 3/8 - 1/2 #4 Rebar	#4 Sol. - 2 Str.	2.31	997	U997	U997	U997	1
YGHP29C26	1	1/2" - 5/8" Rod	1/0 Str. (0.372) {98500} - 2/0 Str. (0.419) {98500}	#3 Rebar 3/8 - 1/2 #4 Rebar	1/0 Str. - 2/0 Str.						1
YGHP29C29 ⑥	1		3/0 Str. (0.470) {131500} - 250 kcmil (0.575) {211500}	#3 Rebar 3/8 - 1/2 #4 Rebar	3/0 Str. - 250 kcmil						1
YGHP34C2 ③	1	250 kcmil (0.575) {250 kcmil} - 500 kcmil (0.813) {500 kcmil} 5/8" - 3/4" Rod	#4 Sol. (0.204) - #2 Str. (0.292)	#5 Rebar 5/8 - 3/4 #6 Rebar	—	998	PU998	PU998 or S998	PU998 or P998	1	
YGHP34C26 ③	1		1/0 Str. (0.372) {98500} - 2/0 Str. (0.419) {98500}	#5 Rebar 5/8 - 3/4 #6 Rebar	1/0 Str. - 2/0 Str.					1	
YGHP34C29 ③	1		3/0 Str. (0.470) {131500} - 250 kcmil (0.575) {211500}	#5 Rebar 5/8 - 3/4 #6 Rebar	3/0 Str. - 250 kcmil					1	
YGHP34C34 ③	1	250 kcmil (0.575) - 500 kcmil (0.813) 5/8" - 3/4" Rod	350 kcmil (0.681) - 500 kcmil (0.843)	#5 Rebar 5/8 - 3/4 #6 Rebar	350 kcmil - 500 kcmil	2.75	1011	U1011	S1011	P1011	3

NOTES:

- ① 45 Series tools require PT6515 adapter to use "U" or "PU" die
- ② 46 Series tools require PUADP1 adapter to use "U" or "PU" die
- ③ These connectors can only be installed using the 750, 45 or 46 Series tools; cannot be installed with the 35 Series.
- ④ When using #6 Sol in tap, fold conductor double for improved fill.
- ⑤ Not UL96/CSA
- ⑥ When using 3/0 in tap, minimum run conductor must be 2/0 Str.
- ⑦ Clean rust and protective coatings from rebar prior to installation to provide proper ground connection. Precrimping is not required.

*Please contact Customer Service for applications requiring IEEE-837 2014.

Ground Rod ⑧ Dia.	PRECRIMP Dies	
1/2"	UPRECRIMP12	U2CABT
5/8"	UPRECRIMP58	
3/4"	UPRECRIMP34	

③ When attaching connector to ground rod, ground rod must be embossed with appropriate PRECRIMP die. For connectors that must meet IEEE 837 requirements, UPRECRIMP-type precrimp dies must be used for maximum clamping retention. No precrimp needed if using S1012, P1011 or U1011 die sets.

HYTAP™ Type YGHP-C Ground Rod Tap Connector

Type YGHP-C irreversible compression ground tap figure 6 can be used as a ground rod tap connector for both continuous run and tapping applications. An open groove allows ground rod to be connected to a continuous run or tap. The second groove is for a tap only. Prefilled with PENETROX™ E and strip sealed. UL467 Listed for direct burial in earth or concrete. *For applications requiring IEEE-837 2014, please contact Customer Service.

IEEE-837*



Features & Benefits

- Tap A accepts a continuous run or tap conductor; Tap B accepts a tap conductor only; one connector style can be used for many applications reducing the number of connectors required in inventory
- Material is high conductivity wrought copper extrusion, identical material to the conductor, minimizing resistance and voltage drop; additionally eliminates the possibility of corrosion due to dissimilar metals
- System engineered tooling has been designed to ensure a reliable, dependable connection every time
- Die index number is embossed on connector after completion of crimp facilitating inspection of installed connectors and ensures consistently reliable and dependable connections
- Prefilled with PENETROX™ E compound and individually sealed in clear polyethylene sheet ensuring electrical integrity of the finished connection by inhibiting moisture and contaminants from entering the contact area
- UL467 Listed and may be used in direct burial or concrete embedded grounding applications providing quality assurance to recognized industry NEC standard from an independent party
- "Third Hand" constrains conductors while installer completes crimp is included with each connector simplifying installation and reducing installed cost

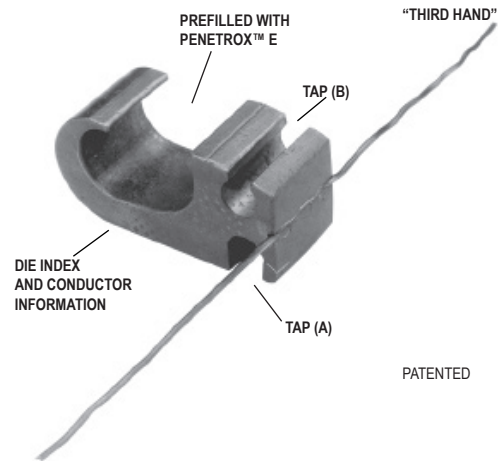

PATENTED

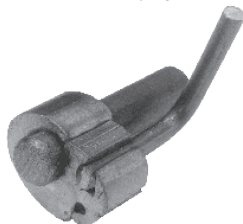
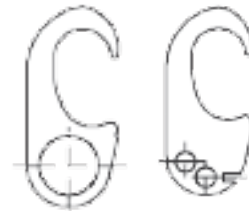
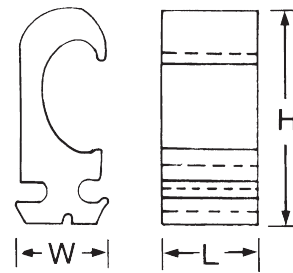

SINGLE TAP

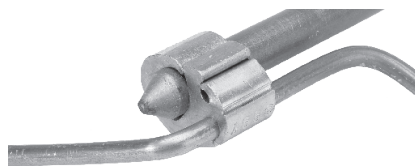

CONTINUOUS RUN

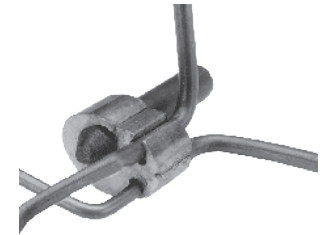

CONTINUOUS RUN AND TAP

Catalog Number	Ground Rod Dia. ①	Tap Conductor ②	Dimensions			Installation Tooling Die Number ③ (# of Crimps)		Die Index
			H	L	W	35, 750 Series	④ 46 Series	
YGHP58C2W-2	1/2" - 5/8"	#2 Sol. - #6 Sol. Copper (1) Continuous Run and (1) Tap or up to (2) Taps may be connected	1.90"	0.75"	0.94"	U997 (1)	U997 (1)	997
YGHP58C2W-2TN								

① Ground rod must be precrimped with die U2CABT (Index 348); for greater rotational resistance use UPRECRIMP die; Galvanized Steel Rods require YGHP58C2W-2TN

② Either tap position may be left void when fewer than (2) conductors are used

③ See Tooling Section in Master Catalog for complete tool and die listing

④ Use PUADP1 adapter when using "U"-dies in 46 Series tools

NOTE:

A 12" bend radius is recommended for the conductor

HYTAP™ Type YGHC-C Figure C Connector

Irreversible compression ground tap figure "C" connectors. Accommodates all cable combinations from #6 solid through 500 kcmil. "C"- shaped opening permits placing two continuous parallel cables into conductor groove. UL 467 Listed. Acceptable for direct burial in earth or concrete. Prefilled with PENETROX™ compound and strip sealed. Certain sizes are also UL467 Listed and CSA Certified for wire to ground rod.

IEEE-837*

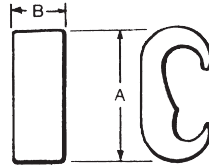

UL96 Listed for Lightning Protection.

Dimensions in brackets { } represent lightning protection conductors.

Catalog Number	Commercial Copper Cable to Cable or Cable to Ground Rod		Stranded Copper Cable Range Metric		A	B	Die Index No.	Installation Data			No. of Crimps
	Run	Tap	Run	Tap				750, 35 Series	45 Series	46 Series	
YGHC2C2	#6 Sol. (0.162) #2 Str. (0.292) 1/4" Rod	#6 Sol. (0.162) #2 Str. (0.292)	10 mm ² (4.12 mm) 35 mm ² (7.62 mm)	10 mm ² (4.12 mm) 35 mm ² (7.62 mm)	1.16	0.75	C	U-C	U-C	U-C	1
YGHC26C2	1 Str. (0.328) {98500} 2/0 Str. (0.419) {98500} 3/8" Rod	#6 Sol. (0.162) {#6 Sol.} #2 Str. (0.292) {#2 Str.}	35 mm ² (7.62 mm) 70 mm ² (10.9 mm)	10 mm ² (4.12 mm) 35 mm ² (7.62 mm)	1.41	0.75	O	U-O	U-O	U-O	1
YGHC26C26	1 Str. (0.328) {98500} 2/0 Str. (0.419) {98500} 3/8" Rod	1 Str. (0.328) {98500} 2/0 Str. (0.419) {98500}	35 mm ² (7.62 mm) 70 mm ² (10.9 mm)	35 mm ² (7.62 mm) 70 mm ² (10.9 mm)	1.54	0.75	O	U-O	U-O	U-O	1
YGHC29C26	3/0 Str. (0.470) {3/0 Str.} 250 kcmil (0.575) {250 kcmil} 1/2" or 5/8" Rod	6 Sol. (0.162) {59500} 2/0 Str. (0.419) {98500}	95 mm ² (12.5 mm) 120 mm ² (14.4 mm)	10 mm ² (4.10 mm) 70 mm ² (10.90 mm)	1.97	0.75	997	U997	U997	U997	1
YGHC29C29	3/0 Str. (0.470) 250 kcmil (0.575) 1/2" or 5/8" Rod	3/0 Str. (0.470) 250 kcmil (0.575)	95 mm ² (12.5 mm) 120 mm ² (14.4 mm)	95 mm ² (12.5 mm) 120 mm ² (14.4 mm)	2.06	0.88	997	U997	U997	U997	1
YGHC34C26	300 kcmil (0.630) {300 kcmil} 500 kcmil (0.813) {500 kcmil} 3/4" Rod	6 Sol. (0.162) {59500} 2/0 Str. (0.419) {98500}	150 mm ² (16 mm) 240 mm ² (20.35 mm)	10 mm ² (4.10 mm) 70 mm ² (10.90 mm)	2.42	0.88	1011	U1011	S1011	P1011	2
YGHC34C29	300 kcmil (0.630) 500 kcmil (0.813)	3/0 Str. (0.470) 250 kcmil (0.575)	150 mm ² (16 mm) 240 mm ² (20.35 mm)	95 mm ² (12.5 mm) 120 mm ² (14.4 mm)	2.67	0.88	1011	U1011	S1011	P1011	2
YGHC34C34	300 kcmil (0.630) 500 kcmil (0.813)	300 kcmil (0.630) 500 kcmil (0.813)	150 mm ² (16 mm) 240 mm ² (20.35 mm)	150 mm ² (16 mm) 240 mm ² (20.35 mm)	2.91	1.10	1011	U1011	S1011	P1011	3

- ① 45 Series tools require PT6515 adapter to use "U" or "PU" die
- ② 46 Series tools require PUADP1 adapter to use "U" or "PU" die
- ③ When attaching connector to ground rod, ground rod must be embossed with appropriate PRECRIMP die. For connectors that must meet IEEE 837 requirements, UPRECRIMP-type precrimp dies must be used for maximum clamping retention. No precrimp needed if using S1012, P1011 or U1011 die sets.
- ④ Ground rod to copper cable is UL467 Listed for direct burial in earth and concrete
- ⑤ These connectors cannot be installed with the 35 Series

NOTES:
Listed under UL486A for copper wire connectors
For connectors without PENETROX™ oxide inhibitor, add suffix "NP" to the end of the catalog number (example: YGHC2C2-NP)

*Please contact Customer Service for applications requiring IEEE-837 2014.

Ground Rod ③ Dia.	PRECRIMP Dies	
1/2"	UPRECRIMP12	U2CABT
5/8"	UPRECRIMP58	
3/4"	UPRECRIMP34	

Type YGHC-CN Concentric Neutral Grounding Connector

Type YGHC-CN irreversible compression grounding figure "C" connectors are used to ground concentric neutral used in medium voltage cable. Primarily used in wind and solar farm applications, the YGHC-CN connectors accommodate common sizes of flat strap and round concentric neutral strands. For inspection purposes, these connectors are clearly marked with the wire range, catalog number, and die set necessary for proper installation.



Features & Benefits

- Type YGHC-CN connectors provide a grounding solution for medium voltage concentric neutral commonly used at wind and solar farms
- Irreversible and maintenance free connection
- Connectors are clearly marked with wire size range, catalog number and necessary die set for proper installation
- Die embossment will appear on connector after proper installation for inspection purposes
- Accommodates both flat and round concentric neutral strands
- Type YGHC-CN connectors can be installed using the standard tools and dies similar to the traditional YGHC type connectors
- Add suffix -NP for connector without PENETROX™ oxide inhibitor

For Round Concentric Neutral

Catalog Number	Conductor		Installation Data		
	Cable #1	Cable #2	750 Series	46 Series ①	No. of Crimps
YGHC2C2CN	#6 - #2 AWG Str	9X-25x 16AWG Sol	UC	UC	1
	#6 - #2 AWG Str	6X-16x 14AWG Sol			
	#6 - #2 AWG Str	6X-10x 12AWG Sol			
YGHC26C26CN	#1 - 2/0 AWG Str	26X-32x 16AWG Sol	UO	UO	1
	#1 - 2/0 AWG Str	17X-32x 14 AWG Sol			
	#1 - 2/0 AWG Str	11X-20x 12 AWG Sol			
YGHC29C29CN	3/0 AWG - 250 kcmil Str	21X-32x 12AWG Sol	U997	U997	1

For Flat Strap Concentric Neutral

Catalog Number	Conductor			Installation Data		
	Cable #1	Cable #2		750 Series	46 Series ①	No. of Crimps
		Quantity	Size (in)			
YGHC2C2CN	#6 - #2 AWG Str	4	0.162x0.025	UC	UC	1
	#2 AWG Str	12	0.162x0.025			
	#6 - #2 AWG Str	4	0.193x0.025			
YGHC26C26CN	#1 - 2/0 AWG Str	13	0.162x0.025	UO	UO	1
	2/0 AWG Str	25	0.162x0.025			
	#1 - 2/0 AWG Str	11	0.193x0.025			
	2/0 AWG Str	21	0.193x0.025			
YGHC29C29CN	3/0 AWG - 250 kcmil Str	22	0.193x0.025	U997	U997	1
	250 kcmil Str	25	0.193x0.025			

① 46 Series tools require PUADP1 adapter to use "U" or "PU" die
 Add suffix -NP (example: YGHC26C26CNP) for connector without PENETROX™ oxide inhibitor

HYTAP™ Type YGHHC-C Double Figure C Connector

Irreversible compression ground tap figure "C" connectors. Accommodates all cable combinations from #6 solid through 500 kcmil. "C"-shaped opening permits placing two continuous parallel cables into conductor groove. The YGHHC-C series is qualified to IEEE-837 2014. Prefilled with PENETROX™ compound and strip sealed.

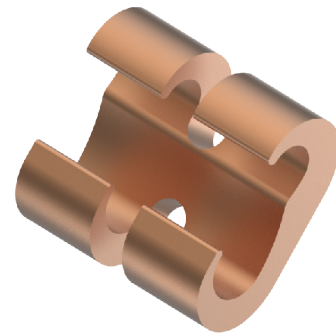

IEEE-837*

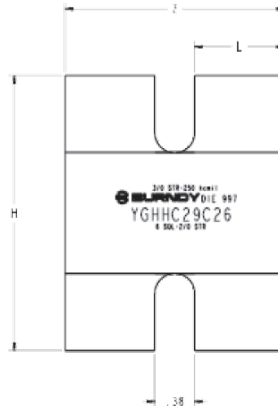

Catalog Number	Commercial Copper Cable to Cable or Cable to Ground Rod ③		Stranded Copper Cable Range Metric		H	L	Z	Die Index No.	Installation Data			No. of Crimps
	Run	Tap	Run	Tap					750, 35 Series	45 ① Series	46 ② Series	
YGHHC26C26	1 Str. (0.328) 2/0 Str. (0.419) 3/8" Rod	1 Str. (0.328) 2/0 Str. (0.419)	35 mm² (7.62 mm) 70 mm² (10.9 mm)	35 mm² (7.62 mm) 70 mm² (10.9 mm)	1.54 [39]	0.75 [19]	1.88 [48]	0	U0	U0	U0	2
YGHHC29C26	3/0 Str. (0.470) 250 kcmil (0.575) 1/2" or 5/8" Rod	6 Sol. (0.162) 2/0 Str. (0.419)	95 mm² (12.5 mm) 120 mm² (14.4 mm)	10 mm² (4.10 mm) 70 mm² (10.90 mm)	1.97 [50]	0.88 [22]	2.13 [54]	997	U997	U997	U997	2
YGHHC29C29	3/0 Str. (0.470) 250 kcmil (0.575) 1/2" or 5/8" Rod	3/0 Str. (0.470) 250 kcmil (0.575)	95 mm² (12.5 mm) 120 mm² (14.4 mm)	95 mm² (12.5 mm) 120 mm² (14.4 mm)	2.06 [52]	0.88 [22]	2.13 [54]	997	U997	U997	U997	2
YGHHC34C26 ⑤	300 kcmil (0.630) 500 kcmil (0.813) 3/4" Rod	6 Sol. (0.162) 2/0 Str. (0.419)	150 mm² (16 mm) 240 mm² (20.35 mm)	10 mm² (4.10 mm) 70 mm² (10.90 mm)	2.42 [62]	0.88 [22]	2.13 [54]	1011	U1011	S1011	P1011	4
YGHHC34C29 ⑤	300 kcmil (0.630) 500 kcmil (0.813)	3/0 Str. (0.470) 250 kcmil (0.575)	150 mm² (16 mm) 240 mm² (20.35 mm)	95 mm² (12.5 mm) 120 mm² (14.4 mm)	2.67 [68]	0.88 [22]	2.13 [54]	1011	U1011	S1011	P1011	4
YGHHC34C34 ⑤	300 kcmil (0.630) 500 kcmil (0.813)	300 kcmil (0.630) 500 kcmil (0.813)	150 mm² (16 mm) 240 mm² (20.35 mm)	150 mm² (16 mm) 240 mm² (20.35 mm)	2.91 [74]	1.10 [28]	2.58 [66]	1011	U1011	S1011	P1011	6

① 45 Series tools require PT6515 adapter to use "U" or "PU" die
 ② 46 Series tools require PUADP1 adapter to use "U" or "PU" die
 ③ When attaching connector to ground rod, ground rod must be embossed with appropriate PRECRIMP die. For connectors that must meet IEEE 837 requirements, UPRECRIMP-type precrimp dies must be used for maximum clamping retention. No precrimp needed if using S1012, P1011 or U1011 die sets.
 ⑤ These connectors cannot be installed with the 35 Series

Ground Rod Dia. ③	PRECRIMP Dies	
1/2"	UPRECRIMP12	U2CABT
5/8"	UPRECRIMP58	
3/4"	UPRECRIMP34	

COPPER CRIMPIT™ Type YGC

UL 467 Listed for direct burial in earth or concrete. Prefilled with PENETROX™ E2 oxide inhibitor.



Catalog Number	Copper Conductor (Sol. & Str.)		H	L	Die Index	OUR840	MD6/MD7	Number of Crimps
	Run	Tap						
YGC10C10	10 AWG	10 AWG	0.37	0.32	238	W238	W238	1
YGC8C8	8 AWG	8 AWG	0.46	0.52	162	W162	W162	2
YGC6C8	6 AWG	8 AWG	0.73	0.62	BG	XBG	WBG	2
YGC6C6	6 AWG	6 AWG	0.76	0.62	BG	XBG	WBG	2
YGC4C4	4 AWG	4 AWG	0.81	0.62	BG	XBG	WBG	2

HYTAP™ Type YSHG Double Figure H Connector

Type YSHG Double H-Tap grounding series is comprised of five connectors designed to accommodate wire range sizes #14 through 500 kcmil, including ground rod sizes: 3/4", 1", and rebar sizes: #6, #7, #8 and #9. Prefilled with PENETROX™ E2 and strip sealed.

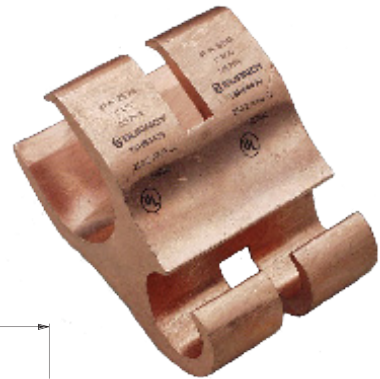

Features & Benefits

- UL467 Listed, suitable for direct burial in earth or concrete
- Material is high conductivity copper extrusion to minimize resistance and eliminate corrosion due to dissimilar metals
- Grooves are prefilled with PENETROX™ E2 oxide inhibitor and individually sealed to inhibit moisture and contaminants ensuring electrical integrity

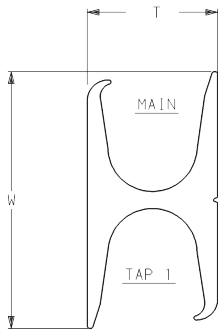
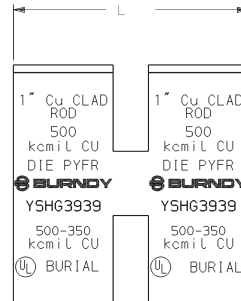

Fig. 1

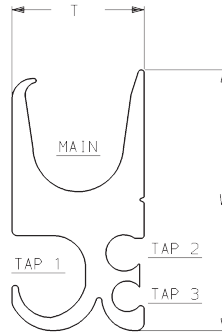

Fig. 2

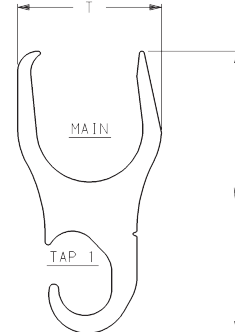

Fig. 3

Catalog Number	Fig. #	Conductor Sizes				Tooling (# of crimps)		Index Embossment	W ±.06	T ±.04	L ±.06
		Main	Tap 1	Tap 2	Tap 3	750 Series	46 Series				
YSHG4429	3	#9 & #8 Rebar, 1" [25] Ground Rod	250 - 2	—	—	—	PYFR (2)	KR	3.22	1.70	2.44
YSHG3931 ①	2	#6 & #7 Rebar, 1" [25] Cu Clad Ground Rod, 3/4" Ground Rod 500 - 350 kcmil Copper	4/0 - 1/0	1 - 6	2 - 14	—	PYFR (2)	KR	2.97	1.50	2.34
YSHG3434	1	#6 Rebar, 3/4" [19] Ground Rod 400 - 250 kcmil Copper	400 - 4/0	—	—	U1104 (4)	P1104 (2) ② U1104 (4)	1104	2.43	1.15	2.44
YSHG3429	2	#6 Rebar, 3/4" [19] Ground Rod 400 - 4/0 kcmil Copper	3/0 - 1/0	1 - 4	8 - 14	U1104 (4)	P1104 (2) ② U1104 (4)	1104	2.23	1.31	2.44

① Not for use on 1" steel ground rod

② Use PUADP1 adapter

HYTAIL™ Type YGHR-C Ground Rod Tap Connector

High torque strength ground rod connectors. Accommodates a wide range of copper conductors to ground rod. UL467 Listed. Acceptable for direct burial in earth or concrete. Prefilled with PENETROX™ compound and strip sealed.



IEEE-837*

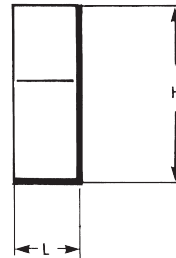

Catalog Number	H	L	Commercial Copper Cable Range	Nominal Ground Rod ③ Dia.	Installation Tools, Die Set Catalog Number (# of Crimps)		
					750, 35 Series	45 Series ①	46 Series ②
YGHR26C12	1.94	0.88	#2 Str. (0.29 Dia.) - 2/0 Str. (0.42 Dia.)	1/2" [12.70]	U1011 (2) PU998 (1)	S1012 (2) PU998 (1)	P1011 (2) PU998 (1)
YGHR26C58	1.97			5/8" [15.90]			
YGHR26C34	2.19			3/4" [19.00]			
YGHR26C100 ⑤	2.55			1" [25.40]			
YGHR29C12	1.94		#4/0 Str. (0.53 Dia.) - 250 kcmil (0.58 Dia.)	1/2" [12.70]		S1012 (2) PU998 (1)	
YGHR29C58	2.14			5/8" [15.90]			
YGHR29C34	2.19			3/4" [19.00]			
YGHR29C100 ⑤	2.45			1" [25.40]			
YGHR34C58	2.14		300 kcmil (0.63 Dia.) - 500 kcmil (0.81 Dia.)	5/8" [15.90]		S1012 (2) PU998 (1)	
YGHR34C34 ⑤	2.44			3/4" [19.00]			
YGHR34C100 ⑤	2.45	1" [25.40]		S1011 (2)	P1011 (2)		

- ① 45 Series tools require PT6515 adapter to use "U" or "PU" die
- ② 46 Series tools require PUADP1 adapter to use "U" or "PU" die
- ③ When attaching connector to ground rod, ground rod must be embossed with appropriate PRECRIMP die. For connectors that must meet IEEE 837 requirements, UPRECRIMP-type precrimp dies must be used for maximum clamping retention. No precrimp needed if using S1012, P1011 or U1011 die sets.
- ⑤ These connectors cannot be installed with the 35 Series

NOTES:

The catalog numbers shown are for unplated copper connectors for use on copper clad or stainless steel ground rod. To order electro-tin plated connectors for use on galvanized steel ground rod add suffix "-TN" to the catalog number. The ground rod hole diameter is larger for galvanized steel ground rod in the tin plated connector.

Complete die catalog numbers do not always appear on the connector, sometimes it is the die index.

*Please contact Customer Service for applications requiring IEEE-837 2014.

Ground Rod ③ Dia.	PRECRIMP Dies	
1/2"	UPRECRIMP12	U2CABT
5/8"	UPRECRIMP58	
3/4"	UPRECRIMP34	

HYTAIL™ Type YGHR-C Ground Rod Connector

Type YGHR-C irreversible compression grounding connector is engineered specifically for the Telecommunications Industry for (1, 2 or 3) #2 solid, tinned or bare conductor taps. UL467 Listed. Acceptable for direct burial in earth or concrete. BURNDY® has designed this connector to meet the stringent requirements of OSHA, the National Electric Code (NEC), UL, and the Telecommunications Industry. Performance and long life are this connector's basic design guidelines.



Features & Benefits

- Tap side: 1, 2, or 3 conductors; one connector style can be used for many applications
- Material is high conductivity wrought copper extrusion, identical to conductor material, eliminating the possibility of corrosion due to dissimilar metals, additional minimizes resistance and voltage drop
- System engineered tooling has been designed to provide a reliable dependable connection
- Die index number embossed on connector after crimp completion facilitating inspectability and ensure consistently reliable and dependable connections
- Prefilled with PENETROX™ compound and individually sealed in clear polyethylene sheet ensuring the electrical integrity of finished connection by inhibiting moisture and contaminants from entering the contact area and maintaining long-term high conductivity
- UL 467 Listed, acceptable for direct burial or concrete embedded grounding applications providing quality assurance to recognized industry NEC standards from an independent party

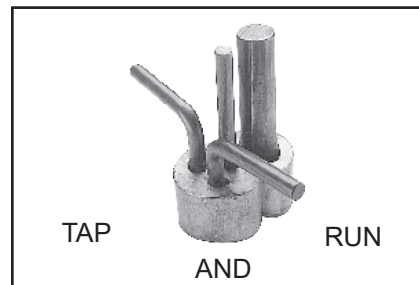
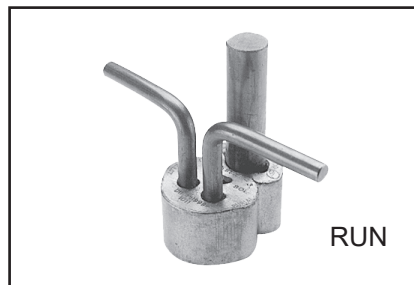
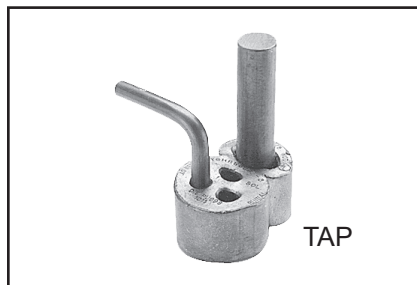
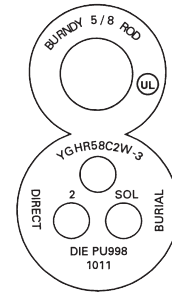

Catalog Number	Ground Rod ^③ Diameter	Tap Conductor ^⑦	Installation Tools, Die Set Catalog Number (# of Crimps)		Die Index
			750 Series 35 Series ^⑤	46 Series ^②	
YGHR58C2W-3	5/8"	#2 Sol Copper 1, 2, or 3 may be connected	PU998 (1) U1011 (2)	PU998 (1) U1011 (2) P998 (1) P1011 (2)	998/1011

Notes:

To order electro-tin plated connector for use on galvanized steel ground rod add suffix "TN" to the catalog number; The ground rod hole diameter is larger for galvanized steel ground rod in the tin plated connector

Contact BURNDY for other ground rod diameters

② 46 Series tools require PUADP1 adapter to use "U" or "PU" die

③ When attaching connector to ground rod, ground rod must be embossed with appropriate UPRECIMP58 or U2CABT Precrimp dies for maximum clamping retention. No precrimp needed if using P1011 or U1011 die sets.

⑤ The 35 Series can only use the PU998 die

⑦ Tap positions may be left void when fewer than (3) conductors are used

Ground Rod ^③ Dia.	PRECIMP Dies	
	5/8"	UPRECIMP58

HYLUG™ Type YGHA Heavy Duty Terminal

Heavy duty HYLUG™ irreversible compression terminals designed not only to carry short circuit load, but to also withstand high mechanical stress. Each conductor element has an inspection probe hole to ensure proper cable insertion. UL467 Listed. Acceptable for direct burial in earth or concrete. UL486A Listed. Prefilled with PENETROX™ compound and strip sealed.



IEEE-837*

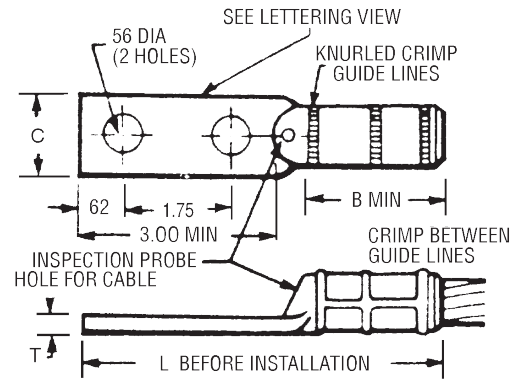

Catalog Number	Copper Conductor Size	Installation Tools, Die Set Catalog Number and (# of Crimps) 35 Series, 750 Series, 45 Series ①, 46 Series ②	B	C	L	T
YGHA2C-2N	2 AWG	U1CRT1 (1)	0.75	0.97	4.21	0.26
YGHA25-2N	1/0 AWG	U27RT (1)	0.83	0.91	4.60	0.19
YGHA26-2N	2/0 AWG	U28RT (1)	0.83	0.97	4.38	0.26
YGHA27-2N	3/0 AWG	U29RT (1)	1.18	1.08	4.94	0.29
YGHA28-2N	4/0 AWG	U30RT (2)	1.18	1.22	4.94	0.30
YGHA29-2N	250 kcmil	U31RT (2)	1.18	1.28	4.94	0.34
YGHA31-2N*	350 kcmil	U34RT (2)	1.18	1.62	5.00	0.43
YGHA34-2N	500 kcmil	U36RT (3)	1.48	1.72	5.42	0.40

① 45 Series tools require PT6515 adapter to use "U" or "PU" die
 ② 46 Series tools require PUADP1 adapter to use "U" or "PU" die
 * IEEE837 2002 Qualified
 Add -TN suffix for tin plating

HYLUG™ Type YGA Terminal

Irreversible compression HYLUG™ ground terminal specifically designed for grounding applications. Each connector has an inspection probe hole to ensure proper cable insertion. UL467 Listed. Acceptable for direct burial in earth or concrete. UL486A Listed. Prefilled with PENETROX™ compound and strip sealed.

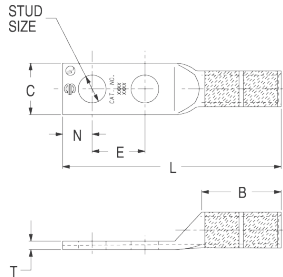

Fig.1

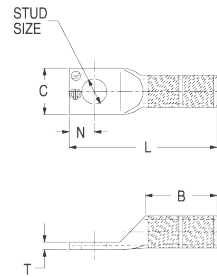
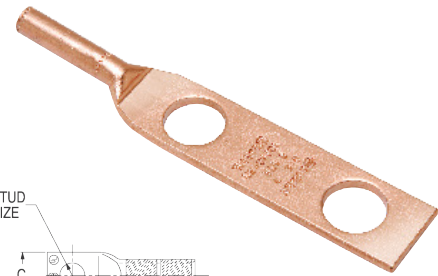

Fig.2



Catalog Number	Fig. #	Copper Conductor Size (Sol. & Str.)	Installation Tools, Die Set Cat. No. and (# of Crimps)		Stud Size	B	C	L	T	E
			Mechanical	Hydraulic						
			MD7-34R or OUR840	35 Series, 750 Series, 45 Series ①, 46 Series ②						
YGA8C-TC10	2	8 Sol./8 Str.	W8CVT (2) X8CRT (2)	U8CRT (2)	#10	0.81	0.41	1.57	0.08	—
YGA8C-TC14	2	8 Sol./8 Str.	W8CVT (2) X8CRT (2)	U8CRT (2)	1/4	0.81	0.44	1.69	0.08	—
YGA8C-TC516	2	8 Sol./8 Str.	W8CVT (2) X8CRT (2)	U8CRT (2)	5/16	0.81	0.51	1.75	0.06	—
YGA8C-2N	1	8 Sol./8 Str.	W8CVT (2) X8CRT (2)	U8CRT (2)	1/2	0.78	0.83	4.09	0.12	1.75
YGA6C-TC10	2	6 Sol./6 Str.	W5CVT (2) X5CRT (2)	U5CRT (2)	#10	1.12	0.42	1.89	0.09	—
YGA6C-TC14	2	6 Sol./6 Str.	W5CVT (2) X5CRT (2)	U5CRT (2)	1/4	1.12	0.45	2.02	0.08	—
YGA6C-TC516	2	6 Sol./6 Str.	W5CVT (2) X5CRT (2)	U5CRT (2)	5/16	1.12	0.51	2.08	0.07	—
YGA6C-2TC38E2G1	1	6 Sol./6 Str.	W5CVT (2) X5CRT (2)	U5CRT (2)	3/8	1.12	0.58	3.42	0.06	0.75
YGA6C-2N	1	6 Sol./6 Str.	W5CVT (2) X5CRT (2)	U5CRT (2)	1/2	1.09	0.83	4.40	0.12	1.75
YGA2C-2TC38	1	2 Sol./2 Str.	W2CRT (2) X2CRT (2)	U2CRT (2)	3/8	1.25	0.60	3.48	0.12	1.00
YGA2C-2N	1	2 Str.	W2CRT (2) X2CRT (2)	U2CRT (2)	1/2	1.22	0.83	4.71	0.12	1.75
YGA25-2N	1	1/0 Str.	W25VT (4) X25RT (4)	U25RT (2)	1/2	1.35	0.83	4.81	0.12	1.75
YGA26-2N	1	2/0 Str.	W26VT (4) X26RT (4)	U26RT (2)	1/2	1.45	0.81	4.97	0.12	1.75
YGA28-2N	1	4/0 Str.	W28VT (4) X28RT (4)	U28RT (2)	1/2	1.57	1.00	5.17	0.14	1.75
YGA29-2N	1	250 kcmil	W29VT (4)	U29RT (2)	1/2	1.57	1.09	5.21	0.16	1.75
YGA34-2N	1	500 kcmil	W34VT (4)	U34RT (4)	1/2	2.20	1.52	6.08	0.23	1.75

① 45 Series tools require PT6515 adapter to use "U" or "PU" die
② 46 Series tools require PUADP1 adapter to use "U" or "PU" die

GROUNDTAB for Metal Structure Grounding

(requires welding)

The BURNDY® GROUNDTAB offers a convenient attachment point for terminations of ground wires to steel structures or steel supports. The tabs are easily welded to steel, with two mounting pattern options available. The tabs are made of steel, 1/4" thick, and can be used to attach 1-hole or 2-hole terminals. Compression terminals, mechanical terminals, or SERVIT® Posts can be used to attach ground wires to steel tabs. All connection options and necessary hardware are sold separately. Often used when traditional connection methods are not practical, or when temporary grounds are required. Common applications include large generators, mobile construction site modules, housing structures built in permafrost areas, and in any metal structure requiring a permanent or temporary ground option.

Features & Benefits

- Convenient
- Can be used to attach 1-hole or 2-hole terminals
- 1/4" thick steel
- Easily welds to steel
- Offers many connection options
- Used when traditional options are not practical

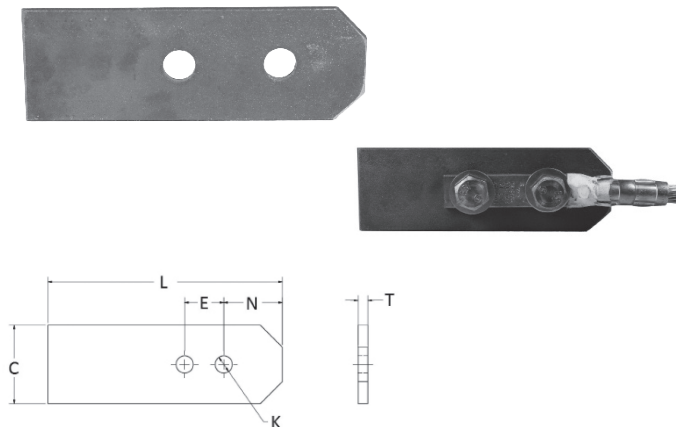

Right: Application image of GROUNDTAB used with terminals

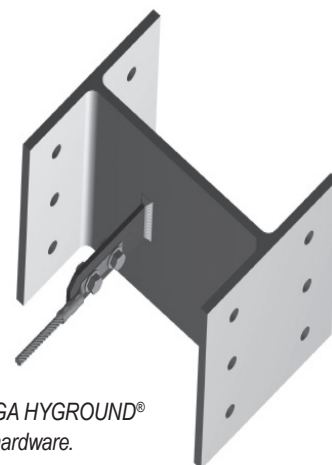

GROUNDTAB with Type YGA HYGROUND® compression terminal and hardware.

Catalog Number	L Inches	C Inches	T Inches	N Inches	No. of Holes	Hole Size (K)	Hole Spacing (E) Inches
GROUNDTAB1/2	6.00	2.00	1/4"	1.50	2	1/2"	1.75
GROUNDTAB3/8	6.00	2.00	1/4"	1.50	2	3/8"	1.00

Compression Grounding

HYGROUND® Compression System
HYLINK™ Type YGHS Heavy Duty Splice

HYLINK™ Type YGHS Heavy Duty Splice

Heavy duty HYLINK™ ground splice designed not only to carry short circuit load, but to also withstand high mechanical stress. Each conductor element has an inspection probe hole and a center stop to ensure proper cable insertion. UL467 Listed. Acceptable for direct burial in earth or concrete. UL486A Listed. Prefilled with PENETROX™ compound and strip sealed.



IEEE-837*

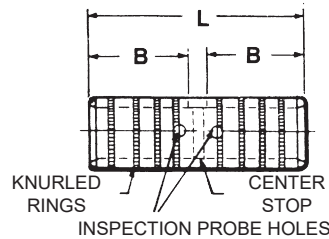

Catalog Number	Copper Conductor Size	Installation Tools, Die Set Catalog Number and (# of Crimps) 35 Series, 750 Series, 45 Series ①, 46 Series ②	B	L
YGHS2C	2 AWG	U1CRT1 (1)	0.75	1.73
YGHS25	1/0 AWG	U27RT (1)	0.83	1.89
YGHS26	2/0 AWG	U28RT (1)	0.83	1.89
YGHS27	3/0 AWG	U29RT (1)	1.18	2.59
YGHS28	4/0 AWG	U30RT (2)	1.18	2.59
YGHS29	250 kcmil	U31RT (2)	1.18	2.59
YGHS31*	350 kcmil	U34RT (2)	1.18	2.59
YGHS34	500 kcmil	U36RT (3)	1.48	3.19

① 45 Series tools require PT6515 adapter to use "U" or "PU" die
 ② 46 Series tools require PUADP1 adapter to use "U" or "PU" die
 * IEEE837 2002 Qualified

HYLINK™ Type YGS Splice

Irreversible compression HYLINK™ ground splices specifically designed for grounding applications. Each conductor element has an inspection probe hole and a center stop to ensure proper cable insertion. UL467 Listed. Acceptable for direct burial in earth or concrete. UL486A Listed. Prefilled with PENETROX™ E compound and strip sealed.

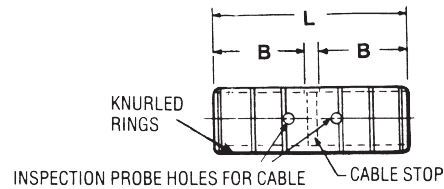

Catalog Number	Copper Conductor Size	Installation Tools, Die Set Catalog Number and (# of Crimps)				B	L
		Mechanical			Hydraulic		
		Y1MRTC	MD734R	OUR840	35 Series, 750 Series, 45 Series ①, 46 Series ②		
YGS8C	8 Sol./Str.	Red (2)	W8CRT, W8CVT	X8CRT	U8CRT (2)	0.78	1.75
YGS6C	6 Sol./Str.	Blue (2)	W5CRT, W5CVT	X5CRT	U6CRT (2)	1.09	2.38
YGS2C	2 Sol./Str.	Brown (4)	W2CVT (2)	X2CVT (2)	U2CRT (2)	1.22	2.67
YGS25	1/0 Sol./Str.	—	W25VT (4)	X25RT (4)	U25RT (2)	1.35	2.97
YGS26	2/0 Str.	—	W26VT (4)	X26RT (4)	U26RT (2)	1.45	3.13
YGS28	4/0 Str.	—	W28VT (4)	X28RT (4)	U28RT (2)	1.57	3.37
YGS29	250 kcmil	—	W29VT (4)	—	U29RT (2)	1.57	3.37
YGS34	500 kcmil	—	W34VT (4)	—	U34RT (4)	2.20	4.63

① 45 Series tools require PT6515 adapter to use "U" or "PU" die
 ② 46 Series tools require PUADP1 adapter to use "U" or "PU" die

Type YGF Grounding Plate

The irreversible compression ground plate is designed to withstand the rigors of concrete construction. The ground plates are made of high strength, high-conductivity cast copper alloy body with a pure wrought copper compression element. In addition to the tapped NEMA size holes and spacing on the face, the plate comes with a tapped hole on the underside for ease of positioning prior to pouring the concrete. UL467 Listed. Acceptable for direct burial in earth or concrete. Prefilled with PENETROX™ compound and strip sealed.

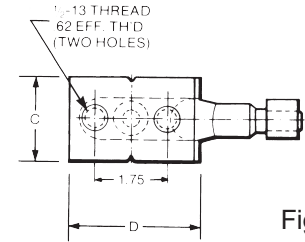
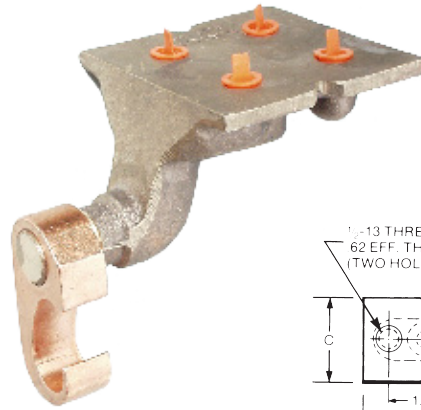

Fig. 1

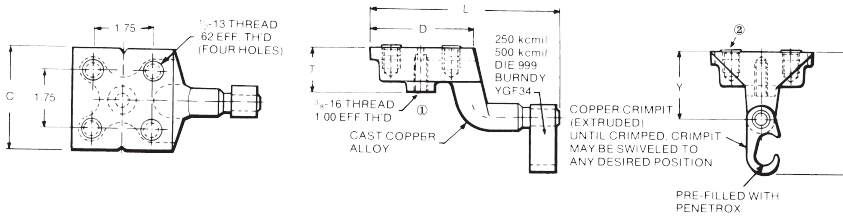

Fig. 2

NOTES:

- ① This tapped hole may be used to position the grounding plate on a threaded rod prior to placement of the concrete. 3/8-16 thread with 1.00 EFF. Thread is standard. If other thread is required, add appropriate suffix code to catalog number. -50 (1/2-13, .94 EFF. Thread), -62 (5/8-11, .94 EFF. Thread) and -75 (3/4-10, .81 EFF. Thread) Example: YGF34-4N-50 is YGF34-4N with 1/2-13 Thread
- ② Plastic plugs are provided to keep dirt out of the threaded holes until the attachment of grounding terminals

Catalog Number	Fig. #	C	D	H	L	T	Y	Copper Conductor Range	Tapped Holes		Installation Tools, Die Set Cat. No., and (# of Crimps)		
									Size	Hole Centers	35 Series, 750 Series	45 Series ①	46 Series ②
YGF29-2N	1	2.00	3.25	3.62	5.78	1.31	2.00	2 AWG-250 kcmil	1/2 - 13	1-3/4	U997 (1)	U997 (1)	U997 (1)
YGF29-4N	2	3.25	3.25	3.62	5.78	1.31	2.00	2 AWG-250 kcmil	1/2 - 13	1-3/4	U997 (1)	U997 (1)	U997 (1)
YGF34-2N ③	1	2.00	3.25	4.62	5.40	1.31	2.19	250 kcmil-500 kcmil	1/2 - 13	1-3/4	U1011 (3)	S1011 (2)	P1011 (2)
YGF34-4N ③	2	3.75	3.75	4.62	5.90	1.31	2.19	250 kcmil-500 kcmil	1/2 - 13	1-3/4	U1011 (3)	S1011 (2)	P1011 (2)

① 45 Series tools require PT6515 adapter to use "U" or "PU" die
 ② 46 Series tools require PUADP1 adapter to use "U" or "PU" die
 ③ These connectors can only be installed using the 750, 45, or 46 series of tools.
 *Please contact Customer Service for applications requiring IEEE-837 2014.

GROUNDLINK™ Type YGIB for Structural steel angled or parallel beam

An irreversible compression ground connection which allows attachment to a structural steel standard (angled) or wide flange (parallel) beam. Installed with a required 5-piece die set, Catalog PIBEAMKIT or UIBEAMKIT. Die index 1105. GROUNDLINK™ connectors are made of high-conductivity wrought copper and come pre-filled with PENETROX™ E compound and strip sealed. Order terminal mounting hardware separately.

NOTES:

Terminal connector to be ordered separately. When I-beam connector is used with type YGHA terminal, the connection meets IEEE 837. YGA-2N, YA-2N and other BURNDY® 2-hole NEMA copper terminals are suitable.

Order TMHG Terminal Mounting Hardware Kit separately. Kit consists of 2 studs, 2 flat washers, 2 lockwashers and 2 hex nuts.

Using the 1/4 hex key wrench, screw the stud into the connector until stud bottoms out in connector. Install a YGHA terminal, flat washer, lockwasher and hex nut onto stud. Tighten and torque to 480 pound-inches.

Dimensions shown in i-Beam Flange Thickness column reflect the minimum dimensions required on a beam to properly install the i-Beam connector.

To correctly determine the appropriate YGIB connector to use based on flange thickness, order either YGIBGAUGE1 or YGIBKIT1 (KIT1 contains WIREMIKE).

*Please contact Customer Service for applications requiring IEEE-837 2014.



IEEE-837*

Connector shipped with thread protection studs only. Order TMHG kits separately.

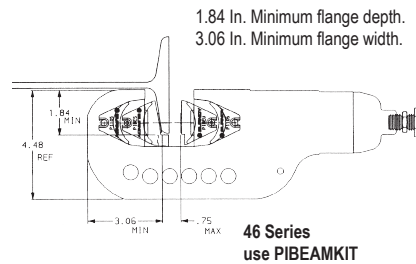

Fig. 1

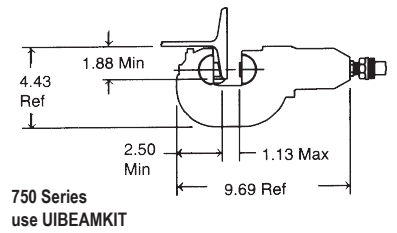
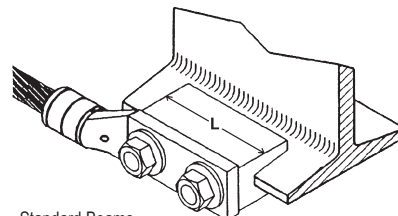
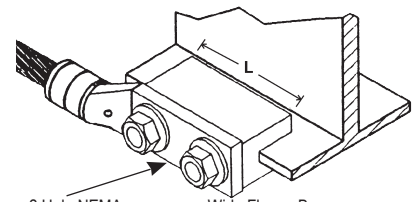

Fig. 2



Standard Beams
 (Flange Angled) use YGIBS



2 Hole NEMA Spacing
 Wide Flange Beams
 (Flange Parallel) use YGIBW

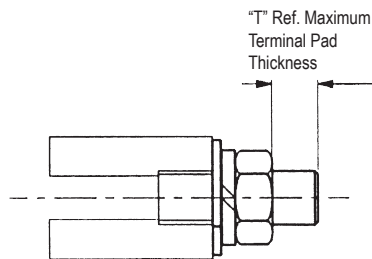

TERMINAL MOUNTING HARDWARE

Catalog Number	"T"
TMHG42	0.42
TMHG92	0.92

NOTE: Use TMHG-92 to double stack lugs.

GROUNDLINK™ Type YGIB (Continued)

Catalog Number	Copper Conductor Size	Fig. #	L	J	I-Beam Flange Thickness	Suggested Terminals		T
						Copper Conductor	Terminal	
YGIBS28-338-2N	2 AWG-4/0 AWG	1	3.00	1/2-13	0.250" - 0.338"	#2 Str. AWG	YGHA2C-2N	0.26
						1/0 Str. AWG	YGHA25-2N	0.19
YGIBW28-338-2N	2 AWG-4/0 AWG	2	3.00	1/2-13		2/0 Str. AWG	YGHA26-2N	0.26
						4/0 Str. AWG	YGHA28-2N	0.30
YGIBS34-338-2N	250 kcmil-500 kcmil	1	6.00	1/2-13		250 kcmil	YGHA29-2N	0.34 0.40
YGIBW34-338-2N	250 kcmil-500 kcmil	2	6.00	1/2-13		500 kcmil	YGHA34-2N	0.34 0.40
YGIBS28-400-2N	2 AWG-4/0 AWG	1	3.00	1/2-13	0.338" - 0.400"	#2 Str. AWG	YGHA2C-2N	0.26
						1/0 Str. AWG	YGHA25-2N	0.19
YGIBW28-400-2N	2 AWG-4/0 AWG	2	3.00	1/2-13		2/0 Str. AWG	YGHA26-2N	0.26
						4/0 Str. AWG	YGHA28-2N	0.30
YGIBS34-400-2N	250 kcmil-500 kcmil	1	6.00	1/2-13		250 kcmil	YGHA29-2N	0.34 0.40
YGIBW34-400-2N	250 kcmil-500 kcmil	2	6.00	1/2-13		500 kcmil	YGHA34-2N	0.34 0.40
YGIBS28-462-2N	2 AWG-4/0 AWG	1	3.00	1/2-13	0.400" - 0.462"	#2 Str. AWG	YGHA2C-2N	0.26
						1/0 Str. AWG	YGHA25-2N	0.19
YGIBW28-462-2N	2 AWG-4/0 AWG	2	3.00	1/2-13		2/0 Str. AWG	YGHA26-2N	0.26
						4/0 Str. AWG	YGHA28-2N	0.30
YGIBS34-462-2N	250 kcmil-500 kcmil	1	6.00	1/2-13		250 kcmil	YGHA29-2N	0.34 0.40
YGIBW34-462-2N	250 kcmil-500 kcmil	2	6.00	1/2-13		500 kcmil	YGHA34-2N	0.34 0.40
YGIBS28-550-2N	2 AWG-4/0 AWG	1	3.00	1/2-13	0.462" - 0.550"	#2 Str. AWG	YGHA2C-2N	0.26
						1/0 Str. AWG	YGHA25-2N	0.19
YGIBW28-550-2N	2 AWG-4/0 AWG	2	3.00	1/2-13		2/0 Str. AWG	YGHA26-2N	0.26
						4/0 Str. AWG	YGHA28-2N	0.30
YGIBS34-550-2N	250 kcmil-500 kcmil	1	6.00	1/2-13		250 kcmil	YGHA29-2N	0.34 0.40
YGIBW34-550-2N	250 kcmil-500 kcmil	2	6.00	1/2-13		500 kcmil	YGHA34-2N	0.34 0.40
YGIBS28-613-2N	2 AWG-4/0 AWG	1	3.00	1/2-13	0.550" - 0.613"	#2 Str. AWG	YGHA2C-2N	0.26
						1/0 Str. AWG	YGHA25-2N	0.19
YGIBW28-613-2N	2 AWG-4/0 AWG	2	3.00	1/2-13		2/0 Str. AWG	YGHA26-2N	0.26
						4/0 Str. AWG	YGHA28-2N	0.30
YGIBW34-613-2N	250 kcmil-500 kcmil	2	6.00	1/2-13		500 kcmil	YGHA34-2N	0.34 0.40
YGIBS28-675-2N	2 AWG-4/0 AWG	1	3.00	1/2-13	0.613" - 0.675"	#2 Str. AWG	YGHA2C-2N	0.26
						1/0 Str. AWG	YGHA25-2N	0.19
YGIBW28-675-2N	2 AWG-4/0 AWG	2	3.00	1/2-13		2/0 Str. AWG	YGHA26-2N	0.26
						4/0 Str. AWG	YGHA28-2N	0.30
YGIBS34-675-2N	250 kcmil-500 kcmil	1	6.00	1/2-13		250 kcmil 500 kcmil	YGHA29-2N	0.34 0.40
YGIBW34-675-2N	250 kcmil-500 kcmil	2	6.00	1/2-13		500 kcmil	YGHA34-2N	0.34 0.40
YGIBW28-750-2N	2 AWG-4/0 AWG	3	3.00	1/2-13	0.690" - 0.750"	4/0 Str. AWG	YGHA28-2N	0.30
YGIBW28-1000-2N	2 AWG-4/0 AWG	3	3.00	1/2-13	1.000" - 1.060"	2/0 Str. AWG	YGHA2C-2N	0.26
						4/0 Str. AWG	YGHA28-2N	0.30

VERSITAIL™ Type GSTUD-HY Structural Steel Grounding Connector

INSTALLATION

1. Weld the VERSITAIL™ to the steel member
2. Select the proper connector for your specific application

FOR COMPRESSION CONNECTORS

Select the proper HYGROUND® Type YGHP connector. Clean the conductor, join the VERSITAIL™ and the grounding conductor together with the recommended tool and die set, then crimp the connector over the knurled area of the VERSITAIL™ connector.

FOR MECHANICAL CONNECTORS

Select the properly sized BURNDY® mechanical connector. Clean the conductor, apply PENETROX™ E oxide inhibiting compound on the contact area for increased effectiveness and service life. Put the connector over the knurled area of the VERSITAIL™ connector and apply the recommended torque value for correct installation.

Features & Benefits

- The VERSITAIL™ may be welded to steel surfaces quickly and easily with normal construction equipment
- The VERSITAIL™ eliminates costly disk grinding and the need to expose virgin metal, the welding process burns through the oxidation and "scale" to establish excellent electrical grounding continuity
- The VERSITAIL™ may be installed by the welder in the field or at the steel fabricator based on customer preference
- The VERSITAIL™ pure copper coating over low carbon, hot rolled steel is compatible with standard welding processes, no toxic gasses are generated
- The VERSITAIL™ has a knurled surface, copper plated and specifically designed to ensure excellent mechanical gripping and electrical integrity for BURNDY® compression and mechanical connectors in all grounding applications
- The VERSITAIL™ may be installed in all weather conditions, eliminating costly construction delays
- Low installation cost
- No drilling
- No cleaning
- No special preparation
- Low carbon, hot rolled steel

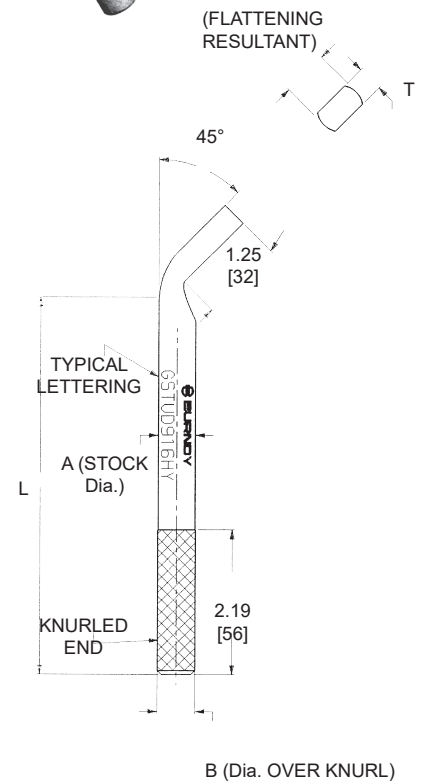
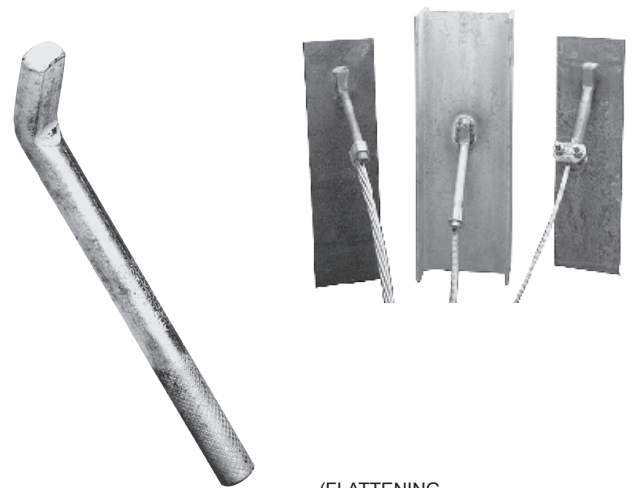

Catalog Number	Nom Rod Size	A	B	L	T	Electrical Equivalent Copper Conductor Size (AWG)*
GSTUD14HY	1/4"	0.25	0.26	4.81	0.19	#6
GSTUD38HY	3/8"	0.38	0.39	5.81	0.25	#3
GSTUD916HY	9/16"	0.56	0.57	5.68	0.38	1/0
GSTUD34HY	3/4"	0.75	0.76	5.81	0.51	4/0

* This is the equivalent rating for continuous service.
 Large conductors may be connected using both compression and bolted connectors in potential ground fault applications.

Compression Grounding

HYGROUND® Compression System
Types YGT, YTTAG, Static Grounding Receptacles

Types YGT, YTTAG Static Grounding Receptacles

The types YGT and YTTAG static grounding receptacles are designed for static grounding of equipment. The receptacle is connector to the ground grid with HYGROUND® compression connectors and finished flush with surface to provide a permanent, corrosion proof, grounding point.



Type YGT
Static Grounding Receptacle
with Cover

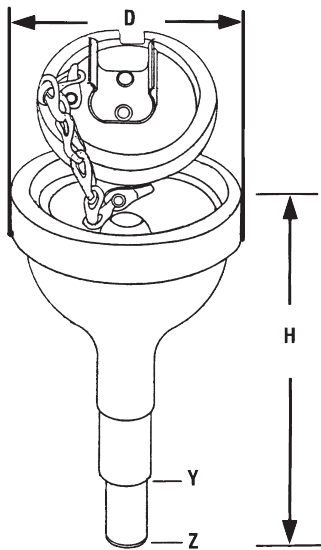

Fig. 1

Type YTTAG Combination
Static Grounding Receptacle
and Aircraft Tie Down Bar

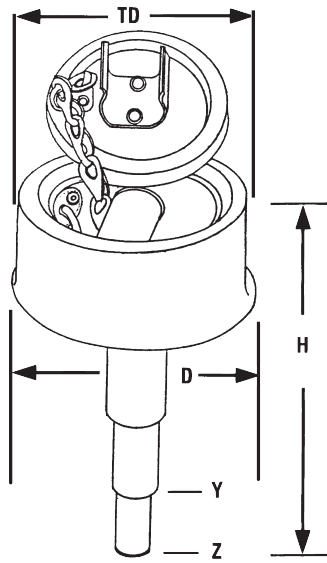

Fig. 2

Catalog Number	Fig. #	HYGROUND® Connector	H	D	Y Dia	Z Dia	TD
YGT275	1	Select suitable YGHR, YGHP or YGLR for 3/4" ground rod and sized to ground conductor.	5.50	2.75	0.75	0.56	-
YTTAG388	2		6.50	4.75	0.75	0.56	4.30

NOTES:

Install YGHR, YGHP or YGLR on Hub Y. Hub Z is inserted into 1/2" rigid conduit. The conduit is driven into the earth to provide support and provide correct level of receptacle prior to cement pour.

Type YG-B Connector for Structural Steel or Bus Bar

The BURNDY® YG-B series of compression connectors are ideally suited for bus bar, cell tower structures, structural steel, and steel infrastructure such as equipment supports, steel railings and ladders.

These high conductivity copper connectors allow attachment of a ground conductor to structural steel, rail or bus bar, with just one crimp using a BURNDY® 750-style HYPRESS™ head. The exclusive design allows the user to attach tap conductor(s) to 1/8" to 9/16" thick rail, bus bar, or flat steel.

Most connectors are suitable for 1 or 2 conductors for power or grounding and bonding applications. Prefilled with PENETROX™ compound with the addition of a grit material and strip sealed.

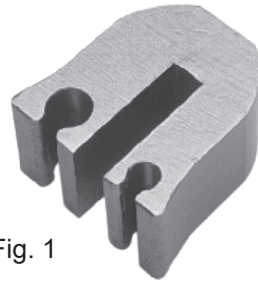

Fig. 1



Fig. 2



Fig. 3

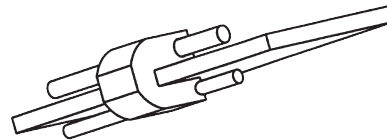
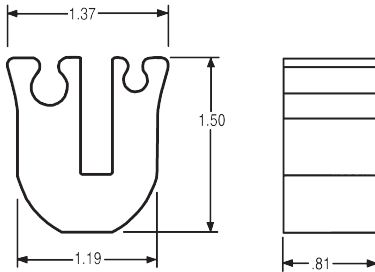

Catalog Number	Figure #	Steel / Bar Thickness	Tap Conductor(s) Accommodated	Tooling	Installation Die	# of Crimps
YG14B2TC2C6C ①	1	1/4"	#2 Sol. and/or Str. Copper #6 Sol. and/or Str. Copper	750 Series	U1105	1
YG14B2TC2C2C ②	2	1/4"	#2 AWG - #2 AWG Copper	750 Series	U1105	1
YG14BTC28 ③	3	1/8" - 1/4"	4/0 AWG Str. to 1/0 AWG Str. Copper	750 Series	U1105	1

For Tin Plating add the -TP suffix.

- ① UL Listed, CSA Certified, Rated for Direct Burial; can accept 1 or 2 conductors
- ② U-shaped tap groove can only be used with #2 Solid wire; can accept 1 or 2 conductors; suitable for continuous uncut conductor applications
- ③ cULus listed, Rated for Direct Burial; can accept only 1 conductor

HammerTap Ground Rod Clamp

The Burndy HammerTap offers an irreversible ground rod connection. This durable design is UL 467 listed for wire to ground rod. No special tools or training are needed for installation. The connection can be made easily using just a hammer.

Features and Benefits:

- Irreversible connection option without having to weld and does not require special tooling
- Minimal training required
- Provides a visual verification that the connection is safely installed correctly
- Fast, easy, and safe connections that can be made in any environment using just a hammer
- Can be used as a termination or a "T" (pass-through) ground rod connection

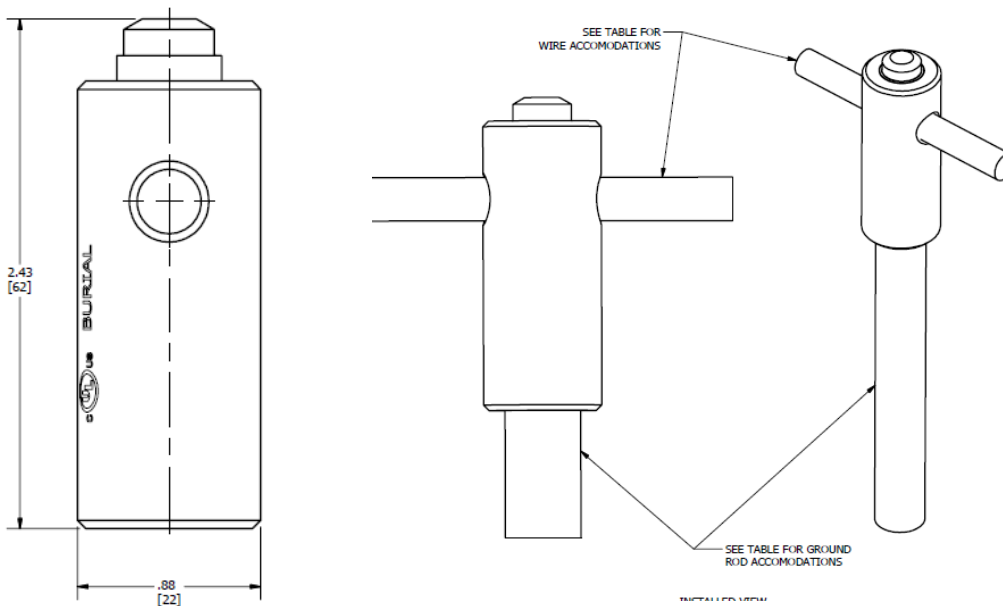
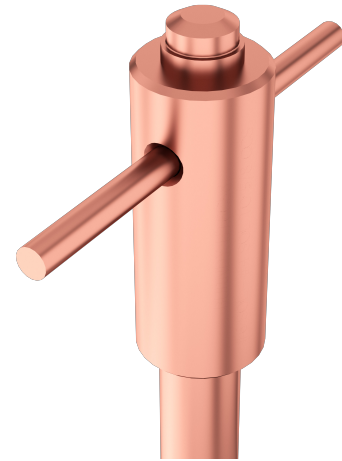

Catalog Number	Ground Rod Size	Wire Range Accommodated	Number of Conductors
HT6C58	5/8"	#6 Solid - #4 Solid	1
HT2C58	5/8"	#4 Stranded - #2 Stranded	1

Type BFB

Industry-exclusive Compression Solution for Flexible Bus Bar Applications.

The BFB terminal lugs are an innovative compression solution for connecting the ends of flexible bus bar. Offering a faster, safer, and cleaner alternative to methods used today, these lugs are compatible with most sizes of flexible bus bar. Installed with the 750 Series of 12-ton crimp tools with specifically designed UBFB-style dies.

Typically used in panel boards, switchboards, transformers and similar applications, flexible bus bar is gaining popularity. After the flexible bus bar has been shaped and customized for the application at hand, it must be connected to the structure. Typical installation methods rely on drilling (time consuming with a risk of inaccuracy of customized stud holes), punching (which can distort the shape of the conductor), and welding (can be hazardous and requires specific training). Utilizing the new BFB terminal lugs requires No Drilling, No Punching, and No Welding for proper, inspectable installation.

Features & Benefits



- Industry Exclusive! Only offered by BURNDY®
- Eliminates the need to drill through copper sheets, ensuring a cleaner, faster installation
- Full inspectability with the BURNDY® Engineered System
- 1-hole and 2-hole options available to accommodate spacing requirements
- Most flexible bus bar sizes accommodated
- Locator lines on terminals provide for accurate and consistent crimping
- UL Recognized to UL67 for Panelboard Equipment

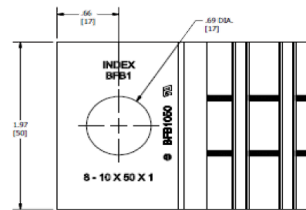
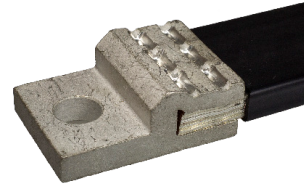

Figure 1

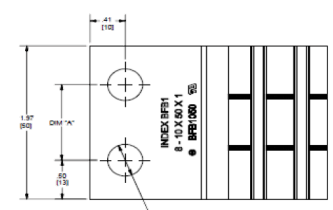
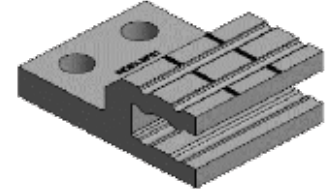
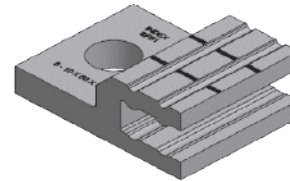

Figure 2



Catalog Number	Figure	Flex Bar Accommodation	# holes	Stud Size	A Dimension (in)	Die Catalog Number with 750 Series tooling only (# Crimps)
		# sheets x sheet width (mm) x thickness (mm)				
BFB620T12	1	4X20X1 - 6X20X1	1	1/2"	—	UBFB2024 (2)
BFB1020T12	1	8X20X1 - 10X20X1	1	1/2"	—	UBFB2024 (2)
BFB624T12	1	4X24X1 - 6X24X1	1	1/2"	—	UBFB2024 (2)
BFB1024T12	1	8X24X1 - 10X24X1	1	1/2"	—	UBFB2024 (2)
BFB632T12	1	4X32X1 - 6X32X1	1	1/2"	—	UBFB1 (2)
BFB1032T12	1	8X32X1 - 10X32X1	1	1/2"	—	UBFB1 (2)
BFB640T58	1	4X40X1 - 6X40X1	1	5/8"	—	UBFB1 (3)
BFB1040T58	1	8X40X1 - 10X40X1	1	5/8"	—	UBFB1 (3)
BFB650T58	1	4X50X1 - 6X50X1	1	5/8"	—	UBFB1 (3)
BFB1050T58	1	8X50X1 - 10X50X1	1	5/8"	—	UBFB1 (3)
BFB6402TH38E26	2	4X40X1 - 6X40X1	2	3/8"	0.97	UBFB1 (3)
BFB10402TH38E26	2	8X40X1 - 10X32X1	2	3/8"	0.97	UBFB1 (3)
BFB10402TH38E27	2	8X40X1 - 10X32X1	2	3/8"	0.89	UBFB1 (3)
BFB6502TH38E26	2	4X50X1 - 6X50X1	2	3/8"	0.97	UBFB1 (3)
BFB10502TH38E26	2	8X50X1 - 10X50X1	2	3/8"	0.97	UBFB1 (3)
BFB10502TH38E27	2	8X50X1 - 10X50X1	2	3/8"	0.89	UBFB1 (3)

Table of Contents

Mechanical Grounding Connectors Overview	E-31
Types KC, K2C SERVIT POST™ Connectors (cable to flat).....	E-31
Type KCKF Bulkhead Ground Connector.....	E-32
Types KC-J12, EQC632C1 Transformer Ground Connectors.....	E-33
SERVIT® Type KS Split Bolt Connectors.....	E-33
Type GRC High Strength Ground Rod Clamp for Copper Cable to Rod.....	E-34
Type GCRT1/0 Ground Clamp Range Taking up to 1/0.....	E-34
Type GRL Light Duty Economical Ground Rod Clamp.....	E-34
Type GKA Connector for Copper.....	E-35
Type KPB Connector for Copper.....	E-35
QIKLUG™ Types CL50-1, CL50-1TN Copper Lay-in Connectors.....	E-36
QIKLUG™ Type CL Copper Lay-in Connectors.....	E-36
The CONSTRICTOR® Type GCS-HEX Ground Connector to Steel.....	E-37
Types GCSYA-WEEB, GCS2YA Tower Ground Clamps.....	E-38
Type GAR for Parallel or 90° Copper Cable Connection to Rod or Pipe.....	E-39
Types GAR-BU, GAR3902 Ground Connectors.....	E-42
Type GAR-TC Water Pipe Ground Connector.....	E-43
Type GD Two Copper Cables to Rod or Tube.....	E-44
Type GP Two Copper Cables to Rod, Pipe, or Column.....	E-45
Type GK Three Copper Cables to Rod or Pipe.....	E-46
Type GG Ground Connector for Copper Bar, Strap, Braid, Cable to Rod or Tube.....	E-47
Type FFG Fence Fabric Ground Clamps.....	E-48
Type GA-H Copper Cable to "H" Beam or Square Fence Post.....	E-49
Type GA-H30SS Copper Cable to Square Fence Post.....	E-50
Festoon Grounding System Kits.....	E-50
Type GQ Ground Connector for Copper Cable to Tube.....	E-52
Type GX Ground Connector for Copper Cables.....	E-52
CPI Ground Grid Connectors.....	E-53
Water Pipe Grounding; Miscellaneous Cast Bronze Clamps.....	E-55
Type GC-A Dual Rated Ground Clamp for Copper and Aluminum.....	E-60
BONDIT® Intersystem Bonding Connector Type BDT (House or Meter Socket Mounted).....	E-61
BONDIT® Intersystem Bonding Connector Type BDTIBB (Wall Mount).....	E-62
HandyBug™ Type SB Connectors (tap, splice or terminate).....	E-63
Type BWB680 Series Pool Water Bonding Kits.....	E-64
BARTAP™ Type QGFL Copper Cable to Flat Bar or Pad.....	E-65
Type GNAH Grounding Terminal.....	E-65
Types J, RGC Mechanical Rail Connectors.....	E-66
CPI Running Rail Connectors.....	E-67
CPI Contact Rail Connectors.....	E-68
CPI 2000 kcmil Cathode Connector.....	E-69
CPI Single Cable Support Spring Rail Clips.....	E-70
Types GB, GBM Ground Connector Copper Cable to Bar.....	E-71
Types GC, GCM Ground Connector Two Copper Cables to Bar.....	E-71
Type GL Ground Connector Two Copper Cables to Bar.....	E-72
Type GZ Ground Connector Copper Cable to Bar.....	E-72
Type GIE-G Heavy Duty Construction Ground Connector for Vehicle Grounding.....	E-73
Type BSD Static Discharge Reels.....	E-74
Type BSDCCEE Static Discharge "C" Clamp.....	E-75
STUDBUG™ Type GCB63T13G1 for Static Grounding Applications.....	E-75
Type GSC75 All-in-one Ball & Socket Design with NEMA Pad.....	E-76
Type GSC63 Ground Ball Stud with 90° NEMA Pad.....	E-76
Type GC-CT Cable Tray Ground Clamp.....	E-77
Type BTCGC Clamp for Aluminum or Steel Cable Tray.....	E-77
SUPER-CLAMP™ Type GXP1828RF Raised Floor/Rebar Ground Connector.....	E-78
UNIGROUND™ Type GRF Raised Floor Grounding Connector.....	E-79
Types GP-G1, GP-RT Raised Floor Grounding Clamps.....	E-80

Flexible Copper Braid Jumper

General Information.....	E-81
Current Carrying Capacity.....	E-81
Bulk Braid.....	E-81
Custom Designs and Custom Variations.....	E-82
Type B 1-Hole Ferrule End.....	E-83
Type B 2-Hole Ferrule End.....	E-84
Type BB-ML-TN 1-Hole Ferrule End.....	E-86
Type BB-LT 1-Hole Connector End.....	E-88
Types CCY, B-B Covered Jumpers.....	E-89
Type BB-SS Stainless Steel Braid.....	E-90
Type B Undrilled Ferrules.....	E-91
Type B-4N 4-Hole NEMA Cable Tray Bonding Straps.....	E-92 E-94
Type BGRK Grounding Kits.....	E-95
Type BBB Copper Bus Bar.....	E-99
Bus or Ground Bars	
Copper, Tinned Copper, and Stainless Steel.....	E-101
Types CB, TCB, SSB.....	E-102
Type CB (Pattern S) 2" Telecom Bus or Ground Bar.....	E-105
Type CB (Pattern S) 4" Telecom Bus or Ground Bar.....	E-106
Type CB (Pattern Y) NEMA Hole Pattern Bus or Ground Bar.....	E-107
Type CB (FAA-Suffix) FAA Ground Plate Options.....	E-108
Type CB (Patterns J and M) Ground Bar.....	E-109
Type CB (Pattern P) Ground Bar.....	E-110
Standoff Insulators (Red).....	E-110
Mounting Brackets.....	E-110
Perimeter Bar.....	E-111
Perimeter Bus Bars, NN and NH Patterns.....	E-112
GRIDMAX® Grounding Personnel Safety Mats.....	E-113

Most frequently ordered catalog numbers are highlighted in BLUE

Mechanical Grounding Connectors Overview

More than 60 years of technological innovation has made BURNDY® mechanical grounding connectors one of the most widely used and highly respected lines in the industry. There is virtually no grounding application challenge that this diversified line cannot help solve.

All BURNDY mechanical grounding connectors have been designed for easy installation and outstanding durability. Only the finest high copper alloys are used in their manufacture, ensuring top performance under the most extreme environmental conditions.

Types KC, K2C SERVIT POST™ Connectors for cable to flat

SERVIT POST™ connectors are used to ground one or two cables to steel structures, fence posts, and transformers amongst other things. Also these connectors can be used to tap one or two cables from bus bar. One-wrench installation.

- UL467 Listed for the US and Canadian markets.

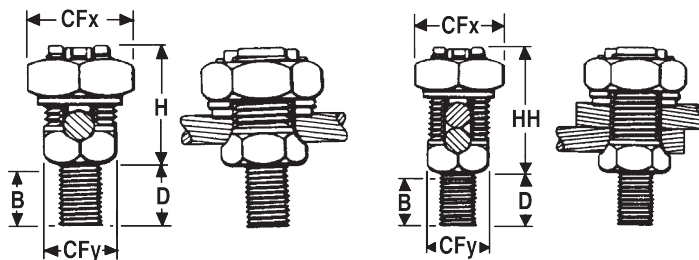

KC - 1 wire

K2C - 1 to 2 wires



TYPE KC One Wire	TYPE K2C One or Two Wires	Stranded	Solid	Stud Diameter	B	CFx	CFy	D	H	HH
KC15	K2C15	12 AWG-9 AWG	12 AWG-8 AWG	1/4-20	3/8	1/2	3/8	1/2	5/8	7/8
KC15B1	K2C15B1	12 AWG-9 AWG	12 AWG-8 AWG	1/4-20	7/8	1/2	3/8	1	5/8	7/8
KC17	K2C17	10 AWG-7 AWG	10 AWG-6 AWG	1/4-20	3/8	5/8	7/16	1/2	7/8	1
KC17B1	K2C17B1	10 AWG-7 AWG	10 AWG-6 AWG	1/4-20	7/8	5/8	7/16	1	7/8	1
KC20	K2C20	10 AWG-5 AWG	10 AWG-4 AWG	5/16-18	13/32	11/16	1/2	5/8	7/8	1-1/8
KC20B1	K2C20B1	10 AWG-5 AWG	10 AWG-4 AWG	5/16-18	27/32	11/16	1/2	1	7/8	1-1/8
KC22	K2C22	10 AWG-3 AWG	10 AWG-2 AWG	3/8-16	15/32	3/4	5/8	5/8	1	1-1/4
KC22B1	K2C22B1	10 AWG-3 AWG	10 AWG-2 AWG	3/8-16	31/32	3/4	5/8	1-1/8	1	1-1/4
KC23	K2C23	8 AWG-2 AWG	10 AWG-1 AWG	3/8-16	15/32	13/16	5/8	5/8	1	1-3/8
KC23B1	K2C23B1	8 AWG-2 AWG	10 AWG-1 AWG	3/8-16	31/32	13/16	5/8	1-1/8	1	1-3/8
KC25	K2C25	2 AWG-1/0 AWG	2 AWG-2/0 AWG	1/2-13	9/16	15/16	3/4	3/4	1-1/8	1-5/8
KC25B1	K2C25B1	2 AWG-1/0 AWG	2 AWG-2/0 AWG	1/2-13	1-1/16	15/16	3/4	1-1/4	1-1/8	1-5/8
KC26	K2C26	2 AWG-2/0 AWG	2 AWG-3/0 AWG	1/2-13	17/32	1	7/8	3/4	1-3/8	1-7/8
KC26B1	K2C26B1	2 AWG-2/0 AWG	2 AWG-3/0 AWG	1/2-13	1-1/16	1	7/8	1-1/4	1-3/8	1-7/8
KC28	K2C28	1 AWG-4/0 AWG	1 AWG-4/0 AWG	5/8-11	3/4	1-1/2	1-3/16	1	1-3/4	2-1/4
KC28B1	K2C28B1	1 AWG-4/0 AWG	1 AWG-4/0 AWG	5/8-11	1-1/4	1-1/2	1-3/16	1-1/2	1-3/4	2-1/4
—	K2C28G3	1 AWG-4/0 AWG	1 AWG-4/0 AWG	1/2-13	1-1/4	1-1/2	1-3/16	1-1/2	1-3/4	2-1/4
KC31	K2C31	1 AWG-350 kcmil	N/A	5/8-11	3/4	1-11/16	1-3/8	1	2-1/4	2-7/8
KC31B1	K2C31B1	1 AWG-350 kcmil	N/A	5/8-11	1-1/4	1-11/16	1-3/8	1-1/2	2-1/4	2-7/8
KC34	K2C34	3/0 AWG-500 kcmil	N/A	3/4-10	1	2	1-5/8	1-1/4	2-3/8	3-1/4
KC34B1	K2C34B1	3/0 AWG-500 kcmil	N/A	3/4-10	1-1/2	2	1-5/8	1-3/4	2-3/8	3-1/4

Note:

Use KF or K2F designation for female SERVIT POST™

Add suffix -NSP to catalog numbers to have connector supplied with split lockwasher and nut

Type KCKF

Bulkhead Ground Connector

The "Bulkhead" connector is designed to allow a ground wire to be connected from the inside of a box or enclosure to the outside of a box or enclosure.

This new connector is supplied in kit form with a male SERVID POST™, female SERVID®, (2) stainless steel washers, split lock washer and sealing washer.

The available "Application Guideline" document helps describe the application with visuals and installation examples.

Features & Benefits

- Provides an easy way to connect ground wires "through" an enclosure wall
- Includes Male SERVID POST™, Female SERVID®, (2) Stainless Steel Washers, Split Lock Washer, Sealing Washer
- Split Lock Washer allows adjustment of conductor orientation
- Made of Silicon Bronze material (connectors) and Stainless Steel Hardware, Sealing Washer
- Meets NEMA 4X requirements when installed correctly
- Application Guideline document available
- Industry-proven split bolt/SERVID POST™ technology
- UL467 Listed for the US and Canadian Markets

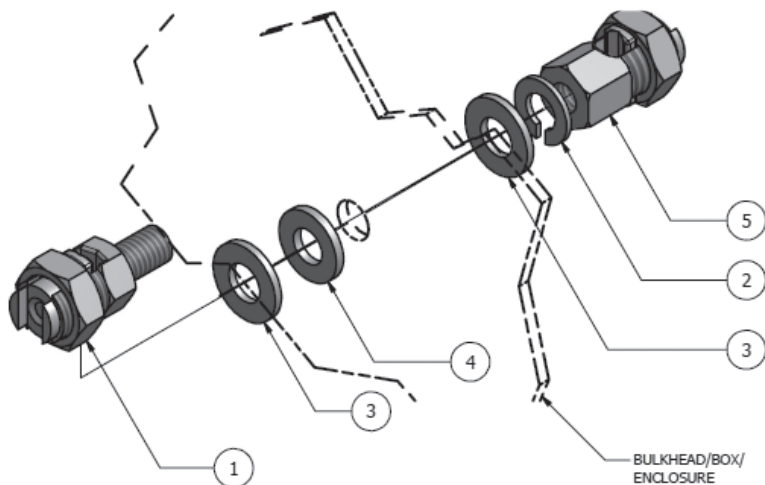
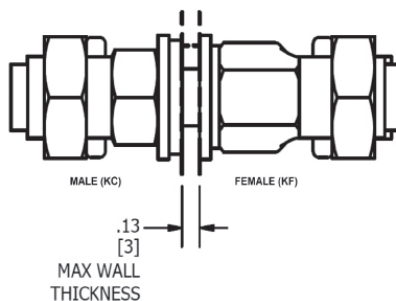
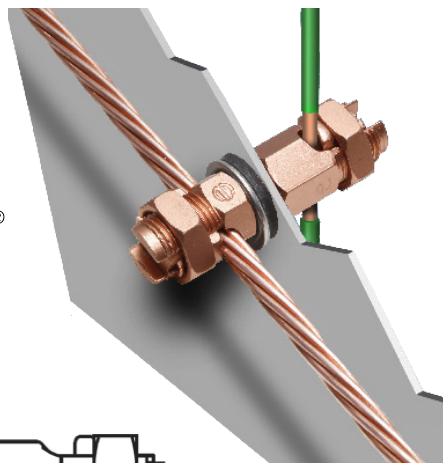

	Qty	Description
1	1	Male Servit Post
2	1	Stainless Steel Split Lock Washer*
3	2	Stainless Steel Flat Washer*
4	1	Sealing Washer*
5	1	Female SERVID®

*One flat washer and sealing washer to be installed on outside of box or, where applicable, to side of wall exposed to atmospheric or contaminated conditions. Remaining hardware to be mounted to opposite side of the wall as shown.

Catalog Number	ACCOMMODATES			NUT TORQUE IN-LBS [N-M]	MAX. THRU HOLE
	AWG		METRIC		
	STRANDED	SOLID	STRANDED		
KCKF23	#8 (.146) - #2 (.292)	#10 (.102) - #1 (.289)	10mm ² (4.1) - 35mm ² (6.5)	275 [31.1]	7/16
KCKF25	#2 (.292) - 1/0 (.373)	#2 (.258) - 2/0 (.365)	35mm ² (6.5) - 50mm ² (9.3)	385 [43.5]	9/16
KCKF28	#1 (.332) - 4/0 (.528)	#1 (.289) - 4/0 (.460)	50mm ² (9.3) - 95mm ² (12.8)	500 [56.5]	11/16

Notes:

- Dimensions in () are cable diameters.
- Diameters of AWG wires are in inches.
- Diameters for metric wires are given in mm.

Types KC-J12, EQC632C1 Transformer Ground Connectors for Copper

Equipment grounding connection point that installs within an equipment ground nut. Fits all standard EEI-NEMA distribution transformers as tank grounding terminal.



EQC632C1

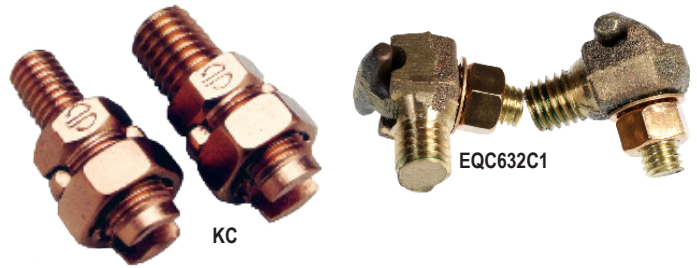

Catalog Number	Ranges	Stud Size
KC22J12T13	8 Sol. - 2 Sol.	1/2"-13
KC26	2 Sol. - 2/0 Str.	1/2"-13
KC34J12T13	3/0 - 500 Str.	1/2"-13
EQC632C1	8 Sol. - 2 Str.	1/2"-13

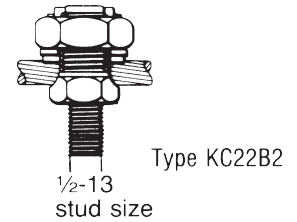

Type KS SERVIT® Split Bolt Connector for Copper

Compact, high strength, high copper alloy SERVIT® split bolt has free-running threads and easy to grip wrench flats. Highly resistant to season cracking and corrosion, the SERVIT® connectors provide maximum pressure and assure a secure connection on all combinations of run and tap conductors.

- Rated for Direct Burial in earth or concrete
- UL467 Listed

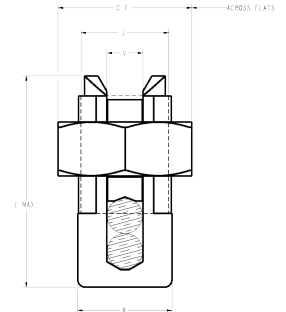
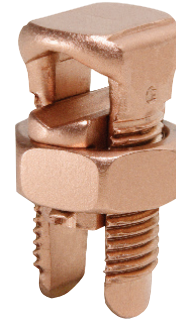
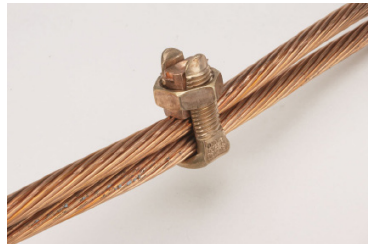

Catalog Number	Cross Flats	L	W	Copper Conductor Range	Rebar with (1) #8 Sol. Cu	Recommended Tightening Torque (in-lb)
KS15	0.50	0.85	0.38	10 - 8 Str.	—	80
KS17	0.63	1.14	0.45	8 Str. - 6 Sol.	—	165
KS20	0.69	1.20	0.51	8 Str. - 4 Sol.	—	165
KS22	0.75	1.50	0.60	6 Str. - 2 Sol.	—	275
KS23	0.82	1.54	0.62	6 Str. - 2 Str.	—	275
KS25	0.94	1.77	0.73	4 Str. - 1/0 Str.	—	385
KS26	1.05	1.94	0.82	2 Str. - 2/0 Str.	#3 (3/8")	385
KS27	1.36	1.86	1.17	1 Str. - 3/0 Str.	—	500
KS29	1.36	2.07	1.17	1 Str. - 250	#4 (1/2")	650
KS31	1.70	2.51	1.41	1/0 Str. - 350	#5 (5/8")	650
KS34	1.82	2.79	1.48	2/0 Str. - 500	#6 (3/4")	825

Type GRC

High Strength Ground Rod Clamp for Copper Cable to Rod

High copper alloy ground connector for joining a range of cable to copper clad, galvanized steel, and stainless steel ground rods. Slips over end of rod, one-wrench installation. UL467 Listed for direct burial in earth and concrete.

- Rated for Direct Burial in earth or concrete
- UL467 Listed for the US and Canadian Markets

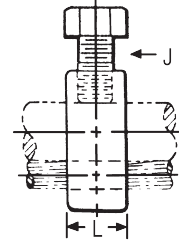
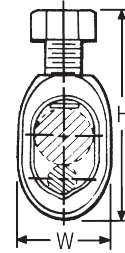

Catalog Number	Drive Rod	Conductor Range		H	W	L	J
		Min.	Max.				
GRC12	1/2	10 Sol.	2 Str.	2.00	0.89	0.63	3/8
GRC58	5/8	10 Sol.	1 Str.	2.19	0.95	0.63	3/8
GRC34	3/4	8 Sol.	1/0 Str.	2.47	1.09	0.65	3/8

Type GCRT1/0

Ground Clamp Range Taking up to 1/0

The GCRT1/0 is a range taking ground rod clamp offering another choice from the BURNDY® family of connectors. The GCRT1/0 works on 1/2", 5/8" and 3/4" ground rods, #4-#5 rebar with a wire range of #10 through 1/0. High copper alloy, stainless steel bolt.



Features & Benefits

- Range taking design helps reduce inventory needs
- Rated for Direct Burial in earth or concrete
- UL467 Listed for the US and Canadian Markets
- High copper alloy, stainless steel bolt

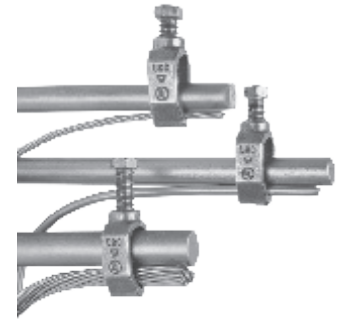

Catalog Number	Drive Rod	Rebar	Conductor Range	H	W	L	J
GCRT1/0	1/2, 5/8, 3/4	#4 - #5	#10 - 1/0	2.75	1.04	0.56	7/16

Type GRL

Light Duty Economical Ground Rod Clamp

UL467 Listed; Acceptable for direct burial in earth or concrete.



Catalog Number	Rod Size	Conductor Range	
		Minimum	Maximum
GRL3	3/8 in	10 AWG	4 AWG
GRL4	1/2 in	10 AWG	2 AWG
GRL5	5/8 in	10 AWG	2 AWG
GRL6	3/4 in	10 AWG	2 AWG

Type GKA Connector for Copper

Mechanical connector for grounding and bonding termination applications. One-piece body construction provides mechanical integrity in an underground environment. Supplied with stainless steel headless screw, the GKA25SB and GKA28SB have silicon bronze hardware.

- Rated for Direct Burial in earth or concrete
- UL467 Listed for the US and Canadian Markets

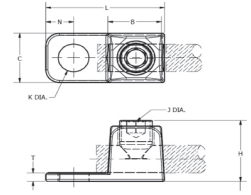
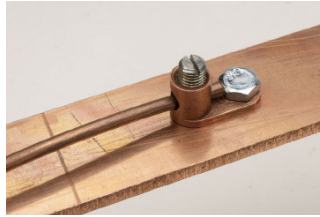

Catalog Number	Cable Range	B	C	H	J Dia.	K	L
GKA8C*	10 AWG-8 AWG	0.31	0.38	0.58	#12-24 (Slot)	0.21	0.81
GKA4C*	14 AWG-4 AWG	0.46	0.54	0.71	5/16-24 (Slot)	0.28	1.13
GKA25	4 AWG-1/0 AWG	0.69	0.75	0.94	1/2-20 (Hex)	0.42	1.69
GKA28	1 AWG-4/0 AWG	0.81	0.94	1.25	5/8-18 (Hex)	0.42	1.94
GKA25SB	4 AWG-1/0 AWG	0.69	0.75	0.94	1/2-20 (Hex)	0.42	1.69
GKA28SB	1 AWG-4/0 AWG	0.81	0.94	1.25	5/8-18 (Hex)	0.42	1.94

* GKA8C, GKA4C are cULus Listed.

Type KPB Connector for Copper

Mechanical connector for continuous run grounding and bonding applications. This exclusive BURNDY® design accommodates #10 - #4 copper where continuous conductor runs are preferable.

- Rated for Direct Burial in earth or concrete
- UL467 and UL486 Listed



Catalog Number	Copper Cable Range	Stud Hole
KPB4CG1 ^①	10 AWG-4 AWG	#10

① Can be assembled with optional TMH322SS stainless steel hardware kit, ordered separately.

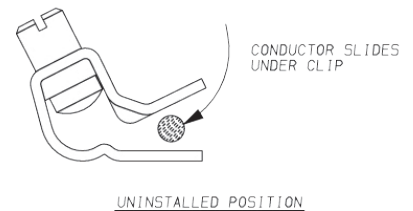
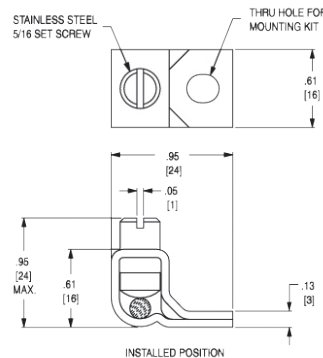

Types CL50-1, CL50-1TN Copper Lay-in QIKLUG™ for Copper

The Lay-In QIKLUG™ is manufactured from high strength pure electrolytic copper to ensure maximum strength and conductivity. The open-faced design allows for fast lay-in of the conductor without the need for cutting or breaking. Stainless steel screws used for excellent corrosion resistance.

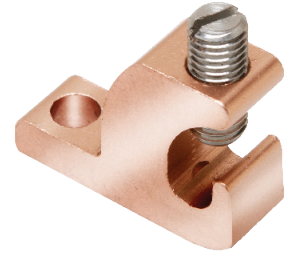

- Rated for Direct Burial in earth or concrete
- UL467 and UL2703* Listed for the US and Canadian Markets

Catalog Number	Conductor Range	Stud Hole	Recommended Torque by Wire Size	
CL50-1	14 AWG-4 AWG	#10		
CL50-1TN*	14 AWG-4 AWG	#10	14-10 AWG	20 in-lb
CL50-1TN BULK*	14 AWG-4 AWG	#10	8 AWG	25 in-lb
CL501TNMHWSST†	14 AWG-4 AWG	#10	6-4 AWG	35 in-lb
CL501TNMHWSST‡	14 AWG-4 AWG	#10		

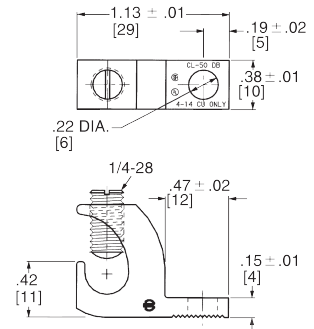

* CL501-TN & CL50-1TNBULK Listed to both UL2703 for Solar Applications and UL467 for direct burial.
 † Stainless Steel Mounting Hardware; Hex Head Self Tapping Screw and Washer
 ‡ Stainless Steel Mounting Hardware; Slotted Hex Head Machine Screw, Washer, Nut

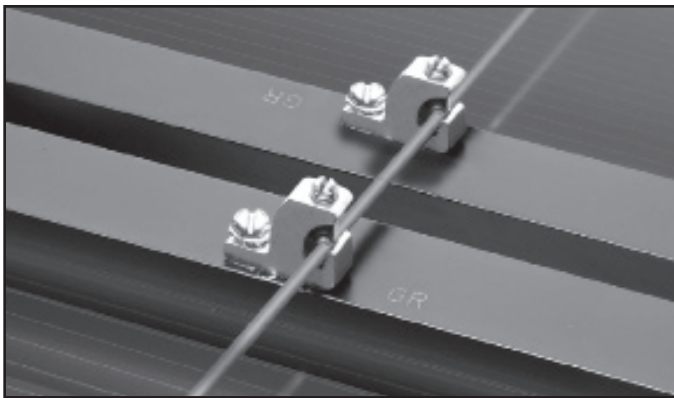

Photo above shows a typical solar panel installation using CL50-1TN connectors.



Type CL Copper Lay-in QIKLUG™ for Copper

Manufactured for maximum strength and conductivity, these lay-in lugs allow for continuous runs of conductor and are well suited as terminations as well. Tin-plated, set screw style connectors, three sizes cover a range from #14 AWG to 250 kcmil.

CL3/0-516TN and CL250-516TN are UL 486A-B Wire Connectors and CSA Certified. CL1/0-14TN UL Listed for grounding and CSA Certified. 90° C rated. Suitable for copper conductors only.

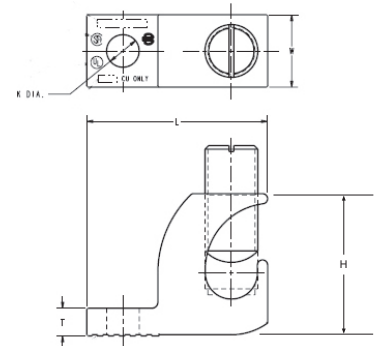
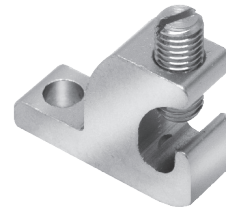

Catalog Number	Wire Range Copper	H	W	L	T	K Dia.	Hex Size
CL1/0-14TN	#14 - 1/0 AWG	1.17	0.60	1.50	0.22	0.27	7/16-20 (Slotted)
CL3/0-516TN	#6 - 3/0 AWG	1.56	0.80	2.00	0.30	0.33	9/16-18 (0.25 Hex)
CL250-516TN	#6 AWG - 250 kcmil	1.79	0.80	2.20	0.30	0.33	9/16-18 (0.25 Hex)

Type GCS-HEX; The CONSTRUCTOR® Ground Connector to Steel

The Type GCS-HEX series of connectors are used to ground cable to steel, I-beam, storage containers, or other flanged surfaces, in applications where drilling is either not possible or unwanted. Installation of the GCS-HEX type connectors requires no power tools and is suitable for applications where a removable connection is desired. The CONSTRUCTOR® GCS-HEX series of grounding connectors are UL Listed for Grounding and Bonding and Direct Burial Rated for installation in earth and concrete.

Features & Benefits

- ★ • Easy and simple hex tooling installation
- ★ • No hot work permit or drilling required
- Versatile; allows parallel or perpendicular conductor orientation
- Accepts beam thickness .125 - 1.000" (1/8 to 1")
- Conductor range from #6 AWG to 500 kcmil
- UL467 Listed
- Rated for Direct Burial in earth or concrete

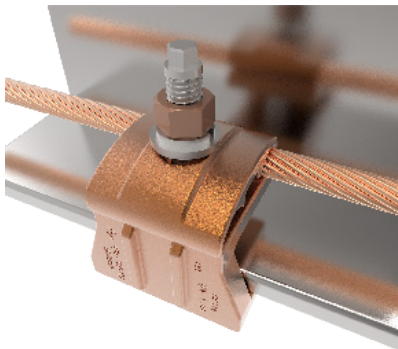
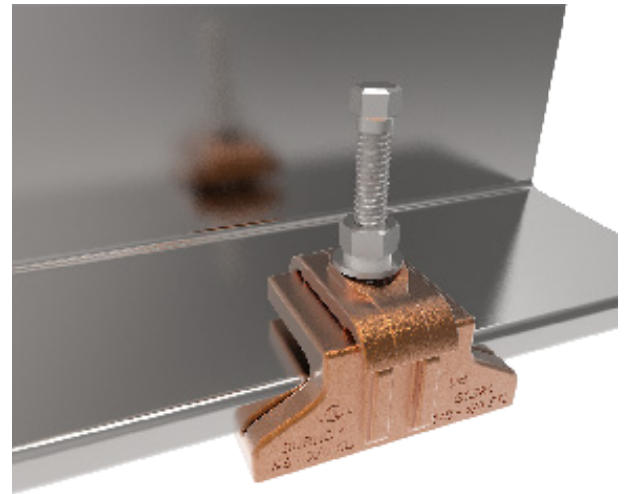

Parallel Configuration

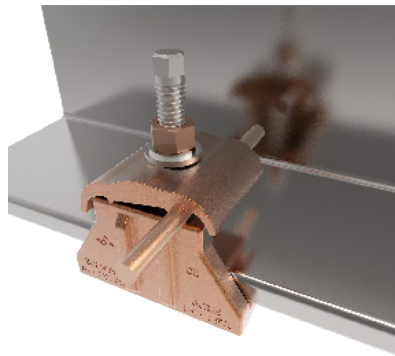

Perpendicular Configuration

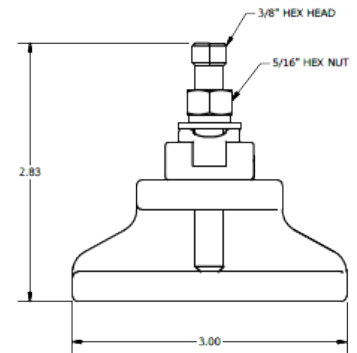

Line Art dimensions shown are GCS26HEX connector

Catalog Number	Accommodates		Installation Torque		Installation Tooling	
	Copper Conductor Size	Beam Thickness	Screw	Nut	Screw	Nut
GCS26HEX*	#6 - 2/0 AWG	1/8" to 5/8"	100 in-lb	180 in-lb	3/8"	1/2"
GCSL28HEX	#2 - 4/0 AWG	1/4" to 1"	180 in-lb	240 in-lb	3/8"	9/16"
GCS29HEX	#2 - 250 kcmil	1/4" to 1"	180 in-lb	240 in-lb	3/8"	9/16"
GCS34HEX	250 - 500 kcmil	1/2" to 1"	180 in-lb	480 in-lb	3/8"	3/4"

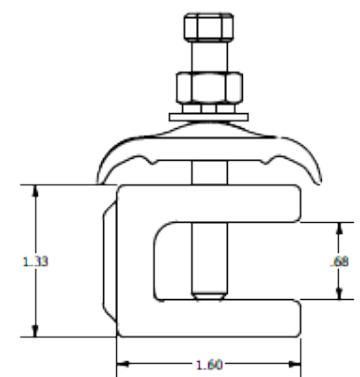

* GCS26HEX only cULus

Types GCSYA-WEEB, GCS2YA Tower Ground Clamps

The GCSYA-WEEB and GCS2YA series of connectors are used to terminate the equipment grounding conductor (EGC) to the tower structure, in applications where drilling or hot work permits are either not possible or unwanted. Installation requires no power tools and is simple to install. The GCSYA-WEEB single hole version is assembled with a WEEB® Washer to reduce one-hole lug rotation. These connectors can also be used in a variety of other applications as it is suitable to bond steel from 1/8" - 5/8" thick.

Features & Benefits

- Provides proper grounding of towers
- Easy and simple hex tooling installation
- No hot work permit or drilling required
- Includes compression lug and anti-rotation WEEB® Washer for one-hole applications
- Accommodates steel 1/8" to 5/8" thick
- Conductor range from #8 AWG to #2 AWG
- UL467 Listed
- AT&T Approved



Type
GCSYA-WEEB

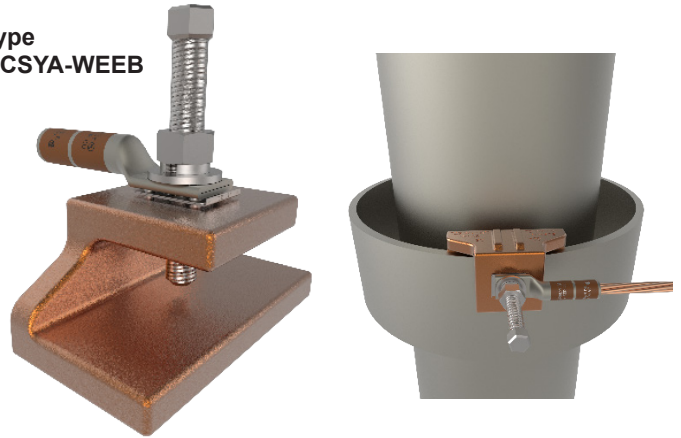

Type GCSYA-WEEB

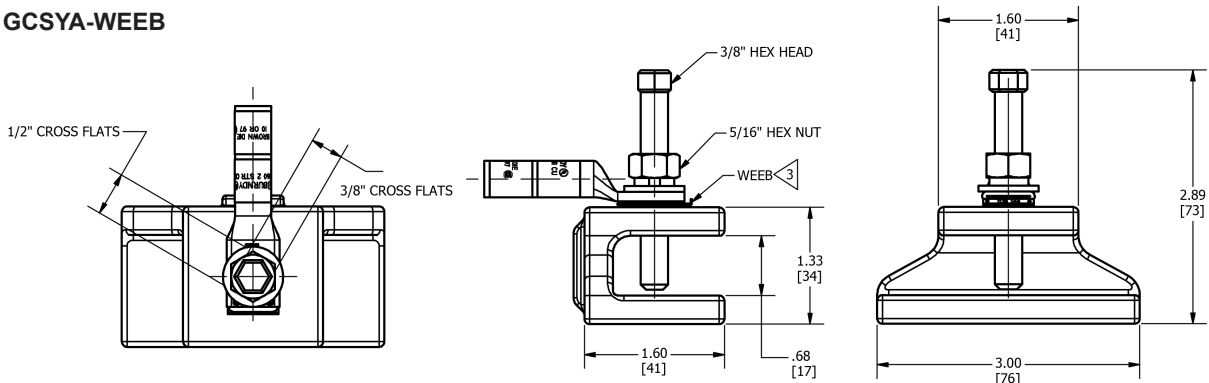

One-Hole Style includes WEEB® Washer

Catalog Number	Conductor	Flange Thickness	Recommended Torque (in-lb)		Compression Lug	Compression Lug Installation Tooling and Details
			Bolt	Nut		
GCSYA8CWEEB	#8 AWG	1/8" to 5/8"	100	180	YA8CTC38	See Sales Drawings or Section C (Compression) in the BURNDY Catalog
GCSYA6CWEEB	#6 AWG				YA6CTC38	
GCSYA4CWEEB	#4 AWG				YA4CTC38	
GCSYA3CWEEB	#3 AWG				YA3C	
GCSYA2CWEEB	#2 AWG				YA2C	
GCSYA1CWEEB	#1 AWG				YA1C	
GCSYA25WEEB	1/0 AWG				YA25	
GCSYA26WEEB	2/0 AWG				YA26TC516	

Types GCSYA-WEEB, GCS2YA (Continued)



Type GCS2YA



Type GCS2YA

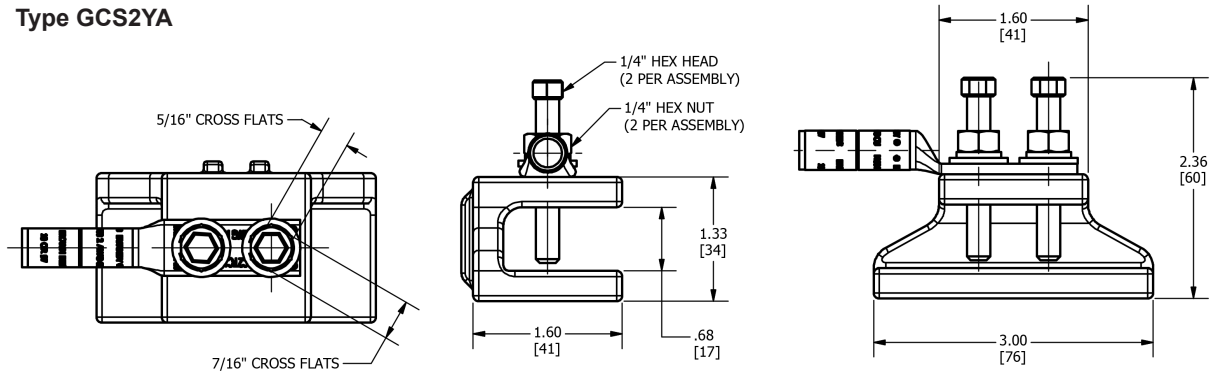

Two-Hole Style does not include WEEB® Washer

Catalog Number	Conductor	Flange Thickness	Recommended Torque (in-lb)		Compression Lug	Compression Lug Installation Tooling and Details
			Bolt	Nut		
GCS2YA8C	#8 AWG	1/8" to 5/8"	100	180	YA8C2TC14E2	See Sales Drawings or Section C (Compression) in the BURNDY Catalog
GCS2YA6C	#6 AWG				YA6C2TC14E2	
GCS2YA4C	#4 AWG				YA4C2TC14E2	
GCS2YA3C	#3 AWG				YA3C2TC14E2	
GCS2YA2C	#2 AWG				YA2C2TC14E2	
GCS2YA1C	#1 AWG				YA1C2TC14E2	
GCS2YA25	1/0 AWG				YA252TC14E2	
GCS2YA26	2/0 AWG				YA262TC14E2	

Mechanical Grounding

Parallel or 90° Copper Cable Connection to Rod or Pipe with Same Connector; Type GAR

Type GAR

For Parallel or 90° Copper Cable Connection to Rod or Pipe with the same connector

High copper alloy ground connector for joining a range of cable, parallel, or at right angles, to rod or tube. Especially good for fence posts. High copper alloy cast body with DURIUM™ Silicon Bronze U-bolts, nuts, and lockwashers, permit entire connection to be buried in earth or concrete without danger of corrosion.

Features & Benefits

- Wire to Rebar
- Fence Post Grounding Connector
- Wire to Pipe
- One-wrench installation
- Rated for Direct Burial in earth or concrete
- UL467 Listed for US and Canadian Markets
- Select connectors qualified to IEEE-837-2014

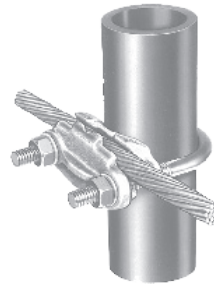
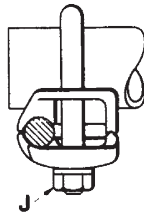
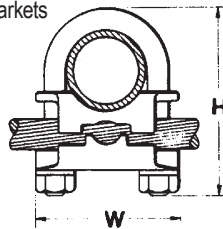

Wire at Right Angle to Pipe

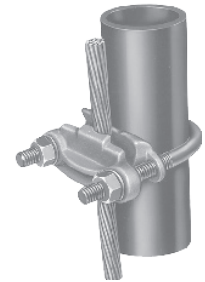

Wire Parallel to Pipe

Catalog Number	Conductor				H	J	W
	Tube I.P.S.*	Rod Size or O.D. Range	Rebar Size	Cable Range			
GAR114C	1/4	1/2	—	8 Sol. - 4 Str.	2-1/2	3/8	1-7/8
GAR1126	1/4	1/2	—	4 Sol. - 2/0 Str.	2-1/2	3/8	1-7/8
GAR1129	1/4	1/2	—	2/0 Sol. - 250	2-1/2	3/8	1-7/8
GAR644C	3/8	5/8 - 3/4	5 - 6	8 Sol. - 4 Str.	2-7/8	3/8	2-1/8
GAR6426	3/8	5/8 - 3/4	5 - 6	4 Sol. - 2/0 Str.	2-7/8	3/8	2-1/8
GAR6429	3/8	5/8 - 3/4	5 - 6	2/0 Sol. - 250	2-7/8	3/8	2-1/8
GAR6434	3/8	5/8 - 3/4	5 - 6	300-500	3-1/2	1/2	2-1/2
GAR144C	1/2-3/4	7/8 - 1	7 - 8	8 Sol. - 4 Str.	2-3/4	3/8	2-3/8
GAR1426	1/2-3/4	7/8 - 1	7 - 8	4 Sol. - 2/0 Str.	3	3/8	2-3/8
GAR1429	1/2-3/4	7/8 - 1	7 - 8	2/0 Sol. - 250	3	3/8	2-3/8
GAR1434	1/2-3/4	7/8 - 1	7 - 8	300-500	3-3/4	1/2	2-3/4
GAR154C	1	1-1/8 - 1-1/4	9 - 10	8 Sol. - 4 Str.	2-7/8	3/8	2-5/8
GAR1526	1	1-1/8 - 1-1/4	9 - 10	4 Sol. - 2/0 Str.	2-7/8	3/8	2-5/8
GAR1529	1	1-1/8 - 1-1/4	9 - 10	2/0 Sol. - 250	3-3/8	3/8	2-5/8
GAR1534	1	1-1/8 - 1-1/4	9 - 10	300-500	4-1/2	1/2	2-5/8
GAR164C	1-1/4	1-3/8 - 1-1/2	11	8 Sol. - 4 Str.	3-1/2	3/8	3
GAR1626	1-1/4	1-3/8 - 1-1/2	11	4 Sol. - 2/0 Str.	3-1/2	3/8	3
GAR1629	1-1/4	1-3/8 - 1-1/2	11	2/0 Sol. - 250	3-1/2	3/8	3
GAR1634	1-1/4	1-3/8 - 1-1/2	11	300-500	4-1/4	1/2	3-3/8

* This is the "Trade" Pipe Size reference.

Type GAR (Continued)



Catalog Number	Conductor				H	J	W
	Tube I.P.S.*	Rebar Size	Rod Size or O.D. Range	Cable Range			
GAR174C	1-1/2	—	1-5/8 - 1-7/8	8 Sol. - 4 Str.	4	3/8	3-1/4
GAR1726	1-1/2	—	1-5/8 - 1-7/8	4 Sol. - 2/0 Str.	4	3/8	3-1/4
GAR1729	1-1/2	—	1-5/8 - 1-7/8	2/0 Sol. - 250	4	3/8	3-1/4
GAR1734	1-1/2	—	1-5/8 - 1-7/8	300 - 500	4-5/8	1/2	2-5/8
GAR184C	2	—	2 - 2-3/8	8 Sol. - 4 Str.	4-1/4	3/8	3-3/4
GAR1826	2	—	2 - 2-3/8	4 Sol. - 2/0 Str.	4-1/4	3/8	3-3/4
GAR1829	2	—	2 - 2-3/8	2/0 Sol. - 250	4-1/2	3/8	3-3/4
GAR1834	2	—	2 - 2-3/8	300 - 500	5-1/4	1/2	4-1/8
GAR194C	2-1/2	—	2-1/2 - 2-7/8	8 Sol. - 4 Str.	5	3/8	4-1/4
GAR1926	2-1/2	—	2-1/2 - 2-7/8	4 Sol. - 2/0 Str.	5	3/8	4-1/4
GAR1929	2-1/2	—	2-1/2 - 2-7/8	2/0 Sol. - 250	5	3/8	4-1/4
GAR1934	2-1/2	—	2-1/2 - 2-7/8	300 - 500	5-5/8	1/2	4-5/8
GAR204C	3	—	3 - 3-1/2	8 Sol. - 4 Str.	5-5/8	3/8	4-3/4
GAR2026	3	—	3 - 3-1/2	4 Sol. - 2/0 Str.	5-5/8	3/8	4-3/4
GAR2029	3	—	3 - 3-1/2	2/0 Sol. - 250	5-5/8	3/8	4-3/4
GAR2034	3	—	3 - 3-1/2	300 - 500	6-3/8	1/2	5-1/4
GAR214C	3-1/2	—	3-1/2 - 4	8 Sol. - 4 Str.	6-1/4	3/8	5-3/8
GAR2126	3-1/2	—	3-1/2 - 4	4 Sol. - 2/0 Str.	6-1/4	3/8	5-3/8
GAR2129	3-1/2	—	3-1/2 - 4	2/0 Sol. - 250	6-1/4	3/8	5-3/8
GAR2134	3-1/2	—	3-1/2 - 4	300 - 500	6-3/4	1/2	5-3/4
GAR224C	4	—	4 - 4-1/2	8 Sol. - 4 Str.	6-3/8	3/8	5-7/8
GAR2226	4	—	4 - 4-1/2	4 Sol. - 2/0 Str.	6-3/8	3/8	5-7/8
GAR2229	4	—	4 - 4-1/2	2/0 Sol. - 250	6-3/8	3/8	5-7/8
GAR2234	4	—	4 - 4-1/2	300 - 500	6-7/8	1/2	6-1/4
GAR244C	5	—	—	8 Sol. - 4 Str.	7-3/4	3/8	6-7/8
GAR2426	5	—	—	4 Sol. - 2/0 Str.	7-3/4	3/8	6-7/8
GAR2429	5	—	—	2/0 Sol. - 250	7-3/4	3/8	7-1/4
GAR2434	5	—	—	300 - 500	8-5/8	1/2	7-1/4
GAR8629 ①	6	—	—	2/0 Sol. - 250	8-13/16	1/2	8-3/8
GAR8634	6	—	—	300 - 500	8-13/16	1/2	8-3/8

① Qualified to IEEE837-2014

* This is the "Trade" Pipe Size reference.

NOTE:

Contact BURNDY® for additional pipe and wire size combinations not shown.

Types GAR-BU, GAR3902 Ground Connectors

Type GAR-BU is a high-conductivity copper ground connector for connecting a small to medium range copper ground conductor to water pipe as well as structural and reinforcing rod shapes. Universal acceptance of several sizes of cylindrical shapes makes this suitable for industrial construction and maintenance work as well as cathodic protection. Cable clamp swivels to permit parallel grounding of one pipe or 90° degree cable run for grounding several parallel pipes. Single wrench installation. UL467 Listed and CSA Certified.

Features & Benefits

- Cable clamp swivels at 90°; permits parallel grounding of one pipe on a 90° cable run for grounding several parallel pipes
- One-wrench installation for simplified installation
- DURIMUM™ silicon bronze hardware (-BU Series)* provides long lasting corrosion resistance and acceptable for direct burial in earth of concrete
- Rated for Direct Burial in earth or concrete
- UL467 Listed for the US and Canadian Markets; provides quality assurance to recognized industry NEC standards from an independent party

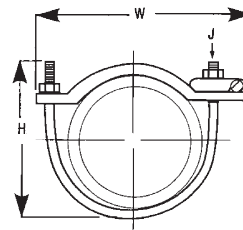

CLAMP SWIVELS 90°

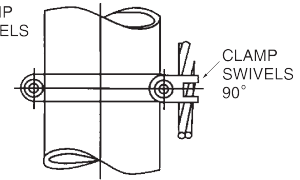

Catalog Number	Cable Range	IPS Size **	O.D. Range	H	J	W	Recommended Tightening Torque
GAR3902-BU ①	#4- 4/0 AWG	1/2-1	0.84 - 1.32	3.50	3/8" - 16	3.25	240 in. - lbs.
GAR3903-BU ①	#4- 4/0 AWG	1 1/4-2	1.66 - 2.38	4.00	3/8" - 16	4.25	240 in. - lbs.
GAR3904-BU ①	#4- 4/0 AWG	2 1/2-3 1/2	2.88 - 4.00	6.50	3/8" - 16	6.00	240 in. - lbs.
GAR3905-BU ①	#4- 4/0 AWG	4-5	4.50 - 5.56	7.50	3/8" - 16	7.50	240 in. - lbs.
GAR3906-BU ①	#4- 4/0 AWG	6	6.62	8.50	3/8" - 16	8.62	240 in. - lbs.
GAR3907-BU ①	#4- 4/0 AWG	8	8.62	10.00	3/8" - 16	10.62	240 in. - lbs.
GAR3908-BU ①	#4- 4/0 AWG	10	10.75	12.00	3/8" - 16	12.75	240 in. - lbs.
GAR3909-BU ①	#4- 4/0 AWG	12	12.75	14.00	3/8" - 16	14.75	240 in. - lbs.
GAR3902 ②	#4- 4/0 AWG	1/2-1	0.84 - 1.32	3.50	3/8" - 16	3.25	240 in. - lbs.
GAR3903 ②	#4- 4/0 AWG	1 1/4-2	1.66 - 2.38	4.00	3/8" - 16	4.25	240 in. - lbs.
GAR3904 ②	#4- 4/0 AWG	2 1/2-3 1/2	2.88 - 4.00	6.50	3/8" - 16	6.00	240 in. - lbs.
GAR3905 ②	#4- 4/0 AWG	4-5	4.50 - 5.56	7.50	3/8" - 16	7.50	240 in. - lbs.
GAR3906 ②	#4- 4/0 AWG	6	6.62	8.50	3/8" - 16	8.62	240 in. - lbs.
GAR3907 ②	#4- 4/0 AWG	8	8.62	10.00	3/8" - 16	10.62	240 in. - lbs.
GAR3908 ②	#4- 4/0 AWG	10	10.75	12.00	3/8" - 16	12.75	240 in. - lbs.
GAR3909 ②	#4- 4/0 AWG	12	12.75	14.00	3/8" - 16	14.75	240 in. - lbs.

① Type GAR-BU is supplied with DURIMUM™ silicon bronze hardware and is Listed for direct burial

② Standard Type GAR-3900 series supplied with galvanized U-bolt and hardware

** Refer to Section O for tube dimensions.

Type GAR-TC
Water Pipe Ground Connector

Type GAR-TC is a high-conductivity copper ground connector that features a pre-drilled pad, allowing a 2-hole compression terminal to be directly connected to water pipe as well as structural and reinforcing rod shapes. Universal acceptance of several sizes of cylindrical shapes makes this suitable for industrial construction and maintenance work as well as telecommunications grounding. Terminal may be mounted parallel, 45° or 90° degrees to the pipe. Acceptable for direct burial.

Features & Benefits

- Large, smooth connector contact area between pipe and ground clamp to maximize contact area between connector and pipe
- Type GAR-TC mounting pad permits parallel, 45°, or 90° angle connections to pipe for maximum flexibility for field installation
- Pre-drilled pad for (2) 3/8" bolts on 1" centers to allow for direct mounting of 2-hole compression terminals up to 750 kcmil to pipe
- DURIMUM™ silicon bronze hardware for long lasting corrosion resistance; acceptable for direct burial in earth or concrete
- One-wrench installation
- UL467 Listed for the US and Canadian Markets; provides quality assurance to recognized industry NEC standards from an independent party; Type GAR-TC is acceptable for Direct Burial in earth or concrete

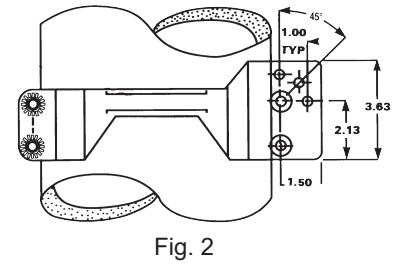
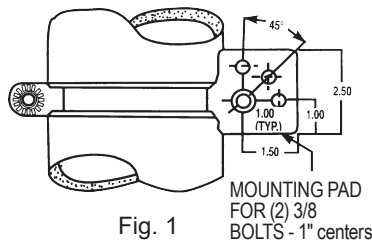
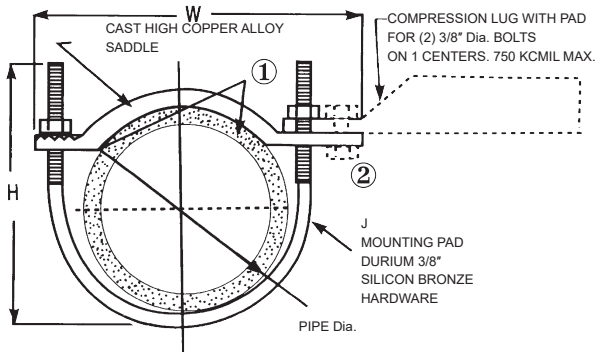
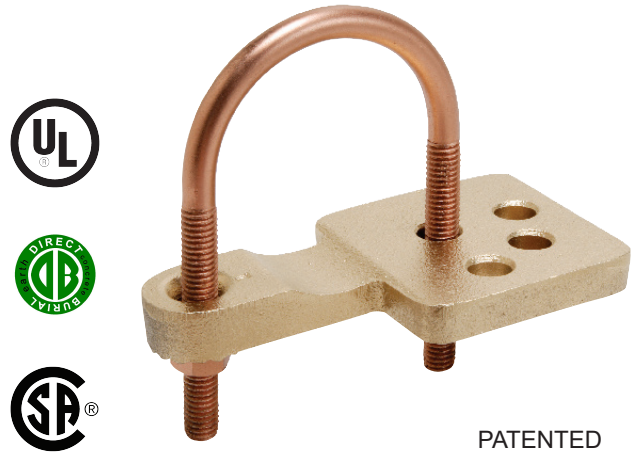

Catalog Number	Figure #	Accommodates		H	J	W	Recommended Torque
		I.P.S. **	O.D. Size				
GAR3902TC	1	1/2-1	0.84 - 1.32	3.50	3/8	3.75	240
GAR3903TC	1	1 1/4-2	1.66 - 2.38	4.00	3/8	4.75	240
GAR3904TC	1	2 1/2-3 1/2	2.88 - 4.00	6.50	3/8	6.50	240
GAR3905TC	1	4-5	4.50 - 5.56	7.50	3/8	8.00	240
GAR3906TC	1	6	6.62	8.50	3/8	9.12	240
GAR3907TC	2	8	8.62	10.00	3/8	11.25	240
GAR3908TC	2	10	10.75	12.00	3/8	13.25	240
GAR3909TC	2	12	12.75	14.00	3/8	15.25	240

NOTES:

** Refer to Section O for tube dimensions.

- ① Add suffix "-TNET" for electro-tin plated connector and electro-tin plated

DURIMUM™ silicon bronze hardware. Tin plated catalog number includes mounting hardware for second bolt hole.

② **OPTIONAL MOUNTING HARDWARE**

TMH-289 includes (1) 38X125HEB bolt, (1) 38CHEN nut, (1) 38SW split washer and (2) 38FW flat washers, ordered separately.

Clean pipe surface beneath saddle until virgin metal is exposed, install GAR-TC ground connector and for maximum conductivity, apply PENETROX™ E oxide inhibiting compound around perimeter of saddle.

Type GD

Two Copper Cables to Rod or Tube

High copper alloy ground connector for joining a range of two parallel cables to rod or pipe. Especially good for grounding fence posts. High copper alloy cast body with DURIMUM™ silicon bronze U-bolts, nuts, and lockwashers make the Type GD ground connectors are UL 467 Listed, suitable for direct burial in earth or concrete. One-wrench installation.

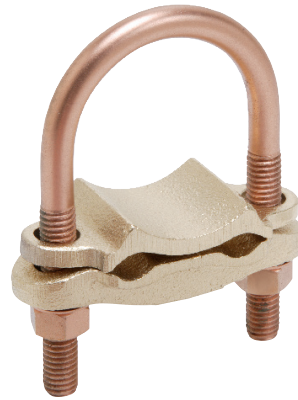

Features & Benefits

- Rated for Direct Burial in earth or concrete
- UL467 Listed for the US and Canadian Markets
- One-wrench installation

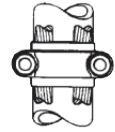
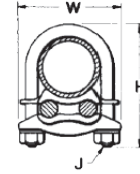

Catalog Number	Conductor			H	J	W
	Tube I.P.S. **	Rod Size or O.D. Range	Cable			
GD1526	1	1-1/8 - 1-1/4	4 Sol. - 2/0 Str.	3-3/8	3/8	2-5/8
GD1529	1	1-1/8 - 1-1/4	2/0 Sol. - 250	3-3/8	3/8	2-5/8
GD1626	1-1/4	1-3/8 - 1-1/2	4 Sol. - 2/0 Str.	3-1/2	3/8	3
GD1629	1-1/4	1-3/8 - 1-1/2	2/0 Sol. - 250	3-1/2	3/8	3-1/4
GD174C	1-1/2	1-5/8 - 1-7/8	8 Sol. - 4 Str.	4	3/8	3-1/4
GD1726	1-1/2	1-5/8 - 1-7/8	4 Sol. - 2/0 Str.	4	3/8	3-1/4
GD1729	1-1/2	1-5/8 - 1-7/8	2/0 Sol. - 250	4	3/8	3-1/4
GD1734	1-1/2	1-5/8 - 1-7/8	300 - 500	4-5/8	1/2	3-5/8
GD184C	2	2 - 2-3/8	8 Sol. - 4 Str.	4-3/8	3/8	3-3/4
GD1826	2	2 - 2-3/8	4 Sol. - 2/0 Str.	4-3/8	3/8	3-3/4
GD1829	2	2 - 2-3/8	2/0 Sol. - 250	4-3/8	3/8	3-3/4
GD1834	2	2 - 2-3/8	300 - 500	5-3/8	1/2	4-1/8
GD194C	2-1/2	2-1/2 - 2-7/8	8 Sol. - 4 Str.	5	3/8	4-1/4
GD1926	2-1/2	2-1/2 - 2-7/8	4 Sol. - 2/0 Str.	5	3/8	4-1/4
GD1929	2-1/2	2-1/2 - 2-7/8	2/0 Sol. - 250	5	3/8	4-1/4
GD1934	2-1/2	2-1/2 - 2-7/8	300 - 500	5	1/2	4-5/8
GD204C	3	3 - 3-1/2	8 Sol. - 4 Str.	5-5/8	3/8	4-7/8
GD2026	3	3 - 3-1/2	4 Sol. - 2/0 Str.	5-5/8	3/8	4-7/8
GD2029	3	3 - 3-1/2	2/0 Sol. - 250	5-5/8	3/8	4-7/8
GD2034	3	3 - 3-1/2	300 - 500	6-3/8	1/2	5-1/4
GD214C	3-1/2	3-1/2 - 4	8 Sol. - 4 Str.	6-1/4	3/8	5-3/8
GD2126	3-1/2	3-1/2 - 4	4 Sol. - 2/0 Str.	6-1/4	3/8	5-3/8
GD2129	3-1/2	3-1/2 - 4	2/0 Sol. - 250	6-1/4	3/8	5-3/8
GD2134	3-1/2	3-1/2 - 4	300 - 500	6-7/8	1/2	5-3/4
GD224C	4	4 - 4-1/2	8 Sol. - 4 Str.	6-3/8	3/8	5-7/8
GD2226	4	4 - 4-1/2	4 Sol. - 2/0 Str.	6-3/8	3/8	5-7/8
GD2229	4	4 - 4-1/2	2/0 Sol. - 250	6-3/8	3/8	5-7/8
GD2234	4	4 - 4-1/2	300 - 500	6-7/8	1/2	6-1/4

NOTE:

** Refer to Section O for tube dimensions.
Complies with NFPA 78-86 HEAVY DUTY stacks; use suffix "-LD"
for lead plating for HEAVY DUTY stack applications

Type GP

Two Copper Cables to Rod, Pipe or Column

High copper alloy ground connector for joining a range of two parallel cables perpendicular to rod, pipe or column. Also used with one groove for run, the other for tap to equipment. High copper alloy cast body and DURIMUM™ silicon bronze U-bolts, nuts, and lockwashers make Type GP connectors UL467 Listed and suitable for direct burial in the ground or concrete. One-wrench installation. UL467 Listed. Acceptable for direct burial in earth or concrete.



Features & Benefits

- Rated for Direct Burial in earth or concrete
- UL467 Listed for the US and Canadian Markets
- One-wrench installation

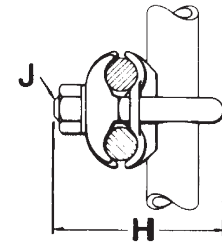
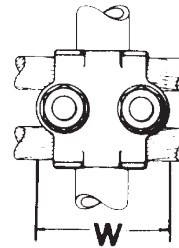

Catalog Number	Conductor			H	J	W
	Tube I.P.S. **	O.D. Size	Cable			
GP114C	1/4	1/2	8 Sol. - 4 Str.	2-1/2	3/8	1-7/8
GP1126	1/4	1/2	4 Sol. - 2/0 Str.	2-1/2	3/8	1-7/8
GP1129	1/4	1/2	2/0 Sol. - 250	2-1/2	3/8	1-7/8
GP644C	3/8	5/8 - 3/4	8 Sol. - 4 Str.	2-1/2	3/8	2-1/8
GP6426	3/8	5/8 - 3/4	4 Sol. - 2/0 Str.	2-1/2	3/8	2-1/8
GP6429	3/8	5/8 - 3/4	2/0 Sol. - 250	2-7/8	3/8	2-1/8
GP6434	3/8	5/8 - 3/4	300 - 500	3-1/2	1/2	2-5/9
GP144C	1/2-3/4	7/8 - 1	8 Sol. - 4 Str.	2-3/4	3/8	2-3/8
GP1426	1/2-3/4	7/8 - 1	4 Sol. - 2/0 Str.	3	3/8	2-3/8
GP1429	1/2-3/4	7/8 - 1	3/0 Sol. - 250	3	3/8	2-3/8
GP1434	1/2-3/4	7/8 - 1	300 - 500	3-3/4	1/2	2-5/8
GP154C	1	1-1/8 - 1-1/4	8 Sol. - 4 Str.	2-3/4	3/8	2-5/8
GP1526	1	1-1/8 - 1-1/4	4 Sol. - 2/0 Str.	3-1/4	3/8	2-5/8
GP164C	1-1/4	1-5/8	8 Sol. - 4 Str.	3-1/2	3/8	3
GP1629	1-1/4	1-5/8	2/0 Sol. - 250	3-1/2	3/8	3
GP1726	1-1/2	1-7/8	4 Sol. - 2/0 Str.	4	3/8	3-1/4
GP184C	2	2-3/8	8 Sol. - 4 Str.	4-1/8	3/8	3-11/16
GP1826	2	2-3/8	4 Sol. - 2/0 Str.	4-3/8	3/8	3-11/16
GP2026	3	3-1/2	4 Sol. - 2/0 Str.	5-1/2	3/8	4-13/16
GP2226	4	4-1/2	4 Sol. - 2/0 Str.	6-3/8	3/8	5-13/16

NOTE:

** Refer to Section O for tube dimensions.

Type GK

For Three Copper Cables to Rod or Pipe

High copper alloy ground connector for joining three equal cables to rod or tube. Cable grooves take a wide range of cable. High copper alloy cast body and DURIMUM™ silicon bronze U-bolts, nuts, and lockwashers make the GK suitable for direct burial in soil or concrete. One-wrench installation. UL467 Listed. Acceptable for direct burial in earth or concrete.

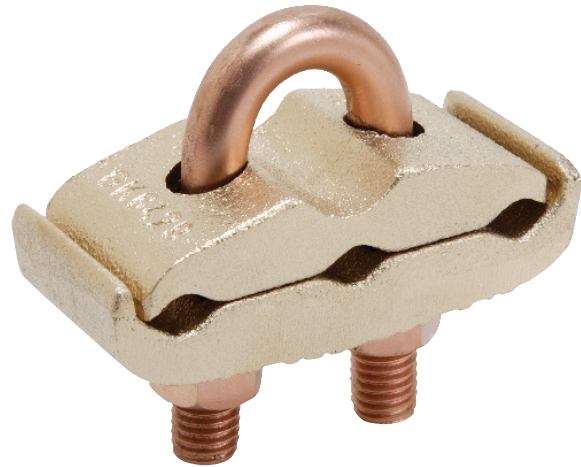

Features & Benefits



- Rated for Direct Burial in earth or concrete
- UL467 Listed for the US and Canadian Markets
- One-wrench installation

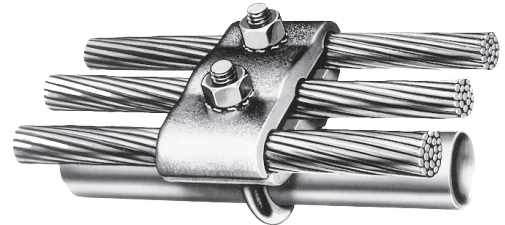
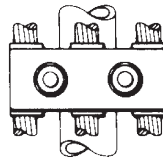
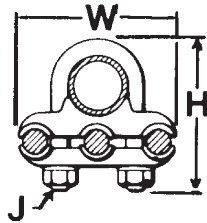

Catalog Number	Conductor			H	J	W
	Tube I.P.S. **	O.D. Size	Cable			
GK114C	1/4	1/2	8 Sol. - 4 Str.	2-1/2	3/8	2-1/2
GK1126	1/4	1/2	4 Sol. - 2/0 Str.	2-1/2	3/8	2-3/4
GK1129	1/4	1/2	2/0 Sol. - 250	2-1/2	1/2	3-3/8
GK644C	3/8	5/8 - 3/4	8 Sol. - 4 Str.	2-7/8	3/8	2-5/8
GK6426	3/8	5/8 - 3/4	4 Sol. - 2/0 Str.	2-7/8	3/8	3
GK6429	3/8	5/8 - 3/4	2/0 Sol. - 250	2-7/8	1/2	3-1/2
GK6434	3/8	5/8 - 3/4	300 - 500	3-1/2	1/2	4
GK1426	1/2 - 3/4	7/8 - 1	4 Sol. - 2/0 Str.	2-3/4	3/8	3-1/4
GK1429	1/2 - 3/4	7/8 - 1	2/0 Sol. - 250	3-3/4	1/2	3-7/8
GK1434	1/2 - 3/4	7/8 - 1	300 - 500	3-3/4	1/2	4-3/8
GK1526	1	1-1/8 - 1-1/4	4 Sol. - 2/0 Str.	3-3/8	3/8	3-1/2
GK1529	1	1-1/8 - 1-1/4	2/0 Sol. - 250	3-3/4	1/2	4-1/8
GK1626	1-1/4	1-3/8 - 1-1/2	4 Sol. - 2/0 Str.	3-1/2	3/8	3-7/8
GK1629	1-1/4	1-3/8 - 1-1/2	2/0 Sol. - 250	4-1/4	1/2	4-1/2
GK1726	1-1/2	1-5/8 - 1-7/8	4 Sol. - 2/0 Str.	4	3/8	4-1/8
GK1729	1-1/2	1-5/8 - 1-7/8	2/0 Sol. - 250	4-5/8	1/2	4-3/4
GK1826	2	2 - 2-3/8	4 Sol. - 2/0 Str.	4-1/4	3/8	4-5/8
GK1829	2	2 - 2-3/8	2/0 Sol. - 250	4-3/8	1/2	5-1/8
GK1926	2-1/2	2-1/2 - 2-7/8	4 Sol. - 2/0 Str.	5	3/8	5-1/8
GK1929	2-1/2	2-1/2 - 2-7/8	2/0 Sol. - 250	5	1/2	5-5/8

NOTE:

** Refer pages to Section-O for tube dimensions.

Type GG
For Copper Bar, Strap, Braid, or Cable to Rod or Tube

High copper alloy ground connector for joining bar, strap, braid or cable to rod or tube. High copper alloy cast body, DURILIUM™ silicon bronze U-bolts, nuts and lockwashers make the GG particularly effective for use with braid for ground rods, switch handles, fence posts and gates.

- Rated for Direct Burial in earth or concrete
- UL467 Listed
- One wrench installation

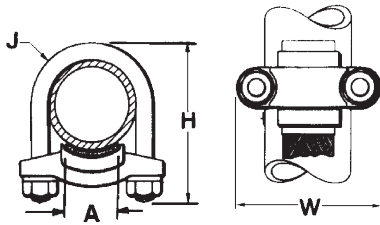
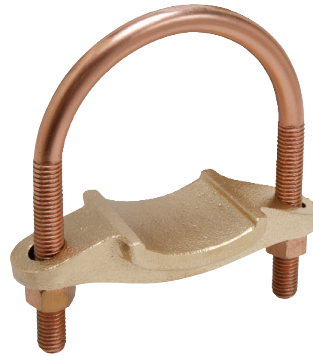

See our Braid offering also in this catalog section

Catalog Number	Conductor		A	H	J	W
	Tube I.P.S. **	Rod				
GG15-1	1	1-1/8 - 1-1/4	1	3-3/8	3/8	2-5/8
GG16-1	1-1/4	1-3/8 - 1-1/2		3		
GG17-1	1-1/2	1-5/8 - 1-7/8		3-1/2		3-1/4
GG17-15			1-1/2	3-3/4		
GG18-1	2	2 - 2-3/8	1	4-1/4	1/2	4-1/8
GG18-15			1-1/2	4-3/8		
GG18-2			2	5		
GG19-2	2-1/2	2-1/2 - 2-7/8	2-1/2	6-3/8	1/2	5-1/5
GG19-25			2-1/2			5-1/4
GG20-2	3	3 - 3-1/2	2	5-7/8	1/2	5-3/4
GG20-25			2-1/2			
GG20-3			3			
GG21-2	3-1/2	3-1/2 - 4	2	6-1/2	1/2	6-1/4
GG21-25			2-1/2			
GG21-3			3			
GG21-35			3-1/2			
GG22-2	4	4 - 4-1/2	2	7-5/8	1/2	7-1/4
GG22-25			2-1/2			
GG22-3			3			
GG22-4			4			
GG24-2	5	—	2	7-5/8	1/2	7-1/4

NOTE:

** Refer to Section O for tube dimensions.

Type FFG

Fence Fabric Ground Clamps

Fence grounding systems are designed to provide protection against dangerous “touch” potentials. The Fence Fabric Ground Clamp is an integral component of this personnel safety system.

With its unique design the clamp can form a connection at virtually any angle. Specific uses include connection to both fence fabric and barbed wire. The conductor maintains a path to ground while connected to an object that is parallel, perpendicular or any degree in between.

Tin plated copper clamp includes stainless steel hardware and allows for use on most metallic surfaces including galvanized steel. Other sizes available; please contact factory for information.



Features & Benefits

- Clamp can form connections at virtually any angle
- Tin plated copper clamp includes stainless steel hardware
- For use with most metallic surfaces including galvanized steel
- Conductor maintains path to ground while connected to object that is parallel, perpendicular, or any degree in between
- UL467 Listed for the US and Canadian Markets
- Select connectors qualified to IEEE-837-2014

Catalog Number	Conductor Size	Recommended Torque (in-lb)
FFGC8	#8	67
FFGC6	#6	67
FFGC4	#4	67
FFGC2 ①	#2	67
FFGC2/0	2/0	67

① Qualified to IEEE837-2014

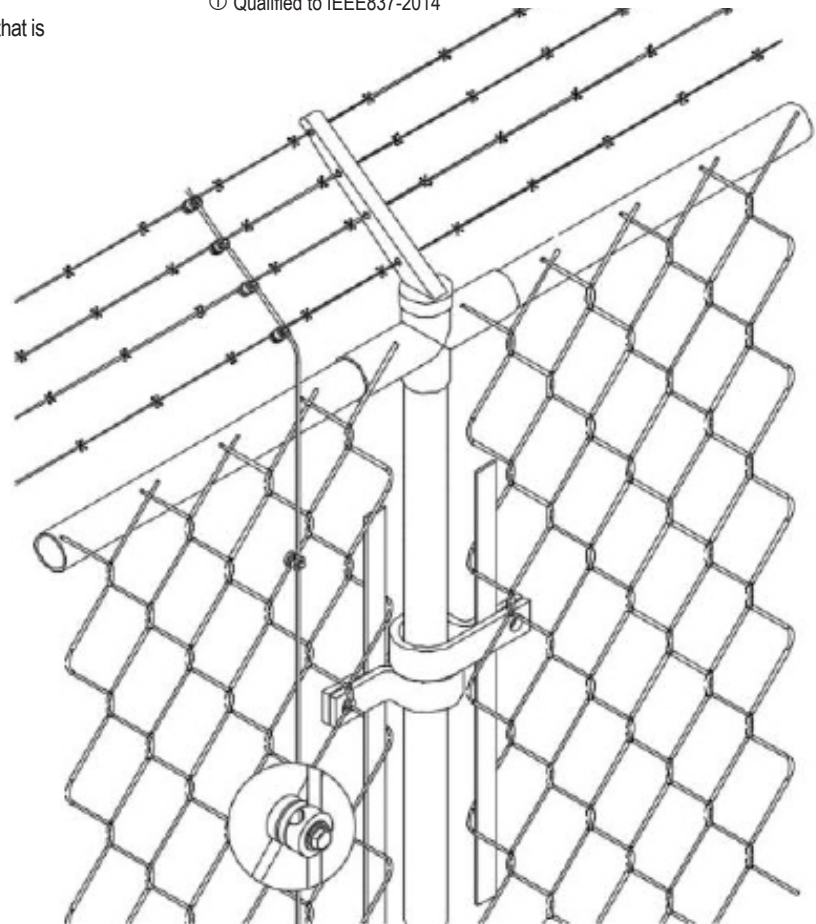
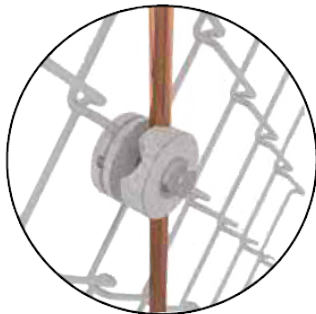

Type GA-H

For Copper Cable to "H" Beam or Square Fence Post

High copper alloy ground connector for joining a wide range of cable parallel to "H" beams or square tube. Hardware is made from DURIMUM™ silicon bronze for superior corrosion protection.

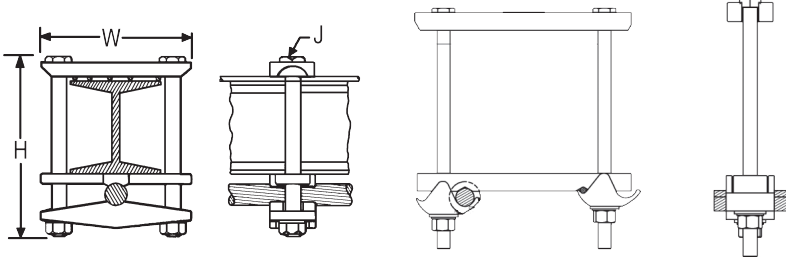

Figure 1

Figure 2

Catalog Number	Figure	Accommodates		H	J	W	Recommended Torque in-lb
		"H" Beam	Copper Conductor				
GA25H26	1	1-7/8" - 2-1/2" X 2-1/2"	4 Sol. - 2/0 Str.	4-3/4	3/8	4	240
GA25H29	1	1-7/8" - 2-1/2" X 2-1/2"	2/0 Sol. - 250 kcmil	4-3/4	3/8	4	240

NOTE: Contact factory for tin plated options

Catalog Number	Figure	Accommodates			H	J	W	Recommended Torque in-lb
		Square Fence Post	Copper Conductor					
			Small Clamp	Large Clamp				
GA400H294CTN	2	4"	6 Sol. (.162) - 4 Str. (.232)	1/0 Sol (.324) - 4/0 Str. (.528)	6.75 (171)	3/8	6.06 (154)	150

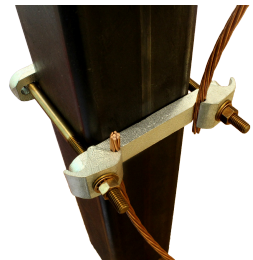

Type GA-H30SS

For Copper Cable to Square Fence Post

High copper alloy ground clamp for joining copper cable (#4 AWG - 300 kcmil) to square fence posts. Stainless steel hardware for superior corrosion resistance.

Features & Benefits

- Robust design for 6" and 8" square fence posts
- Tapered bolt design enhances connection to post
- Stainless steel hardware
- Rated for Direct Burial in earth or concrete
- UL467 Listed for the US and Canadian Markets

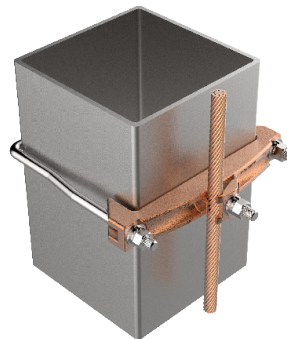

Catalog Number	Accommodates		H	Hardware size	W	Recommended Torque in-lb
	Square Fence Post	Copper Conductor				
GA600H30SS	6"	#4 AWG - 300 kcmil	9.38	1/2"	8.38	480 in-lb
GA800H30SS	8"	#4 AWG - 300 kcmil	11.38	1/2"	10.38	480 in-lb

Festoon Grounding Systems Kits

Includes C-Rail, Coupler Hangers, Tow and Intermediate Trolleys, End Stop, Mounting Clamps

Festoon Grounding Systems include the tracks, hardware, axles, and wheels needed to create a quality, "active" grounding system designed to stand the tests of time. Festoon systems elevate the conductor providing protection from pinch points as well as a theft deterrent.

BURNDY festoon systems are offered in a variety of lengths. Kits include the C-Rail, Coupler Hangers, Tow and Intermediate Trolleys, End Stop, and Mounting Clamps. Grounding cable and connectors are not included.

Features & Benefits

- Galvanized steel C-Rail for durability
- Sealed ball bearings in zinc-plated steel wheels are pre-lubricated for life offering consistent smooth operation
- Tow trolley protects conductor from pinch points
- Cable saddle helps keep conductor in line with track (ensure the cable size in use is accommodated by saddle)
- Festoon system keeps conductor elevated and out of easy reach from potential thieves

Specifications:

Wheels	Zinc-plated steel; smooth running ball bearing
Axles	Zinc-plated steel
C-Rail Track	Roll-formed galvanized steel
Hardware	Zinc-plated steel
Active Travel	Up to 25 ft (7.62m)*
Trolley Loads	Up to 45 lbs/trolley (20.25kg)**
Speed	Up to 250 fpm (75mpm)

*Additional kits are available for longer travel, contact customer service.

**Designed for cable loads only.

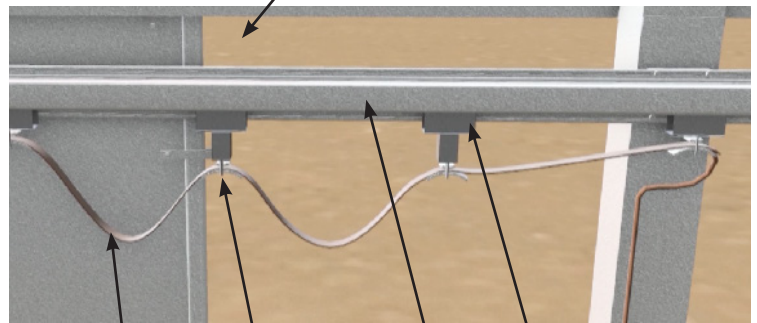
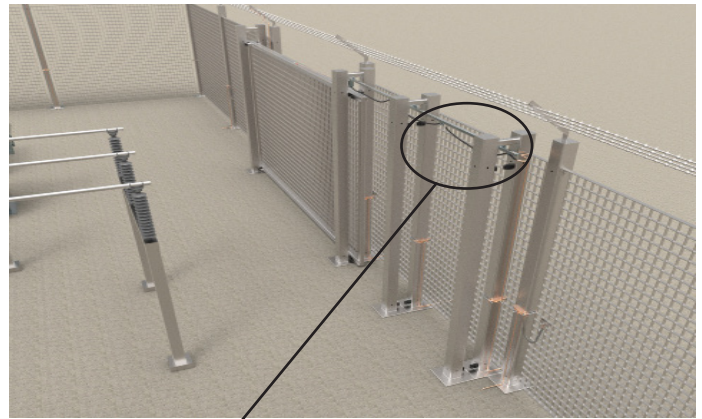

Cable (not included) Cable Saddle C-Rail Track Trolley

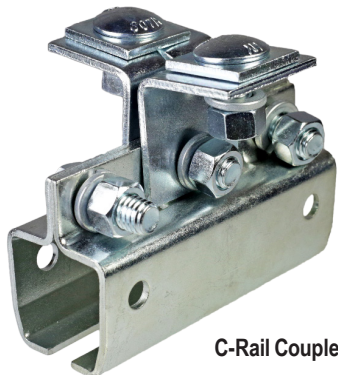

C-Rail Coupler

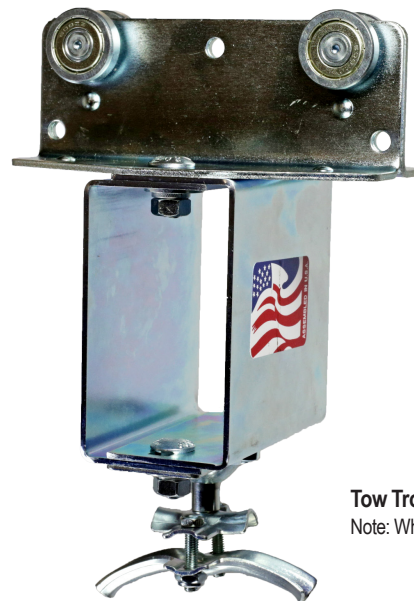

Tow Trolley Close-Up

Note: Wheels on trolleys fit inside C-Rail

Festoon Grounding System (Continued)

Catalog Number	Length				Trolley Count (Count only included intermediate trolleys)	Rails (Qty / Length)	Coupler Hanger (Qty)
	Active	Storage	System	Cable (not included)			
BCR02302	10'-10"	1'-4"	12'-8"	17'	2	2 / 6'	3
BCR03302	14'-6"	1'-7"	16'-7"	22'	3	3 / 6'	4
BCR04302	18'-2"	1'-11"	20'-6"	27'	4	4 / 6'	5
BCR05302	21'-9"	2'-2"	24'-4"	33'	5	5 / 6'	6
BCR06302	25'-5"	2'-5"	28'-3"	38'	6	5 / 6'	6
BCR07302	29'-0"	2'-8"	32'-2"	43'	7	6 / 6'	7
BCR10302	39'-11"	4'-6"	43'-11"	59'	10	10 / 6'	13

Terminology:

Active Length	maximum distance the first trolley moves from fully stored position to fully extended
System Length	equal to total rail length
Storage Length	minimum distance required to store trolleys when fully retracted (gate open)
Coupler	joins and aligns two sections of C-Rail together
End Stop	prevents trolley from over travelling in C-Rail track



Cable Saddle Close-Up

Note: When choosing your kit, ensure the cable size is accommodated by the saddle

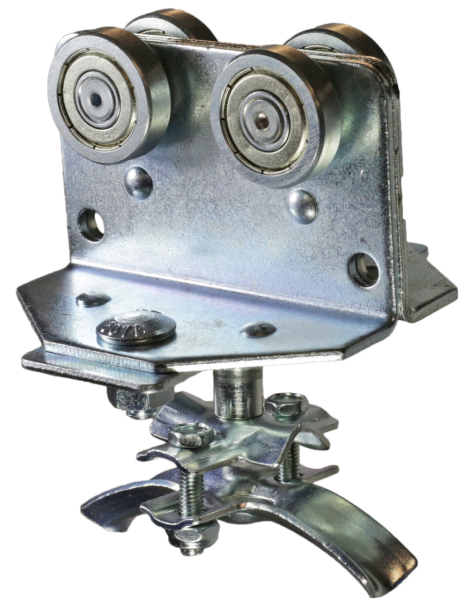

Intermediate Trolley Close-Up



Wheel Close-Up

Note: Sealed ball bearings are pre-lubricated for life for smooth operation and longevity

Type GQ

Ground Connector for Copper Cable to Tube

High copper alloy ground connector for cross connecting a wide range of cable. High copper alloy, cast body, DURIMUM™ U-bolts, nuts, and lockwashers make the GQ suitable for burial in earth or concrete.

- Rated for Direct Burial in earth or concrete
- UL467 Listed for the US and Canadian Markets
- One wrench installation

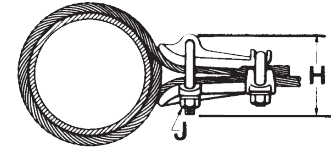
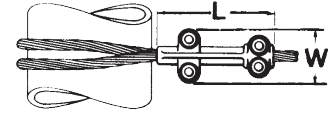
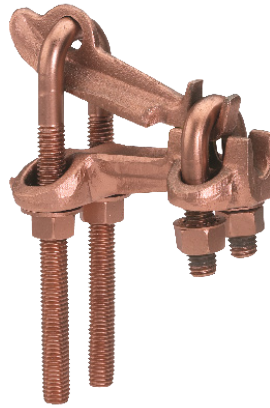

Catalog Number	Conductor		H	J	L	W
	I.P.S.	Cable				
GQ2626	6" Max.	4 Str. - 2/0 Str.	4-1/2	1/2	5	2-1/2
GQ26-1	Above 6"	4 Str. - 2/0 Str.	7-1/8	1/2	5	2-1/2
GQ2929	6" Max.	2/0 Str. - 250	4-1/8	1/2	6	2-3/4
GQ29-1	Above 6"	2/0 Str. - 250	7-1/2	1/2	6	2-3/4

Type GX

Ground Connector for Copper Cables

High copper alloy ground connector for cross connecting a wide range of cable. The high copper alloy cast body, DURIMUM™ U-bolts, nuts, and lockwashers make the GX suitable for burial in earth or concrete.

- Rated for Direct Burial in earth or concrete
- UL467 Listed
- One wrench installation

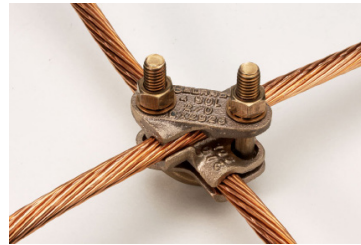
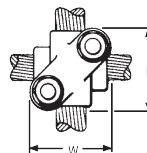
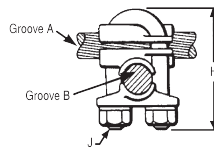

Catalog Number	Conductor		H	J	L	W
	Groove A	Groove B				
GX4C4C	8 Sol. - 4 Str.	8 Sol. - 4 Str.	1-7/8	3/8	1-5/8	1-5/8
GX264C	4 Sol. - 2/0 Str.	8 Sol. - 4 Str.	2-1/2	3/8	1-3/4	1-2/3
GX2626	4 Sol. - 2/0 Str.	4 Sol. - 2/0 Str.	2-1/2	3/8	1-3/4	1-2/3
GX294C	2/0 Sol. - 250	8 Sol. - 4 Str.	2-3/4	3/8	1-7/8	1-7/8
GX2926	2/0 Sol. - 250	4 Sol. - 2/0 Str.	2-1/2	3/8	1-7/8	1-7/8
GX2929	2/0 Sol. - 250	2/0 Sol. - 250	2-3/4	3/8	1-7/8	1-7/8
GX344C	300 - 500	8 Sol. - 4 Str.	2-3/4	3/8	2-1/8	1-7/8
GX3426	300 - 500	4 Sol. - 2/0 Str.	2-3/4	3/8	2-1/8	1-7/8
GX3429	300 - 500	2/0 Sol. - 250	2-3/4	3/8	2-1/8	1-7/8
GX3434	300 - 500	300 - 500	4-1/4	1/2	2-5/8	2-5/8

CPI™ Ground Grid Connectors

Accommodates .679" - .813" Diameter Range (Vertical)

.368" - .813" Diameter Range (Horizontal)

CPI Ground Grid Connectors are a safe, fast, and dependable method of making permanent wire-to-wire and wire-to-rod connections for a variety of grounding applications. Using a special shear-head bolt to drive a wedge into the connector activates the connector. When the proper torque and spring tension is achieved, the bolt head shears off, giving the installer a positive indication of an optimum connection.

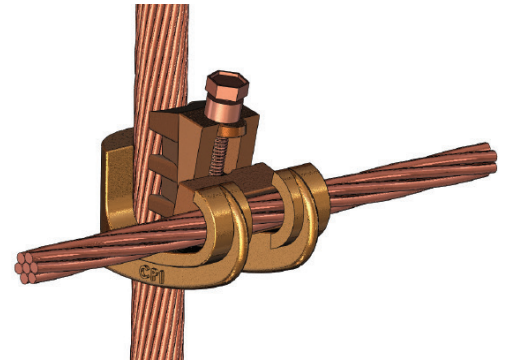

Features and Benefits

- No special molds, chemicals, tools, dies or fired-on charges necessary for installation; installed with a common socket, impact or ratchet wrench
- No temperature or weather restrictions for installation; can be installed no matter what environment exists at the job site
- Shear-head bolt ensures consistency of application and positive verification of a completed connection
- Typical applications:
 - Substation ground grids
 - Pole grounds transmission line grounding
 - Industrial/Residential service grounds
 - Pad Mount Transformers
 - Telco distribution / CATV grounds
 - Wind Farms

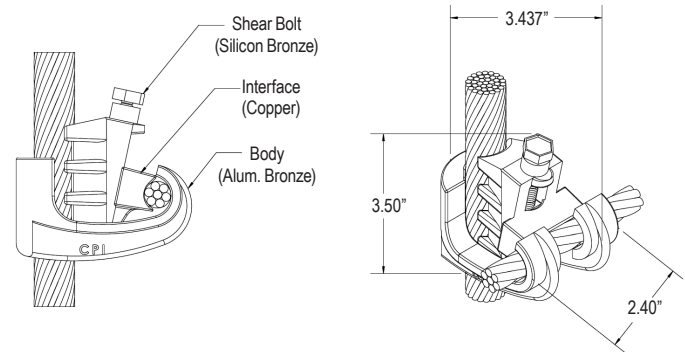

Catalog Number	Conductor			
	Vertical	Vertical Dia. Range	Horizontal	Horizontal Dia. Range
900200	500 kcmil, 450 kcmil	.813", .769"	500 kcmil, 450 kcmil	.813", .769"
	500 kcmil	.813"	400 kcmil	.726"
900201	500 kcmil, 450 kcmil	.813", .769"	350 kcmil, 300 kcmil, 3/4 Rod	.679", .629", .680"
	450 kcmil, 400 kcmil	.769", .726"	400 kcmil	.726"
900202	500 kcmil, 450 kcmil	.813", .769"	250 kcmil, 5/8" Rod, 4/0 Str	.574", .556", .522"
	350 kcmil	.679"	350 kcmil, 300 kcmil, 3/4 Rod	.679", .629", .680"
	400 kcmil	.726"	250 kcmil, 5/8" Rod	.574", .556"
900203	500 kcmil, 450 kcmil	.813", .769"	1/0 Str, 2/0 Str	.368", .419"

CPI™ Ground Grid Connectors

Accommodates .679" - .813" Diameter Range (Vertical)

.368" - .813" Diameter Range (Horizontal)

CPI Ground Grid Connectors are a safe, fast, and dependable method of making permanent wire-to-wire and wire-to-rod connections for a variety of grounding applications. Using a special shear-head bolt to drive a wedge into the connector activates the connector. When the proper torque and spring tension is achieved, the bolt head shears off, giving the installer a positive indication of an optimum connection.

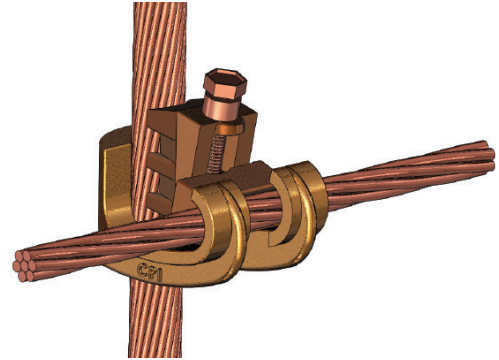

Features and Benefits

- No special molds, chemicals, tools, dies or fired-on charges necessary for installation; installed with a common socket, impact or ratchet wrench
- No temperature or weather restrictions for installation; can be installed no matter what environment exists at the job site
- Shear-head bolt ensures consistency of application and positive verification of a completed connection
- Typical applications:
 - Substation ground grids
 - Pole grounds transmission line grounding
 - Industrial/Residential service grounds
 - Pad Mount Transformers
 - Telco distribution / CATV grounds
 - Wind Farms

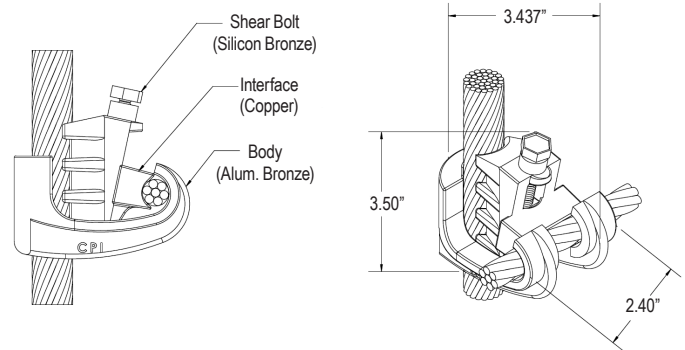

Catalog Number	Conductor			
	Vertical	Vertical Dia. Range	Horizontal	Horizontal Dia. Range
900200	500 kcmil, 450 kcmil	.813", .769"	500 kcmil, 450 kcmil	.813", .769"
	500 kcmil	.813"	400 kcmil	.726"
900201	500 kcmil, 450 kcmil	.813", .769"	350 kcmil, 300 kcmil, 3/4 Rod	.679", .629", .680"
	450 kcmil, 400 kcmil	.769", .726"	400 kcmil	.726"
900202	500 kcmil, 450 kcmil	.813", .769"	250 kcmil, 5/8" Rod, 4/0 Str	.574", .556", .522"
	350 kcmil	.679"	350 kcmil, 300 kcmil, 3/4 Rod	.679", .629", .680"
	400 kcmil	.726"	250 kcmil, 5/8" Rod	.574", .556"
900203	500 kcmil, 450 kcmil	.813", .769"	1/0 Str, 2/0 Str	.368", .419"

Type C-JPT
Cast Bronze Clamps for Conduit

Pressure bar type conduit hub adjusts for 1/2", 3/4" EMT, or 1/2" rigid conduit. Hub swings 360° for easy alignment. Supplied with Zinc plated hardware.

- UL467 Listed for the US and Canadian Markets



Catalog Number	Accommodates Conductor Range			Reference Dimensions			Recommended Screw Torque (Inch Pounds)	
	Water Pipe	Ground	Hub Size	H	L	W	Pipe Clamp	Wire Clamp
C-11JPT	1/2 - 1 [13 - 25]	10 - 6 Sol.	1/2 [13]	2.07 in [53]	3.19 [81]	2.70 in [69]	50 in.-lb.	50 in.-lb.
C-22JPT	1-1/4 - 2 [32 - 51]	10 - 6 Sol.	1/2 [13]	2.70 in [69]	3.83 [97]	2.70 in [69]	50 in.-lb.	50 in.-lb.
C-4JPT	2-1/2 - 4 [64 - 102]	10 - 6 Sol.	1/2 [13]	4.39 in [112]	5.15 [131]	2.70 in [69]	50 in.-lb.	50 in.-lb.

Type C-; Cast Bronze Clamps
for Ground Conductor to Water Pipe or Copper Tube

For connecting grounding conductor to water pipe or copper tube. "D" indicates UL467 Listed for direct burial in earth and concrete and are supplied with silicon bronze hardware. "B" indicates brass hardware.

- Rated for Direct Burial in earth or concrete
- UL467 Listed for the US and Canadian Markets



Catalog Number	Accommodates Conductor Range			Reference Dimensions				Recommended Screw Torque (Inch Pounds)	
	Water Pipe	Rebar	Ground	H	L	W	C	Pipe Clamp	Wire Clamp
C-11N	1/2 - 1 [13 - 25]	—	10 - 2 Str.	1.81 in [46]	2.25 [56]	0.63 in [16]	0.63 in [16]	50 in.-lb.	50 in.-lb.
C-11D†	1/2 - 1 [13 - 25]	#4 - #8	10 - 2 Str.	1.81 in [46]	2.25 [56]	0.63 in [16]	0.63 in [16]	50 in.-lb.	50 in.-lb.
C-11B	1/2 - 1 [13 - 25]	—	10 - 2 Str.	1.81 in [46]	2.25 [56]	0.63 in [16]	0.63 in [16]	50 in.-lb.	50 in.-lb.
C-22*	1-1/4 - 2 [32 - 51]	—	10 - 2 Str.	2.38 in [60]	3.63 [92]	0.75 in [0.19]	1.00 in [25]	50 in.-lb.	50 in.-lb.
C-22D†	1-1/4 - 2 [32 - 51]	—	10 - 2 Str.	2.38 in [60]	3.63 [92]	0.75 in [0.19]	1.00 in [25]	50 in.-lb.	50 in.-lb.
C-4*	2-1/2 - 4 [46 - 114]	—	10 - 2 Str.	4.13 in [105]	6.25 [159]	0.96 in [24]	1.88 in [48]	50 in.-lb.	50 in.-lb.
C-4D†	2-1/2 - 4 [46 - 114]	—	10 - 2 Str.	4.13 in [105]	6.25 [159]	0.96 in [24]	1.88 in [48]	50 in.-lb.	50 in.-lb.
C-8*	4-1/2 - 6 [114 - 165]	—	10 - 2 Str.	4.29 in [109]	8.34 [212]	1.25 in [32]	1.88 in [48]	50 in.-lb.	50 in.-lb.

* Supplied with zinc-plated steel hardware.

† Add -TN for Tin Plated connector.

Mechanical Grounding

Cast Bronze Ground Clamps; for Water Pipe (Type C5) with Lay-In Feature (Type C-K-D); Die Cast Clamps (Type CZ)

Type C5; Light Duty Cast Bronze Clamps for 1/2" - 1" Water Pipe



Similar to C-11 clamp but for lighter duty applications.

- UL467 Listed for the US and Canadian Markets

Catalog Number	Accommodates Conductor Range		Reference Dimensions			Recommended Screw Torque (Inch Pounds)	
	Water Pipe	Ground	H	L	W	Pipe Clamp	Wire Clamp
C-5	1/2" - 1" [13 -25]	10 - 2 Str.	1.56 in [40]	2.25 [56]	0.56 in [14]	50 in.-lb.	50 in.-lb.

Type C-K-D Cast Bronze Clamps with Lay-In Feature

For connecting grounding conductor to water pipe, copper tube, ground rod or rebar. The open face design allows for fast lay-in of the tap conductor without the need for cutting. Simply reverse bottom clamp for smaller size rebar or rod. Connectors are provided with Silicon Bronze hardware.

- Rated for Direct Burial in earth or concrete
- UL467 Listed for the US and Canadian Markets



Fig. 1



Fig. 2

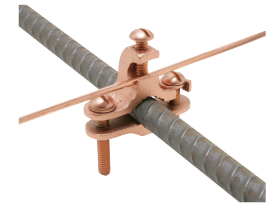
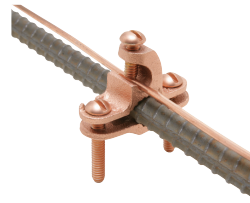

Catalog Number	Fig. #	Accommodates Conductor Range				Reference Dimensions			Recommended Screw Torque (Inch Pounds)
		Main			Tap	H	L	W	
		Water Pipe	Rebar	Ground Rod	Ground				
C11K16D	1	1/2" - 1" [13-25]	#4 - #6	3/8" - 1"	#10 - #2 Str.	1.64	2.28	0.66	50 in.-lbs.
C11K17D	2	1/2" - 1" [13-25]	#4 - #6	3/8" - 1"	#10 - #2 Str.	1.64	2.28	0.66	50 in.-lbs.

Type CZ Die Cast Clamps



Die cast zinc with zinc-plated screws.

- UL467 Listed for the US and Canadian Markets



Catalog Number	Accommodates Conductor Range		Reference Dimensions				Recommended Screw Torque (Inch Pounds)	
	Water Pipe	Ground	H	L	W	C	Pipe Clamp	Wire Clamp
CZ-11	1/2" - 1" [13-25]	10 - 2 Str.	1.56" [40]	2.25" [56]	0.56" [14]	0.50" [13]	50 in.-lb.	50 in.-lb.

Type C-JA

Cast Bronze Clamps for Armored Cable to Water Pipe

To connect armored cable to water pipe. Zinc plated screws. Pressure bar grips armor or outer cable insulation. 360° swing hub for easy alignment.

- UL467 Listed for the US and Canadian Markets

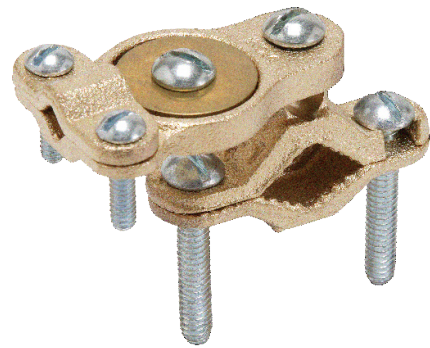

Catalog Number	Accommodates Conductor Range		Reference Dimensions			Recommended Torque	
	Water Pipe	Armored Conductor	H	L	W	Pipe Clamp	Wire Clamp
C-11JA	1/2 - 1 [13-25]	10 - 6 Sol.	1.38" [35]	3.05" [77]	1.41" [36]	50 in.-lb.	50 in.-lb.
C-22JA	1-1/4 - 2 [32-51]	10 - 6 Sol.	2.60" [66]	3.69" [94]	1.41" [36]	50 in.-lb.	50 in.-lb.
C-4JA	2-1/2 - 4 [64-102]	10 - 6 Sol.	4.29" [109]	5.01" [128]	1.41" [36]	50 in.-lb.	50 in.-lb.

Type C-HD-DB

Cast Bronze Clamps for Grounding Conductor, EMT, or Rigid Conduit to Water Pipe/Copper Tube/Ground Rod/Rebar

For connecting grounding conductor, EMT or rigid conduit to water pipe, copper tube, ground rod or rebar. Hub swings 360° for easy alignment. Simply reverse bottom clamp for smaller size rebar or rod. Connectors are provided with Silicon Bronze hardware.

- Rated for Direct Burial in earth or concrete
- UL467 Listed for the US and Canadian Markets

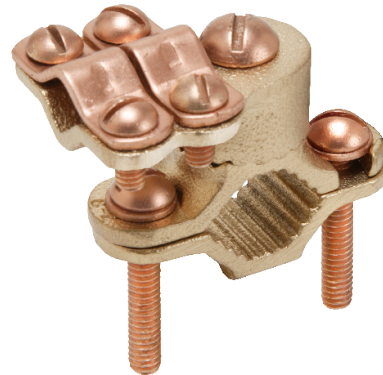

Catalog Number	Accommodates Conductor Range				Reference Dimensions			Recommended Screw Torque (Inch Pounds)
	Main			Tap	H	L	W	
	Water Pipe	Rebar	Ground Rod	Ground				
C11HD4/0DB	1/2" - 1" [13-25]	#4 - #6	3/8" - 1"	#8 - 4/0 AWG	2.25	2.65	1.56	50 in.-lbs.
C22HD4/0DB	1-1/4" - 2" [32-51]	—	—	#8 - 4/0 AWG	2.70	3.60	1.56	50 in.-lbs.

Type C- Cast Bronze Clamps

For connecting armored cable to water pipe. Zinc plated screws. "D" indicates UL467 for direct burial in earth and concrete, supplied with silicon bronze hardware.

- Rated for Direct Burial in earth or concrete
- UL467 Listed for the US and Candian Markets



C-6 Shown

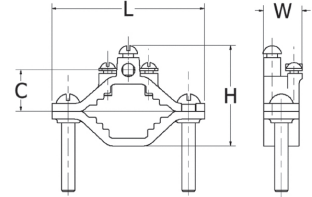

Catalog Number	Accommodates Conductor Range			Reference Dimensions				Recommended Screw Torque (Inch Pounds)	
	Water Pipe	Ground	Ground Clamp	H	L	W	C	Pipe Clamp	Wire Clamp
C-6	1/2 - 1 [13-25]	10 - 2 Str.	Bare Armored Unarmored Wire Cables or Cords	1.60" [41]	2.34" [59]	1.06" [27]	0.63" [16]	50 in.-lb.	50 in.-lb.
C-6D	1/2 - 1 [13-25]	10 - 2 Str.		1.60" [41]	2.34" [59]	1.06" [27]	0.63" [16]	50 in.-lb.	50 in.-lb.
C-7	1-1/4 - 2 [32-51]	10 - 2 Str.		2.38" [60]	3.62" [92]	0.94" [24]	1.00" [25]	50 in.-lb.	50 in.-lb.

Type C- Cast Bronze Clamps for Rigid Conduit

For grounding rigid conduit systems; supplied with zinc plated screws.

- UL467 Listed for the US and Candian Markets



C-61 Shown

Catalog Number	Accommodates Conductor Range			Reference Dimensions				Recommended Screw Torque (Inch Pounds)	
	Water Pipe	Ground	Hub Size	H	L	W	C	Pipe Clamp	Wire Clamp
C-61	1/2 - 1 [13-25]	#6 Sol. Max.	1/2 [13]	2.07" [53]	2.34" [59]	1.34" [34]	1.06" [27]	50 in.-lb.	50 in.-lb.
C-66	1-1/4 - 2 [32-51]	#6 Sol. Max.	1/2 [13]	2.69" [68]	3.62" [92]	1.34" [34]	1.40" [36]	50 in.-lb.	50 in.-lb.

Type C-LH
Cast Bronze Clamps for Conduit

For grounding rigid conduit systems. Continuity from rigid conduit systems to ground provided by cast bronze threaded conduit hub. Zinc plated screws.

- UL467 Listed for the US and Candian Markets



-2, -3 Versions*

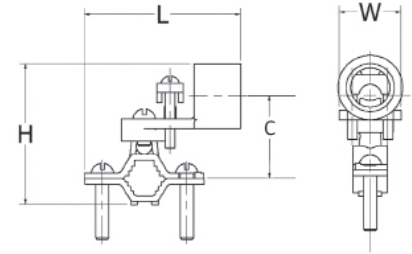

Catalog Number	Accommodates Conductor Range			Reference Dimensions				Recommended Screw Torque (Inch Pounds)	
	Water Pipe	Ground	Hub Size	H	L	W	C	Pipe Clamp	Wire Clamp
C-11LH-1	1/2 - 1 [13-25]	10 Str. - 6 Sol.	1/2 [13]	2.25" [57]	3.23" [83]	0.69" [18]	0.97" [25]	50 in.-lb.	50 in.-lb.
C-22LH-1	1-1/4 - 2 [32-51]	10 Str. - 6 Sol.	1/2 [13]	2.88" [73]	3.50" [89]	0.69" [18]	1.34" [34]	50 in.-lb.	50 in.-lb.
C-4LH-1	2-1/2 - 4 [54-102]	10 Str. - 6 Sol.	1/2 [13]	4.56" [116]	4.82" [122]	0.69" [18]	2.44" [62]	50 in.-lb.	50 in.-lb.
C-11LH-2	1/2 - 1 [13-25]	2/0 - 10 Str.	3/4 [19]	2.56" [65]	2.86" [73]	1.00" [25]	1.13" [29]	50 in.-lb.	50 in.-lb.
C-22LH-2	1-1/4 - 2 [32-51]	2/0 - 10 Str.	3/4 [19]	3.19" [65]	3.50" [89]	1.00" [25]	1.50" [38]	50 in.-lb.	50 in.-lb.
C-4LH-2	2-1/2 - 4 [64-102]	2/0 - 10 Str.	3/4 [19]	4.88" [124]	4.82" [122]	1.00" [25]	2.38" [60]	50 in.-lb.	50 in.-lb.
C-11LH-3	1/2 - 1 [13-25]	3/0 - 10 Str.	1 [25]	2.69" [68]	2.86" [73]	1.13" [29]	1.19" [30]	50 in.-lb.	50 in.-lb.
C-22LH-3	1-1/4 - 2 [32-51]	3/0 - 10 Str.	1 [25]	3.32" [59]	3.50" [89]	1.13" [29]	1.56" [40]	50 in.-lb.	50 in.-lb.
C-4LH-3	2-1/2 - 4 [64-102]	3/0 - 10 Str.	1 [25]	5.01" [127]	4.82" [122]	1.13" [29]	2.44" [62]	50 in.-lb.	50 in.-lb.

* C-LH with -1 has one screw; -2 and -3 Versions have 2 screws as shown.

Type C-CS
Cast Bronze Clamps with Copper Strap

For grounding rigid conduit systems. Strap helps protect conduit system from water system vibrations. Cast bronze clamp with zinc plated screws and ETP copper strap.

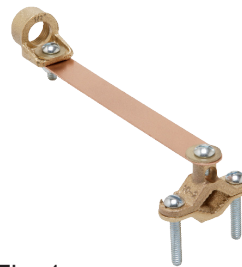

Fig. 1



Fig. 2

Catalog Number	Fig. #	Accommodates Conductor Range			Reference Dimensions					Recommended Screw Torque (Inch Pounds)	
		Water Pipe	Ground	Hub Size	H	L	W	C	D	Pipe Clamp	Wire Clamp
C-11CSH-1	1	1/2 - 1 [13-25]	6 Sol. Max.	1/2 [13]	1.75" [44]	8.50" [216]	1.06" [27]	1.06" [27]	6.12" [155]	50 in.-lb.	50 in.-lb.
C-11CSH-2	1	1/2 - 1 [13-25]	4/0 Str. Max.	3/4 [19]	1.75" [44]	8.50" [216]	1.25" [32]	1.50" [38]	6.12" [155]	50 in.-lb.	50 in.-lb.
C-11CSH-3	1	1/2 - 1 [13-25]	4/0 Str. Max.	1 [25]	1.75" [44]	8.50" [216]	1.50" [38]	1.75" [44]	6.12" [155]	50 in.-lb.	50 in.-lb.
C11CSLH12	2	1/2 - 1 [13-25]	2/0 Str. Max.	1/2 [13]	1.75" [44]	8.50" [216]	1.18" [30]	1.06" [27]	6.12" [155]	50 in.-lb.	45 in.-lb.

Type GC-A

Dual Rated Ground Clamp for Copper and Aluminum Cable

Type GC-A ground clamps are UL Listed for use with either copper or aluminum conductors to copper water pipe, galvanized pipe, or steel conduit. All clamps are constructed from tin plated high-strength extruded aluminum alloy. PENETROX™ oxide inhibiting joining compounds are recommended for all aluminum applications.

Features & Benefits

- Clamps are dual rated for both copper and aluminum conductors providing maximum flexibility of application
- All connectors are tin plated to provide low contact resistance and prevent galvanic corrosion
- All clamps are range taking; only 3 catalog number covers the complete range of applications from 1/2 to 4 inches
- UL467 Listed

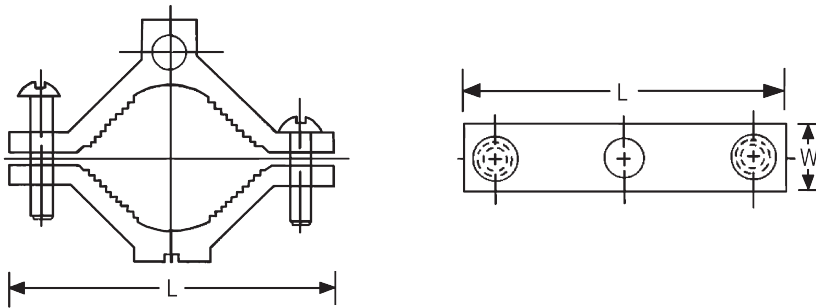
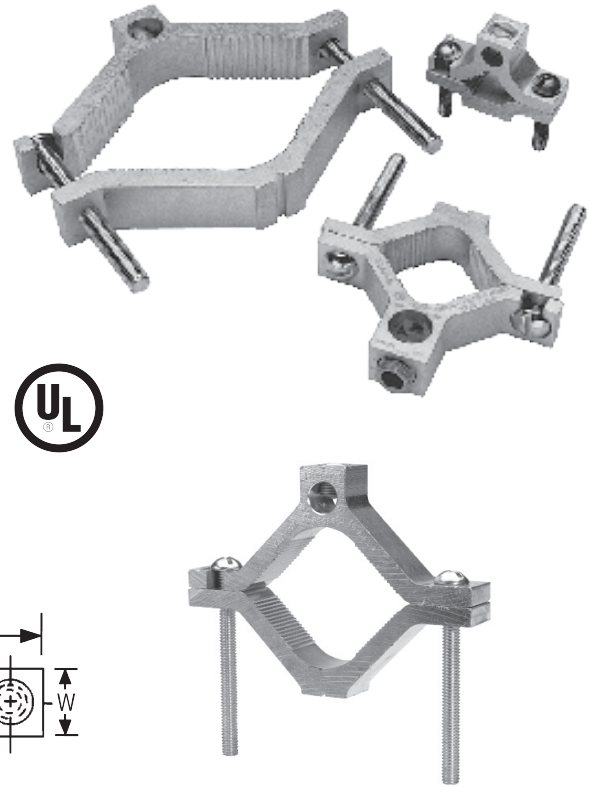

Catalog Number	Conduit, Pipe, or Water Tube Size**	Wire Range	Screw Type	W	L	Hex Size
GC15A	1/2 - 3/4 - 1	1/0 - 14	Slotted	11/16	2-1/4	Slot
GC18A	1-1/4 - 1-1/2 - 2	250 kcmil - 6	Hex Socket	13/16	3-3/4	5/16
GC22A	2-1/2 - 3 - 3-1/2 - 4	250 kcmil - 6	Hex Socket	1	6-5/16	5/16

NOTE:

** Refer to Section O for tube dimensions.

Type BDT, House or Meter Socket Mounted BONDIT® Intersystem Bonding Connector

Designed to meet the requirements of NEC Article 250.94 "Bonding for Other Systems". Corrosion-resistant stainless steel set screws. Accepts main ground wire (#2-#8) and up to 4 intersystem wires (#6-#14). Same design can be mounted directly to the meter socket or mounted to the house. Innovative design does not damage meter socket and will not void warranty.

Catalog Number: **BDT1**

Features & Benefits

- Made in the USA!
- Meets Intersystem Bonding Requirements; NEC 250.94
- One connector does it all
- House mount or meter socket mount
- Incorporates proven BURNDY® SERVIT POST™ design
- Stainless steel set screws
- UL467 Listed

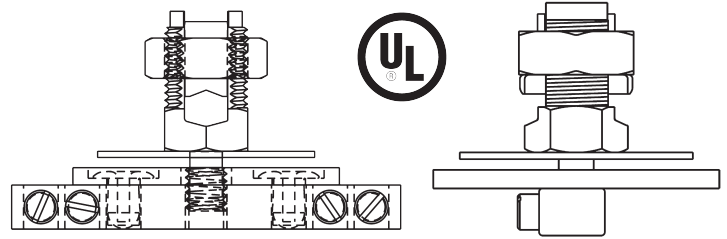

- Accepts main ground wire (#2-#8), up to 4 intersystem wires (#6-#14)
- Easily mounts to meter box during new installation or can be wall mounted
- Easy to follow instructions included
- Does not damage meter socket; no worries about damaging the paint or voiding warranties
- Easily installed with a wrench and screwdriver
- Open design prevents buildup of hornets, bees, spiders

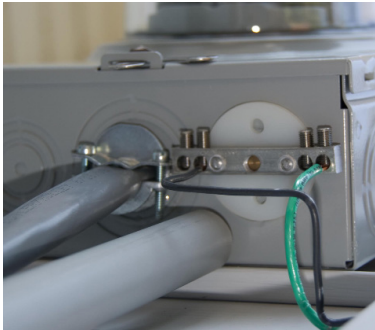

CONFIGURATION 1 - MOUNTED TO ENCLOSURE

1. Punch out a 1/2" or 3/4" knock out on the electrical enclosure.
2. Begin assembly by installing the ground electrode conductor in the SERVIT POST™ inside the electrical enclosure. Torque on SERVIT® NUT: 275 in-lb max.
3. Install the rest of the connector shown below, it is not necessary for the bus bar to be aligned parallel with the enclosure. (Note: the split washer is not used in this configuration.)
4. Tighten the intersystem ground wires with set screws in the bus bar to a maximum torque of 35 in-lb.
5. Adhere the BONDIT® location sticker to the front of the electrical enclosure.

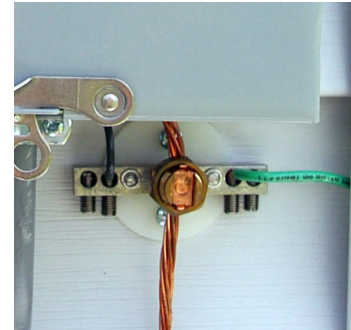
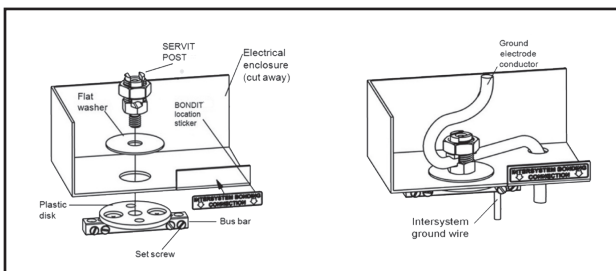

CONFIGURATION 2 - MOUNTED TO EXTERIOR WALL

1. Begin by assembling the connector as shown in figure below. Be sure SERVIT POST™ is as tight as it can be while its groove is aligned with the ground electrode conductor. (Note: the flat washer is not used in this configuration.)
2. Use two mounting screws (not included) to secure the connector to the exterior wall so that the set screws in the bus bar face downward.
3. Install the ground electrode conductor into the SERVIT POST™ while turning the nut/pressure bar assembly to a maximum torque of 275 in-lb (use 2 wrenches if necessary).
4. Tighten the intersystem ground wires with the set screws in the bus bar to a maximum torque of 35 in-lb.
5. If hidden from view, use the BONDIT® location sticker to indicate the location.

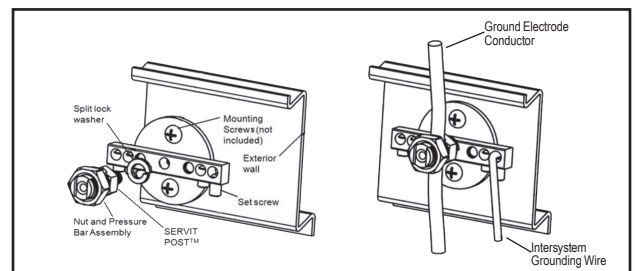

Type BDTIBB, BONDIT® Wall Mounted Intersystem Bonding Connector

NEC 250.94 refers to a requirement in the 2008 National Electrical Code. In the past, ground wires from telephone systems or cable systems were allowed to be grounded separately from the GEC (Ground Electrode Conductor from the main electrical service). With the new code, all ground wires from separate systems such as telephone systems, CATV and radio systems must be tied together at one location to the GEC. Hence, the term intersystem refers to tying all of the “system” grounds together in one location. The BONDIT® - Wall Mount is a great solution when the GEC is exposed (not in conduit).

With the new BONDIT® - Wall Mount connector BURNDY provides an economical solution that meets the needs of NEC 250.94.

Features & Benefits

- Meets Intersystem Bonding Requirements; NEC 250.94
- Provides an easy to access grounding point for utilities such as telecom and cable
- Easy to install
- Tin-plated connector body provides long-lasting corrosion resistance
- UL467 Listed for the US and Canadian Markets
- Stainless steel set screws
- Accepts main ground wire (#2 to #6), up to (4) intersystem wire (#4 to #14)
- Supplied with a durable cover, easily secured over connector body
- Approved for use with solid stranded conductors

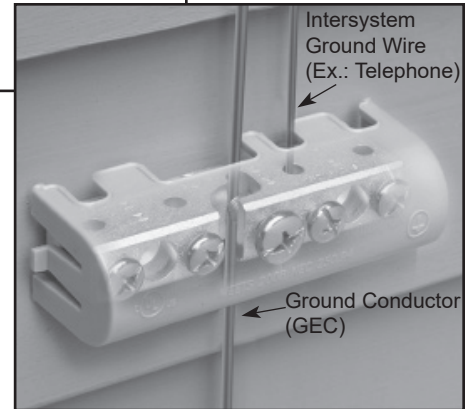
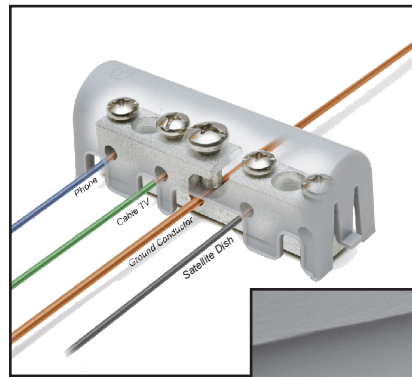

Catalog Number	Figure	Cover Color	Conductor Range		Reference Dimensions			
			Lay-In Section	Conductor Ports	L	W	H	M
BDTIBB	1	Gray	#6 - #2 AWG	#14 - #4 AWG	3.99 [101]	0.71 [18]	0.91 [23]	2.46 [62]
GIB5	2	White	#6 - #2 AWG	#14 - #4 AWG	3.39 [86]	1.50 [38]	0.91 [23]	2.13 [54]

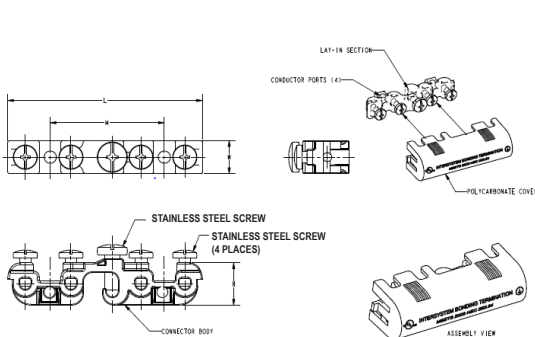

Figure 1

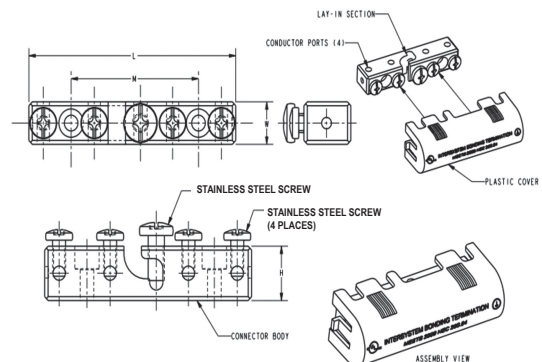
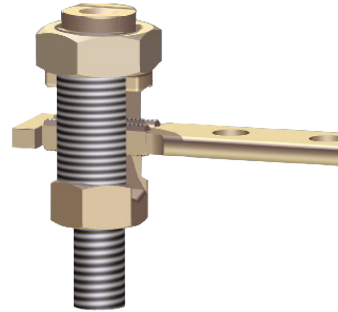

Figure 2

Type SB, HandyBug™ Connector
Tap, Splice, Terminate all with the same connector

The HandyBug™ connector is an “all-in-one” electrical connector that can be used for dozens of different power or grounding connection applications. This new connector is the survival tool of electrical connections and can be used as a splice, tap, terminal, wire-to-pipe, wire-to-busbar, and many other applications. The HandyBug™ incorporates the features and benefits of dozens of different products. Available in two sizes, these connectors accommodate from #8 AWG Solid to 1/0 AWG Stranded.

Ideal for emergency repairs, maintenance crews, and technicians, this connector is an essential part of every electrician/s basic supplies. cULus Listed and acceptable for direct burial in earth and concrete.



Traditional Split Bolt Option

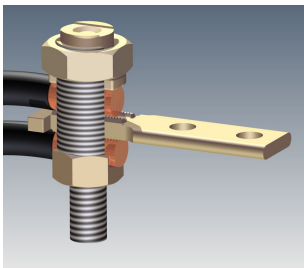

Terminate 1 or 2 Wires

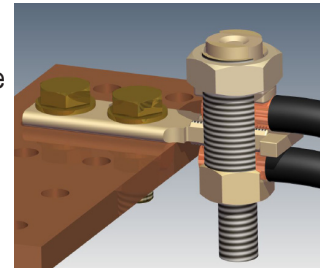

Splice Connection

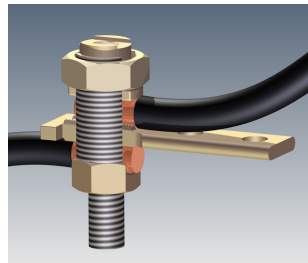

Wire to Pipe or Steel

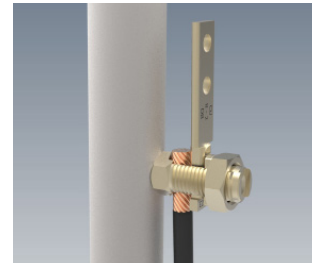

Features & Benefits

- Power or Grounding and Bonding Applications
- Can be used to terminate wire to bus bars or steel
- Can be used for splicing and tap connections
- No special tooling required
- UL467 and UL486A/B Listed for the US and Canadian markets
- Rated for Direct Burial
- Tin plated
- Industry standard mounting hole configurations

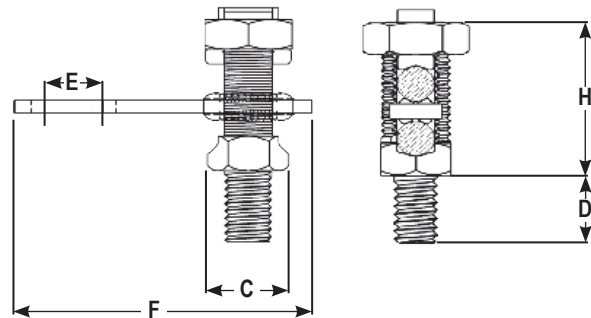

Catalog Number	Stranded	Solid	Stud Diameter	C	H	D	E	F
SB232TC14	8 AWG - 2 AWG	8 AWG - 2 AWG	3/8 - 16	0.72 [18]	1.44 [37]	0.63 [16]	0.63	2.84
SB232TC38	8 AWG - 2 AWG	8 AWG - 2 AWG	3/8 - 16	0.72 [18]	1.44 [37]	0.63 [16]	1.00	2.84
SB23U*	8 AWG - 2 AWG	8 AWG - 2 AWG	3/8 - 16	0.72 [18]	1.44 [37]	0.63 [16]	N/A	2.84
SB252TC14	2 AWG - 1/0 AWG	2 AWG - 1/0 AWG	1/2 - 13	0.87 [22]	1.68 [43]	0.75 [19]	0.63	3.15
SB252TC38	2 AWG - 1/0 AWG	2 AWG - 1/0 AWG	1/2 - 13	0.87 [22]	1.68 [43]	0.75 [19]	1.00	3.15
SB25U*	2 AWG - 1/0 AWG	2 AWG - 1/0 AWG	1/2 - 13	0.87 [22]	1.68 [43]	0.75 [19]	N/A	3.15

* Suffix U denotes undrilled version, not cULus Listed.

Mechanical Grounding

Type BWB680 Series Pool Water Bonding Kits

Type BWB680 Series BURNDY® Pool Water Bonding Kits

NEC 680.26(C) states: "An intentional bond of minimum conductive surface area of 9" shall be installed in contact with the pool water. This bond shall be permitted to consist of parts that are required to be bonded in 680.26(B)".

In order to comply with this requirement BURNDY is offering the BWB680 Series. Made of non-corrosive stainless steel, the BURNDY water bonding kit maintains constant contact with pool water to ensure that the pool is effectively bonded at all times.

BURNDY BWB680 Series is one of the few and the most user friendly, products on the market that complies with this code. Other products are placed in the plumbing, which is not always in contact with the water and therefore does not meet the code. Since the BWB680 Series is placed in the skimmer, it is always in contact with the water.

Included in the BURNDY BWB680 Series Bonding Kit: One (1) bonding plate; one (1) rubber sealing washer; two (2) flat washers; two (2) lock washers; two (2) nuts; and one (1) BURNDY CL501-TN.

Features & Benefits

- Easy installation
- Mounting hardware included
- UL Listed
- Placed out of the way on the side wall of the skimmer below the basket

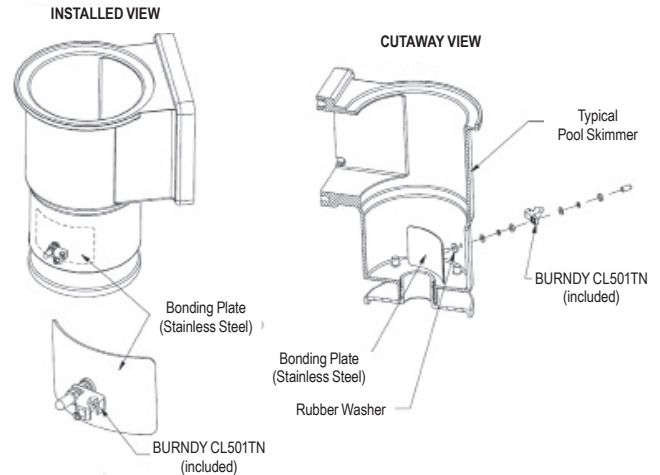

Catalog Number	Pool Type
BWB680AG	Above Ground
BWB680IG	In-Ground

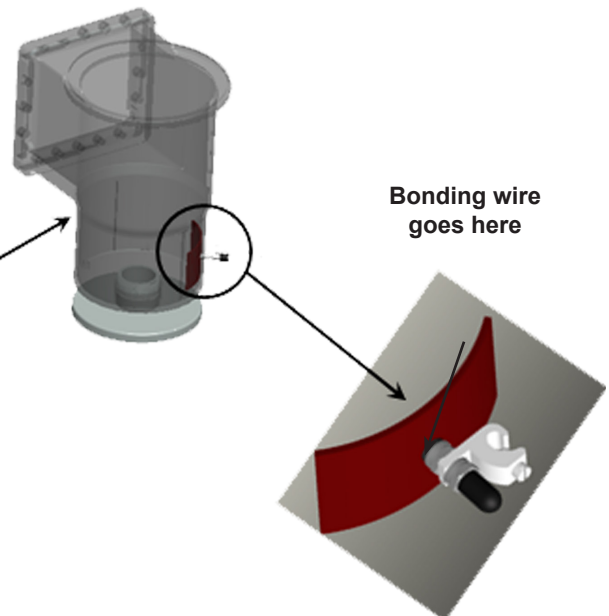
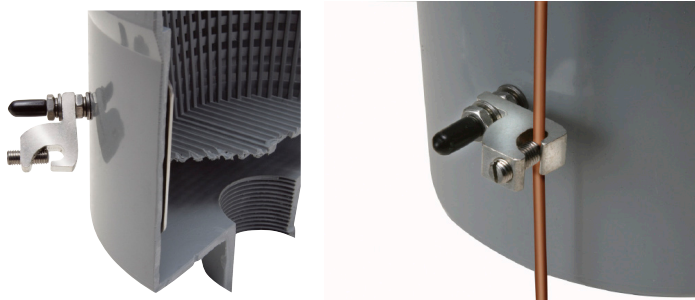

Type QGFL BARTAP™ Copper Cable to Flat Bar or Pad

High copper alloy BARTAP™ for joining a range of cable to bar or pad. One-wrench installation. DURUM™ silicon bronze nut and lockwasher. Can be installed side by side or in line on a NEMA drilled bar.

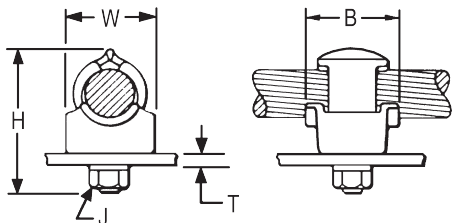
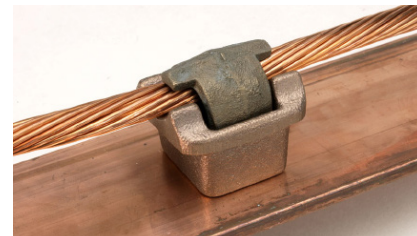

Catalog Number	Copper Conductor	B	H	J	T (Max)	W
QGFL1CB1	#10 Sol. - #1 Str.	1-1/8	1-7/8	3/8	1/4	1
QGFL1CB1T6	#10 Sol. - #1 Str.	1-1/8	2-3/8	3/8	3/4	1
QGFL26B1	#8 Sol. - #2/0 Str.	1-1/4	2-1/8	3/8	1/4	1-1/8
QGFL26B1T6	#8 Sol. - #2/0 Str.	1-1/4	2-5/8	3/8	3/4	1-1/8
QGFL26B2*	#8 Sol. - #2/0 Str.	1-1/4	2-8/25	1/2	1/4	1-1/8
QGFL26B2T6*	#8 Sol. - #2/0 Str.	1-1/2	2-40/50	1/2	3/4	1-1/8
QGFL29B1*	#6 Str. - 250 kcmil	1-2/5	2-5/8	1/2	1/4	1-3/8
QGFL29B1T6*	#6 Str. - 250 kcmil	1-5/8	3-1/8	1/2	3/4	1-3/8
QGFL31B1*	2 AWG - 350 kcmil	1-3/4	2-7/8	1/2	1/4	1-5/8
QGFL31B1T6*	2 AWG - 350 kcmil	1-3/4	3-1/4	1/2	3/4	1-5/8
QGFL34B1	1/0 AWG - 500 kcmil	2	3-1/8	1/2	1/4	1-3/4
QGFL34B1T6	1/0 AWG - 500 kcmil	2	3-5/8	1/2	3/4	1-3/4
QGFL39B1	350 kcmil - 750 kcmil	2-1/4	3-1/4	1/2	1/4	1-3/4
QGFL39B1T6	350 kcmil - 750 kcmil	2-1/4	3-5/8	1/2	3/4	1-3/4
QGFL44B1	750 kcmil - 1000 kcmil	2-1/4	3-3/8	1/2	1/4	2-1/8
QGFL44B1T6	750 kcmil - 1000 kcmil	2-1/4	4-1/8	1/2	3/4	2-1/8
QGFL46B1	1000 kcmil - 1500 kcmil	2-1/4	4	1/2	1/4	2-1/2
QGFL46B1T6	1000 kcmil - 1500 kcmil	2-1/4	4-1/2	1/2	3/4	2-1/2
QGFL48B1	1500 kcmil - 2000 kcmil	2-1/4	4-3/4	1/2	1/4	3

* Can be installed side by side or in line on NEMA drilled bar.

Type GNAH Grounding Terminal

Cast copper alloy grounding terminal for equipment grounding-type applications. 2-hole NEMA drilling (1/2" holes, 1-3/4" center to center) on tongue. Qualified to IEEE 837-2014

Catalog Number	Cable	L	H	W	J	Rec. Torque
GNAH292N	#6 Sol - 250 kcmil Small Groove: #6 Sol - 1/0 Str Large Groove: 2/0 Str - 250 kcmil	5.88"	2.26"	2.44" (large groove)	1/2"	480

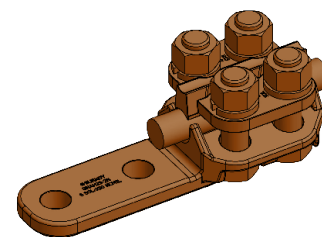

Types J, RGC Mechanical Rail Connectors

Mechanical clamp connectors designed for use in power, contact or running rail applications. Connectors are cast of a high conductivity copper alloy, tin-plated, and assembled with high-strength DURUM™ hardware. Connectors designed for extended service life.

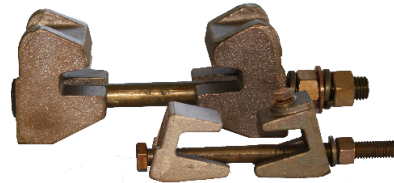

Figure 1

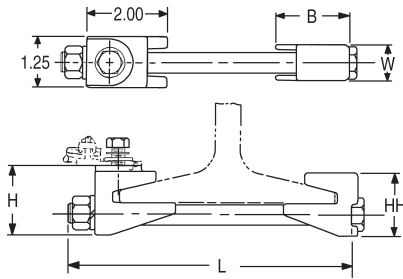

Figure 2

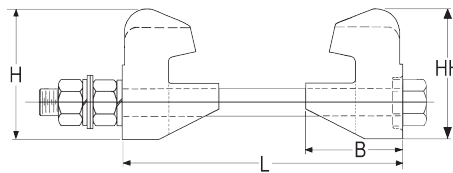

Figure 3

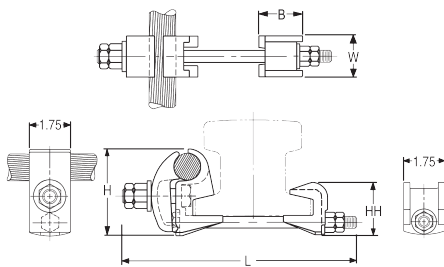

Figure 4

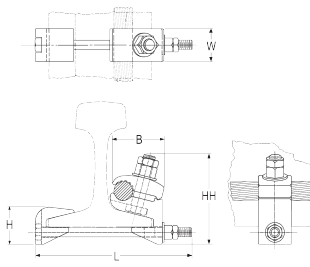
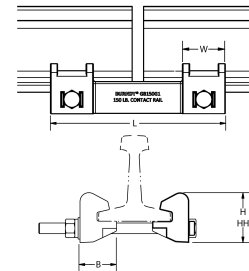

Figure 5



Catalog Number	Fig. No.	Accommodates	B	H	HH	L	W
J278	1	100 Lbs. A.R.E.A Running Rail	1.81	1.88	1.72	7.50	0.88
J278G1	1	100 Lbs. A.R.A. Running Rail	1.81	1.88	1.72	8.00	0.88
J279	1	75 or 90 Lbs. Running Rail	1.81	1.71	1.55	7.50	0.88
J280	1	150 Lbs. Contact Rail	2.12	2.08	1.92	7.00	1.25
J295	2	150 Lbs. Third Rail	2.62	3.50	3.50	7.75	3.00
RGC44G1 ①	3	150 Lbs. NMC Contact Rail and (1) 800-1000 kcmil CU Cable	1.75	2.82	2.25	10.00	1.75
RGC39G1 ①	4	115 Lbs. Contact or Running Rail and (1) 500-750 kcmil CU Cable	2.75	2.00	4.78	8.32	1.25
GB150G2	5	Third Rail Splice Clamps Two 150 Lb Contact Rails	2.56	3.50	3.50	12.25	3.00
GB150G3			2.56	3.50	3.50	23.00	3.00

① Tin-plated

CPI™ Running Rail Connectors
 Single and Two-Conductor Styles

CPI Running Rail Connectors are designed as a permanent connection for copper conductor to a variety of rails used in Heavy Rail Mass Transit systems. Constructed with a heavy duty aircraft-quality steel spring member, copper cable nest, indenter, hex head bolt and locking nut.

Features and Benefits

- No drilling in rail or need to weld conductor to the rail!
- Rail is not subjected to warping by excessive heat or to weakening by drilling
- Labor saving, installation time can take as little as 10 minutes per connection
- Fewer rail connections required due to large conductor capacity (Single conductors up to 1000 kcmil; Dual conductors up to 750 kcmil)
- Large conductors can be bent away from the rail after installation without the risk of damaging the connector
- The clamp is an active spring applying a consistent force on the conductor ensuring a positive connection through heat cycling and train vibration
- The J-shaped spring member of the connector helps overcoming loosening issues problems associated with harsh train vibration by flexing rather than breaking; a static-type connection doesn't have this resiliency and could crack under prolonged vibration
- Consistent spring pressure prevents moisture and contamination from seeping into the connection
- All copper components are tin plated and steel components are galvanized

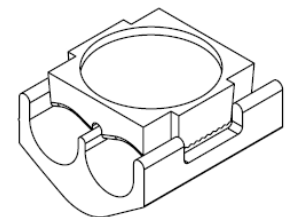
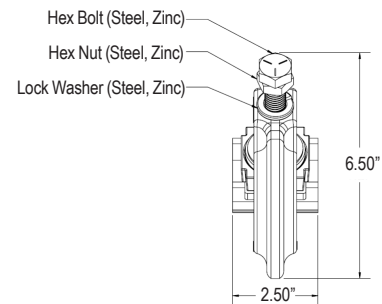
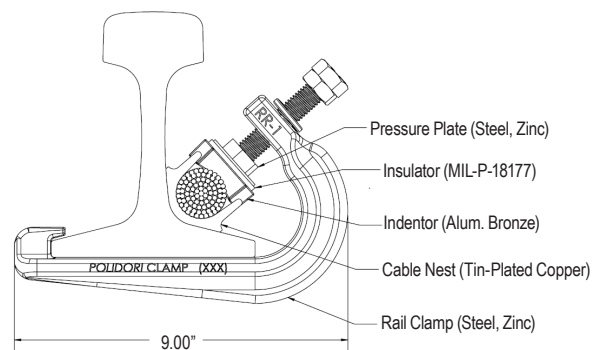
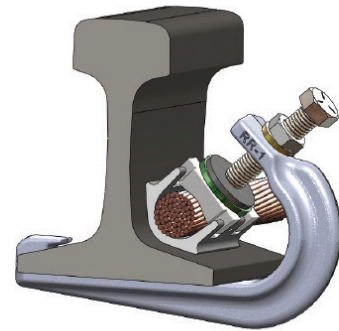

115-2-500 Nest Configuration

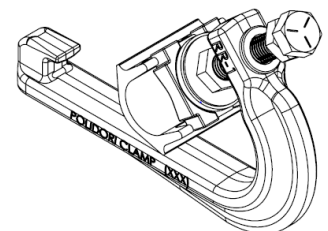

115-1000A Nest Configuration

Single Conductor Connectors		
Catalog Number	Rail Size & Type	Conductor Size Range
85-1000	85 lb ASCE	1000 kcmil
90-1000	90 lb ASCE	1000 kcmil
115-500	115 lb AREMA, 119 lb AREMA	500 kcmil
115-750	115 lb AREMA, 119 lb AREMA	750 kcmil
115-1000A	115 lb AREMA, 119 lb AREMA	1000 kcmil - 1250 kcmil
136-500	136 lb AREMA	500 kcmil
Two Conductor Connectors		
85-2-500	85 lb ASCE	TWO: 250 kcmil - 500 kcmil
90-2-500	90 lb ASCE	TWO: 250 kcmil - 500 kcmil
115-2-500	115 lb AREMA, 119 lb AREMA	TWO: 250 kcmil - 500 kcmil
115-2-750	115 lb AREMA, 119 lb AREMA	TWO: 750 kcmil
136-2-500	136 lb AREMA	TWO: 250 kcmil - 500 kcmil

Contact the factory for any rail or conductor combination not listed

CPI™ Contact Rail Connectors Single and Two-Conductor Styles

CPI Contact Rail Connectors are designed as a permanent connection for copper conductor to a variety of rails used in heavy rail Mass Transit systems. Constructed using a heavy duty aircraft-quality steel spring member, copper cable nest, indenter, hex head bolt and locking nut.

Features and Benefits

- No drilling in rail or need to weld conductor to the rail!
- Rail is not subjected to warping by excessive heat or to weakening by drilling
- Labor saving, installation time is 1/6 man hours
- Fewer rail connections required due to large conductor capacity (Single conductors up to 2000 kcmil; Dual conductors up to 750 kcmil)
- Large conductors can be bent away from the rail after installation without the risk of damaging the connector
- The clamp is an active spring applying a consistent force on the conductor ensuring a positive connection through heat cycling and train vibration
- The J-shaped spring member of the connector helps overcoming loosening issues problems associated with harsh train vibration by flexing rather than breaking; a static-type connection doesn't have this resiliency and could crack under prolonged vibration
- Consistent spring pressure prevents moisture and contamination from seeping into the connection
- All copper components are tin plated and steel components are galvanized

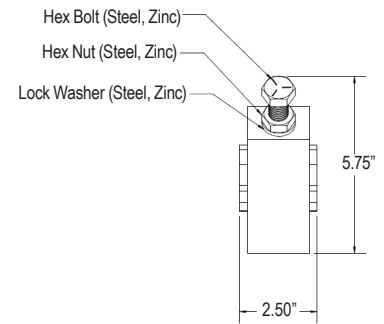
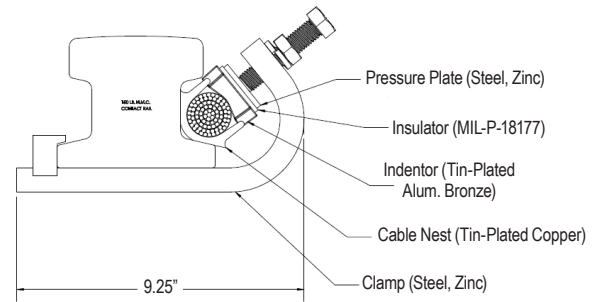
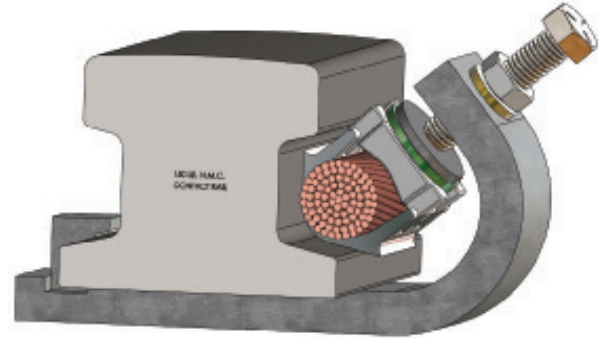

Single Conductor Connectors		
Catalog Number	Rail Size & Type	Conductor Size Range
150-1000	150 lb NMC	1000 kcmil
150-2000	150 lb NMC	2000 kcmil
Two Conductor Connectors		
150-2-500	150 lb NMC	TWO: 250 kcmil - 500 kcmil

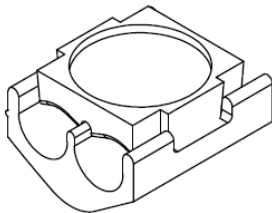

150-2-500 Nest Configuration

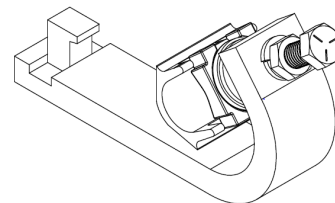

150-1000 Nest Configuration

CPI™ 2000 kcmil Cathode Connector “Pot Head” Connector

CPI Cathode Connector (also known as “Pot Head” connector) is designed to connect a single 2000 kcmil conductor from the main feeder directly to the Third Rail. Used in conjunction with the CPI Contact Rail Clamp, a Pot Head connector can replace the need for having 4 separate 500 kcmil connections with one single 2000 kcmil connection.

Features and Benefits

- Constructed of high conductivity copper
- The assembly comes standard with a tin-plated finish (image shows unplated)
- Incorporates the use of stainless steel hardware for increased strength and corrosion resistance
- Optional molded fiberglass cover is also available
- Simple 4-bolt installation
- Eliminates the need for any welding
- Recommended for use with the CPI 2000 kcmil Contact Rail Connector

Catalog Number	Description
22000	2000 kcmil Cathode Connector
750336	Fiberglass Insulated Cover

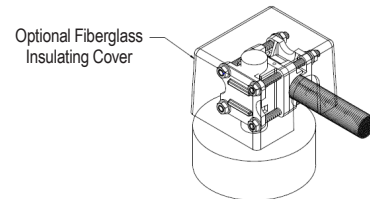
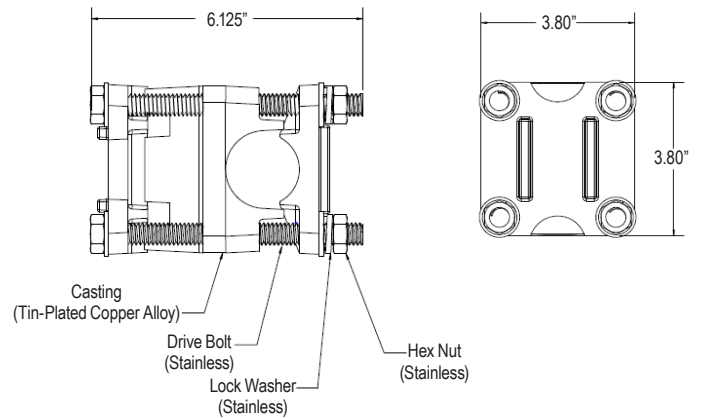
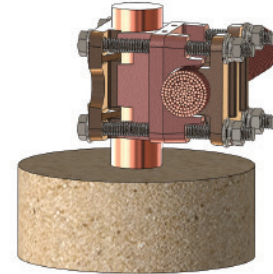

CPI™ Single Cable Support Spring Rail Clips Support for Signal Cables Near Rail

CPI Support Spring Rail Clips are designed to support and hold a variety of Signal cables or conductors in close proximity to the rail.

Features and Benefits

- Tempered spring steel wire construction
- All components are plated or galvanized to resist corrosion
- Quick and easy to install
- Removable and reusable
- Available in different configurations to accommodate different size rails and multiple conductor combinations

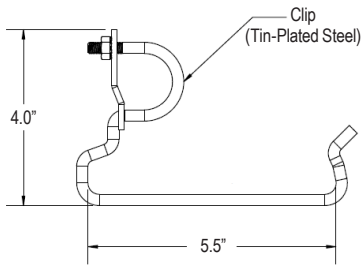
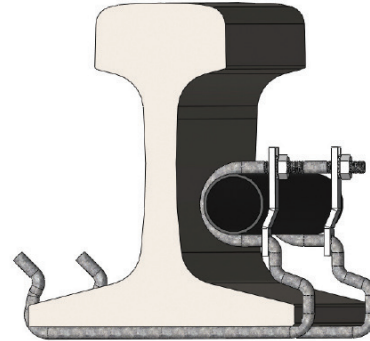

Figure 1

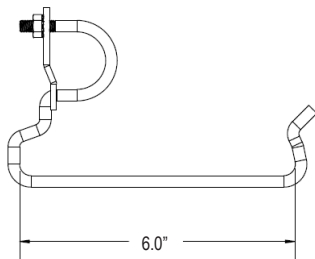

Figure 2

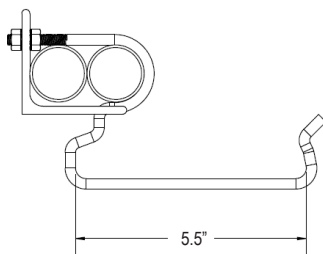

Figure 3

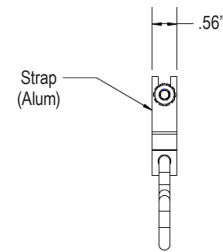

Figure 4

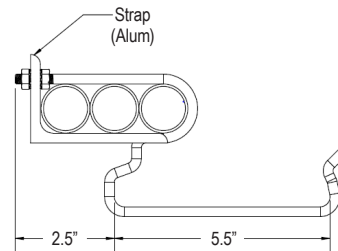
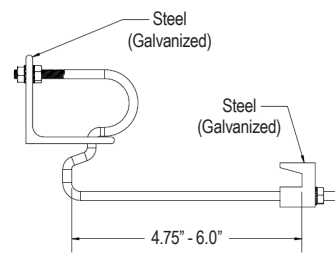

Figure 5



Catalog Number	Figure	Rail Size & Type	Cable O.D. & Capacity
115-250	1	115 lb AREA	1.25" x 1
140-375	2	140 lb AREA	1.375" x 1
115-250-2S	3	115 lb AREA	1.095" x 2 - 1.365" x 2
115-250-3	4	115 lb AREA	1.302" x 3
100-ARA-B-250-2	5	100 ARA-B	1.095" x 2 - 1.365" x 2

Options:

Add Suffix "N" to specify a stainless steel nylon insert nut. (Standard is Zinc-plated kept nuts.)

Types GB, GBM, GBH

Ground Connector for Copper Cable to Bar

High copper alloy ground connector for joining a range of cable to 1/4" thick bar.* Type GB separates cable from bar, GBM clamps cable directly on bar surface. The high copper alloy cast body and DURIMUM™ silicon bronze bolts, nuts, and lockwashers make the GB, GBM and GBH suitable for direct burial in concrete or ground. Types GBH area heavy duty connectors qualified to IEEE837-2014. See Note at the bottom of the page.

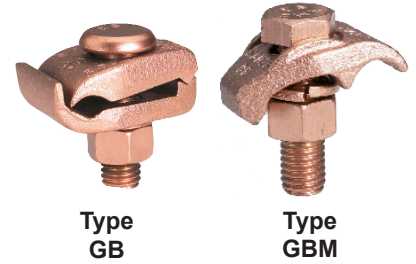
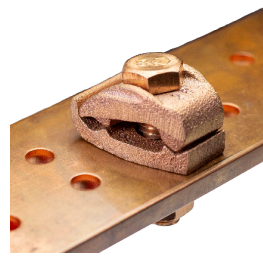

- Rated for Direct Burial in earth or concrete
- UL467 Listed for the US and Canadian Markets ①
- One wrench installation
- Select connectors qualified to IEEE-837-2014

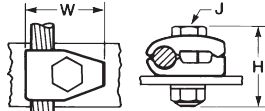

Type GB

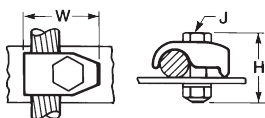

Type GBM

Catalog Number		Cable	H Type GB / GBL	H Type GBM	J	W Type GB/ GBL	W Type GBM	Rec. Torque
Type GB	Type GBM							
GB4C	GBM4C	8 AWG-4 AWG	1-1/2	1-1/2	3/8	1-1/4	1-1/4	240
GB26	GBM26	4 AWG-2/0 AWG	2	1-1/2	3/8	1-1/2	1-1/2	240
GBL30 ①	—	4 AWG-300 kcmil	2	—	1/2	1-7/8	—	480
GB29	GBM29	2/0 AWG-250 kcmil	2	2	1/2	2	2	480
GB34	GBM34	300 kcmil-500 kcmil	3	2-1/4	1/2	2-3/8	2-3/8	480
GBH26 ②	-	#4 SOL - 2/0 STR	2-1/3	-	1/2	1-1/2	-	480

① GBL30 is not UL Listed

② Qualified to IEEE837-2014

Types GC, GCM, GCH

Ground Connector for Two Copper Cables to Bar

High copper alloy ground connector for joining a wide range of two parallel cables to 1/4" thick bar.* Type GC, GCH separates cable from bar, GCM clamps cable to bar surface. The high copper alloy cast body and DURIMUM™ silicon bronze bolts, nuts, and lockwashers make the GC, GCM and GCH suitable for direct burial in concrete or ground. Types GCH area heavy duty connectors qualified to IEEE837-2014. See Note at the bottom of the page.

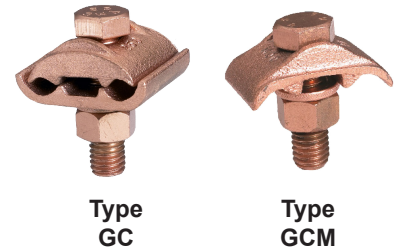
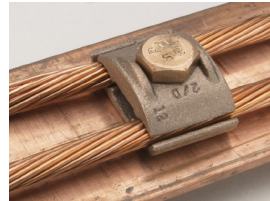

- Rated for Direct Burial in earth or concrete
- UL467 Listed for the US and Canadian Markets
- One wrench installation
- Select connectors qualified to IEEE-837-2014

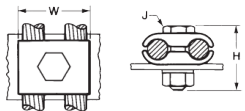

Type GC, GCH

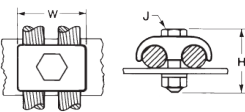

Type GCM

Catalog Number		Cable	H Type GC	H Type GCM	J	W Type GC/GCL	W Type GCM	Rec. Torque
Type GC	Type GCM							
GC4C4C	GCM4C	8 AWG-4 AWG	1-1/2	1-1/2	3/8	1-3/8	1	240
GC2626	GCM26	4 AWG-2/0 AWG	2	1-1/2	3/8	1-3/4	1-3/8	240
GCL30	—	5 AWG-300 kcmil	2	—	1/2	1	—	480
GC2929	GCM29	2/0 AWG-250 kcmil	2-1/4	2	1/2	2-1/4	2	480
GC3434	GCM34	300 kcmil-500 kcmil	2-7/8	2-1/4	1/2	2-7/8	2-5/8	480
GCH2626 ①	-	#4 SOL - 2/0 STR	2-1/3	-	1/2	1-7/9	-	480

① Qualified to IEEE837-2014

NOTE:

The **GB, GBM, GC, GCM, GL** and **GZ** are all used for joining a range of cable to bar. The catalog numbers in each table accommodate the indicated cable range and up to 1/4" thick bar. Optional bolt lengths are available to accommodate up to 1" thick bar. For bar thicknesses from 1/4" to 1/2", add the suffix "T4" to the catalog number in the table. For bar thicknesses from 1/2" to 1", add the suffix "T8" to the catalog number in the table.

Mechanical Grounding

Type GL for Two Copper Cables to Bar;
Type GZ for Copper Cable to Bar

Type GL

Ground Connector for Two Copper Cables to Bar

High copper alloy ground connector for joining a wide range of two parallel cables to 1/4" thick bar.* Two-bolt design, separates cable from bar. The high copper alloy cast body and DURIMUM™ silicon bronze bolts, nuts, and lockwashers make them suitable for direct burial in concrete or ground. See Note at the bottom of the page.

- Rated for Direct Burial in earth or concrete
- UL467 Listed
- One wrench installation

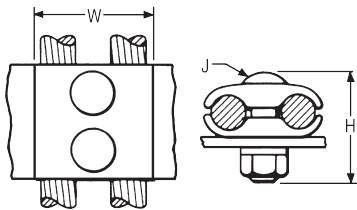
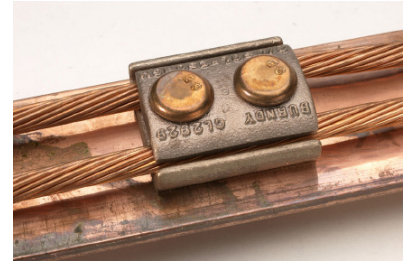
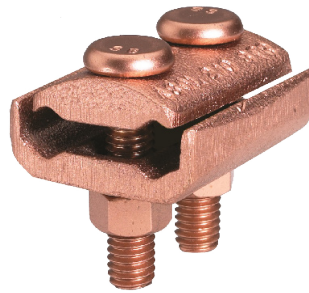

Catalog Number	Conductor	H	J	W
GL4C4C	8 AWG-4 AWG	1-1/2	3/8	1-3/8
GL2626	4 AWG-2/0 AWG	2	3/8	1-3/4
GL2929	2/0 AWG-250 kcmil	2-1/4	1/2	2-1/4
GL3434	300 kcmil-500 kcmil	2-7/8	1/2	2-7/8

Type GZ

Ground Connector for Copper Cable to Bar

High copper alloy ground connector for joining a wide range of cable to 1/4" thick bar*. Cable is gripped by curving it around the clamping bolt in connector groove. The high copper alloy cast body and DURIMUM™ silicon bronze bolts, nuts, and lockwashers make them suitable for direct burial in concrete or ground. See Note at the bottom of the page.

- Rated for Direct Burial in earth or concrete
- UL467 Listed for the US and Canadian Markets

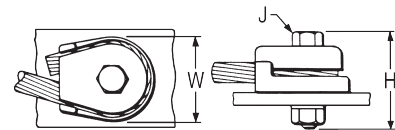
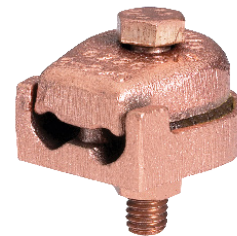

Catalog Number	Conductor	H	J	W
GZ4C-38	8-4	1-1/2	3/8	1-1/8
GZ4C-12	8-4	1-7/8	1/2	1-3/4
GZ4C-58	8-4	2	5/8	1-3/4
GZ26-38	3-2/0	2	3/8	1-5/8
GZ26-12	3-2/0	2-1/8	1/2	1-3/4
GZ26-58	3-2/0	2-1/4	5/8	1-3/4
GZ29-38	3/0-250	2-1/4	3/8	2-1/4
GZ29-12	3/0-250	2-3/8	1/2	2-1/4
GZ29-58	3/0-250	2-1/2	5/8	2-1/4

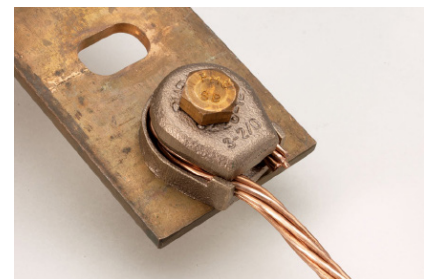

NOTE:

The **GB**, **GBM**, **GC**, **GCM**, **GL** and **GZ** are all used for joining a range of cable to bar. The catalog numbers in each table accommodate the indicated cable range and up to 1/4" thick bar. Optional bolt lengths are available to accommodate up to 1" thick bar. For bar thicknesses from 1/4" to 1/2", add the suffix "T4" to the catalog number in the table. For bar thicknesses from 1/2" to 1", add the suffix "T8" to the catalog number in the table.

Type GIE-G Ground Connector for Vehicle Grounding, Heavy Duty Construction

High-strength copper alloy ground clamps for grounding gasoline trucks, tank cars, aircraft and other vehicles where danger of explosion due to static electricity exists. Corrosion resistant and supplied with nonsparking, adjustable, replaceable contact grip screws. Automatic safety release disconnects should a vehicle unexpectedly move from the grounded area. Accommodates 4 Str. flexible copper cable.

Catalog Number	Description	Material	Point Configuration
GIE4CG3	Assembly Beryllium Copper	Beryllium Copper	Assembly
GIE4CG4	Assembly Stainless Steel	Stainless Steel	Assembly

Replacement Tips Only			
Catalog Number	Description	Material	Point Configuration
GIE4CG3P5	Beryllium Copper CONE Point Only	Beryllium Copper	Cone Point
GIE4CG3P7	Beryllium Copper CUP Point Only	Beryllium Copper	Cup Point
GIE4CG4P5	Stainless Steel CONE Point Only	Stainless Steel	Cone Point
GIE4CG4P7	Stainless Steel CUP Point Only	Stainless Steel	Cup Point

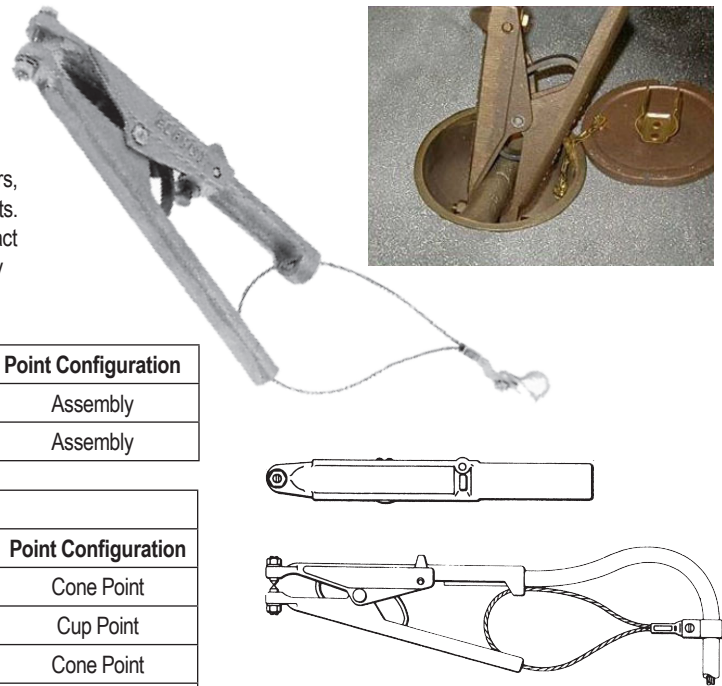

Type GIE-G Ground Connector for Vehicle Grounding, Heavy Duty Construction

Accommodates flexible rubber sheath cable ranging from #6 to #2 conductor.

Catalog Number: **GIE2CG3**

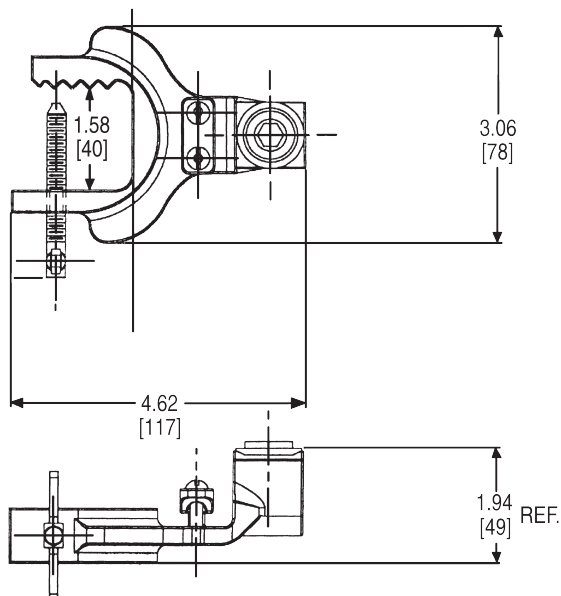

Type BSD BURNDY® Static Discharge Reels

Static Discharge Reels are an excellent addition to the BURNDY® static discharge line of products. These reels are often used to dissipate static charge buildup developed while filling or dispensing fuel or other combustible liquids from fuel trucks or rail cars. Often used in the petroleum industry but applicable in any area where static discharge creates potential hazard.

These reels are heavy duty, of rugged construction and are supplied with a 100 amp universal jaw-type grounding clamp. The reels are available with 100 ft and 50 ft lengths. All reels come with spring rewind and centrifugal brake. The tension can be adjusted on these reels and installation instructions are included to ensure the most efficient mounting method.

Every reel is Proudly Made in the USA and meets the stringent quality expectations of the BURNDY® portfolio of grounding products.

Features & Benefits

- 100 foot and 50 foot cable lengths available
- Automatic E-Z PULL™ Rewinding
- Rugged Steel Construction
- Compact Enclosed Design (excluding BSD20100)
- Positive Ratchet Lock with Ratchet On/Off Switch (excluding (BSD20100)
- Permanent Ratchet Lock (BSD20100 only)
- Steel Cable Installed
- 100 Amp Universal Jaw-Type Grounding Clamp
- Red Baked-on Finish
- Made in the USA



BSD2050

BSD2050N



BSD2050Y



BSD20100

Catalog Number	Cable Length	# of Jaw-Type Grounding Clamps	Weight (lb.)
BSD20100	100 feet (Open Reel Design)	1	20
BSD2050	50 feet	1	12
BSD2050N	50 feet (Nylon Covered)	1	12
BSD2050Y	35 feet plus 15 feet of "Y"	2	13

Repair Component Kits

Catalog Number	Includes:
BSD2050K01	Spring motor assembly: spring motor, spool, shaft, bushings in a sealed canister
BSD2050K02	Right half housing assembly: right housing half, ratchet lock assembly (attached to housing)
BSD2050K03	Left half housing assembly: left housing half, nameplate
BSD2050K04	Cable guide
BSD2050K05	Cable assembly: cable, grounding clamp(s), lockwasher-M4, hex nut-M4
BSD2050K06	Hardware package: spacer, torsion spring, machine screws, lockwasher, thrust washer, hex nut, retaining ring, extension spring, ratchet lock assembly
BSD2050K05Y	Cable assembly: two cable grounding clamps, lockwasher-M4, hex nut-M4
BSD2050K05N	Cable assembly: nylon covered cable, grounding clamp, lockwasher-M4, hex nut-M4

Type BSDCCEE Static Discharge "C" Clamp

The BSDCCEE is a static grounding "C" clamp used to provide electrical contact between containers used for dispensing liquids and the grounding grid. The reel or grounding cable is crimped onto the provided ring terminal which is then fastened to the clamp at the end of the set screw. The clamp can be used with galvanized or stainless steel cable with a maximum diameter of 1/8 inch. (Cable is not included.) The BSDCCEE has a galvanized steel body and includes the ring terminal, and stainless steel hardware. (Winged Cup Point Set Screw and Dog Point Set Screw.)



Catalog Number: **BSDCCEE**

Features & Benefits

- Easy to install
- Galvanized steel body and stainless steel hardware
- Designed for clamping cable end to containers

Type GCB63T13G1 STUDBUG™ for Static Grounding Applications

GCB63T13G1 is a temporary grounding stud for use on rail cars, chemical trucks, hazardous waste tankers or a petroleum vehicle to allow for static grounding protection, while in operation. It provides a contact point, allowing the rail car, truck or tanker to be grounded to an equipotential grid or ground rod, by using static reel or a ground cable.

Catalog Number: **GCB63T13G1**

Features & Benefits

- Made of bronze; supplied with silicon bronze hardware
- Secured by 1/2" hexagonal nut and split lockwasher
- Can be used with universal clamps and ball stud clamps
- Can be used at various angles to reach inaccessible areas
- Add suffix "SS" for grounding stud with stainless steel hardware

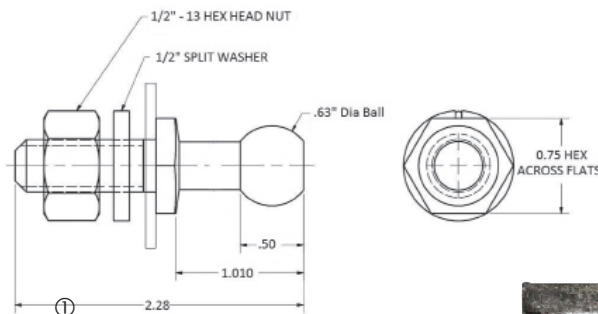

Note:

- ① Can be used with plate, bus bar or structural steel up to 1/4" thick.



Type GSC75

All-in-one Ball and Socket Design with NEMA Pad

Grounding studs provide a low resistance path in the event of a fault. The GSC75 series of studs are available in straight, 45°, and 90° variations with other angles available upon request. The GSC7530BCOVER provides a snug fit over the GSC75 studs when not in use to serve as an animal mitigation.

Features & Benefits

- High amperage rating
- Critter guard/cover available
- Available in Straight, 45°, and 90° variations
- Ball and Socket design accommodates industry standard clamps
- All-in-one design with NEMA terminal pad in-line with stud
- GSC752N30B5H is 5H Tested and Rated with third party laboratory test results available

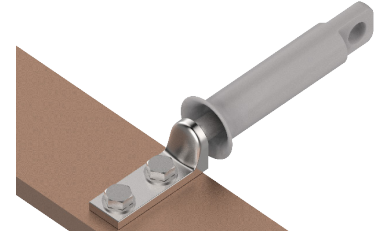
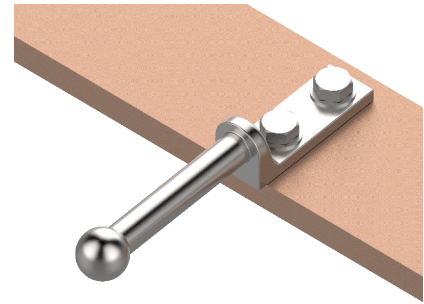
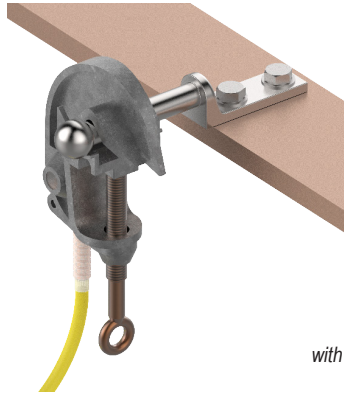

GSC752N30B
with GSC7530BCOVER

Catalog Number	Description	Hole Information	Pad Angle	Ball Diameter	Rating
GSC752N30B5H	Ground Stud (Straight)	1/2" holes with 1.75" spacing	straight	30 mm (1.18")	Grade 5H
GSC752N30B	Ground Stud (Straight)		straight	30 mm (1.18")	—
GSC752N30B45	Ground Stud (45°)		45 degree	30 mm (1.18")	—
GSC752N30B90	Ground Stud (90°)		90 degree	30 mm (1.18")	—
GSC7530BCOVER	Ground Stud Cover	—	—	—	—

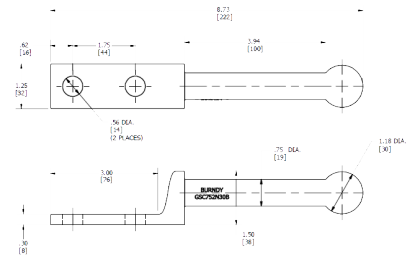

Type GSC63

Ground Ball Stud with 90° NEMA Pad

Tin-plated cast copper alloy ground stud incorporates an offset pad featuring NEMA spacing and 1" ball stud. Used when servicing a pad mounted transformer, the GSC63 series and optional orange thermoplastic elastomer cover provide for safe maintenance of equipment for optimal uptime.

Features & Benefits

Stud

- 90° offset pad
- NEMA Spacing
- Cast Copper Alloy
- Tin-plated for corrosion resistance
- GSC632NH25B5H is 5H Tested and Rated with third party laboratory test results available

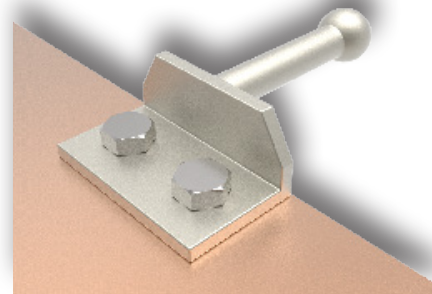
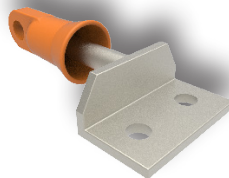

Cover

- Eye stem tool loop for install/removal
- Orange thermoplastic elastomer material

Catalog Number	Description	Hole Spacing	Pad Angle	Ball Diameter	Rating
GSC632NH1B	Ground stud with offset NEMA spacing pad	1.75"	90°	1" (25.4mm)	—
GSC632NH25B5H	Ground stud with offset NEMA spacing pad	1.75"	90°	1" (25.4mm)	Grade 5H
GSC632NH1BCOVER1	Thermoplastic elastomer cover (orange)	Not applicable for cover			—

Type GC-CT Cable Tray Ground Clamp

This unique connector incorporates features which are unmatched. Made of tin-plated cast copper alloy, it accommodates either one or two conductors, copper or aluminum cable. In addition to a low profile head with a deep Phillips recess, the galvanized steel bolt has a ribbed neck which prevents rotation during installation when installed in a 0.44 diameter hole.

- Rated for Direct Burial in earth or concrete
- UL467 Listed for the US and Canadian Markets with copper conductor only
- For aluminum conductor, the cable must be scratch brushed and PENETROX™ A joint compound must be applied on the cable and connector

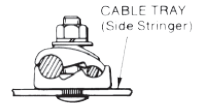
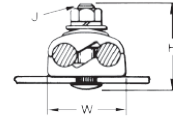
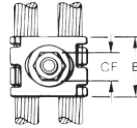

NOTE:

The bolt head is mounted on the inside wall of cable tray to avoid damage to the cable insulation. May be used with aluminum or galvanized steel cabletray.

Catalog Number	Accommodates Copper or Aluminum Conductor in either groove	B	CF	H	J	W
GC2525CT	#6 Sol. (0.16 Dia.) - 1/0 Str. (0.37 Dia.)	1.12	0.56	1.95	3/8	1.45
GC2626CT	#2 Sol. (0.26 Dia.) - 2/0 Str. (0.42 Dia.)	1.12	0.56	1.95	3/8	1.70
GC2929CT	2/0 Str. (0.41 Dia.) - 250 kcmil (0.58 Dia.)	1.12	0.56	2.20	3/8	1.98
GC3434CT	300 kcmil (0.63 Dia.) - 500 kcmil (0.81 Dia.)	2.00	0.75	3.31	1/2	2.48

Types BTCGC, BTCGC-SS Cu/Al Conductor to Al/Steel Cable Tray*; Al Solar PV Module Frames/Galvanized Steel Purlin

Made of aluminum and tin plated, the BTCGC and BTCGC-SS cable tray clamps accommodate aluminum or copper conductor #14 AWG through 250 kcmil. SS version is suitable for outdoor applications. The BTCGC clamp may be used with most types of cable tray with an inside or outside flange design.

Quick and easy installation requiring no drilling or special tools; use with 1/2" maximum straight rail, aluminum and steel cable trays. Tin plated for durability and corrosion resistance.

Features & Benefits



- Tin plated aluminum for durable, long lasting corrosion resistance
- UL2703 Listed for solar applications within the US and Canadian Markets*

NEW!!



- UL467 Listed for the US and Canadian Markets*
- Accommodates most common styles of cable tray with inside or outside flange
- Quick and easy installation; no drilling or special tools required
- Set screw bonds clamp to the cable tray while another set screw securely fastens the grounding conductor to the clamp providing vibration resistance and outstanding pull-out values
- Grounding green hardware†
- BTCGC4SS UL 2703 approved for Solar PV Module Frames up to 1/4" thick

Catalog Number	Copper or Aluminum Conductor	Max. Flange Thickness	L	W	H	Inst. Tooling	Rec. Inst. Torque (in-lb)		UL Surface Compatibility			
							Cable	Flange	AL Cable Tray	Steel Cable Tray	Anodized AL	Galv. Steel
BTCGC4SS	#14 AWG - #4 AWG	1/4" Max	1.35	0.50	1.30	7/16" Hex	30	50	Y	Y	Y	Y
BTCGC1/0SS	#12 AWG - 1/0 kcmil	3/8" Max	1.60	0.75	1.55	9/16" Hex	100	150	Y	Y	N	Y
BTCGC250SS*	#6 AWG - 250 kcmil	1/2" Max	2.25	0.88	2.43	1/4" Hex Key	225	150	Y	N	N	Y
BTCGC250*†	#6 AWG - 250 kcmil	1/2" Max	2.25	0.88	2.43	1/4" Hex Key	225	150	Y	N	N	Y

*BTCGC250 and BTCGC250SS are not UL Listed to steel cable tray.

†BTCGC250 does not have grounding green hardware

Type GXP1828RF SUPER-CLAMP™ Raised Floor / Rebar / Fence Post Ground Connector

Raised Floor Pedestal / Rebar / Fence Post Ground Connector. The GXP1828RF is a versatile, easy to install, range taking ground connector. This grounding clamp accepts a wide range of pedestals and conductors. Accepted pedestal / fence post range is 3/4" through 2" (7/8 - 2" round; 3/4" - 1-1/2" square). The wire range is #6 solid to 4/0 stranded. The wires can be arranged in a parallel or cross grid configuration - accepts 1 or 2 wires.

The high copper alloy body ensures excellent conductivity and the hardware is made of stainless steel. The connector is rated for Direct Burial in earth or concrete and UL467 Listed for the US and Canadian Markets. The versatility of the connector makes it an excellent choice for applications requiring multiple conductor sizes and/or configurations.

Features & Benefits

- Fits a wide range of raised floor pedestals / fence posts, from 3/4" to 2" (7/8" to 2" round; 3/4" to 1-1/2" square)
- Accepts a wide range of wire sizes, #6 solid to 4/0 stranded
- Can be used for rebar sizes ranged from #7 to #12 size (7/8" to 1-1/2" dia.)
- Accommodates parallel wires or cross grid arrangements; wires can be installed in cross grid configuration
- Accepts one or two wires in any configuration
- Easy to install open design eliminates the need to disassemble before installing
- One socket size fits all hardware (1/2" socket size)
- Made of high copper alloy with stainless steel hardware
- UL467 Listed for the US and Canadian Markets
- Rated for Direct Burial in earth or concrete

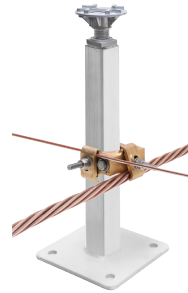
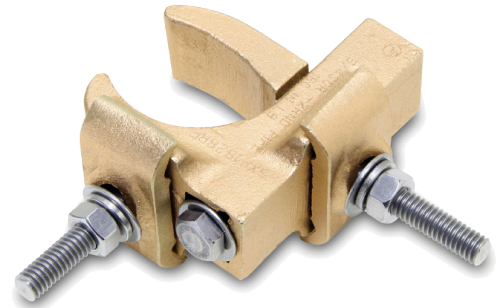

Cross Grid Configuration

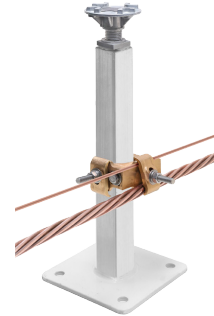

Parallel Configuration

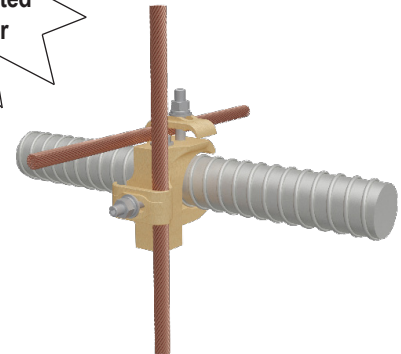

Rebar Connection

1/2" Cross Flat

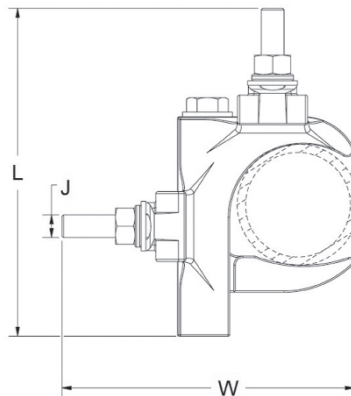
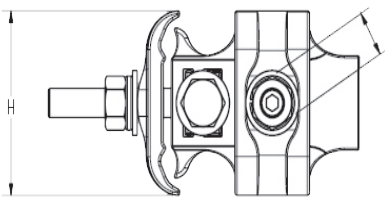

Catalog Number	Copper Conductor Range (Concentric & Compact Stranded 19 Str. Max)	Pedestal / Fence Post Range	Rebar	Reference Dimensions				Recommended Tightening Torque (in-lb.)	
				L	W	H	J	Conductor Saddle (Nut)	Pedestal Clamp or Rebar (Bolt)
GXP1828RF	6 AWG - 4/0 AWG	Round: 7/8" - 2" Square: 3/4" - 1-1/2"	Rebar Size: 7/8" - 1-1/2" (#7 - #12)	4.53	3.94	1.96	5/16	120	180

Type GRF UNIGROUND™
Raised Floor Grounding Connector

The BURNDY® UNIGROUND™ is a universal grounding clamp, specifically designed for all raised flooring systems. It can be installed on round or square pedestals and can accommodate one or two grounding wires to make an efficient grid. The underfloor signal reference grid provides the low impedance ground path that attenuates high frequency static and 60 Hz transient noise for cleaner data output. UL467 Listed.

Features & Benefits

- One connector fits all applications
- Ease of specification and installation
- Single bolt design with no need to disassemble
- Single wrench installation
- Accepts 1 or 2 ground conductors
- Requires less connectors to install signal reference grid
- Tin plated cast bronze construction
- Resists corrosion and provides extended life ground connection
- Grounds all pedestals (round or square); will accept up to 7/8" square and up to 1" round
- Serves 3 needs: Signal Reference Grid, Static Ground, and Fault Current Ground
- UNIGROUND™ connector will solve all grounding problems found in computer applications today
- UL467 Listed for the US and Canadian Markets

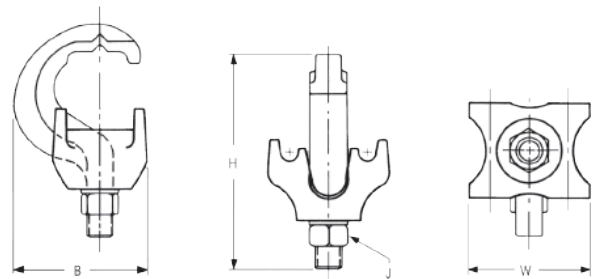

Catalog Number	Number of Conductors	Conductor Size Sol. & Str.	Pedestal Type		B	H	J	W
			Round	Square				
GRF4C-3	1 or 2	#8 - #2	Up to 1"	Up to 7/8"	1.96	3.14	3/8	1.76
GRF4C-4	1 or 2	#8 - #2	Up to 3/4"	Up to 5/8"	1.79	3.13	3/8	1.40

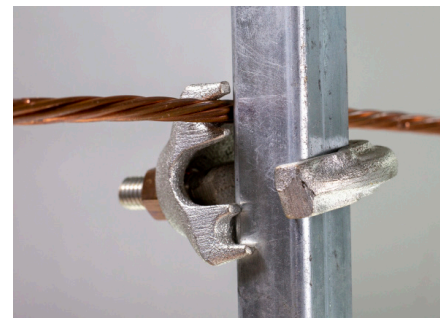
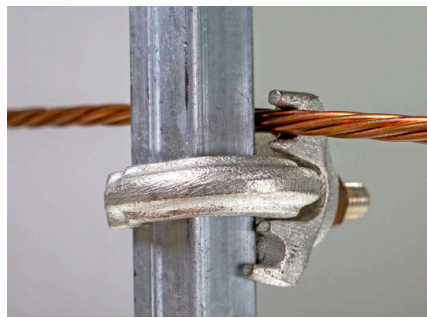

Types GP-G1, GP-RT Raised Floor Grounding Clamps

High copper alloy ground connector for raised floor computer grounding applications. These connectors can be installed on round and square pedestal applications and will accommodate one or two grounding wires to make an efficient grid. The underfloor signal reference grid provides the low impedance ground path that attenuates high frequency static and 60 Hz transient noise for cleaner data output. UL467 Listed.

In addition we offer the GP1726RT, which is specifically designed for penetrating epoxy paint on pedestals. This patented connector offers a low impedance, time saving connection between conductors and the pedestal.

Features & Benefits



- Accepts 1 or 2 ground conductors
- Requires less connectors to install signal reference grid
- Made of copper alloy
- DURIMUM™ Silicon Bronze U-Bolts, nuts and lockwashers
- Provides a low impedance ground path for maximum performance
- Grounds all pedestals (round or square)
- Accepts from 3/4" to 1" round or square
- Ease of installation
- Serves 3 needs: Signal Reference Grid, Static Ground, and Fault Current Ground
- Connectors solve all possible grounding problems found in computer applications today
- UL467 Listed for the US and Canadian Markets

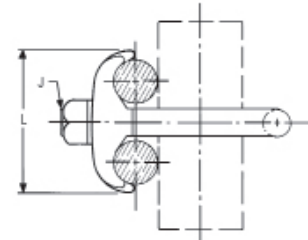
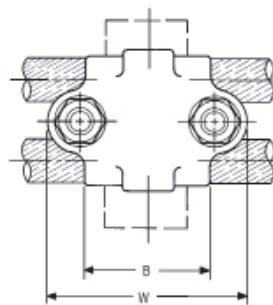
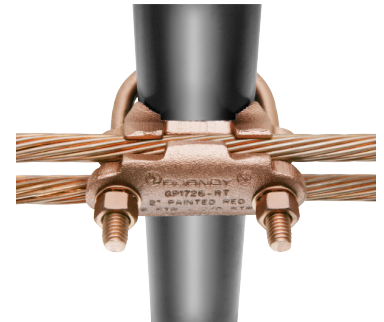
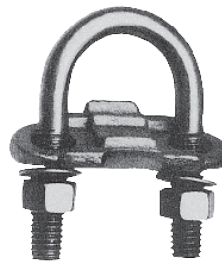

Catalog Number	Number of Conductors	Conductor Size Sol. & Str.	Pedestal Size/ Type	B	J	L	W
GP654CG1	1 or 2	#8 Sol. - 4 Str.	3/4" - 1" Round 3/4" - 7/8" Square	1.50	3/8	1.31	2.38
GP64526G1	1 or 2	#4 Sol. - 2/0 Str.		1.50	3/8	1.69	2.38
GP64528G1	1 or 2	#4 Sol. - 4/0 Str.		1.50	3/8	1.69	2.38
GP1526G1	1 or 2	#4 Sol. - 2/0 Str.	1-1/4" Round	1.75	3/8	1.69	2.62
GP1726RT	1 or 2	#6 Sol. - 2/0 Str.	2" Round	2.12	3/8	1.50	3.22
GP1726G1	1 or 2	#6 Sol. - 2/0 Str.	2" Round	2.12	3/8	1.50	3.22

Flexible Copper Braid Jumper

Copper braid is made of tinned, pure copper wire woven and flattened into a rectangular shape for greater flexibility. Seamless, pure copper ferrules are formed and assembled on each end to provide appropriate contact surfaces.

Braid is used extensively to compensate for expansion and contraction of moving parts and for thermal movement of rigid devices; to prevent breakage of insulators or bushings or equipment because of misalignment during settling of substation foundations; to absorb shock and vibration of operating equipment; and to provide flexible current carrying leads between moving parts of heavy machinery or equipment.

Current Carrying Capacity

Flexible copper braid has generally better heat dissipation properties than flat bar, cable or other conductors, and therefore can be expected to have a greater current carrying capacity for given cross-sectional area. This is due to its greater surface area resulting from the woven construction of fine strands. However, ventilation, due to the vertical convection current of air, is appreciably better when the long axis of the braid is vertical rather than horizontal, so that the long sides of the braid, rather than the edges, are exposed to the moving air. This is particularly true when spaced braids are used in multiple as can be seen by comparing Figure 1 and 2.

To take full advantage of ventilation, the cooling convection current of air should be permitted to flow freely between the braids. Therefore, if possible, the braids should be spaced apart, rather than bunched together, as illustrated in Figure 3. The effectiveness of spacing is, of course, greater when the braids are in a vertical position.

Bulk Braid

Bulk braid can be ordered with a minimum order quantity of 10 feet. Specify feet in number of inches.

Example: 10 feet of 190 ampere braid is Catalog No. BB077L120.

INDOOR RATING AMPS	EQUIV CIRCULAR AREA	CAT NO.	APPROX WEIGHT PER FT
75	24,000	BB024L	0.06
95	48,000	BB048L	0.16
110	67,000	BB067L	0.22
190	77,184	BB077L	0.24
340	153,700	BB154L	0.49
360	231,552	BB226L	0.76
415	300,000	BB300L	1.06

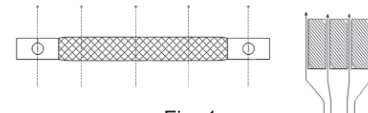

Fig. 1
Conventional current have maximum cooling effect with Braid in vertical position.

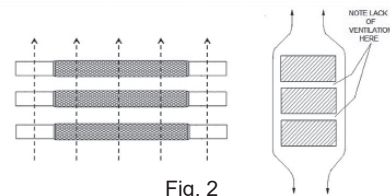
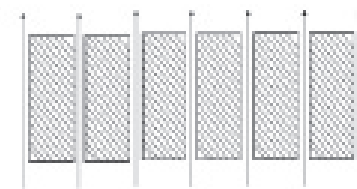
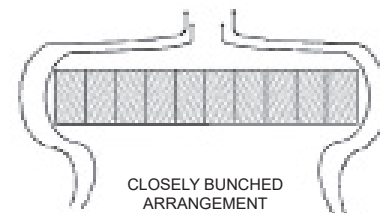

Fig. 2
Ventilation less efficient with Braid in horizontal position



OPEN ARRANGEMENT
Cooling due to convection current much more effective with spaced Braid

Fig. 3

Flexible Copper Braid Custom Designs

Flexible copper braid offers an economical and efficient means of protecting electrical equipment from the potentially harmful effects of shock and vibration, terminal expansion, movement of components and misalignment that may occur during the service life of the equipment.

Many varieties of braid are required to meet those needs which we can build to your specifications.

We also offer engineering assistance in the selection of the most appropriate standard or custom braid configuration for your application.

Custom Variations

Drilling

- * Undrilled
- * Elongated (slotted) holes
- * Special hole patterns and location
- * Metric
- * NEMA

Plating

- * Tin
- * Silver
- * Nickel
- * Unplated

Length

- * Jumper (overall)
- * Ferrule(s) contact

Insulated (covered)

- * Tubular
- * Heat shrink

Split Braid Assemblies

- * Stacked
- * Side-by-side

Multiple Ferrules

Preformed Configurations

- * Offset contact surfaces
- * Angular (e.g. 90°, 180°) bends
- * Ferrule contact surfaces rotated 90° on braid axis

Combined Braid Assemblies

Combined connector - Braid Assemblies

Ferrule Variations

- * Belled/unbelled
- * Width/thickness
- * Contact length
- * Special shaping
- * Bent at angle°

High Ampacity Requirements

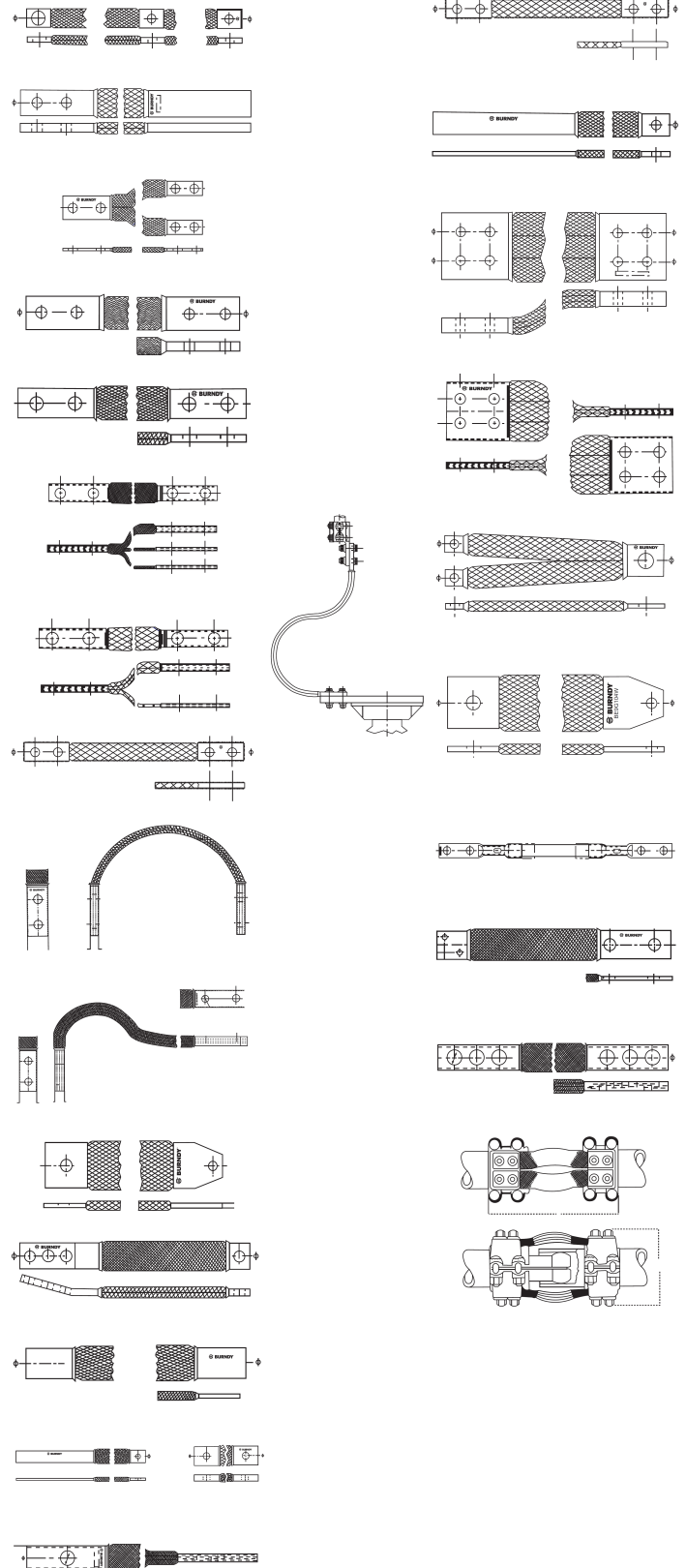

Type B
1-Hole Ferrule End

Flexible copper braid jumpers designed to take up linear expansion and contraction, compensate for misalignment and absorb vibratory movement of electrical equipment and devices. Made of flat extra flexible tinned pure copper braid with high quality BURNDY ferrules on each end. Other lengths, plating and connector sizes are available; contact BURNDY for more information.



Catalog Number	AWG Equivalent	Length (inches)	End Type	Stud Hole	Approximate Ampere Rating	
					Indoor	Outdoor
BB024L6T14*	#6 AWG	6.00	Ferrule	1/4	75	100
BB024L9T14*	#6 AWG	9.00	Ferrule	1/4	75	100
BB036L9T14*	#5 AWG	9.00	Ferrule	1/4	85	125
BB036L12T14*	#5 AWG	12.00	Ferrule	1/4	85	125
BB036L18T14*	#5 AWG	18.00	Ferrule	1/4	85	125
BB048L6T14*	#4 AWG	6.00	Ferrule	1/4	95	150
BB048L9T14*	#4 AWG	9.00	Ferrule	1/4	95	150
BB067L6T14	#2 AWG	6.00	Ferrule	1/4	110	180
BB067L9T14	#2 AWG	9.00	Ferrule	1/4	110	180
BD6T14	#1 AWG	6.00	Ferrule	1/4	190	225
BD9T14	#1 AWG	9.00	Ferrule	1/4	190	225
BE12T716	3/0 AWG	12.00	Ferrule	7/16	340	405
BE18T716	3/0 AWG	18.00	Ferrule	7/16	340	405
BE12T58	3/0 AWG	12.00	Ferrule	5/8	340	405
BE18T58	3/0 AWG	18.00	Ferrule	5/8	340	405
BE24T58	3/0 AWG	24.00	Ferrule	5/8	340	405
BE6T716	3/0 AWG	6.00	Ferrule	7/16	340	405
BF6T716	4/0 AWG	6.00	Ferrule	7/16	360	430
BF12T716	4/0 AWG	12.00	Ferrule	7/16	360	430
BF18T716	4/0 AWG	18.00	Ferrule	7/16	360	430
BG6T716	300 kcmil	6.00	Ferrule	7/16	415	495
BG8T716	300 kcmil	8.00	Ferrule	7/16	415	495
BG12T716	300 kcmil	12.00	Ferrule	7/16	415	495
BG12T12	300 kcmil	12.00	Ferrule	1/2	415	495

* Not CSA Certified

Type B 2-Hole Ferrule End

Flexible copper braid jumpers designed to take up linear expansion and contraction, compensate for misalignment and absorb vibratory movement of electrical equipment and devices.

Made of flat extra flexible, tinned, pure copper braid, with unplated, seamless, pure copper ferrules formed into a rectangular shape on each end.

Last two numbers in catalog number indicate total length of braid in inches (e.g., BD12N or BD12 is 12" long braid jumper).

Other lengths, plating and drilling are available. Contact the factory.

Catalog # Prefix	Equiv. AWG Size
BD	#1
BE	3/0
BF	4/0
BG	300 kcmil

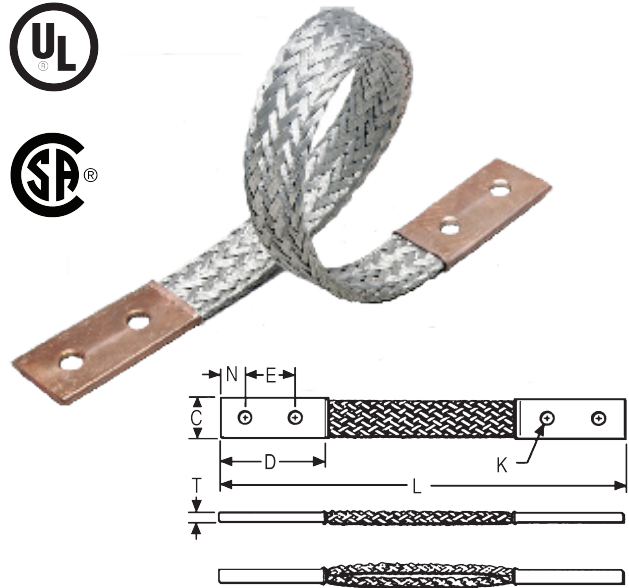

Catalog Number	Number of Braids in Ferrules	C	D	E	K	L	N	T	Approximate Ampere Rating	
									Indoor	Outdoor
BD12 ②	1	0.94	2.50	1.25	0.44	12	0.62	0.13	190	225
BD12N ②	1	0.94	3.00	1.75	0.56	12	0.62	0.13	190	225
BD18 ②	1	0.94	2.50	1.25	0.44	18	0.62	0.13	190	225
BD18N ②	1	0.94	3.00	1.75	0.56	18	0.62	0.13	190	225
BD24 ②	1	0.94	2.50	1.25	0.44	24	0.62	0.13	190	225
BD24N ②	1	0.94	3.00	1.75	0.56	24	0.62	0.13	190	225
BE12 ②	1	1.50	3.00	1.50	0.44	12	0.75	0.17	340	405
BE12N ②	1	1.50	3.00	1.75	0.56	12	0.62	0.17	340	405
BE18 ②	1	1.50	3.00	1.50	0.44	18	0.75	0.17	340	405
BE18N ②	1	1.50	3.00	1.75	0.56	18	0.62	0.17	340	405
BE24 ②	1	1.50	3.00	1.50	0.44	24	0.75	0.25	340	405
BE24N ②	1	1.50	3.00	1.75	0.56	24	0.62	0.17	340	405
BF12 ②	1	1.19	3.00	1.50	0.44	12	0.75	0.25	360	430
BF12N ②	1	1.19	3.00	1.75	0.55	12	0.62	0.25	360	430
BF18 ②	1	1.19	3.00	1.50	0.44	18	0.75	0.25	360	430
BF18N ②	1	1.19	3.00	1.50	0.44	18	0.75	0.25	360	430
BF24 ②	1	1.19	3.00	1.50	0.44	24	0.75	0.25	360	430
BF24N ②	1	1.19	3.00	1.75	0.56	24	0.62	0.25	360	430
BG12	1	1.50	3.00	1.50	0.44	12	0.75	0.25	415	495
BG12N ①	1	1.50	3.00	1.75	0.56	12	0.62	0.25	415	495
BG18	1	1.50	3.00	1.50	0.44	18	0.75	0.25	415	495
BG18N ①	1	1.50	3.00	1.75	0.56	18	0.62	0.25	415	495
BG24	1	1.50	3.00	1.50	0.44	24	0.75	0.25	415	495
BG24N ①	1	1.50	3.00	1.75	0.56	24	0.62	0.25	415	495

① Tongue drilled per (2) hole NEMA Standard

② Certified to CSA C22.2, No. 41 Grounding and Bonding Equipment Standards in addition to the UL467 Listing which all items above are Listed to.

NOTE: Equivalent sizes may be designated by suffix letters representing variations in length, mounting configurations, pad size and finish. Contact factory for details. For Tin plated ferrules add suffix -TN to the catalog number.

Type B (Continued)



Catalog Number	Number of Braids in Ferrules	C	D	E	K	L	N	T	Approximate Ampere Rating	
									Indoor	Outdoor
B2D12 ②	2	0.94	2.5	1.25	0.44	12	0.62	0.25	380	455
B2D12N ②	2	0.94	3.00	1.75	0.56	12	0.62	0.25	380	455
B2E12	2	1.62	3.00	1.50	0.44	12	0.75	0.25	530	635
B2E12N ①	2	1.62	3.00	1.75	0.56	12	0.62	0.25	530	635
B2F12	2	1.38	3.00	1.50	0.44	12	0.75	0.38	600	720
B2F12N ①	2	1.38	3.00	1.75	0.56	12	0.62	0.38	600	720
B2G12N ①	2	1.50	3.00	1.75	0.56	12	0.62	0.50	700	840
B3D12	3	1.19	2.50	1.25	0.44	12	0.62	0.25	470	560
B3D12N ②	3	1.19	3.00	1.75	0.56	12	0.62	0.25	470	560
B3E12	3	1.64	3.00	1.50	0.44	12	0.75	0.31	700	840
B3E12N ①	3	1.64	3.00	1.75	0.56	12	0.62	0.31	700	840
B3F12	3	1.44	3.00	1.50	0.44	12	0.75	0.56	820	980
B3F12N ①	3	1.44	3.00	1.75	0.56	12	0.62	0.56	820	980
B3G12	3	1.69	3.00	1.50	0.44	12	0.75	0.69	960	1150
B3G12N ①	3	1.69	3.00	1.75	0.56	12	0.62	0.69	960	1150
B4D12	4	1.19	2.50	1.25	0.44	12	0.62	0.32	600	720
B4D12N ①	4	1.19	3.00	1.75	0.56	12	0.62	0.32	600	720
B4E12	4	1.64	3.00	1.50	0.44	12	0.75	0.38	850	1020
B4E12N ①	4	1.64	3.00	1.75	0.56	12	0.62	0.38	850	1020
B4F12	4	1.50	3.00	1.50	0.44	12	0.75	0.78	1000	1200
B4F12N ①	4	1.50	3.00	1.75	0.56	12	0.62	0.78	1000	1200
B4G12N ①	4	1.69	3.00	1.75	0.56	12	0.62	0.94	1200	1440

① Tongue drilled per (2) hole NEMA Standard

② Certified to CSA C22.2, No. 41 Grounding and Bonding Equipment Standards in addition to the UL467 Listing which all items above are Listed to.

NOTE:

Equivalent sizes may be designated by suffix letters representing variations in length, mounting configurations, pad size and finish. Contact factory for details. For Tin plated ferrules add suffix -TN to the catalog number.

Type BB-ML-TN 1-Hole Ferrule End

One-hole extra flexible grounding and bonding braids are designed of flat tinned copper braid with a seamless tin-plated copper ferrule. Each ferrule is pressed into a solid mass to prevent moisture build up inside the connection to help mitigate corrosion issues seen in typical wire and lug jumpers. Additionally, the seamless copper ferrule end prevents fraying and provides extra strength for a robust bonding connection. Burndy one-hole grounding and bonding braids are a convenient solution for a long-lasting connection and are ideal in applications that require flexibility or resistance to vibration.



Features & Benefits

- cULus Listed to UL 467 and CSA22.2 N0. 41 for grounding and bonding
- Electro-tinned copper braids and ferrules for superior corrosion resistance
- Pressed seamless copper ferrules for added durability at the connection point
- Extra fine stranding provides enhanced flexibility
- Convenient single bolt installation
- Ready to install out of the box, no cutting or crimping required
- Ferrules clearly marked with BURNDY braid type and UL markings
- Available in custom lengths and holes sizes to suit all applications*

* Contact your local sales representative for custom lengths or hole sizes

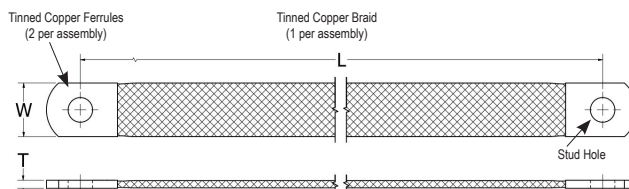

For applications that require a flexible braid that is not listed in the catalog use the convention below:

BB099M L12 T38 TN
1 2 3 4

1. Braid size, refer to **Table 1**.
2. Braid length, in inches (Dimension L); for lengths that require a decimal place use "D" in place of the decimal (ex. 12D50 = 12.5 inches).
3. Stud Size, refer to **Table 2**.
4. Plating type, refer to **Table 3**.

Catalog Number	Braid Size			Dimensions (inches)			
	Approx. AWG	kcmil	Metric	W	T	Stud Size	L
BB019ML6T14TN	8	19	10mm ²	0.39	0.08	1/4	6
BB019ML9T14TN							9
BB019ML12T14TN							12
BB019ML18T14TN							18
BB019ML24T14TN							24
BB031ML6T14TN	6	31	16mm ²	0.59	0.09	1/4	6
BB031ML9T14TN							9
BB031ML12T14TN							12
BB031ML18T14TN							18
BB031ML24T14TN							24
BB031ML6T38TN	6	31	16mm ²	0.59	0.09	3/8	6
BB031ML9T38TN							9
BB031ML12T38TN							12
BB031ML18T38TN							18
BB031ML24T38TN							24
BB049ML6T14TN	4	49	25mm ²	0.91	0.13	1/4	6
BB049ML9T14TN							9
BB049ML12T14TN							12
BB049ML18T14TN							18
BB049ML24T14TN							24

See next page for additional standard sizes

Braid Size Identifier	Cross Section		
	Approx. AWG	kcmil	mm ²
BB019M	8	19	10
BB031M	6	31	16
BB049M	4	45	25
BB059M	3	59	30
BB069M	2	69	35
BB099M	1	99	50
BB139M	2/0	139	70
BB197M	3/0	197	100

Table 1

Stud Size Identifier	Stud Size
T10	#10
T14	1/4"
T516	5/16"
T38	3/8"
T716	7/16"
T12	1/2"
T58	5/8"
T34	3/4"

Table 2

Plating Identifier	Plating Type
TN	Electro-Tin
W	Tin Dip
NK	Nickel
SV	Silver

Table 3

To order a custom braid please contact your local sales representative

Type BB-ML-TN (Continued)



Catalog Number	Braid Size			Dimensions (inches)			
	Approx. AWG	kcml	Metric	W	T	Stud Size	L
BB049ML6T38TN	4	49	25mm ²	0.91	0.13	3/8	6
BB049ML9T38TN							9
BB049ML12T38TN							12
BB049ML18T38TN							18
BB049ML24T38TN							24
BB059ML6T38TN	3	59	30mm ²	0.91	0.13	3/8	6
BB059ML9T38TN							9
BB059ML12T38TN							12
BB059ML18T38TN							18
BB059ML24T38TN							24
BB069ML6T38TN	2	69	35mm ²	0.91	0.13	3/8	6
BB069ML9T38TN							9
BB069ML12T38TN							12
BB069ML18T38TN							18
BB069ML24T38TN							24
BB099ML6T38TN	1	99	50mm ²	1.10	0.14	3/8	6
BB099ML9T38TN							9
BB099ML12T38TN							12
BB099ML18T38TN							18
BB099ML24T38TN							24
BB099ML9T12TN	1	99	50mm ²	1.10	0.14	1/2	9
BB099ML12T12TN							12
BB099ML18T12TN							18
BB099ML24T12TN							24
BB139ML12T38TN							2/0
BB139ML18T38TN	18						
BB139ML24T38TN	24						
BB139ML12T12TN	2/0	139	70mm ²	1.18	0.16	1/2	12
BB139ML18T12TN							18
BB139ML24T12TN							24
BB197ML12T38TN	3/0	197	100mm ²	1.57	0.19	3/8	12
BB197ML18T38TN							18
BB197ML24T38TN							24
BB197ML12T12TN	3/0	197	100mm ²	1.57	0.19	1/2	12
BB197ML18T12TN							18
BB197ML24T12TN							24

Type BB-LT 1-Hole Connector End

Flexible copper braid jumpers designed to take up linear expansion and contraction, compensate for misalignment and absorb vibratory movement of electrical equipment and devices. Made of flat extra flexible tinned pure copper braid with high quality BURNDY tin plated connectors on each end. Other lengths, plating and connector sizes are available; contact BURNDY for more information.



Catalog Number	AWG Equivalent	Length (inches)	End Type	Stud Hole
BB024L8LT14	#6 AWG	8.00	Connector	1/4
BB024L12LT14	#6 AWG	12.00	Connector	1/4
BB024L18LT14	#6 AWG	18.00	Connector	1/4
BB024L24LT14	#6 AWG	24.00	Connector	1/4
BB048L12LT14	#4 AWG	12.00	Connector	1/4
BB048L18LT14	#4 AWG	18.00	Connector	1/4
BB048L24LT14	#4 AWG	24.00	Connector	1/4
BB048L12LT38	#4 AWG	12.00	Connector	3/8
BB048L18LT38	#4 AWG	18.00	Connector	3/8
BB048L24LT38	#4 AWG	24.00	Connector	3/8
BB048L12LT12	#4 AWG	12.00	Connector	1/2
BB048L18LT12	#4 AWG	18.00	Connector	1/2
BB048L24LT12	#4 AWG	24.00	Connector	1/2

Types CCY, B-B
Covered Jumpers

Insulated flexible copper braid jumpers designed to take up linear expansion and contraction, compensate for misalignment and absorb vibratory movement of electrical equipment and devices. Made of extra flexible tinned pure copper braid with high quality BURNDY tin plated connectors or ferrules on each end. Other lengths, plating, insulation colors and connector sizes are available; contact BURNDY for more information.

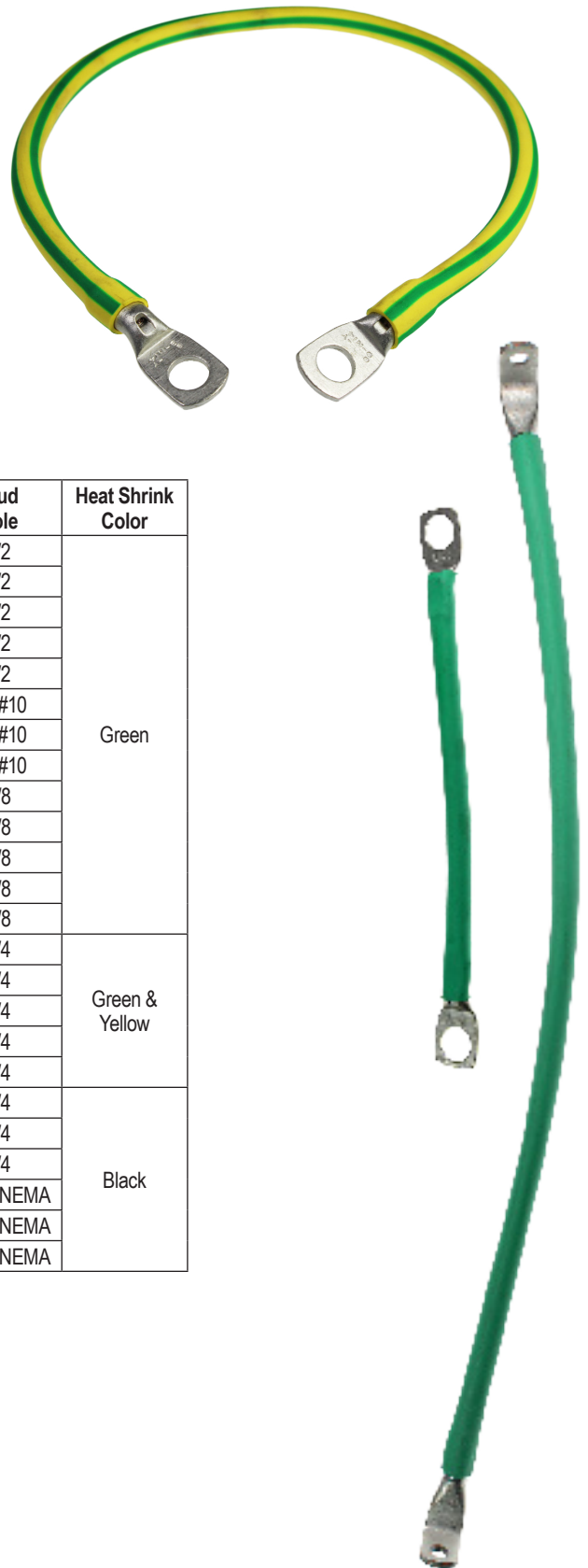

Catalog Number	AWG Equivalent	Length (inches)	End Type	Stud Hole	Heat Shrink Color			
CCY106LT12G	#10 AWG	6.00	Connector	1/2	Green			
CCY10L9T12G		9.00		1/2				
CCY10L12T12G		12.00		1/2				
CCY10L18T12G		18.00		1/2				
CCY10L24T12G		24.00		1/2				
CCY10L12LT1090G		12.00		#8-#10				
CCY10L18LT1090G		18.00		#8-#10				
CCY10L24LT1090G		24.00		#8-#10				
CCY10L6LT38G		6.00		3/8				
CCY10L9LT38G		9.00		3/8				
CCY10L12LT38G		12.00		3/8				
CCY10L18LT38G		18.00		3/8				
CCY10L24LT38G		24.00		3/8				
CCY10L7T14GY		#10 AWG		7.00		Connector	1/4	Green & Yellow
CCY10L9T14GY				9.00			1/4	
CCY10L12LT14GY				12.00			1/4	
CCY10L14LT14GY	14.00		1/4					
CCY10L18LT14GY	18.00		1/4					
BB024L12LT14B	#6 AWG	12.00	Connector	1/4	Black			
BB024L18LT14B		18.00		1/4				
BB024L24LT14B		24.00		1/4				
BD12NB	#1 AWG	12.00	Ferrule	2 hole NEMA				
BD18NB		18.00		2 hole NEMA				
BD24NB		24.00		2 hole NEMA				

Type BB-SS Stainless Steel Braid

Flexible stainless steel braid jumpers designed to take up linear expansion and contraction, compensate for misalignment and absorb vibratory movement of electrical equipment and devices. Made of flat extra flexible stainless steel braid with high quality BURNDY tin plated connectors or ferrules on each end. Other lengths, plating and connector sizes are available; contact BURNDY for more information.



Catalog Number	AWG Equivalent	Length (inches)	End Type	Stud Hole
BB024SSL6LT516	#6 AWG	6.00	Connector	5/16
BB024SSL9LT516		9.00		5/16
BB024SSL12LT516		12.00		5/16
BB024SSL6LT38		6.00		3/8
BB024SSL9LT38		9.00		3/8
BB024SSL12LT38		12.00		3/8
BB024SSL6LT14		6.00		1/4
BB024SSL9LT14		9.00		1/4
BB024SSL12LT14		12.00		1/4
BB024SSL6T14		6.00	Ferrule	1/4

Type B
Undrilled Ferrules

Undrilled seamless pure copper ferrules are supplied with scored lines and dimples. Scored lines locate the center of the ferrule and prevent the drill from walking when drilling in this area. Dimples at the end of the scored lines represent the location of the NEMA standard hole spacing. Drill the holes you need, where you need them, using the supplied guide and the cULus Listing is retained. BURNDY undrilled braids offer a field flexible solution for almost any application!

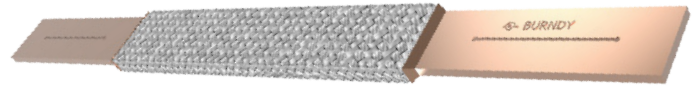

* Add TN to the end of catalog number for tinned ferrules

Features & Benefits

- cULus **before** drilling — cULus **after** drilling!
- Designed for unparallel field flexibility allowing custom ferrule drilling for specific applications while maintaining UL Listing
- Undrilled seamless pure copper ferrules supplied with scored lines and 'dimples' at the end representing the location of the NEMA standard hole spacing
- Scored lines locate the center of ferrule and prevent the drill from walking when drilling in this area
- Flexible copper braid jumpers take up linear expansion and contraction to compensate for movement of electrical equipment and devices

Catalog Number	AWG Equivalent	Length (inches)	Ferrule Width (inches)	Approximate Ampere Rating	
				Indoor	Outdoor
BD12N2U	#1 AWG	12"	.94	190	225
BD18N2U	#1 AWG	18"	.94	190	225
BD24N2U	#1 AWG	24"	.94	190	225
BD36N2U	#1 AWG	36"	.94	190	225
BE12N2U	3/0 AWG	12"	1.50	340	405
BE18N2U	3/0 AWG	18"	1.50	340	405
BE24N2U	3/0 AWG	24"	1.50	340	405
BE36N2U	3/0 AWG	36"	1.50	340	405
BF12N2U	4/0 AWG	12"	1.19	360	430
BF18N2U	4/0 AWG	18"	1.19	360	430
BF24N2U	4/0 AWG	24"	1.19	360	430
BF36N2U	4/0 AWG	36"	1.19	360	430
BG12N2U	300 kcmil	12"	1.50	415	495
BG18N2U	300 kcmil	18"	1.50	415	495
BG24N2U	300 kcmil	24"	1.50	415	495
BG36N2U	300 kcmil	36"	1.50	415	495

* Add TN to the end of catalog number for tin plated ferrules

Type B-4N, For use in Power Distribution Applications Braid with 4-hole NEMA Pad

Designed with a large cross sectional area and stacked layers of flexible braid material, these braids can accommodate high current applications. These braids are often found in substation applications, where they are used as a flexible connection between two rigid bus lengths. Braids are commonly used in applications where thermal expansion and contraction between rigid parts exist, components are misaligned, and in environments that have frequent vibration or shock.

Due to different stranding size and orientation, braid has been found to have a greater amperage rating when compared to typical conductors ratings set forth by the National Electric Code (NEC). The finer stranding in our braid, with more air pockets, allows for better heat dissipation with more surface area exposed to ambient air. Our ferrule-style braids offer a heavy duty contact area for more rigorous grounding and power applications.

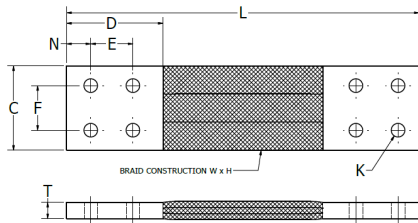
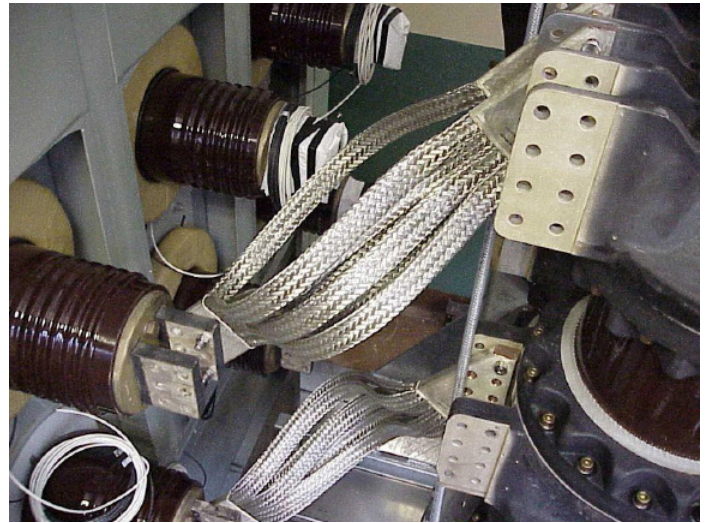

Catalog Number	L	C	D	E	F	K	T	N	Braid Construction (W X H)	Cross Sectional Area		Approx. Ampere Rating *		
										kcmil	mm ²	Δ 30°C	Δ 45°C	Δ 60°C
B22F184N	18	3	3	1.75	1.75	0.56	0.44	0.63	2 x 2	921	467	945	1135	1290
B22F244N	24													
B22F364N	36													
B22G184N	18	3	3	1.75	1.75	0.56	0.56	0.63	2 x 2	1228	622	1165	1400	1585
B22G244N	24													
B22G364N	36													
B23F184N	18	3	3	1.75	1.75	0.56	0.62	0.63	2 x 3	1382	700	1230	1475	1670
B23F244N	24													
B23F364N	36													
B23G184N	18	3	3	1.75	1.75	0.56	0.65	0.63	2 x 3	1843	934	1520	1825	2065
B23G244N	24													
B23G364N	36													
B24F184N	18	3	3	1.75	1.75	0.56	0.65	0.63	2 x 4	1843	934	1495	1795	2035
B24F244N	24													
B24F364N	36													
B24G184N	18	3	3	1.75	1.75	0.56	0.70	0.63	2 x 4	2457	1245	1865	2235	2530
B24G244N	24													
B24G364N	36													

*Approximate ampere ratings are calculated values based on a free air environment with a 30°C ambient temperature. These ratings are approximate and vary with ambient conditions, orientation of the braid, and other service conditions.

Add -TN suffix for tin-plated ferrules

All shown have pad drilled per 4-hole NEMA standard. Other lengths, pad sizes, hole patterns and finishes are available. Please contact the factory for details.

Type B-4N (Continued)

Catalog Number	L	C	D	E	F	K	T	N	Braid Construction (W X H)	Cross Sectional Area		Approx. Ampere Rating *		
										kcmil	mm ²	Δ 30°C	Δ 45°C	Δ 60°C
B32F184N	18	4	4	1.75	1.75	0.56	0.50	1.12	3 x 2	1382	700	1330	1595	1810
B32F244N	24													
B32F364N	36													
B32G184N	18	4	4	1.75	1.75	0.56	0.56	1.12	3 x 2	1843	934	1635	1965	2220
B32G244N	24													
B32G364N	36													
B33F184N	18	4	4	1.75	1.75	0.56	0.65	1.12	3 x 3	2073	1050	1720	2065	2335
B33F244N	24													
B33F364N	36													
B33G184N	18	4	4	1.75	1.75	0.56	0.87	1.12	3 x 3	2764	1401	2045	2455	2775
B33G244N	24													
B33G364N	36													

*Approximate ampere ratings are calculated values based on a free air environment with a 30°C ambient temperature. These ratings are approximate and vary with ambient conditions, orientation of the braid, and other service conditions.

Add -TN suffix for tin-plated ferrules

All shown have pad drilled per 4-hole NEMA standard. Other lengths, pad sizes, hole patterns and finishes are available. Please contact the factory for details.

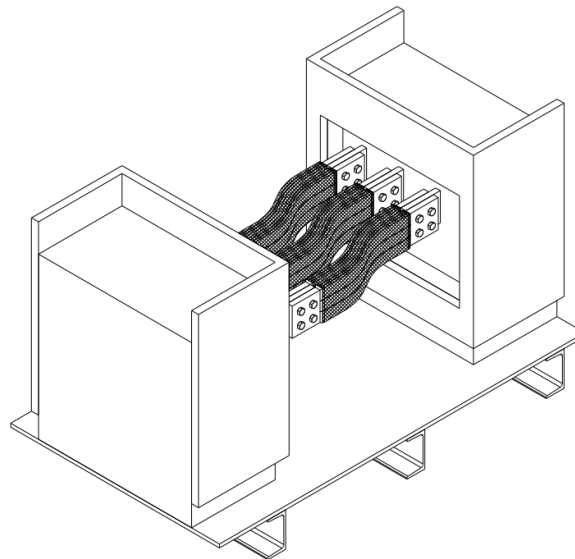

Cable Tray Bonding Straps

BURNDY Cable Tray Bonding Straps are used to create an electrical bonding connection between two sections of cable tray to ensure a continuous path to ground.

NEC Article 250.96 requires all metallic cable trays to be grounded regardless of whether or not the cable tray is being used as an equipment grounding conductor (EGC).

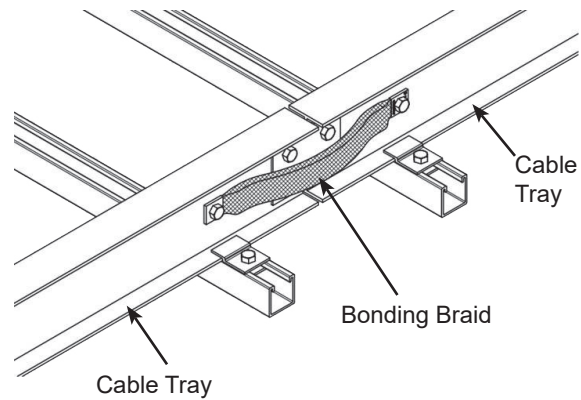

Minimum Size Equipment Grounding Conductors for Grounding Raceway and Equipment (excerpt of NEC Table 250.122)		
Rating or Setting of Automatic Overcurrent Device in Circuit Ahead of Equipment, Conduit, etc., Not Exceeding (Amperes)	Size (AWG or kcmil)	
	Copper	Aluminum or Copper-Clad Aluminum*
200	6	4
300	4	2
400	3	1
500	2	1/0
600	1	2/0
800	1/0	3/0
1000	2/0	4/0
1200	3/0	250
1600	4/0	350
2000	250	400

NOTE: Where necessary to comply with 250.4(A)(5) or (B)(4), the equipment grounding conductor shall be sized larger than given in this table.

*See installation restrictions in 250.120

BURNDY Cable Tray Bonding Straps					
Catalog Number	Overcurrent Protection Device Rating (Amperes)	** AWG Size or Equivalent	** Length (inches)	** Stud Size	Type†
BB048L12T38	300	#4	12	3/8"	Braid
BB067L12T38	500	#2	12	3/8"	Braid
BD12T38	600	#1	12	3/8"	Braid
CY1CL14D50LT38	600	#1	14.5	3/8"	Jumper
BE12T716	1000	2/0	12	7/16"	Braid
BF12T716	1600	4/0	12	7/16"	Braid
BG12T12	2000	250 kcmil	12	1/2"	Braid

**Other lengths, hole sizes, and AWG sizes or equivalents may be available, contact Customer Service

† Jumpers are manufactured using stranded bare copper code conductor with BURNDY UL Listed compression connectors on each end; Braid is manufactured of tinned, pure copper wire woven and flattened into rectangular shape for greater flexibility; ends of braids feature seamless copper ferrules.

Type BGRK Grounding Kits

BURNDY Grounding kits offer conveniently packaged components which simplify the decision making process at material acquisition and installation on the job site. These grounding kits bundle the same quality UL Listed connectors you trust with value-adding components such as: conductor, installation hardware, oxide inhibitor, labeling and installation instructions as an example. The kits are available in different variations with customized kits available upon request.

Features & Benefits

- Conveniently packaged for ease of procurement and installation
- Comprised of UL Listed components
- Wire brush free when installed with Telecom WEEB® washer
- TIA607 Compliant

6 AWG Ground Wire Kit Contents

Connectors (SERVIT® split bolt, HYDENT™ terminal, HYGROUND® C-style connector, or mechanical terminal)

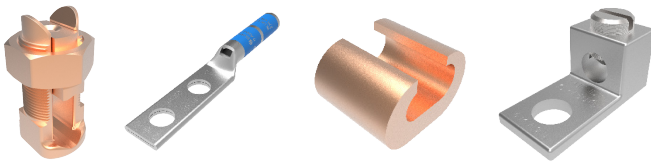

Conductors (6 AWG THHN wire, green PVC coated and/or Busbar)

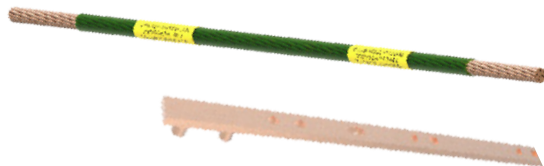

Labels (Caution labels, circle grounding symbol)



Hardware (Installation Hardware, Cable Ties, ESD Port Kit)

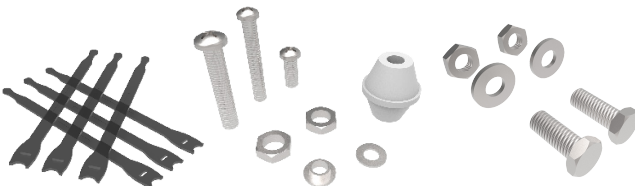

Oxide Inhibitor (0.5 oz tube of PENETROX™ A)



Ground Kit Example:

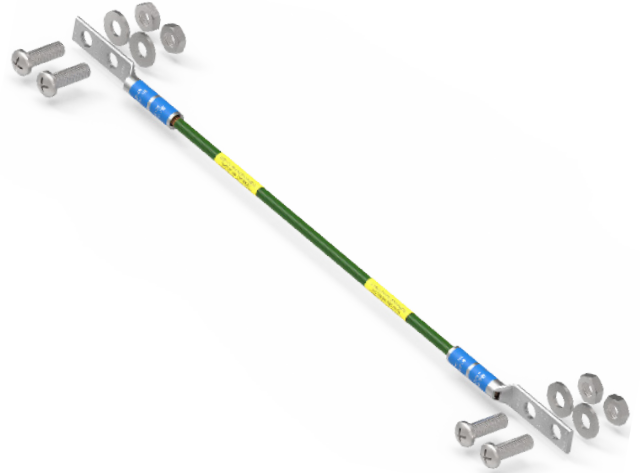

Application Example:
On-Rail Busbar Grounding Kit
Catalog Number:
BGRKTHC



Type BGRK

(Continued)



Application Example:
On-Rail Busbar Grounding Kit
Catalog Number: **BGRKTHC**



On-Rail Busbar Grounding Kit

Catalog Number	Contents:
BGRKTHC	19" Busbar with insulators
	60" of #6 AWG THHN wire, green PVC coated
	YAZ6C2TC14 terminal (precrimped)
	Busbar hardware kit
	ESD port kit
	8" black cable management straps
	Caution and Grounding labels
	0.5 oz. PENETROX™ A oxide inhibitor

Application Example:
In Cabinet Busbar Grounding Kit
Catalog Number: **BGRKTVC**



In Cabinet Busbar Grounding Kit

Catalog Number	Contents:
BGRKTVC	36" Busbar
	60" of #6 AWG THHN wire, green PVC coated
	YAZ6C2TC14 terminal (precrimped)
	Busbar hardware kit
	ESD port kit
	8" black cable management straps
	Caution and Grounding labels
	0.5 oz. PENETROX™ A oxide inhibitor



Type BGRK

(Continued)

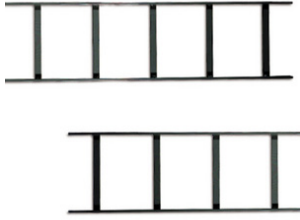

Ladder and Tray Grounding Kit

Catalog Number	Contents:
BGRKTKA9KA5	9" #6 AWG THHN wire, green PVC coated (9 pieces)
	KA6U mechanical terminal (10 pieces)
	Ground Kit Installation Hardware
	Caution and Grounding labels
	0.5 oz. PENETROX™ A oxide inhibitor

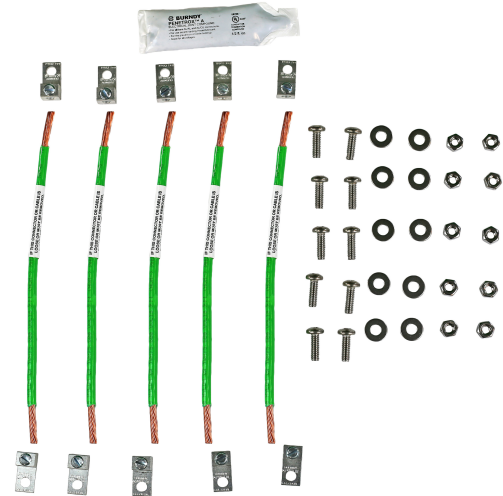

Catalog Number:
BGRKTKA9KA5



Wire Basket Tray Bonding Jumper Kit

Catalog Number	Contents:
BGRKTWB5	9" #6 AWG THHN wire, green PVC coated (9 pieces)
	KS23 mechanical SERVIT® split bolt (10 pieces)
	Ground Kit Installation Hardware
	Caution and Grounding labels



Catalog Number:
BGRKTWB5

Type BGRK

(Continued)

Ground Conductor / Jumper Kits

Catalog Number	Contents:
BGRKTD9D	9" #6 AWG THHN wire, green PVC coated
	YAZ6C2TC14 HYDENT™ terminals precrimped to each end of conductor
	Ground Kit Installation Hardware
	Caution and Grounding labels
	0.5 oz. PENETROX™ A oxide inhibitor
BGRKTD30DN	30" #6 AWG THHN wire, green PVC coated
	YAZ6C2TC14 HYDENT™ terminals precrimped to one end of conductor
	YAZ6C2TC1490 HYDENT™ terminals precrimped to other end of conductor
	Ground Kit Installation Hardware
	Caution and Grounding labels
BGRKTD60C46	60" #6 AWG THHN wire, green PVC coated
	YAZ6C2TC14 HYDENT™ terminal precrimped to one end of conductor
	YC4C6 Copper CRIMPIT™ connector precrimped to the other end of conductor
	Ground Kit Installation Hardware
	Caution and Grounding labels
	0.5 oz PENETROX™ A oxide inhibitor



Catalog Number:
BGRKTD9D

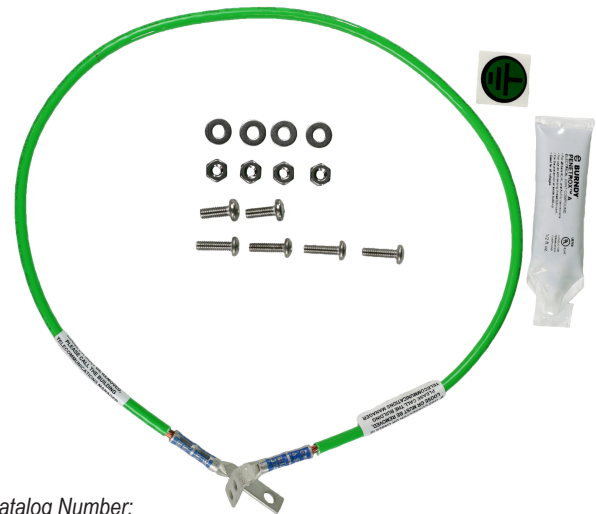

Catalog Number:
BGRKTD30DN

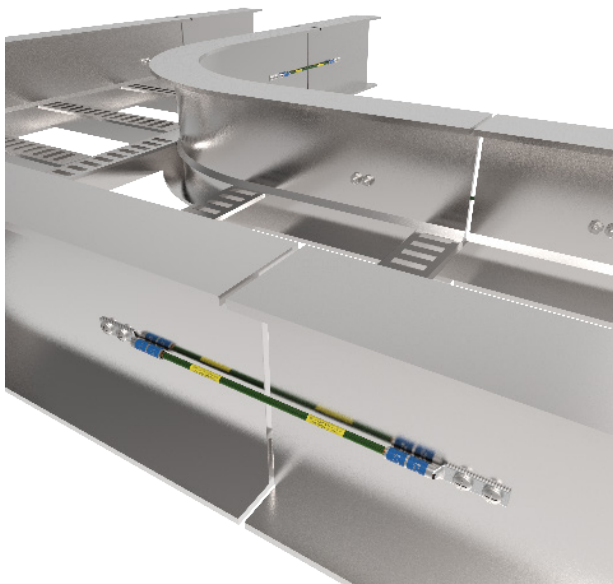

Catalog Number:
BGRKTD60C46

Type BBB Copper Bus Bar

Bare copper BusBar, UL Listed for grounding. Available in many sizes and hole patterns. Brackets and insulators included with most styles. Also available in undrilled, horizontal and vertical versions. BusBar is used in a variety of applications. Can be used as a common ground point and “power” applications as well.

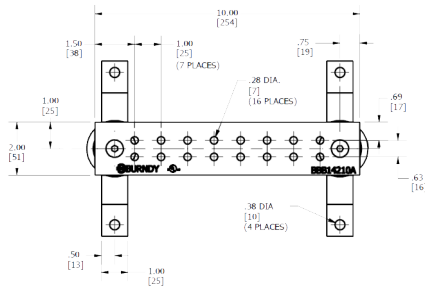
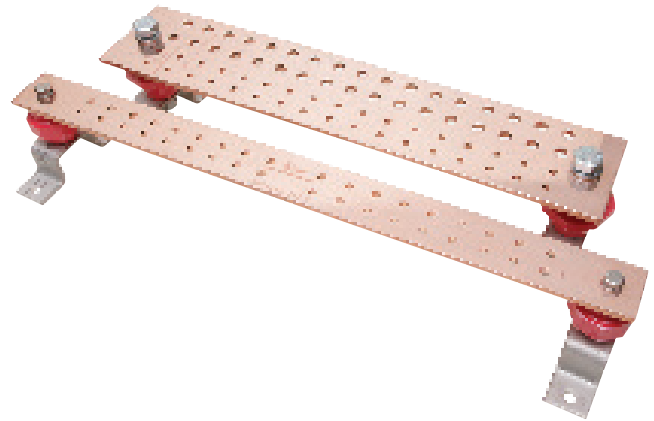

Figure 1

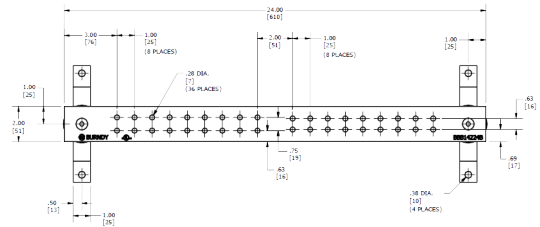

Figure 2

Catalog Number	Fig No.	T - Bar Thickness	W - Bar Width	L - Bar Length	E1	E2	E3	F1	F2	No. of Holes	K
BBB14210A	1	1/4"	2 in	10"	0.63	—	—	1.00	—	16	0.28
BBB14224B	2	1/4"	2 in	24"	0.62	0.75	—	1.00	1.00	36	0.28
BBB14410C	3	1/4"	4 in	10"	0.75	1.00	—	1.25	—	22	0.44
BBB14410D	4	1/4"	4 in	10"	1.25	1.00	—	1.13	1.13	22	0.44
BBB14412E	5	1/4"	4 in	12"	0.75	1.00	—	2.00	1.25	18	0.44
BBB14412F	6	1/4"	4 in	12"	1.00	0.75	—	2.00	1.25	24	0.44
BBB14416G	7	1/4"	4 in	16"	0.75	1.00	—	1.69	—	24	0.44
BBB14416H	8	1/4"	4 in	16"	1.00	1.00	0.75	1.69	—	32	0.44
BBB14420J	9	1/4"	4 in	20"	1.00	1.00	0.75	1.00	—	68	0.44
BBB412UD	—	1/4"	4 in	12"	N/A	N/A	N/A	N/A	N/A	0	—
BBB424UD	—	1/4"	4 in	24"	N/A	N/A	N/A	N/A	N/A	0	—
BBBHR19**	—	3/16"	3/4 in	19"	0.38	—	—	—	—	8	—
BBBVR36**	—	1/4"	5/8 in	36"	0.32	—	—	—	—	16	—

* Contact factory for custom sizes.

NOTE:

**BBBHR19 and BBBVR36 do not include insulator and brackets.
For separately ordering Insulator & Brackets use catalog number **B38723000**.

Type BBB (Continued)

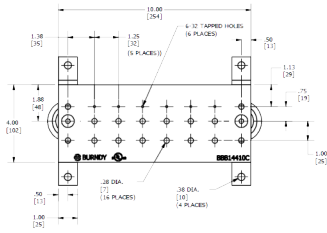

Figure 3

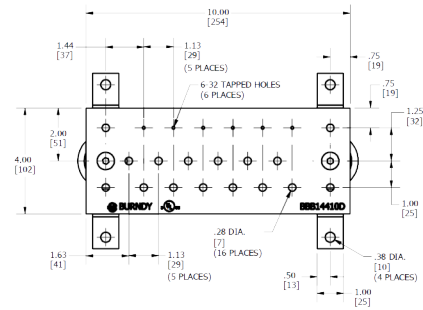

Figure 4

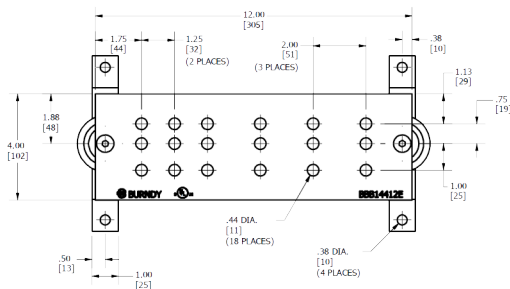

Figure 5

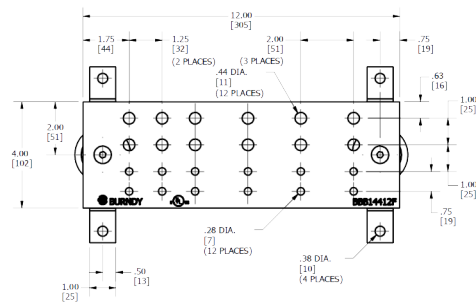

Figure 6

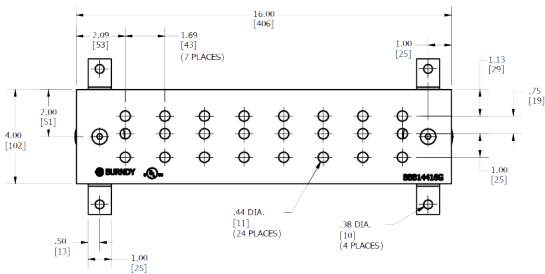

Figure 7

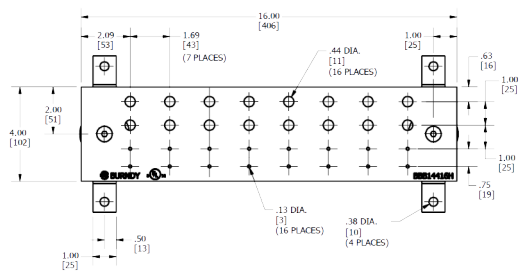

Figure 8

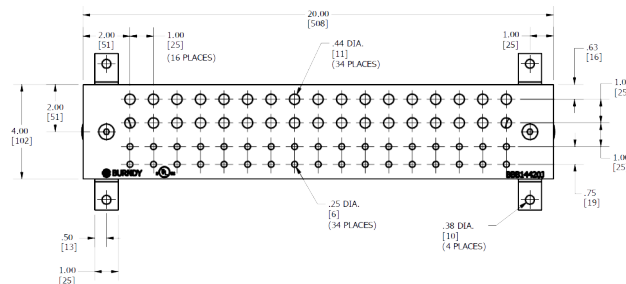
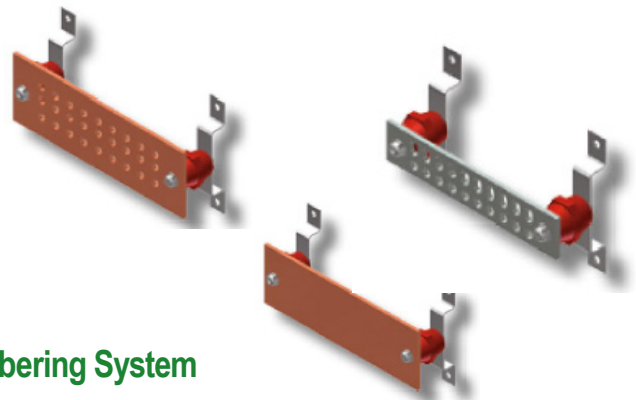

Figure 9

Bus or Ground Bars

Copper, Tinned Copper, and Stainless Steel
Bus or Ground Bar



cULus Listed bus or ground bars are available in a wide variety of configurations, hole and slot patterns, unplated copper, tin plated or stainless steel. These bars are available with or without brackets and insulators, a plexiglass cover is also available. For special applications necessitating a non-standard configuration, please contact Customer Service or your local sales representative..

Bus or Ground Bar Numbering System

Below is a guide on how to understand the ground bar numbering system. Each character of the catalog number represents specific details of our bars. Please note that other sizes, materials, and options may be available. Contact Customer Service or your local sales representative for more information.

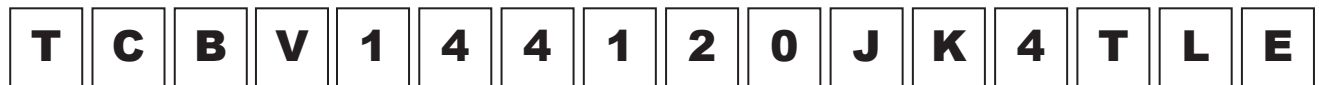

Bar Types Codes
CB: Plain Copper
TCB: Tinned Copper
SCB: Silver Plated Copper
SSB: Stainless Steel
GSB: Galvanized Steel
 Other materials may be available

Radius Corners
V: Radius Corners
 Blank - Standard Square Corners

Thickness
 Fractional thickness in inches of the bar
 example: 14 = 1/4"

Width
 Width of bar in inches

Length
 Length of bar in inches

Hole Pattern
 Requested hole pattern
 Blank if no holes desired

Pigtail Length
 (If req'd)
 See Chart for Pigtail Cable Length²

Stranding
 (If req'd)
 Blank for Stranded
 L for Solid

Tinned Pigtail
 (If req'd)
 Put T here for tinned
 Blank if not req'd

Pigtail (If req'd)
 See Pigtail Cable Size Chart¹

Pigtail #	Size
1	#6
2	#4
3	250 kcmil
4	#2
5	#1
6	1/0
7	2/0
8	500 kcmil
9	4/0

Pigtail Length	Length in Feet*
A	2'
B	5'
C	10'
D	15'
E	20'
F	25'
G	30'
H	35'

*Custom lengths available
 Contact the factory for more information

Assembly Type Codes:
K: Brackets & Insulators
B: Brackets Only
I: Insulators Only
C: Beam Clamps & Insulators
A: Brackets & Insulators with Anti-Theft Bolts
P: Plexiglass Cover (includes Brackets & Insulators)
T: TMGB Telecom Main Ground Bar Plexiglass Cover (includes Brackets & Insulators)
U: Universal (Includes Brackets, Insulators, Beam Clamps and Drive-In Anchors)
FAA1: Plexiglass Cover (includes Brackets & Insulators) Main Ground Plate
FAA2: Plexiglass Cover (includes Brackets & Insulators) Supplemental Ground Plate
FAA3: Plexiglass Cover (includes Brackets & Insulators) Multipoint Ground Plate
FAA4: Plexiglass Cover (includes Brackets & Insulators) Single Point Ground Plate
 Blank for Nothing (Bar ONLY)

NOTE: for FAA Ground Plate Options, reference FAA Ground Plate Options page.

Mechanical Grounding

Types CB, TCB, SSB
Bus or Ground Bar

Types CB, TCB, SSB

Copper, Tinned Copper, and Stainless Steel
Bus or Ground Bar



cULus Listed bus or ground bars are available in a wide variety of configurations, hole and slot patterns, unplated copper, tin plated or stainless steel. These bars are available with or without brackets and insulators, a plexiglass cover is also available. For special applications necessitating a non-standard configuration, please contact Customer Service or your local sales representative..

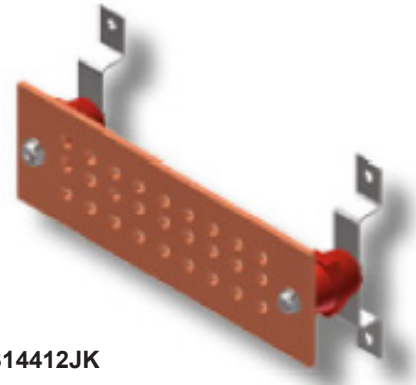

CB14412JK

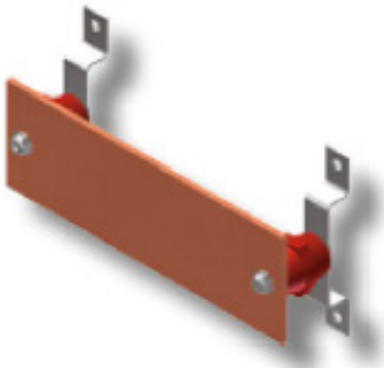

CB14412NK

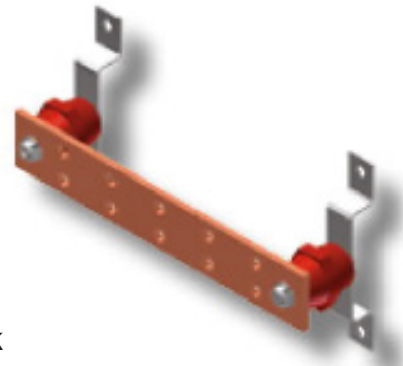

CB14212BK

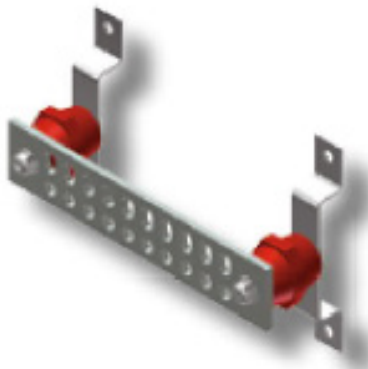

TCB14210PK

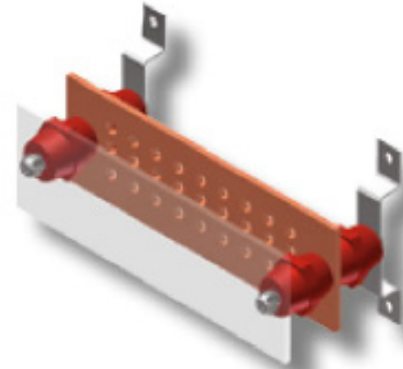

CB14412JP

Catalog Number	Hole Pattern	Insulator & Bracket	Tinned	Bar Size	# of Holes
CB14412JK	J	Yes	No	1/4" x 4" x 12"	27
CB14412M	M	No	No	1/4" x 4" x 12"	48
CB14412MK	M	Yes	No	1/4" x 4" x 12"	48
CB14210P	P	No	No	1/4" x 2" x 10"	26
CB14210PK	P	Yes	No	1/4" x 2" x 10"	26
CB14212P	P	No	No	1/4" x 2" x 12"	26
CB14212PK	P	Yes	No	1/4" x 2" x 12"	26

Types CB, TCB, SSB (Continued)

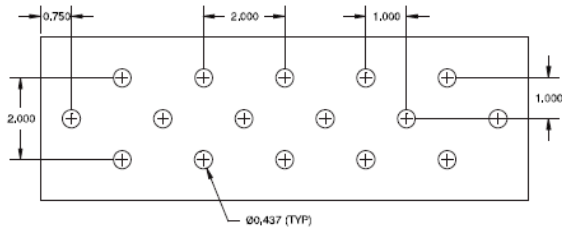

Pattern A

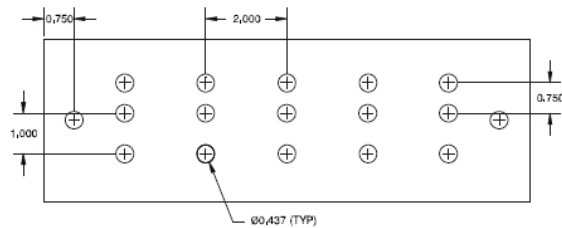

Pattern C

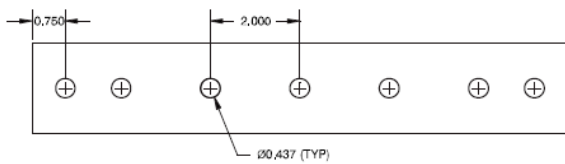

Pattern E

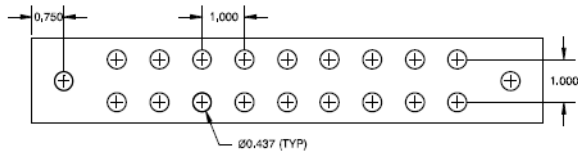

Pattern G

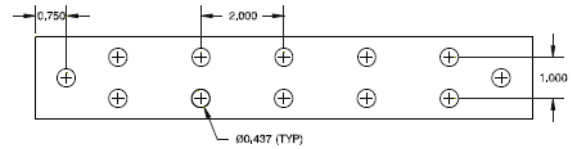

Pattern B

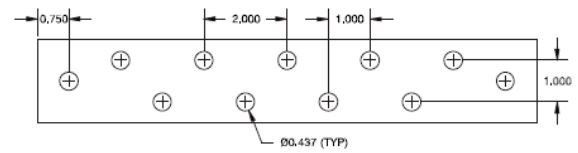

Pattern D

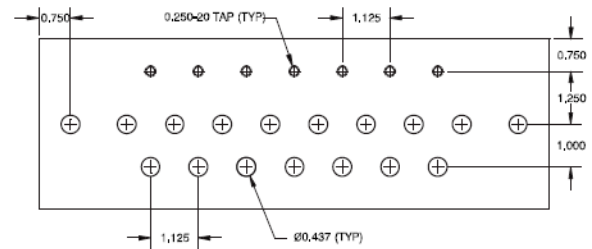

Pattern F

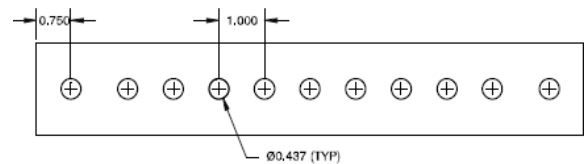

Pattern H

NOTES:

- All holes are 7/16" unless specified differently. To order threaded holes, specify hole size; the standard tapped hole size is 1/4"-20 unless specified otherwise
- Above bar patterns represent a 12" ground bar
- All bars are available with electro-tin plating
- For NEMA hole pattern ground bars, reference NEMA Ground Bar Hole Pattern Y on the following pages

Type CB (Continued)



NOTE:

For telecom ground bars - see Pattern S (next pages)

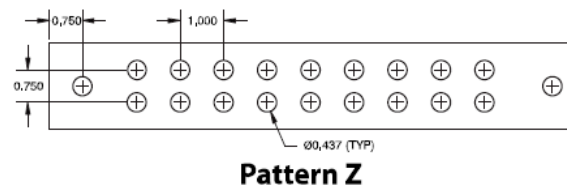
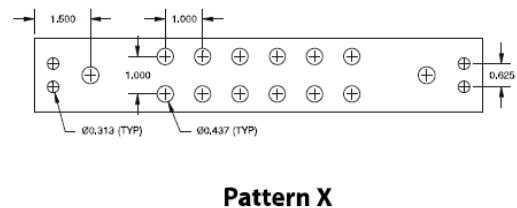
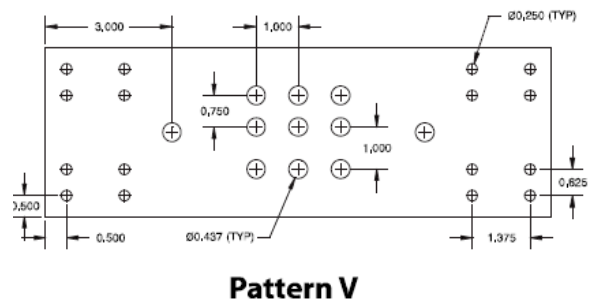
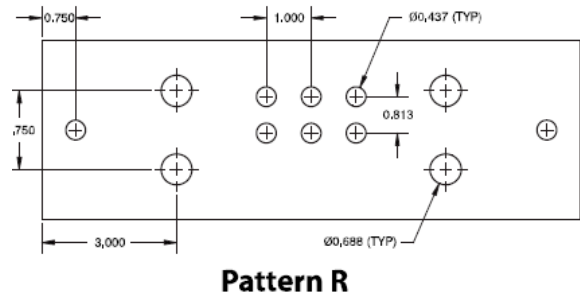
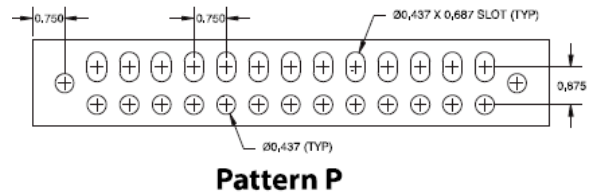
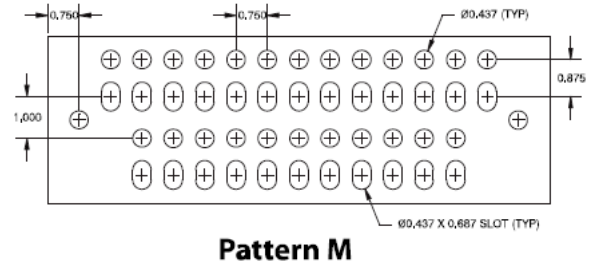
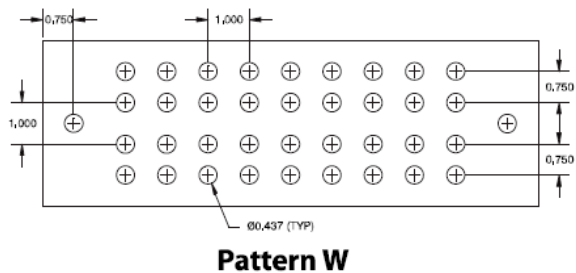
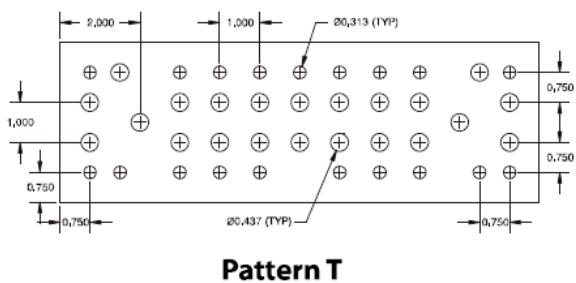
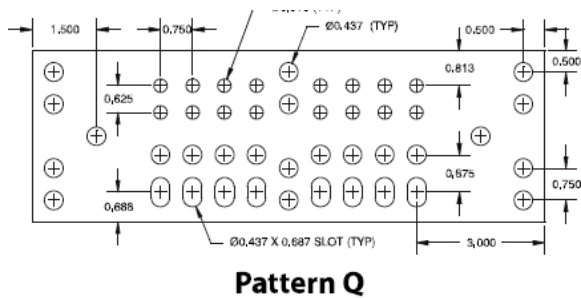
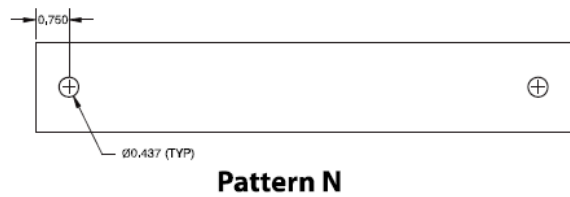
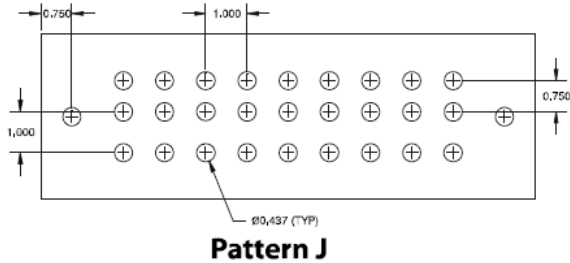

Type CB (Pattern S)
2" Telecom Bus or Ground Bar

Mechanical Grounding

Type CB (Pattern S)
2" Telecom Bus or Ground Bar

Catalog numbers as shown below are for the BAR ONLY; if you would like the kit (includes brackets and insulators) add K to the end of the catalog number (example shown to the right).

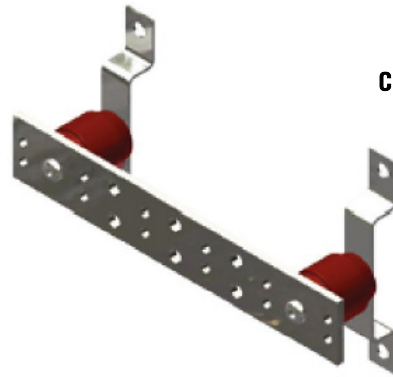

TCB14212SK

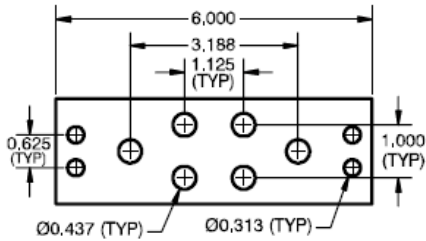

CB1426S

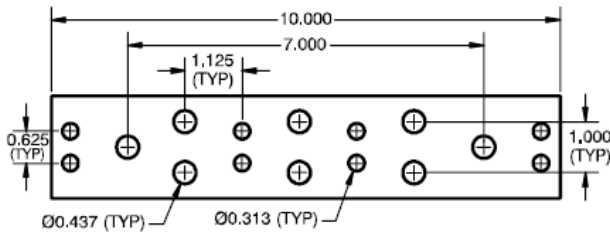

CB14210S

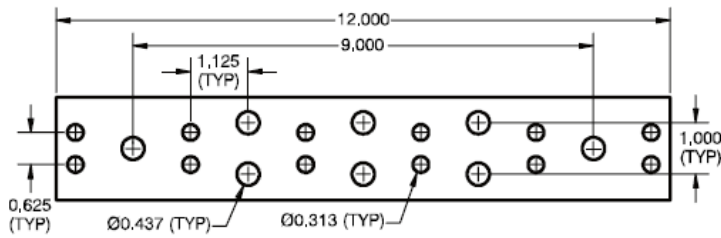

CB14212S

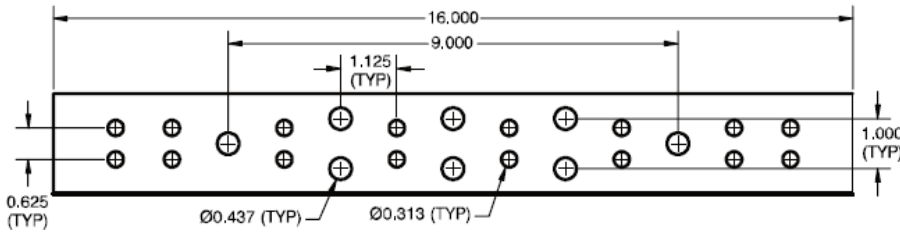

CB14216S

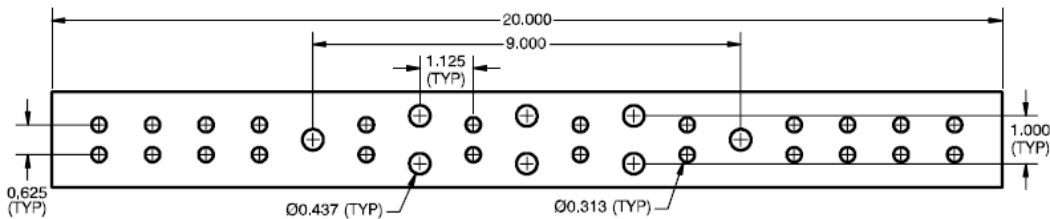

CB14220S

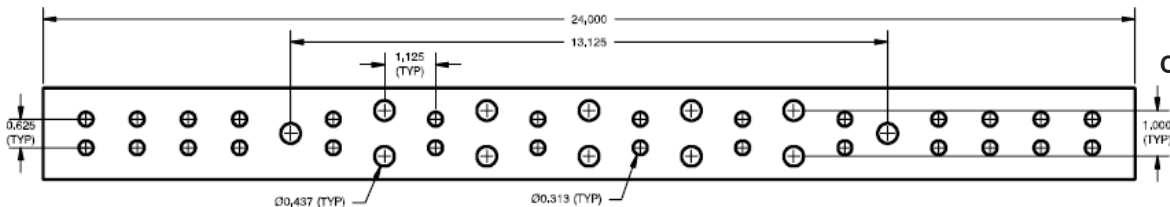

CB14224S

Mechanical Grounding

Type CB (Pattern S)
4" Telecom Bus or Ground Bar

Type CB (Pattern S) 4" Telecom Bus or Ground Bar

Catalog numbers as shown below are for the BAR ONLY; if you would like the kit (includes brackets and insulators) add K to the end of the catalog number (example shown to the right).



CB14412SK

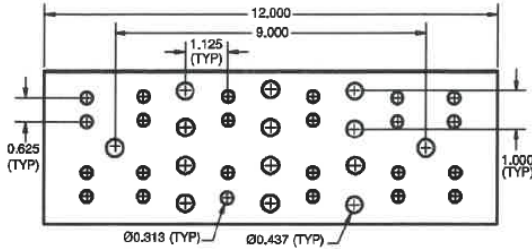

CB14412S

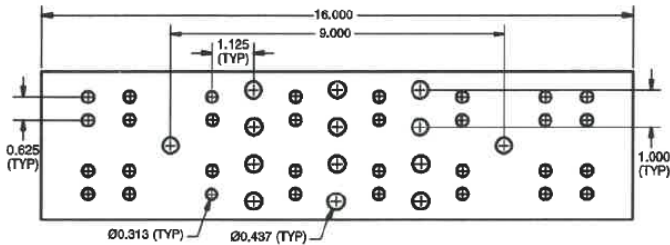

CB14416S

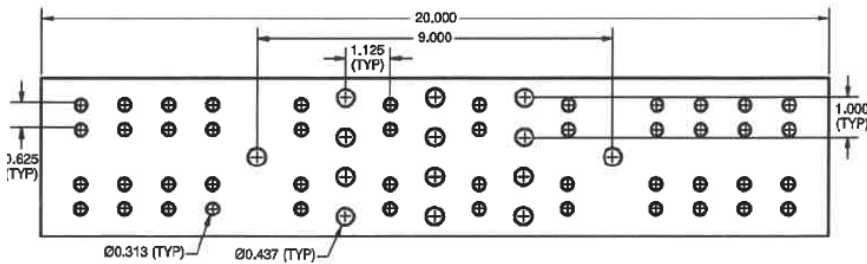

CB14420S

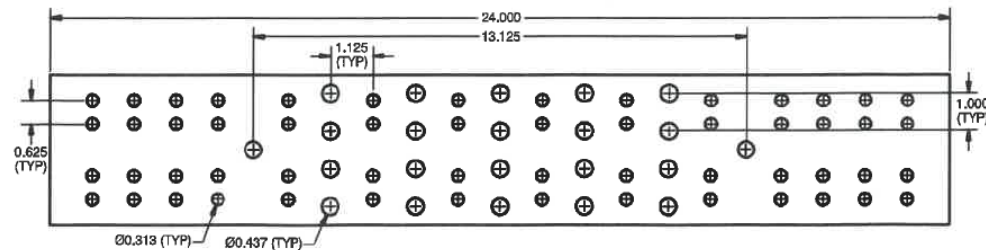

CB14424S

Type CB (Pattern Y)
NEMA Hole Pattern Bus or Ground Bar

Industry standard hole pattern in accordance with NEMA CC1 Standard. Add suffix "K" for insulators and brackets. Can be used with BURNDY Lugs with NEMA pads.

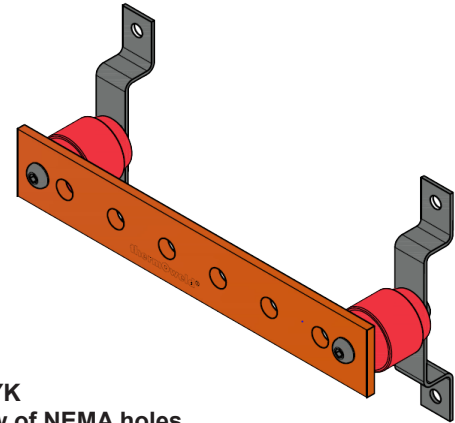
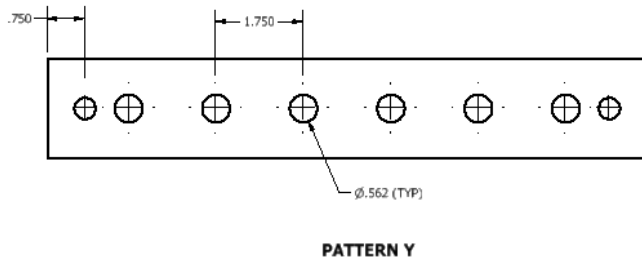

CB14212YK
Single row of NEMA holes

Single row of NEMA holes

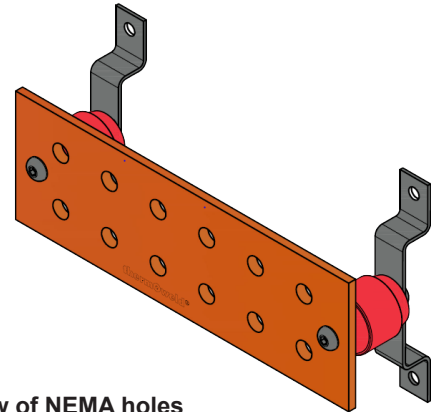
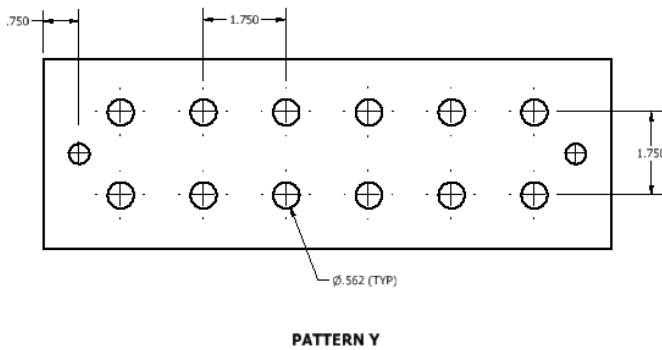

Double row of NEMA holes
CB14412YK

Double row of NEMA holes
on bars 3" and wider

Mechanical Grounding

FAA Ground Plate Options FAA Suffixes Used with Various Bars and Hole Patterns

Type CB (FAA-Suffix) FAA Ground Plate Options

FAA suffixes (FAA1, FAA2, FAA3, FAA4, etc.) may be used with various sized bars and hole patterns.

FAA Plexiglass Label Configurations are in accordance with the Department of Transportation Federal Aviation Administration Standard FAA-STD-019f.

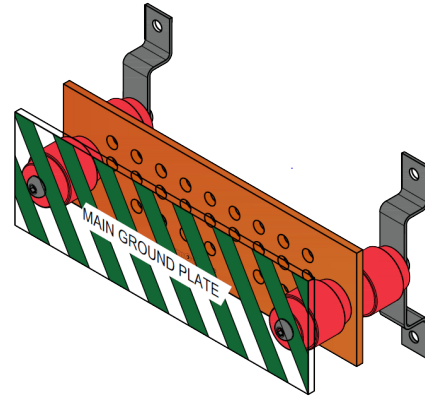

FAA1 = MAIN GROUND PLATE*
Alternating Green and Clear stripes



FAA2 = SUPPLEMENTAL GROUND PLATE*
Alternating Green and Clear stripes



FAA3 = MULTIPOINT GROUND PLATE*
Alternating Green and Orange stripes



FAA3 = SINGLE POINT GROUND PLATE*
Alternating Green and Yellow stripes

*NOTE: Plexiglass text shall be 3/8" high black lettering in Arial font.

Type CB (Patterns J and M)
Ground Bar



Pattern J				
Catalog Number	Description	Tinned	Bar Size	# of Holes
CB14412J	Bar Only	No	1/4" x 4" x 12"	27
TCB14412J		Yes	1/4" x 4" x 12"	27
CB14412JK	Bar with Insulators & Brackets	No	1/4" x 4" x 12"	27
TCB14412JK		Yes	1/4" x 4" x 12"	27
CB14420J	Bar Only	No	1/4" x 4" x 20"	51
TCB14420J		Yes	1/4" x 4" x 20"	51
CB14420JK	Bar with Insulators & Brackets	No	1/4" x 4" x 20"	51
TCB14420JK		Yes	1/4" x 4" x 20"	51
CB14424J	Bar Only	No	1/4" x 4" x 24"	63
TCB14424J		Yes	1/4" x 4" x 24"	63
CB14424JK	Bar with Insulators & Brackets	No	1/4" x 4" x 24"	63
TCB14424JK		Yes	1/4" x 4" x 24"	63

NOTES:

- Mounting holes not included in total
- Accommodates 2-hole lugs spaced 3/4", 1", and 1-3/4" on center
- 12" bar pictures; holes are 7/16" diameter
- Bars available electro-tin plated; with pigtails, tamper proof bolts, plexiglass cover
- Other sizes available, contact factory for details

Pattern M				
Catalog Number	Description	Tinned	Bar Size	# of Holes
CB14412M	Bar Only	No	1/4" x 4" x 12"	48
TCB14412M		Yes	1/4" x 4" x 12"	48
CB14412MK	Bar with Insulators & Brackets	No	1/4" x 4" x 12"	48
TCB14412MK		Yes	1/4" x 4" x 12"	48
CB14420M	Bar Only	No	1/4" x 4" x 20"	88
TCB14420M		Yes	1/4" x 4" x 20"	88
CB14420MK	Bar with Insulators & Brackets	No	1/4" x 4" x 20"	88
TCB14420MK		Yes	1/4" x 4" x 20"	88
CB14424M	Bar Only	No	1/4" x 4" x 24"	112
TCB14424M		Yes	1/4" x 4" x 24"	112
CB14424MK	Bar with Insulators & Brackets	No	1/4" x 4" x 24"	112
TCB14424MK		Yes	1/4" x 4" x 24"	112

NOTES:

- Mounting holes not included in total
- Accommodates 2-hole lugs spaced 3/4" and 1" on center
- 12" bar pictures; holes are 7/16" diameter, slots are 7/16" x 11/16"
- Bars available electro-tin plated; tamper proof bolts, plexiglass cover
- Other sizes available, contact factory for details

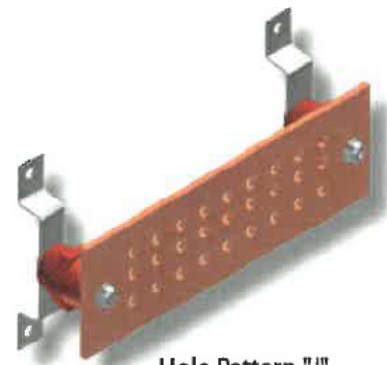

Hole Pattern "J"

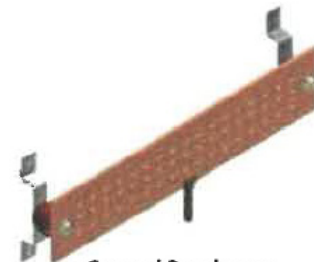

Ground Bar shown with optional pigtail.

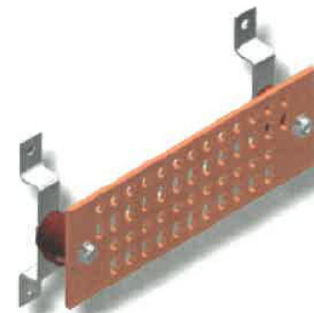

Hole Pattern "M"

Type CB (Pattern P) Ground Bar



Pattern P				
Catalog Number	Description	Tinned	Bar Size	# of Holes
CB1412P	Bar Only	No	1/4" x 2" x 12"	26
TCB14212P		Yes	1/4" x 2" x 12"	26
CB14212PK	Bar with Insulators & Brackets	No	1/4" x 2" x 12"	26
TCB14212PK		Yes	1/4" x 2" x 12"	26



Hole Pattern "P"

NOTES:

- Mounting holes not included in total
- Accommodates 2-hole lugs spaced 3/4" and 1" on center
- 12" bar pictures; holes are 7/16" diameter; slots are 7/16" x 11/16"
- Bars available electro-tin plated; with pigtails, tamper proof bolts, plexiglass cover
- Other sizes available, contact factory for details

Standoff Insulators (Red)

Manufactured from glass reinforced thermoset polyester					
Catalog Number	A	B	Shape	Thread Size	Voltage Rating
38-6330-00	1"	1"	Hexagon	1/4"-20 x 5/16" AL	600
38-6330-01	1"	1-1/4"	Hexagon	1/4"-20 x 5/16" AL	600
38-6331-00	2"	1-1/2"	Octagon	1/4"-20 x 7/16" STL	1500
38-6333-00	1-3/4"	2"	Round	3/8"-16 x 9/16" STL	2500
38-6334-00	2"	2"	Octagon	1/2"-13 x 5/8" STL	2500
38-6334-01	2"	2"	Octagon	3/8"-16 x 9/16" STL	2500
38-7725-00	2"	2-1/4"	Octagon	3/8"-16 x 9/16" STL	2700
38-7725-01	2"	2-1/4"	Octagon	1/2"-13 x 5/8" STL	2700
38-6335-00	2-1/2"	2-5/8"	Octagon	5/8"-11 x 3/4" AL	3400

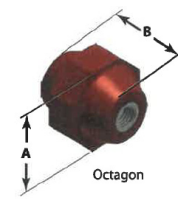
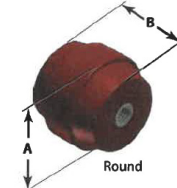
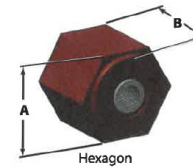

Mounting Brackets

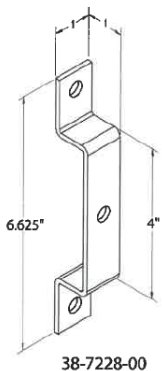

38-7228-00

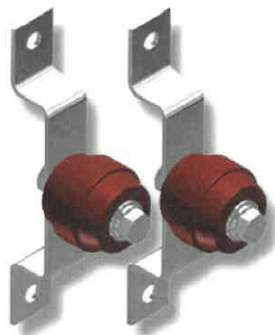

Catalog Number	Mounting Hole Size	H	Kit?
38-7230-00	7/16"	1"	Yes
38-7228-00	7/16"	1"	No

NOTES:

- Manufactured from 304 Stainless Steel
- Kit includes 2 of the assembly (pictured) plus the 3/8" hardware required to mount to a ground bar
- Mounting Kit uses 38-6333-00 insulators (round)

Perimeter Bar Numbering System

Below is a guide on how to understand the perimeter bus bar numbering system. Each digit of the catalog number represents specific details. Please note that other sizes, materials, and options may be available. Contact Customer Service or your local sales representative for more information. The example below indicates a plain copper perimeter bar, 1/4" thick, 4" wide, and 10' (120") long, with hole pattern AA, includes brackets and insulators.

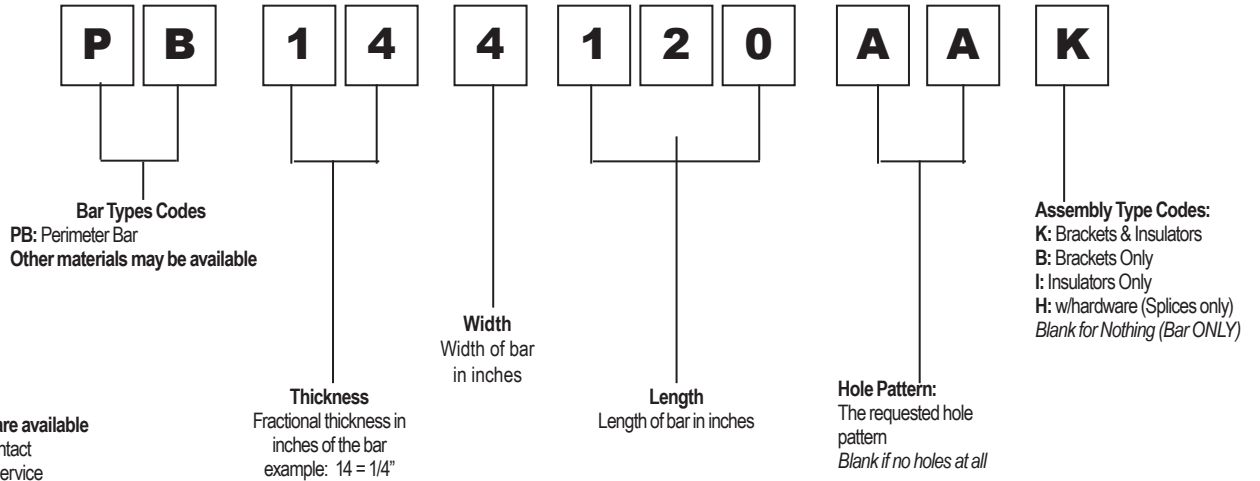

Radius Corners are available
Please contact
Customer Service

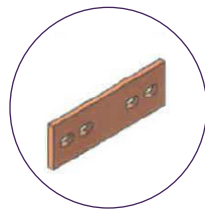
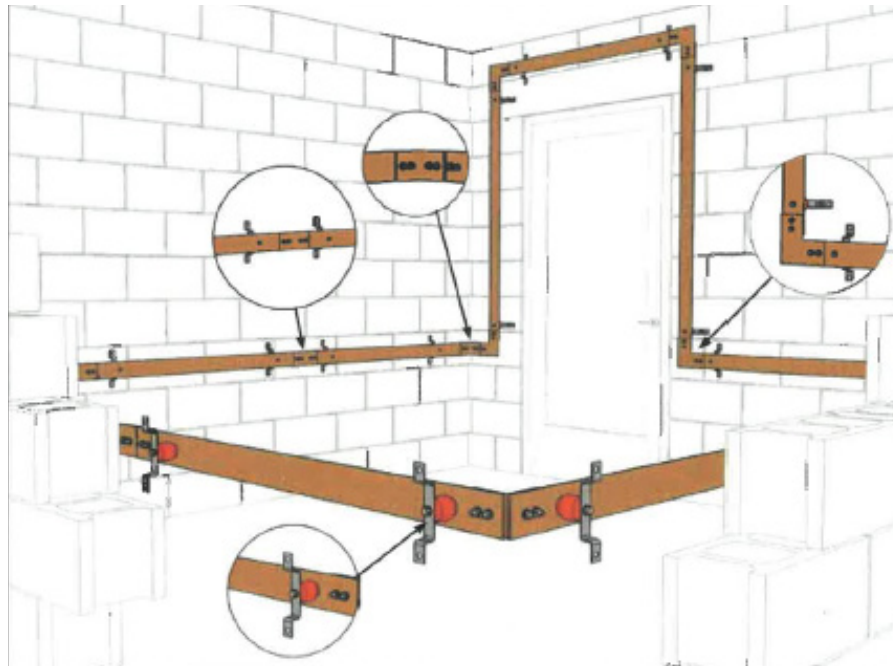

SPB Splice Plate



90SPB Splice Plate

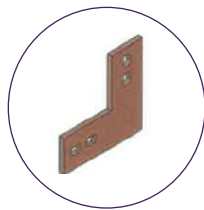

PLB Splice Plate

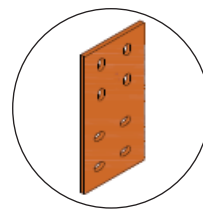

PPB Splice Plate

Perimeter Bus Bars

A perimeter bus bar system is designed to terminate ground wires and cables from equipment and other devices within a structure. The system encompasses straight bars, elbows, splicers, insulators and mounting brackets. This versatile system is great for clean rooms, data centers and laboratories when designing around corners and doors. Technical support can help with the designing of your system to meet your specific design criteria.

Perimeter Bus Bar Splices	
Catalog Number	Description
SPB1426NN	2" SPB Splice Plate
SPB1426NNH	2" SPB Splice Plate with Hardware*
SPB1449NN	4" SPB Splice Plate
SPB1449NNH	4" SPB Splice Plate with Hardware*
90SPB1424NN	2" 90 Degree SPB Splice Plate
90SPB1424NNH	2" 90 Degree SPB Splice Plate with Hardware*
90SPB1446NN	4" 90 Degree SPB Splice Plate
90SPB1446NNH	4" 90 Degree SPB Splice Plate with Hardware*
PLB1425NN	2" L Shape PLB Splice Plate
PLB1425NNH	2" L Shape PLB Splice Plate with Hardware*
PPB1448NN	4" PPB Splice Plate
PPB1448NNH	4" PPB Splice Plate with Hardware*



**38-7230-01
Mounting Kit**
(included by adding K to
catalog number)
or may be purchased
separately.

NOTES:

- With Hardware: consists of nuts, bolts flat and lock washers
- Mounting Kit 38-7230-01 included by adding suffix K; or available separately

NN Pattern

No hole pattern except mounting holes. Can be made to any length.

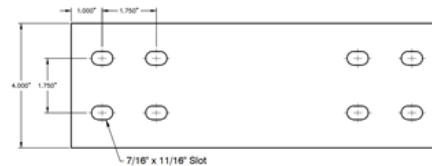
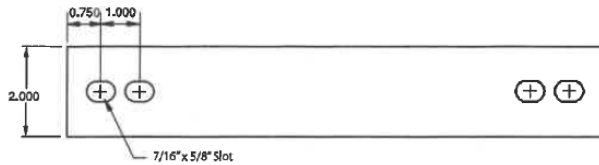

AA Pattern

Holes are spaced 36" apart, can be made to any length.

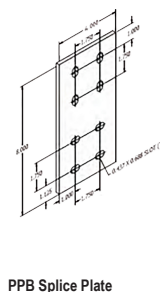
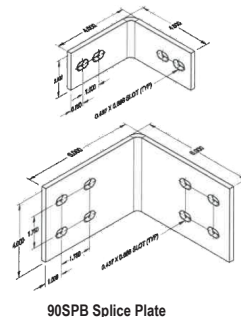
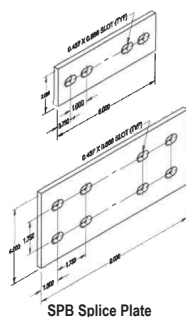
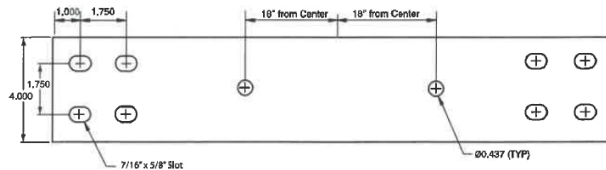
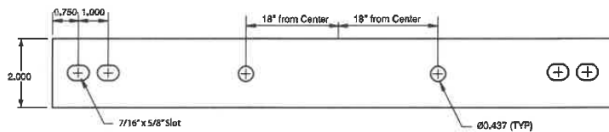

BURNDY® GRIDMAX®

Grounding, Personnel Safety Mats, Equipotential
Bonding, Pool and Spa Grounding

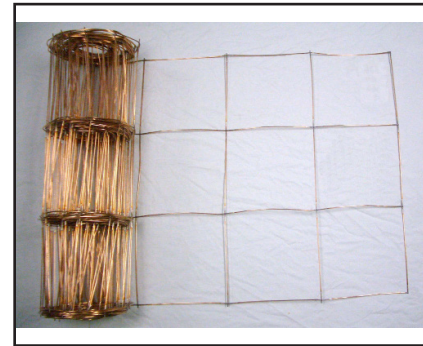

UL Listed Prefabricated Copper Ground Mesh

Prefabricated wire mesh is a simple and cost effective method of enhancing ground systems. Our Prefabricated wire mesh is used in the telecommunication industry to improve grounding and reduce electromagnetic interference. It is also used in power plants and sub-station facilities to reduce potential injury due to electrical discharge. We manufacture our ground mesh from solid copper or copper clad steel wire. The wire size range from #10 AWG to #4 AWG. We offer ground mesh with no overhang and overlapping ends typical .

Otherwise known as:

Gradient Mesh:	Canadian Standards & US -Pipeline
Equipotential Mesh:	NEC - Swimming Pools
Personnel Safety Mat:	IEEE80
Ground Mesh:	UL467

Overlapping Ends

This configuration is designed to allow for side by side connections of adjoining mats; thus providing the easiest method of joining two mesh sections. Adding 2" to one half the conductor spacing provides the overlapping ends. For example, if the mesh size is 6" square, the overlapping end length is 5".

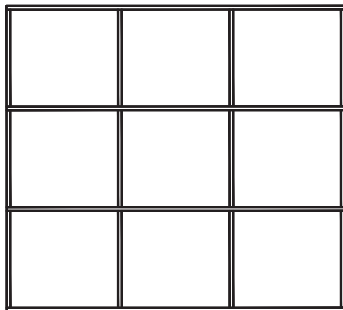

Without Overhang

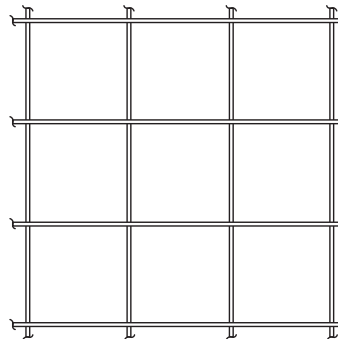

With Overhang

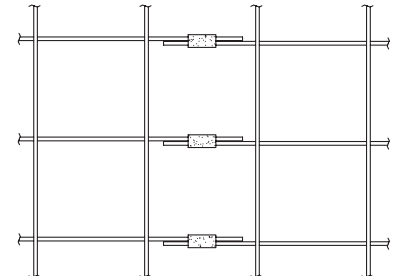

"Overlapping" ends

Features and Benefits:

- Manufactured from bare solid copper
- Spaced on 4", 6", or 12" centers
- Copper to copper weld with 15% silver
- Furnished in section with lengths from 4' to 100'
- Easily and economically installed using thermOweld® exothermic process, HYGROUND® Compression system, or our full line of Mechanical connectors
- Sizes of GRIDMAX® specifically designed for the Pool and Spa market of 3' x 100' and 3' x 50', but can be used where any large area grounds are required

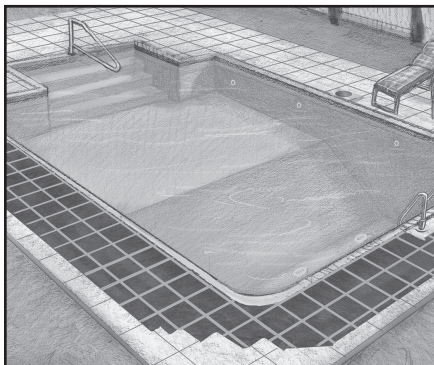

Example:
GRIDMAX®
3' wide in pool area

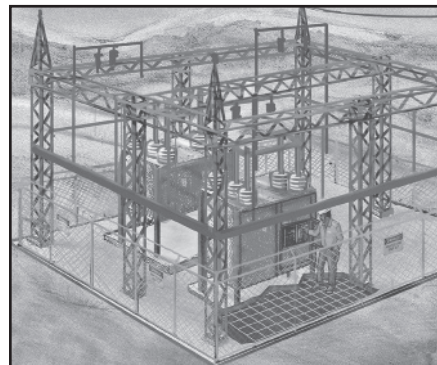

Example:
GRIDMAX®
Personnel Safety Mat

BURNDY® GRIDMAX®

Grounding, Personnel Safety Mats, Equipotential Bonding, Pool
and Spa Grounding

UL Listed Prefabricated Copper Ground Mesh



GRIDMAX® Ground Mesh Numbering System Example

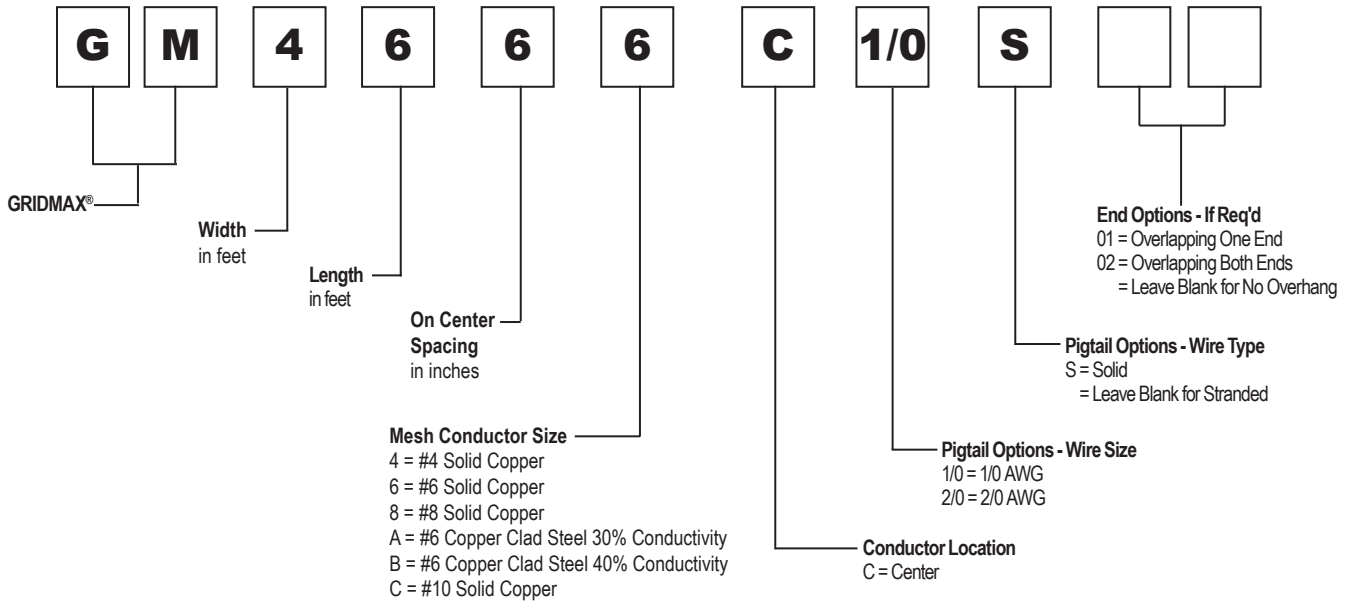

Catalog Number	Description
GM4666C1/0S	4' x 6' x 6" On Center - #6 Solid Copper - Center Conductor 1/0 Solid Pigtail
GM4666	4' x 6' x 6" On Center - #6 Solid Copper
GB468B	4' x 6' x 8" On Center - #6 Copper Clad Steel 40% Conductivity
GB105012801	10' x 50' x 12" On Center - #8 Solid Copper with Overhang One End
GB1230126	12' x 30' x 12" On Center - #6 Solid Copper

*Custom sizes and options available upon request, contact Customer Service for details.

Notes:

- Overlapping ends are equal to 1/2 the spacing plus 2"; Don't count overhang for total dimensions
- Center wire conductors overhand 6" on each end
- Type Sizes: 4' x 4' and 4' x 6'. Mesh is also available on rolls, contact Customer Service for details
- Silver Solder Brazed
- Minimum spacing available is 2"; UL467 allows 4" to 24" spacing for Listing

BURNDY® GRIDMAX®

Grounding, Personnel Safety Mats, Equipotential
Bonding, Pool and Spa Grounding

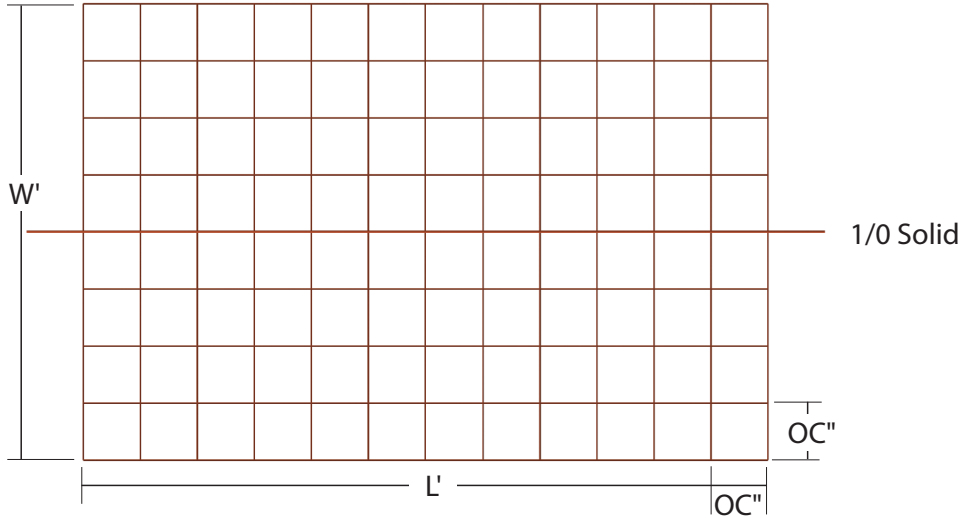

GM4666C1/0S

Type		Width (W)	Length (L)	O.C. Spacing	Conductor	Pigtail Options					
G	M	4	6	6	6	C	1	/	0	S	
Ground Mesh		Width in Feet	Length in Feet	On Center Spacing in Inches	Conductor Size and Type	Pigtail Conductor Location, Size and Type					

Table of Contents

thermOweld® Exothermic Process	E-117	thermOweld® Accessories	
Making a thermOweld® Exothermic Connection	E-118	Cable Clamp	E-147
thermOweld® EZ Lite® Battery Ignition System.....	E-119	Cable Cleaning and Card Cloth Brush.....	E-147
thermOweld® Weld Metal and Steel Discs	E-120	Mold Cleaners	E-147
thermOweld® Molds		Packing Material.....	E-147
Type CC-1 Horizontal End to End	E-121	Tool Kit.....	E-148
Type CC-2 Horizontal Cable Tap to Horizontal Cable Run	E-122	Tools (separately)	E-148
Type CC-4 Horizontal to Horizontal Cable Cross	E-123	Rasp	E-148
Type CC-11 Horizontal to Horizontal Cable Cross	E-124	Flint Ignitor.....	E-148
Type CC-6 Horizontal Parallel Tap.....	E-125	thermOweld® Ground Rod Driving Sleeves	E-149
Type CC-14 Horizontal Parallel Through Cables	E-125	thermOweld® Shim Stock and Adapter Sleeves.....	E-149
Type CC-7 Horizontal Parallel Through Cables	E-126		
Type CR-1 Horizontal Cable Terminal to Ground Rod.....	E-127		
Type CR-2 Horizontal Cable to Ground Rod	E-128		
Type CR-3 Horizontal Through Cable to Ground Rod.....	E-129		
Type CR-17 Horizontal Run and Tap Cables to Ground Rod.....	E-130		
Type CR-24 Horizontal Parallel Run Cables to Ground Rod	E-131		
Type CS-1 Horizontal Cable to Horizontal Steel Surface	E-132		
Type CS-8 Horizontal Cable to Horizontal Steel Surface.....	E-132		
Type CS-2 Horizontal Through Cable to Horizontal Steel Surface.....	E-133		
Type CS-9 Horizontal Through Cable to Horizontal Steel Surface.....	E-133		
Type CS-3 Angular Cable Drop to Vertical Steel Surface	E-134		
Type CS-23 Vertical Cable Drop to Vertical Steel Surface.....	E-135		
Type CS-4 Vertical Through Cable to Vertical Steel Surface	E-135		
Type CS-6 Horizontal Through Cable to Vertical Steel Surface	E-136		
Type CS-7 Overhead Vertical Tap Cable to Vertical Steel Surface.....	E-136		
Type CS-18 Horizontal Tap Cable to Vertical Steel Surface	E-137		
Type CS-5 Horizontal Cable Tap to Horizontal Cast Iron Surface.....	E-137		
Type CRE-1 Horizontal Parallel Tap to Rebar.....	E-138		
Type CRE-2 Horizontal Cable Tap to Horizontal Rebar Run	E-139		
Type CRE-3 Horizontal Through Cable to Vertical Rebar.....	E-140		
Type CRE-4 Horizontal Through Cable to Horizontal Rebar.....	E-141		
Type CRE-6 Horizontal Cable Tap to Vertical Rebar	E-142		
thermOweld® Contact - GF.....	E-143		
thermOweld® Handle Clamps.....	E-145		
thermOweld® Handle Attachment.....	E-145		
thermOweld® Mold Support Clamp	E-145		
thermOweld® Vertical Magnetic Clamps.....	E-146		
thermOweld® Horizontal and Vertical Chain Clamps.....	E-146		

Most frequently ordered catalog numbers are highlighted in BLUE

thermOweld® Exothermic Process

The thermOweld® connection process is a simple, efficient method of welding copper to copper or copper to steel. One advantage is that NO outside power is required when using the thermOweld® exothermic process. The thermOweld® process uses high temperature reaction of powdered copper oxide and aluminum. The reaction takes place in a semi-permanent graphite mold. These molds will last for fifty or more welds if proper care is given. The reaction takes place very rapidly, therefore the total amount of heat applied to the conductors or surfaces is considerably less than that of brazing or soldering. It is important to remember this when welding to insulated cable or thin wall pipe.

This system is very field friendly, since it is light and portable and requires no outside power source. It requires very little time or skill to obtain an efficient, maintenance free connection when using the thermOweld® process.

For more information, visit our website at:
www.burndy.com.

The thermOweld® process has been used to weld materials other than copper for electrical purposes. Materials welded include:

- Stainless Steel
- Copperweld®
- Nichrome V
- Galvanized Steel
- Silicon Bronze
- Copper Clad Steel
- Columbium
- Plain Steel
- Everdur®
- Kama
- Stell Rail
- Cor-Ten®
- Brass
- Bronze
- Niobium
- Chromax
- Cast Iron
- Monel

When welding to galvanized steel it is recommended to resurface exposed bare steel.

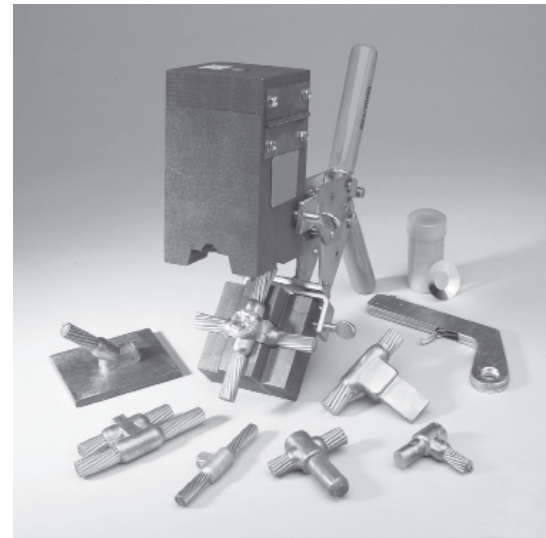

The thermOweld® connection is a molecular weld. The weld metal has the same melting point as copper. These factors along with the increased cross section of the connection, thermOweld® connections:

1. Will not be affected by a high current surge. Tests have shown that the electrical conductor will melt before the thermOweld® connection when subjected to high short circuit current. Consult IEEE Standard 837-1989.
2. Will not loosen or corrode at the point of weld. There are no contact surfaces or mechanical pressures involved. A thermOweld® connection becomes an integral part of the conductor.
3. Have a current-carrying capacity equal to or greater than that of the conductors.

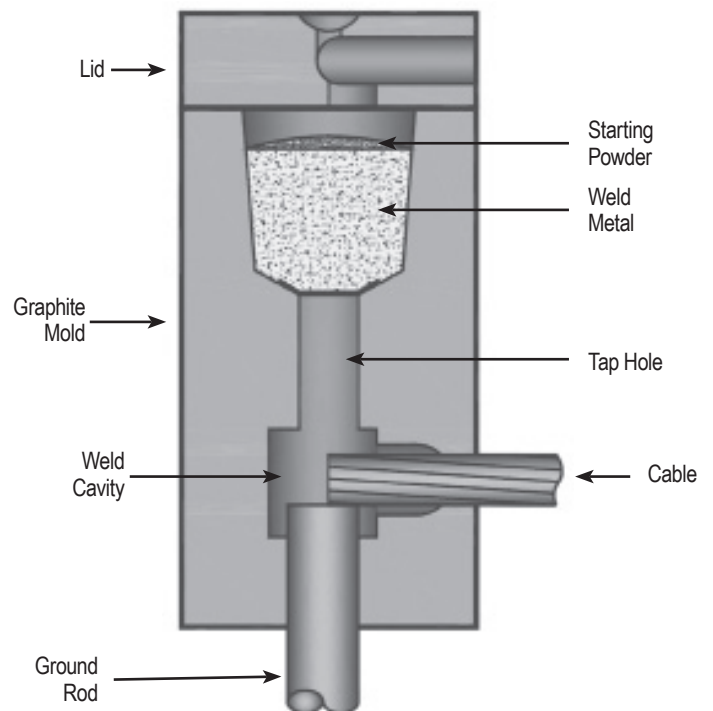

Making a thermOweld® Connection

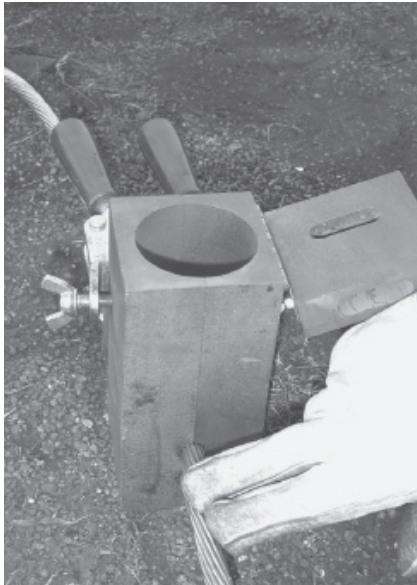

Step 1

Position cleaned conductors in mold after make sure mold is dry, by pre-heating or making a test joint.

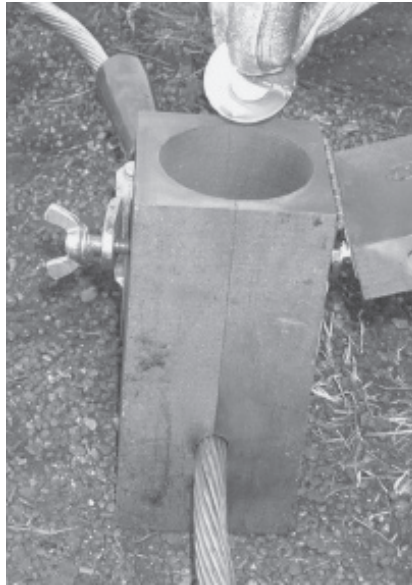

Step 2

Place metal disc in bottom of mold crucible.



Step 3

Dump powder into crucible, being careful not to loosen all the starting powder.

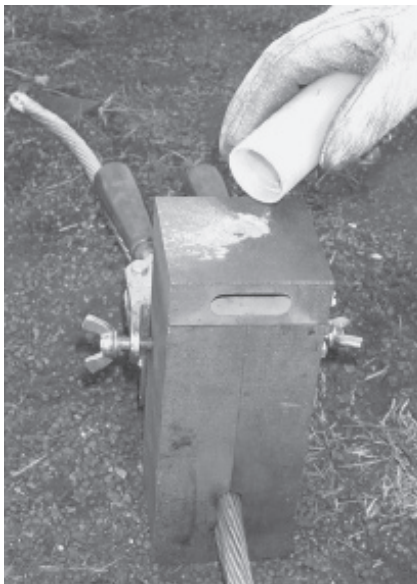

Step 4

Close lid and place a small amount of starting powder in the ignition pocket.



Step 5

Ignite the starting powder with the Flint Ignitor.

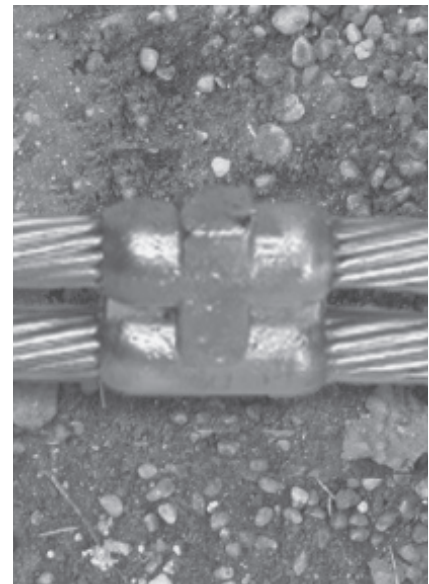

Step 6

Wait 15 seconds, then remove weld and clean mold before making next connection.

thermOweld® EZ Lite® Battery Ignition System

The self-contained unit offers a built-in battery life indicator, 6' ignitor cord and separate buttons for power and ignition. Also, no starting powder is used with this system so emissions are greatly reduced. EZ Lite® works with "off-the-shelf" molds and weld metal, so contractors and installers can continue to use the same quality thermOweld® products.

Since the unit operates with standard weld metal and molds, installers also have the option of using a traditional flint ignitor or the new EZ Lite® system. Another feature is the speed of ignition, with virtually no delay between depressing the "push to operate" button and ignition of the weld metal. This instant ignition feature offers quick reassurance to the installer, without the delay.

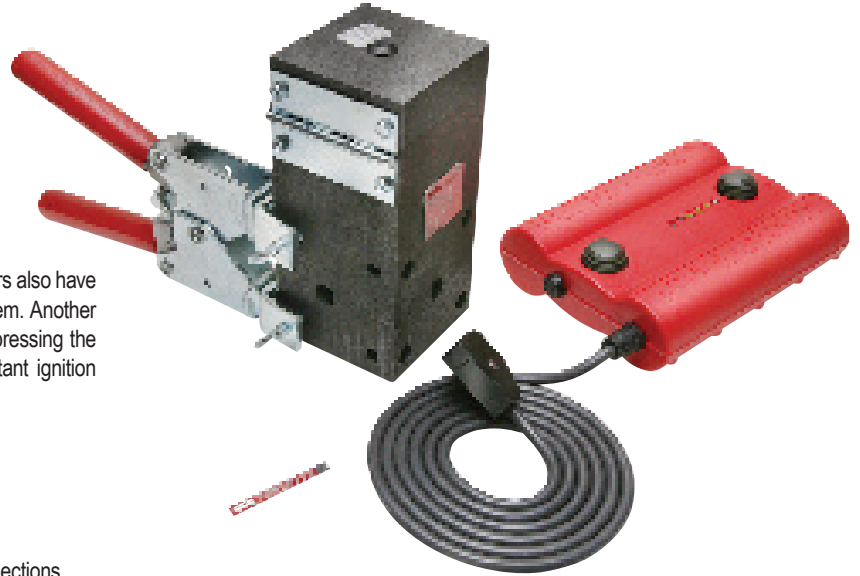

Features & Benefits

- The EZ Lite® system allows installers to make exothermic connections remotely
- Uses standard exothermic molds and weld metal
- Use the thermOweld® EZ Lite® battery ignition system or use a flint ignitor, making this the most versatile system available
- Installers have virtually 100% confidence that the connection can be completed with no wasted material or weld metal shots
- No starting material required which greatly reduces the amount of emissions generated
- Power is supplied by 4 standard "D" size batteries
- Built-in battery life indicator
- Virtually no delay in ignition after depressing the "push to operate" button
- Separate ON/OFF and Operate buttons
- Comes complete with durable 6 foot heat resistant cord
- Durable, long-lasting design
- EZ Lite® ignitor sticks (38EZLITIG) are conveniently packaged and available separately or packaged complete with standard weld metal

Catalog Number	Description
38EZLTRU	Battery Ignition System
38EZLTSK	EZ Lite® Battery Ignition System and 20 38EZLITIG Ignitor Sticks

Catalog Number Standard Cartridge Size with Ignitor	Cartridges/ Ignitors Per Box
TW15EZ	20
TW25EZ	20
TW32EZ	10
TW45EZ	20
TW65EZ	20
TW90EZ	10
TW115EZ	10
TW150EZ	10
TW200EZ	10
TW250EZ	10
TW500EZ	10
38EZLITIG*	10

* Ignitor stick only.

thermOweld® Weld Metal

thermOweld® Weld Metal is packed in moisture-resistant plastic cartridges that have tight fitting caps. These cartridges, along with the necessary steel discs, are then packed in boxes that are hermetically sealed. This ensures the powder arriving in good condition, always dry and ready for fast positive ignition. thermOweld® Weld Metal comes in several types; one for welding copper to copper, copper to steel, copper to cast iron and one for welding copper to steel for cathodic protection. The size and weight (in grams) of the cartridge are marked on each individual cartridge.

Weld metal and steel discs are sold only in standard box quantities.

Features & Benefits

- Packed in moisture-resistant plastic cartridges with tight fitting caps
- Cartridges, along with necessary steel discs, are packed in boxes that are hermetically sealed ensuring the powder arrives in good condition, dry and ready for fast, positive ignition



Weld Metal Size	Catalog Number Steel Discs Only	Package Quantity
15 to 65	37-0320-01	20
90 to 115	37-0320-02	10
150 to 500	37-0320-03	10

Catalog Number	Description	Cartridges Per Box
15	Standard Cartridge	20
25	Standard Cartridge	20
32	Standard Cartridge	10
45	Standard Cartridge	20
65	Standard Cartridge	20
90	Standard Cartridge	10
115	Standard Cartridge	10
150	Standard Cartridge	10
200	Standard Cartridge	10
250	Standard Cartridge	10
500	Standard Cartridge	10

Type CC-1 Molds Horizontal End to End

Type CC-1 Molds are used for horizontal end to end cable connections. Size range from #6 through 1000 kcmil solid or concentric stranded copper conductors. Contact BURNDY® for information on molds for use with conductors not listed.

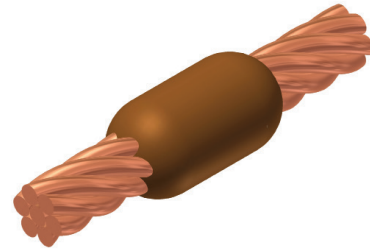

Cable		Mold Number	Price Key	Weld Metal	Handle Clamps
Run	Tap				
#4	#4	M-5623	18 ①	25	Incl.
#3	#3	M-5624	18 ①	32	Incl.
#2	#2	M-5625	18 ①	32	Incl.
#1	#1	M-5626	18 ①	32	Incl.
1/0	1/0	M-205	4	45	B-106
2/0	2/0	M-206	4	65	B-106
3/0	3/0	M-207	4	90	B-106
4/0	4/0	M-208	4	90	B-106
250 kcmil	250 kcmil	M-209	4	115	B-106
300 kcmil	300 kcmil	M-210	4	115	B-106
350 kcmil	350 kcmil	M-211	4	150	B-106
500 kcmil	500 kcmil	M-213	4	200	B-107
750 kcmil	750 kcmil	M-214	5	2-150	B-107
1000 kcmil	1000 kcmil	M-215	5	2-200	B-107

① 38-0309-00 Flint ignitor included

NOTES:

- For sizes not listed, contact BURNDY®
- Molds listed are for concentric stranded cable; add suffix "-S" to mold number for solid conductors
- For heavy duty molds, molds with wear plates or molds for Copperweld® cable, contact BURNDY®
- For expedited service, contact BURNDY®

Required Tools:

Handle Clamps - see chart for correct handle catalog number

Recommended Accessories:

- 38-0309-00 Flint Ignitor
- 38-3922-00 Mold Cleaning Brush
- 38-0135-00 Cable Cleaning Brush
- 38-0330-00 Cable Clamp

Type CC-2 Molds

Horizontal Cable Tap to Horizontal Cable Run

Type CC-2 Molds are used to join horizontal cable tap to a horizontal run cable. Size range is #6 through 750 kcmil solid or concentric stranded copper conductors. Contact BURNDY® for information on molds for conductors not listed below.

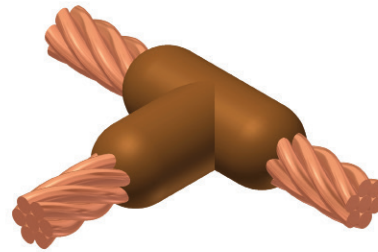

Cable		Mold Number	Price Key	Weld Metal	Handle Clamps
Run	Tap				
#4	#4	M-221	4	32	B-106
#2	#2	M-223	4	45	B-106
	#4	M-224	4	45	B-106
#1	#1	M-225	4	45	B-106
	#2	M-226	4	45	B-106
	#4	M-227	4	45	B-106
1/0	1/0	M-228	4	90	B-106
	#1	M-229	4	45	B-106
	#2	M-230	4	45	B-106
	#4	M-231	4	45	B-106
2/0	2/0	M-232	4	90	B-106
	1/0	M-333	4	90	B-106
	#1	M-234	4	45	B-106
	#2	M-235	4	45	B-106
	#4	M-5475	4	45	B-106
3/0	3/0	M-236	4	115	B-106
	2/0	M-237	4	90	B-106
	1/0	M-238	4	90	B-106
	#1	M-239	4	45	B-106
	#2	M-240	4	45	B-106
	#4	M-5574	4	45	B-106
	#4	M-241	4	150	B-106
4/0	3/0	M-242	4	115	B-106
	2/0	M-243	4	90	B-106
	1/0	M-244	4	90	B-106
	#1	M-245	4	90	B-106
	#2	M-246	4	90	B-106
	#4	M-5021	4	90	B-106
	250 kcmil	M-247	4	150	B-106
	4/0	M-248	4	150	B-106
250 kcmil	3/0	M-249	4	150	B-106
	2/0	M-250	4	90	B-106
	1/0	M-251	4	90	B-106
	#1	M-252	4	90	B-106
	#2	M-253	4	90	B-106

Cable		Mold Number	Price Key	Weld Metal	Handle Clamps	
Run	Tap					
300 kcmil	300 kcmil	M-254	4	200	B-106	
	250 kcmil	M-255	4	150	B-106	
	4/0	M-256	4	150	B-106	
	3/0	M-257	4	150	B-106	
	2/0	M-258	4	90	B-106	
	1/0	M-259	4	90	B-106	
	#1	M-260	4	90	B-106	
	#2	M-261	4	90	B-106	
	350 kcmil	350 kcmil	M-262	4	200	B-106
		300 kcmil	M-263	4	200	B-106
250 kcmil		M-264	4	200	B-106	
4/0		M-265	4	150	B-106	
3/0		M-266	4	150	B-106	
2/0		M-267	4	90	B-106	
1/0		M-268	4	90	B-106	
#1		M-269	4	90	B-106	
#2		M-270	4	90	B-106	
500 kcmil		500 kcmil	M-280	4	2-150	B-106
	350 kcmil	M-282	4	200	B-106	
	300 kcmil	M-283	4	200	B-106	
	250 kcmil	M-284	4	200	B-106	
	4/0	M-285	4	150	B-106	
	2/0	M-286	4	90	B-106	
	1/0	M-287	4	90	B-106	
	#1	M-288	4	90	B-106	
	#2	M-289	4	90	B-106	
	750 kcmil	750 kcmil	M-290	5	500	B-107
500 kcmil		M-291	5	2-200	B-107	
350 kcmil		M-293	4	250	B-106	
300 kcmil		M-294	4	200	B-106	
250 kcmil		M-295	4	200	B-106	
4/0		M-296	4	150	B-106	
2/0		M-297	4	150	B-106	
1/0		M-298	4	150	B-106	

NOTES:

- For sizes not listed, contact BURNDY®
- Molds listed are for concentric stranded cable; add suffix "-S" to mold number for solid conductors
- For heavy duty molds, molds with wear plates or molds for Copperweld® cable, contact BURNDY®
- For expedited service, contact BURNDY®

Required Tools:

Handle Clamps - see chart for correct handle catalog number

Recommended Accessories:

38-0309-00 Flint Ignitor; 38-3922-00 Mold Cleaning Brush; 38-0135-00 Cable Cleaning Brush; 38-0330-00 Cable Clamp

Type CC-4 Molds

Horizontal to Horizontal Cable Cross

Type CC-4 Molds are used to join two horizontal cables at right angles. One cable is cut and the other is a through run. Size range is #6 through 500 kcmil solid or concentric stranded copper conductors. Contact BURNDY® for information on molds for conductors not listed below.

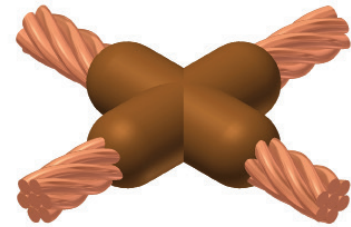

Cable		Mold Number	Price Key	Weld Metal	Handle Clamps
Run	Tap				
#4	#4	M-423	4	45	B-106
#3	#3	M-424	4	45	B-106
#2	#2	M-425	4	65	B-106
	#4	M-426	4	65	B-106
#1	#1	M-427	4	65	B-106
	#2	M-428	4	65	B-106
	#4	M-429	4	65	B-106
1/0	1/0	M-430	4	90	B-106
	#1	M-431	4	90	B-106
	#2	M-432	4	90	B-106
2/0	#4	M-433	4	90	B-106
	2/0	M-434	4	115	B-106
	1/0	M-435	4	115	B-106
	#1	M-436	4	115	B-106
3/0	#2	M-437	4	115	B-106
	3/0	M-438	4	150	B-106
	2/0	M-439	4	150	B-106
	1/0	M-440	4	115	B-106
4/0	#1	M-441	4	115	B-106
	#2	M-442	4	115	B-106
	4/0	M-443	4	200	B-106
	3/0	M-444	4	200	B-106
250 kcmil	2/0	M-445	4	150	B-106
	1/0	M-446	4	150	B-106
	#1	M-447	4	115	B-106
	#2	M-448	4	115	B-106
250 kcmil	250 kcmil	M-449	4	200	B-106
	4/0	M-450	4	200	B-106
	3/0	M-451	4	200	B-106
250 kcmil	2/0	M-452	4	150	B-106
	1/0	M-453	4	150	B-106
	#1	M-454	4	115	B-106
250 kcmil	#2	M-455	4	115	B-106

Cable		Mold Number	Price Key	Weld Metal	Handle Clamps
Run	Tap				
300 kcmil	300 kcmil	M-456	4	250	B-106
	250 kcmil	M-457	4	250	B-106
	4/0	M-458	4	200	B-106
	3/0	M-459	4	200	B-106
	2/0	M-460	4	150	B-106
	1/0	M-461	4	150	B-106
	#1	M-462	4	115	B-106
	#2	M-463	4	115	B-106
	350 kcmil	350 kcmil	M-464	4	250
300 kcmil		M-465	4	250	B-106
250 kcmil		M-466	4	250	B-106
4/0		M-467	4	200	B-106
3/0		M-468	4	200	B-106
2/0		M-469	4	200	B-106
1/0		M-470	4	200	B-106
#1		M-471	4	150	B-106
#2		M-472	4	150	B-106
500 kcmil	500 kcmil	M-483	5	500	B-107
	350 kcmil	M-485	5	2-200	B-107
	300 kcmil	M-486	5	2-200	B-107
	250 kcmil	M-487	5	2-150	B-107
	4/0	M-488	5	2-150	B-107
	3/0	M-489	5	2-150	B-107
	2/0	M-490	4	250	B-106
	1/0	M-491	4	250	B-106
	#1	M-492	4	200	B-106
	#2	M-493	4	200	B-106

NOTES:

- For sizes not listed, contact BURNDY®
- Molds listed are for concentric stranded cable; add suffix "-S" to mold number for solid conductors
- For heavy duty molds, molds with wear plates or molds for Copperweld® cable, contact BURNDY®
- For expedited service, contact BURNDY®

Required Tools:

Handle Clamps - see chart for correct handle catalog number

Recommended Accessories:

38-0309-00 Flint Ignitor; 38-3922-00 Mold Cleaning Brush; 38-0135-00 Cable Cleaning Brush; 38-0330-00 Cable Clamp

Type CC-11 Molds Horizontal to Horizontal Cable Cross

Type CC-11 Molds are used to join uncut horizontal cables at right angles to each other. Size range is #6 through 500 kcmil solid or concentric stranded copper conductors. Contact BURNDY[®] for information on molds for conductors not listed below.

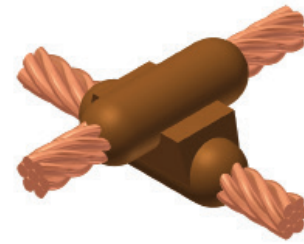

Cable		Mold Number	Price Key	Weld Metal	Handle Clamps
Run	Tap				
#6	#6	M-5432	19	45	Incl.
#4	#4	M-2687	4	65	B-106
#2	#2	M-2689	4	90	B-106
	#4	M-2690	4	65	B-106
#1	#1	M-2691	4	115	B-106
	#2	M-2692	4	90	B-106
	#4	M-2693	4	90	B-106
1/0	1/0	M-2694	22	150	B-106
	#1	M-2695	22	150	B-106
	#2	M-2696	22	115	B-106
	#4	M-2697	22	115	B-106
2/0	2/0	M-2698	22	200	B-106
	1/0	M-2699	22	200	B-106
	#1	M-2700	22	150	B-106
	#2	M-2701	22	150	B-106
3/0	3/0	M-2702	22	250	B-106
	2/0	M-2703	22	200	B-106
	1/0	M-2704	22	200	B-106
	#1	M-2705	22	150	B-106
	#2	M-2706	22	150	B-106
4/0	4/0	M-2707	22	250	B-106
	3/0	M-2708	22	250	B-106
	2/0	M-2709	22	200	B-106
	1/0	M-2710	22	200	B-106
	#1	M-2711	22	150	B-106
	#2	M-2712	22	150	B-106

Cable		Mold Number	Price Key	Weld Metal	Handle Clamps
Run	Tap				
250 kcmil	250 kcmil	M-2713	22	2-150	B-106
	4/0	M-2714	22	2-150	B-106
	3/0	M-2715	22	2-150	B-106
	2/0	M-2716	22	250	B-106
	1/0	M-2717	22	150	B-106
	#1	M-2718	22	200	B-106
	#2	M-2719	22	150	B-106
500 kcmil	500 kcmil	M-2747	23	3-250	B-107
	250 kcmil	M-2751	23	500	B-107
	4/0	M-2752	23	500	B-107
	3/0	M-2753	23	500	B-107
	2/0	M-2754	23	2-200	B-107
	1/0	M-2755	22	2-150	B-106
	#1	M-2756	22	250	B-106
	#2	M-2757	22	250	B-106

NOTES:

- For sizes not listed, contact BURNDY[®]
- Molds listed are for concentric stranded cable; add suffix "-S" to mold number for solid conductors
- For heavy duty molds, molds with wear plates or molds for Copperweld[®] cable, contact BURNDY[®]
- For expedited service, contact BURNDY[®]

Required Tools:

Handle Clamps - see chart for correct handle catalog number

Recommended Accessories:

38-0309-00 Flint Ignitor; 38-3922-00 Mold Cleaning Brush; 38-0135-00 Cable Cleaning Brush; 38-0330-00 Cable Clamp

Type CC-6 Molds

Horizontal Parallel Tap

Type CC-6 Molds are used to join horizontal parallel tap to run connections. The tap cable is over the run cable. Size range is #6 through 4/0 solid or concentric stranded copper conductors. Contact BURNDY® for information on molds for conductors not listed below.

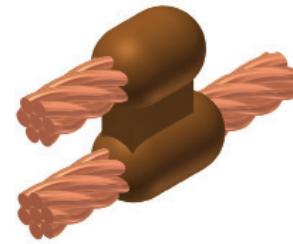

Cable		Mold Number	Price Key	Weld Metal	Handle Clamps
Run	Tap				
#6 Sol	#6 Sol	M-1270	4	25	B-106
#6	#6	M-1271	4	25	B-106
#4	#4	M-1272	4	32	B-106
	#6	M-1273	4	32	B-106
	#6 Sol	M-1274	4	32	B-106
	#8 Sol	M-1275	4	32	B-106
#2	#2	M-1276	4	65	B-106
	#4	M-1277	4	45	B-106
	#6	M-1278	4	32	B-106
	#6 Sol	M-1279	4	32	B-106
#1	#8 Sol	M-1280	4	32	B-106
	#1	M-1281	4	65	B-106
	#2	M-1282	4	65	B-106
	#4	M-1283	4	45	B-106
#1	#6	M-1284	4	45	B-106
	#6 Sol	M-1285	4	45	B-106
	#8 Sol	M-1286	4	45	B-106
	1/0	M-1287	4	90	B-106
	#1	M-1288	4	90	B-106
	#2	M-1289	4	65	B-106
1/0	#4	M-1290	4	65	B-106
	#6	M-1291	4	45	B-106
	#6 Sol	M-1292	4	45	B-106
	#8 Sol	M-1293	4	45	B-106

Cable		Mold Number	Price Key	Weld Metal	Handle Clamps
Run	Tap				
2/0	2/0	M-1294	4	115	B-106
	1/0	M-1295	4	115	B-106
	#1	M-1296	4	90	B-106
	#2	M-1297	4	90	B-106
	#4	M-1298	4	65	B-106
	#6	M-1299	4	65	B-106
	#6 Sol	M-1300	4	65	B-106
	#8 Sol	M-1301	4	65	B-106
	4/0	4/0	M-1302	4	150
2/0		M-1303	4	115	B-106
1/0		M-1304	4	115	B-106
#1		M-1305	4	115	B-106
#2		M-1306	4	115	B-106
#4		M-1307	4	90	B-106
#6		M-1308	4	90	B-106
#6 Sol		M-1309	4	90	B-106
#8 Sol		M-1310	4	90	B-106

NOTES:

- For sizes not listed, contact BURNDY®
- Molds listed are for concentric stranded cable; add suffix "-S" to mold number for solid conductors
- For heavy duty molds, molds with wear plates or molds for Copperweld® cable, contact BURNDY®
- For expedited service, contact BURNDY®

Required Tools:

Handle Clamps - see chart for correct handle catalog number

Recommended Accessories:

38-0309-00 Flint Ignitor; 38-3922-00 Mold Cleaning Brush; 38-0135-00 Cable Cleaning Brush; 38-0330-00 Cable Clamp

Type CC-14 Molds

Horizontal Parallel through Cables

Type CC-14 Molds are used to join horizontal parallel through run cables. Cables run side by side in the mold. Size range is #8 through #6 solid or concentric stranded copper conductors. Contact BURNDY® for information on molds for conductors not listed.

NOTES:

- For sizes not listed, contact BURNDY®
- Molds listed are for concentric stranded cable; add suffix "-S" to mold number for solid conductors
- For heavy duty molds, molds with wear plates or molds for Copperweld® cable, contact BURNDY®
- For expedited service, contact BURNDY®
- Sold complete with handles

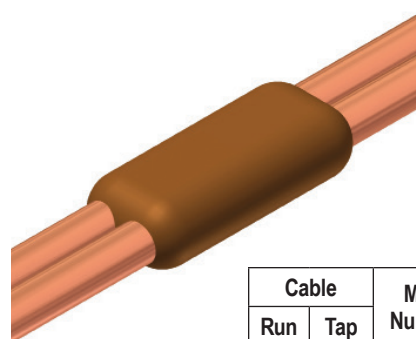

Cable		Mold Number	Price Key	Weld Metal
Run	Tap			
#8	#8	M-5709	18	15
#6	#6	M-5618	18	25

Type CC-7 Molds Horizontal Parallel through Cables

Type CC-7 Type Molds are used to join horizontal parallel through run cables. One cable runs above the other cable in the mold. Size range is #6 through 4/0 solid or concentric stranded copper conductors. Contact BURNDY® for information on molds for conductors not listed below.

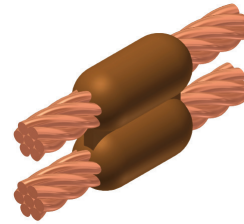

Cable		Mold Number	Price Key	Weld Metal	Handle Clamps
Run	Tap				
#4	#4	M-1311	4	32	B-106
	#6	M-5627	4	32	B-106
	#6 Sol	M-8882	4	32	B-106
	#8	M-5629	4	32	B-106
	#8 Sol	M-5630	4	32	B-106
#2	#2	M-1313	4	65	B-106
	#4	M-1314	4	65	B-106
	#6	M-5631	4	45	B-106
	#6 Sol	M-5632	4	45	B-106
	#8	M-5634	4	45	B-106
	#8 Sol	M-5635	4	45	B-106
#1	#1	M-1315	4	65	B-106
	#2	M-1316	4	65	B-106
	#4	M-1317	4	65	B-106
	#6	M-5636	4	65	B-106
	#6 Sol	M-5637	4	65	B-106
	#8	M-5638	4	45	B-106
	#8 Sol	M-5639	4	45	B-106
1/0	1/0	M-1318	4	90	B-106
	#1	M-1319	4	65	B-106
	#2	M-1320	4	65	B-106
	#4	M-1321	4	65	B-106
	#6	M-5642	4	65	B-106
	#6 Sol	M-1208	4	65	B-106
	#8	M-5644	4	65	B-106
	#8 Sol	M-5645	4	65	B-106

Cable		Mold Number	Price Key	Weld Metal	Handle Clamps
Run	Tap				
2/0	2/0	M-1322	4	115	B-106
	1/0	M-1323	4	115	B-106
	#1	M-1324	4	90	B-106
	#2	M-1325	4	90	B-106
	#4	M-5659	4	90	B-106
	#6	M-5342	4	90	B-106
	#6 Sol	M-5652	4	90	B-106
	#8	M-5668	4	65	B-106
	#8 Sol	M-5943	4	65	B-106
3/0	3/0	M-1326	4	150	B-106
	2/0	M-1327	4	150	B-106
	1/0	M-1328	4	115	B-106
	#1	M-1329	4	115	B-106
	#2	M-1330	4	115	B-106
	#4	M-6046	4	115	B-106
	#6	M-5676	4	90	B-106
	#6 Sol	M-5679	4	90	B-106
	#8	M-5680	4	90	B-106
	#8 Sol	M-5682	4	90	B-106
4/0	4/0	M-1331	4	200	B-106
	3/0	M-1332	4	200	B-106
	2/0	M-1333	4	150	B-106
	1/0	M-1334	4	150	B-106
	#1	M-1335	4	150	B-106
	#2	M-1336	4	150	B-106
	#4	M-5340	4	150	B-106
	#6	M-5684	4	90	B-106
	#6 Sol	M-6552	4	90	B-106
	#8	M-5686	4	90	B-106
	#8 Sol	M-5688	4	90	B-106

NOTES:

- For sizes not listed, contact BURNDY®
- Molds listed are for concentric stranded cable; add suffix "-S" to mold number for solid conductors
- For heavy duty molds, molds with wear plates or molds for Copperweld® cable, contact BURNDY®
- For expedited service, contact BURNDY®

Required Tools:

Handle Clamps - see chart for correct handle catalog number

Recommended Accessories:

38-0309-00 Flint Ignitor; 38-3922-00 Mold Cleaning Brush; 38-0135-00 Cable Cleaning Brush; 38-0330-00 Cable Clamp

Type CR-1 Molds Horizontal Cable Terminal to Ground Rod

Type CR-1 Molds are used to terminate horizontal copper cable at the top of a vertical ground rod. Size range is #6 through 1000 kcmil solid or concentric stranded copper conductors; 1/2" through 1" for the ground rod. Contact BURNDY® for information on molds for conductors not listed below.

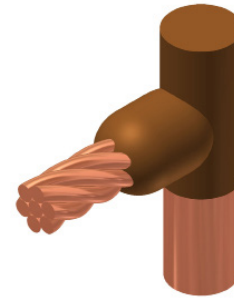

Cable		Mold Number	Price Key	Weld Metal	Handle Clamps
Grd Rod	Tap				
1/2"	#6	M-8402	18 ①	25	Incl.
	#4	M-8403	18 ①	25	Incl.
	#2	M-495	4	65	B-106
	#1	M-496	4	65	B-106
	1/0	M-497	4	90	B-106
	2/0	M-498	4	90	B-106
	3/0	M-499	4	90	B-106
	4/0	M-500	4	90	B-106
	250 kcmil	M-501	4	90	B-106
	300 kcmil	M-502	4	90	B-106
5/8"	#6	M-8414	18 ①	32	Incl.
	#4	M-8415	18 ①	32	Incl.
	#2	M-503	4	65	B-106
	#1	M-504	4	65	B-106
	1/0	M-505	4	90	B-106
	2/0	M-506	4	90	B-106
	3/0	M-507	4	90	B-106
	4/0	M-508	4	90	B-106
	250 kcmil	M-509	4	90	B-106
	300 kcmil	M-510	4	115	B-106
	350 kcmil	M-511	4	115	B-106
	500 kcmil	M-513	4	150	B-106

① 38-0309-00 Flint ignitor included

Cable		Mold Number	Price Key	Weld Metal	Handle Clamps
Grd Rod	Tap				
3/4"	#6	M-8422	18 ①	32	Incl.
	#4	M-8426	19 ①	45	Incl.
	#2	M-5781	4	90	B-106
	#1	M-514	4	90	B-106
	1/0	M-515	4	90	B-106
	2/0	M-516	4	90	B-106
	3/0	M-517	4	90	B-106
	4/0	M-518	4	90	B-106
	250 kcmil	M-519	4	90	B-106
	300 kcmil	M-520	4	115	B-106
	350 kcmil	M-521	4	115	B-106
	500 kcmil	M-523	4	150	B-106
	750 kcmil	M-524	4	250	B-106
	1"	1/0	M-525	4	150
2/0		M-526	4	150	B-106
3/0		M-527	4	150	B-106
4/0		M-528	4	150	B-106
250 kcmil		M-529	4	150	B-106
300 kcmil		M-530	4	200	B-106
350 kcmil		M-531	4	200	B-106
500 kcmil		M-533	4	200	B-106
750 kcmil		M-534	4	250	B-106
1000 kcmil		M-535	5	2-150	B-106

NOTES:

- For sizes not listed, contact BURNDY®
- Molds listed are for concentric stranded cable; add suffix "-S" to mold number for solid conductors
- For heavy duty molds, molds with wear plates or molds for Copperweld® cable, contact BURNDY®
- For expedited service, contact BURNDY®

Required Tools:

Handle Clamps - see chart for correct handle catalog number

Recommended Accessories:

38-0309-00 Flint Ignitor; 38-3922-00 Mold Cleaning Brush; 38-0135-00 Cable Cleaning Brush; 38-0330-00 Cable Clamp

Type CR-2 Molds Horizontal Cable to Ground Rod

Type CR-2 Molds are used to join horizontal through copper cable to the top of a vertical ground rod. Size range is #6 through 1000 kcmil solid or concentric stranded copper conductors; 1/2" through 1" for the ground rod. Contact BURNDY® for information on molds for conductors not listed below.

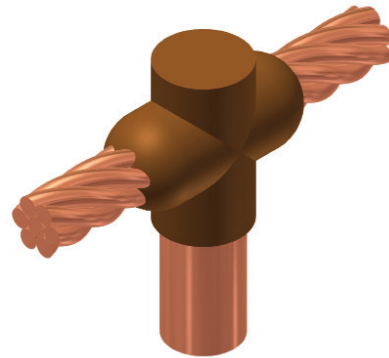

Cable		Mold Number	Price Key	Weld Metal	Handle Clamps
Grd Rod	Tap				
1/2"	#6	M-8434	18 ①	32	Incl.
	#4	M-8435	18 ①	32	Incl.
	#2	M-537	4	90	B-106
	#1	M-538	4	90	B-106
	1/0	M-539	4	90	B-106
	2/0	M-540	4	90	B-106
	3/0	M-541	4	115	B-106
	4/0	M-542	4	115	B-106
	250 kcmil	M-543	4	150	B-106
	300 kcmil	M-544	4	200	B-106
	5/8"	#6	M-8441	18 ①	32
#4		M-8442	18 ①	32	Incl.
#2		M-545	4	90	B-106
#1		M-546	4	90	B-106
1/0		M-547	4	90	B-106
2/0		M-548	4	115	B-106
3/0		M-549	4	115	B-106
4/0		M-550	4	115	B-106
250 kcmil		M-551	4	150	B-106
300 kcmil		M-552	4	200	B-106
350 kcmil		M-553	4	200	B-106
500 kcmil		M-555	4	250	B-106

Cable		Mold Number	Price Key	Weld Metal	Handle Clamps	
Grd Rod	Tap					
3/4"	#6	M-8452	19 ①	45	Incl.	
	#4	M-8454	19 ①	65	Incl.	
	#2	M-556	4	90	B-106	
	#1	M-557	4	90	B-106	
	1/0	M-558	4	115	B-106	
	2/0	M-559	4	115	B-106	
	3/0	M-560	4	115	B-106	
	4/0	M-561	4	115	B-106	
	250 kcmil	M-562	4	150	B-106	
	300 kcmil	M-563	4	200	B-106	
	350 kcmil	M-564	4	200	B-106	
	500 kcmil	M-566	4	250	B-106	
	750 kcmil	M-567	5	2-200	B-107	
	1"	1/0	M-569	4	150	B-106
		2/0	M-570	4	150	B-106
		3/0	M-571	4	150	B-106
4/0		M-572	4	150	B-106	
250 kcmil		M-573	4	200	B-106	
300 kcmil		M-574	4	200	B-106	
350 kcmil		M-575	4	200	B-106	
500 kcmil		M-577	4	250	B-106	
750 kcmil		M-578	5	2-200	B-107	
1000 kcmil		M-579	5	500	B-107	

① 38-0309-00 Flint ignitor included

NOTES:

- For sizes not listed, contact BURNDY®
- Molds listed are for concentric stranded cable; add suffix "-S" to mold number for solid conductors
- For heavy duty molds, molds with wear plates or molds for Copperweld® cable, contact BURNDY®
- For expedited service, contact BURNDY®

Required Tools:

Handle Clamps - see chart for correct handle catalog number

Recommended Accessories:

38-0309-00 Flint Ignitor; 38-3922-00 Mold Cleaning Brush; 38-0135-00 Cable Cleaning Brush; 38-0330-00 Cable Clamp

Type CR-3 Molds Horizontal Through Cable to Ground Rod

Type CR-3 Molds are used to join horizontal through run cable to the side of a vertical ground rod. Size range is #6 through 1000 kcmil solid or concentric stranded copper conductors; 1/2" through 1" for the ground rod. Contact BURNDY® for information on molds for conductors not listed below.

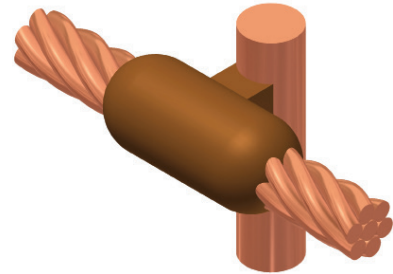

Cable		Mold Number	Price Key	Weld Metal	Handle Clamps
Grd Rod	Tap				
1/2"	#6	M-5321	24	65	B-106
	#4	M-2154	24	90	B-106
	#2	M-2155	24	90	B-106
	#1	M-2156	24	115	B-106
	1/0	M-1581	24	115	B-106
	2/0	M-1582	24	115	B-106
	4/0	M-1583	24	150	B-106
	250 kcmil	M-1584	24	150	B-106
5/8"	#6	M-5660	24	65	B-106
	#4	M-2157	24	90	B-106
	#2	M-2158	24	90	B-106
	#1	M-2159	24	115	B-106
	1/0	M-1586	24	115	B-106
	2/0	M-1587	24	115	B-106
	4/0	M-1588	24	150	B-106
	250 kcmil	M-1589	24	150	B-106
500 kcmil	M-1593	13	2-200	B-107	

Cable		Mold Number	Price Key	Weld Metal	Handle Clamps
Grd Rod	Tap				
3/4"	#6	M-6630	24	65	B-106
	#4	M-2160	24	90	B-106
	#2	M-2161	24	90	B-106
	#1	M-2162	24	115	B-106
	1/0	M-1594	24	115	B-106
	2/0	M-1595	24	115	B-106
	4/0	M-1596	24	150	B-106
	250 kcmil	M-1597	24	200	B-106
	500 kcmil	M-1601	13	500	B-107
	750 kcmil	M-1602	13	3-250	B-107
1"	#6	M-6906	24	90	B-106
	#4	M-2163	24	90	B-106
	#2	M-2164	24	90	B-106
	#1	M-2165	24	115	B-106
	1/0	M-1603	24	115	B-106
	2/0	M-1604	24	115	B-106
	4/0	M-1605	24	150	B-106
	250 kcmil	M-1606	24	200	B-106
	500 kcmil	M-1610	13	500	B-107
	750 kcmil	M-1611	13	3-250	B-107

NOTES:

- For sizes not listed, contact BURNDY®
- Molds listed are for concentric stranded cable; add suffix "-S" to mold number for solid conductors
- For heavy duty molds, molds with wear plates or molds for Copperweld® cable, contact BURNDY®
- For expedited service, contact BURNDY®

Required Tools:
Handle Clamps - see chart for correct handle catalog number

Recommended Accessories:
38-0309-00 Flint Ignitor; 38-3922-00 Mold Cleaning Brush; 38-0135-00 Cable Cleaning Brush; 38-0330-00 Cable Clamp

Type CR-17 Molds

Horizontal Run and Tap Cables to Ground Rod

Type CR-17 Molds are used to join horizontal run and tap cables to the top of a vertical ground rod. Size range is #4 through 750 kcmil solid or concentric stranded copper conductors; 1/2" through 1" for the ground rod. Contact BURNDY[®] for information on molds for conductors not listed below.

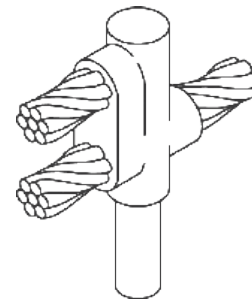

Cable		Mold Number	Price Key	Weld Metal	Handle Clamps
Grd Rod	Tap				
1/2"	#4	M-5416	4	90	B-106
	#2	M-6165	4	90	B-106
	#1	M-5830	4	90	B-106
	1/0	M-5940	4	115	B-106
	2/0	M-5850	4	150	B-106
	3/0	M-5833	4	200	B-106
	4/0	M-5380	4	200	B-106
5/8"	#4	M-5972	4	90	B-106
	#2	M-5935	4	115	B-106
	#1	M-5699	4	115	B-106
	1/0	M-5746	4	150	B-106
	2/0	M-5963	4	200	B-106
	3/0	M-5734	4	250	B-106
	4/0	M-5732	4	250	B-106
	250 kcmil	M-5722	5	2-150	B-107
3/4"	#4	M-5698	4	90	B-106
	#2	M-5294	4	115	B-106
	#1	M-5390	4	115	B-106
	1/0	M-6025	4	150	B-106
	2/0	M-5738	4	200	B-106
	3/0	M-6003	4	250	B-106
	4/0	M-2566	4	250	B-106
	250 kcmil	M-5904	5	2-150	B-107
	300 kcmil	M-5857	5	2-200	B-107
	350 kcmil	M-5777	5	2-200	B-107
	500 kcmil	M-5961	5	3-200	B-107

Cable		Mold Number	Price Key	Weld Metal	Handle Clamps
Grd Rod	Tap				
1"	#4	M-5556	4	115	B-106
	#2	M-5555	4	150	B-106
	#1	M-6048	4	150	B-106
	1/0	M-5992	4	200	B-106
	2/0	M-5877	4	250	B-106
	3/0	M-5821	5	2-150	B-107
	4/0	M-5820	5	2-150	B-107
	250 kcmil	M-5807	5	2-200	B-107
	300 kcmil	M-5803	5	500	B-107
	350 kcmil	M-5561	5	500	B-107
	500 kcmil	M-5515	6	3-250	B-107
	750 kcmil	M-5513	6	2-500	B-107

NOTES:

- For sizes not listed, contact BURNDY[®]
- Molds listed are for concentric stranded cable; add suffix "-S" to mold number for solid conductors
- For heavy duty molds, molds with wear plates or molds for Copperweld[®] cable, contact BURNDY[®]
- For expedited service, contact BURNDY[®]

Required Tools:

Handle Clamps - see chart for correct handle catalog number

Recommended Accessories:

38-0309-00 Flint Ignitor; 38-3922-00 Mold Cleaning Brush; 38-0135-00 Cable Cleaning Brush; 38-0330-00 Cable Clamp

Type CR-24 Molds

Horizontal Parallel Run Cables to Ground Rod

Type CR-24 Molds are used to join horizontal parallel cables to the top of a vertical ground rod. Size range is #4 through 750 kcmil solid or concentric stranded copper conductors; 1/2" through 1" for the ground rod. Contact BURNDY® for information on molds for conductors not listed below.

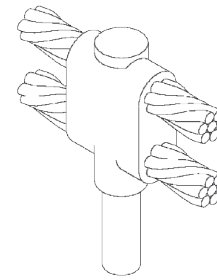

Cable		Mold Number	Price Key	Weld Metal	Handle Clamps
Grd Rod Size	Tap				
1/2"	#4	M-5640	4	115	B-106
	#2	M-5667	4	115	B-106
	#1	M-6002	4	115	B-106
	1/0	M-5767	4	150	B-106
	2/0	M-5604	4	200	B-106
	3/0	M-5560	4	250	B-106
	4/0	M-6766	4	250	B-106
	5/8"	#4	M-6208	4	115
#2		M-5702	4	150	B-106
#1		M-5517	4	150	B-106
1/0		M-5573	4	200	B-106
2/0		M-8451	4	250	B-106
3/0		M-2510	5	2-150	B-107
4/0		M-5428	5	2-150	B-107
250 kcmil		M-1212	5	2-200	B-107
300 kcmil		M-2084	5	500	B-107
350 kcmil		M-2558	5	500	B-107
500 kcmil		M-2450	5	3-250	B-107
3/4"		#4	M-8011	4	115
	#2	M-2320	4	150	B-106
	#1	M-2235	4	150	B-106
	1/0	M-6051	4	200	B-106
	2/0	M-8802	4	250	B-106
	3/0	M-8726	5	2-150	B-107
	4/0	M-5677	5	2-150	B-107
	250 kcmil	M-8461	5	2-200	B-107
	300 kcmil	M-8428	5	500	B-107
	350 kcmil	M-8294	5	500	B-107
	500 kcmil	M-8214	5	3-250	B-107
	750 kcmil	M-8027	6	2-500	B-107

Cable		Mold Number	Price Key	Weld Metal	Handle Clamps
Grd Rod Size	Tap				
1"	#4	M-5330	4	150	B-106
	#2	M-5332	4	200	B-106
	#1	M-5333	4	200	B-106
	1/0	M-5334	4	250	B-106
	2/0	M-5335	5	2-150	B-107
	3/0	M-5336	5	2-200	B-107
	4/0	M-5337	5	2-200	B-107
	250 kcmil	M-5338	5	500	B-107
	300 kcmil	M-5341	5	3-200	B-107
	350 kcmil	M-5351	5	3-200	B-107
	500 kcmil	M-5352	6	2-500	B-107
	750 kcmil	M-5353	6	5-250	B-107

NOTES:

- For sizes not listed, contact BURNDY®
- Molds listed are for concentric stranded cable; add suffix "-S" to mold number for solid conductors
- For heavy duty molds, molds with wear plates or molds for Copperweld® cable, contact BURNDY®
- For expedited service, contact BURNDY®

Required Tools:

Handle Clamps - see chart for correct handle catalog number

Recommended Accessories:

38-0309-00 Flint Ignitor; 38-3922-00 Mold Cleaning Brush; 38-0135-00 Cable Cleaning Brush; 38-0330-00 Cable Clamp

Exothermic Grounding

thermOweld®, Type CS-1 and CS-8 Molds;
Horizontal Cable to Horizontal Steel

Type CS-1 Molds

Horizontal Cable to Horizontal Steel Surface

Type CS-1 Molds are used to terminate a horizontal copper cable to any horizontal steel surface. Note that the cable is OFF the surface. Size range is 1/0 through 1000 kcmil solid or concentric stranded copper conductors. Contact BURNDY® for information on molds for conductors not listed below.

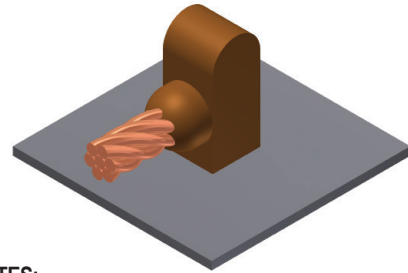

Cable Size	Mold Number	Price Key	Weld Metal	Handle Clamps
1/0	M-644	4	90	B-106
2/0	M-645	4	90	B-106
3/0	M-646	4	115	B-106
4/0	M-647	4	115	B-106
250 kcmil	M-648	4	115	B-106
300 kcmil	M-649	4	150	B-106
350 kcmil	M-650	4	200	B-106
500 kcmil	M-652	4	200	B-106
750 kcmil	M-653	5	2-150	B-106
1000 kcmil	M-654	5	2-200	B-107

NOTES:

- For sizes not listed, contact BURNDY®
- Molds listed are for concentric stranded cable; add suffix "-S" to mold number for solid conductors
- For heavy duty molds, molds with wear plates or molds for Copperweld® cable, contact BURNDY®
- For expedited service, contact BURNDY®

Required Tools:

Handle Clamps - see chart for correct handle catalog number

Recommended Accessories:

38-0309-00 Flint Ignitor; **38-3922-00** Mold Cleaning Brush;
38-0135-00 Cable Cleaning Brush;
38-0330-00 Cable Clamp

Type CS-8 Molds

Horizontal Cable to Horizontal Steel Surface

Type CS-8 Molds are used to terminate a horizontal copper cable to any horizontal steel surface. Note that the cable is ON the surface. Size range is #6 through 1000 kcmil solid or concentric stranded copper conductors. Contact BURNDY® for information on molds for conductors not listed below.

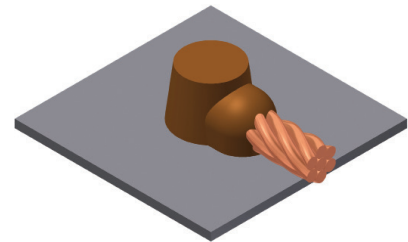

Cable Size	Mold Number	Price Key	Weld Metal	Handle Clamps
#6	M-628	3 ①	45	Incl.
#4	M-629	3 ①	45	Incl.
#2	M-630	3 ①	45	Incl.
#1	M-631	3 ①	65	Incl.
1/0	M-7146	4	90	B-106
2/0	M-7075	4	90	B-106
3/0	M-2199	4	115	B-106
4/0	M-6114	4	115	B-106
250 kcmil	M-2200	4	115	B-106
300 kcmil	M-2506	4	150	B-106
350 kcmil	M-2507	4	200	B-106
500 kcmil	M-2509	4	200	B-106
750 kcmil	M-2542	5	2-150	B-107
1000 kcmil	M-2511	5	2-200	B-107

NOTES:

- For sizes not listed, contact BURNDY®
- Molds listed are for concentric stranded cable; add suffix "-S" to mold number for solid conductors
- For heavy duty molds, molds with wear plates or molds for Copperweld® cable, contact BURNDY®
- For expedited service, contact BURNDY®

Required Tools:

Handle Clamps - see chart for correct handle catalog number

Recommended Accessories:

38-0309-00 Flint Ignitor;
38-3922-00 Mold Cleaning Brush;
38-0135-00 Cable Cleaning Brush;
38-0330-00 Cable Clamp

① **38-0309-00** Flint ignitor included

Type CS-2 Molds

Horizontal Through Cable to Horizontal Steel Surface

Type CS-2 Molds are used to join horizontal through copper cable to any horizontal steel surface. Note the cable is OFF the surface. Size range is 1/0 through 1000 kcmil solid or concentric stranded copper conductors. Contact BURNDY® for information on molds for conductors not listed below.

Cable Size	Mold Number	Price Key	Weld Metal	Handle Clamps
1/0	M-616	4	90	B-106
2/0	M-617	4	115	B-106
3/0	M-618	4	115	B-106
4/0	M-619	4	150	B-106
250 kcmil	M-620	4	150	B-106
300 kcmil	M-621	4	200	B-106
350 kcmil	M-622	4	250	B-106
500 kcmil	M-624	5	2-150	B-107
750 kcmil	M-625-H	5	3-250	B-107
1000 kcmil	M-626-H	5	2-500	B-107

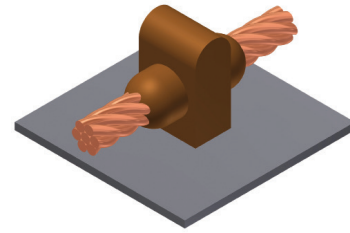

NOTES:

- For sizes not listed, contact BURNDY®
- Molds listed are for concentric stranded cable; add suffix "-S" to mold number for solid conductors
- For heavy duty molds, molds with wear plates or molds for Copperweld® cable, contact BURNDY®
- For expedited service, contact BURNDY®

Required Tools:

Handle Clamps - see chart for correct handle catalog number

Recommended Accessories:

38-0309-00 Flint Ignitor; **38-3922-00** Mold Cleaning Brush; **38-0135-00** Cable Cleaning Brush; **38-0330-00** Cable Clamp

Type CS-9 Molds

Horizontal Through Cable to Horizontal Steel Surface

Type CS-9 Molds are used to join horizontal through copper cable to any horizontal steel surface. Note the cable is ON the surface. Size range is #6 through 500 kcmil solid or concentric stranded copper conductors. Contact BURNDY® for information on molds for conductors not listed below.

Cable Size	Mold Number	Price Key	Weld Metal	Handle Clamps
#6	M-602	3 ①	45	Incl.
#4	M-603	3 ①	45	Incl.
#2	M-604	3 ①	45	Incl.
#1	M-605	3 ①	65	Incl.
1/0	M-8379	4	90	B-106
2/0	M-5331	4	115	B-106
3/0	M-8381	4	115	B-106
4/0	M-7192	4	150	B-106
250 kcmil	M-8413	4	150	B-106
300 kcmil	M-8423	4	200	B-106
350 kcmil	M-8410	4	250	B-106
500 kcmil	M-5065	5	2-150	B-107

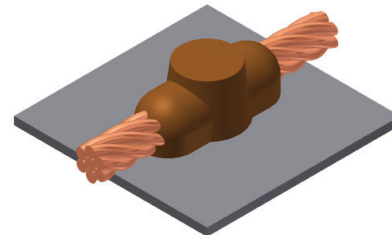

NOTES:

- For sizes not listed, contact BURNDY®
- Molds listed are for concentric stranded cable; add suffix "-S" to mold number for solid conductors
- For heavy duty molds, molds with wear plates or molds for Copperweld® cable, contact BURNDY®
- For expedited service, contact BURNDY®

Required Tools:

Handle Clamps - see chart for correct handle catalog number

Recommended Accessories:

38-0309-00 Flint Ignitor;
38-3922-00 Mold Cleaning Brush;
38-0135-00 Cable Cleaning Brush;
38-0330-00 Cable Clamp

① **38-0309-00** Flint ignitor included

Exothermic Grounding

thermOweld®; Type CS-3
Angular Cable Drop to Vertical Steel

Type CS-3 Molds

Angular Cable Drop to Vertical Steel Surface

Type CS-3 Molds are used to join the end of a copper cable at a 45° angle to a vertical steel surface. Size range is #6 through 1000 kcmil solid or concentric stranded copper conductors. Contact BURNDY® for information on molds for conductors not listed below.

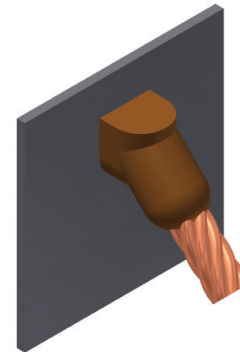

Cable Size	Pipe Size	Mold Number	Price Key	Weld Metal	Handle Clamps
#6	Flat Steel Only	M-585	4	45	B-106
#4	12" & up	M-586 ①	4	45	B-106
#3	Flat Steel Only	M-587	4	45	B-106
#2	12" & up	M-588 ①	4	45	B-106
#1	12" & up	M-589 ①	4	65	B-106
1/0	12" & up	M-590 ①	4	90	B-106
2/0	12" & up	M-591 ①	4	90	B-106
3/0	12" & up	M-592 ①	4	115	B-106
4/0	12" & up	M-593 ①	4	115	B-106
250 kcmil	Flat Steel Only	M-594	4	115	B-106
300 kcmil	Flat Steel Only	M-595	4	150	B-106
350 kcmil	Flat Steel Only	M-596	4	200	B-106
500 kcmil	Flat Steel Only	M-598	4	200	B-106
750 kcmil	Flat Steel Only	M-599	5	2-150	B-106
1000 kcmil	Flat Steel Only	M-600	5	2-200	B-106
#4	1-1/4" to 4"	M-2476	4	45	B-106
#4	4" to 6"	M-2477	4	45	B-106
#4	6" to 10"	M-2478	4	45	B-106
#2 Sol	1-1/4" to 4"	M-9233-S	4	45	B-106
#2 Sol	4" to 6"	M-2480-S	4	45	B-106
#2 Sol	6" to 10"	M-2583-S	4	45	B-106
#2 Sol	12" & up	M-588-S ①	4	45	B-106
#2	1-1/4" to 4"	M-9233	4	45	B-106
#2	4" to 6"	M-2480	4	45	B-106
#2	6" to 10"	M-2583	4	45	B-106
#1	1-1/4" to 4"	M-2482	4	65	B-106
#1	4" to 6"	M-2483	4	65	B-106
#1	6" to 10"	M-2484	4	65	B-106
1/0	1-1/4" to 4"	M-2486	4	90	B-106
1/0	4" to 6"	M-2487	4	90	B-106
1/0	6" to 10"	M-2488	4	90	B-106

Cable Size	Pipe Size	Mold Number	Price Key	Weld Metal	Handle Clamps
2/0	1-1/4" to 4"	M-8833	4	90	B-106
2/0	4" to 6"	M-2490	4	90	B-106
2/0	6" to 10"	M-2491	4	90	B-106
3/0	1-1/4" to 4"	M-2493	4	115	B-106
3/0	4" to 6"	M-2494	4	115	B-106
3/0	6" to 10"	M-2495	4	115	B-106
4/0	1-1/4" to 4"	M-9021	4	115	B-106
4/0	4" to 6"	M-2497	4	115	B-106
4/0	6" to 10"	M-2498	4	115	B-106

① Flat Surface Mold; These items can be used to Flat Steel or to Pipe

NOTES:

- For sizes not listed, contact BURNDY®
- Molds listed are for concentric stranded cable; add suffix "-S" to mold number for solid conductors
- For heavy duty molds, molds with wear plates or molds for Copperweld® cable, contact BURNDY®
- For expedited service, contact BURNDY®

Required Tools:

Handle Clamps - see chart for correct handle catalog number

Recommended Accessories:

- 38-0309-00 Flint Ignitor
- 38-3922-00 Mold Cleaning Brush
- 38-0135-00 Cable Cleaning Brush
- 38-0330-00 Cable Clamp

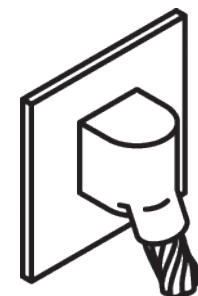

Cable to Flat Steel

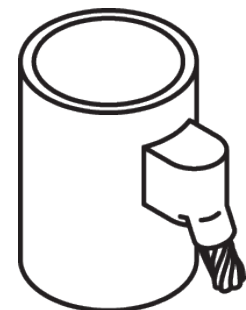

Cable to Pipe

Type CS-23 Molds

Vertical Cable Drop to Vertical Steel Surface

Type CS-23 Molds are used to join vertical cable down to a vertical steel surface. Note that the cable is OFF the surface. Size range is #6 through 500 kcmil solid or concentric stranded copper conductors. Contact BURNDY® for information on molds for conductors not listed below.

Cable Size	Mold Number	Price Key	Weld Metal	Handle Clamps
#6	M-5389	4	45	B-106
#4	M-5359	4	65	B-106
#2	M-2781	4	65	B-106
#1	M-5361	4	90	B-106
1/0	M-2189	4	115	B-106
2/0	M-2540	4	115	B-106
3/0	M-5362	4	150	B-106
4/0	M-8718	4	150	B-106
250 kcmil	M-8165	4	200	B-106
300 kcmil	M-5363	4	200	B-106
350 kcmil	M-9029	4	250	B-106
500 kcmil	M-8512	17	2-150	B-106

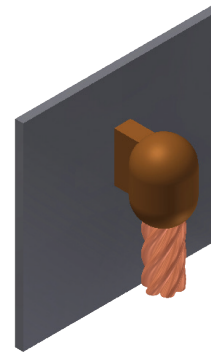

NOTES:

- For sizes not listed, contact BURNDY®
- Molds listed are for concentric stranded cable; add suffix "-S" to mold number for solid conductors
- For heavy duty molds, molds with wear plates or molds for Copperweld® cable, contact BURNDY®
- For expedited service, contact BURNDY®

Required Tools:

Handle Clamps - see chart for correct handle catalog number

Recommended Accessories:

- 38-0309-00 Flint Ignitor;
- 38-3922-00 Mold Cleaning Brush;
- 38-0135-00 Cable Cleaning Brush;
- 38-0330-00 Cable Clamp

Type CS-4 Molds

Vertical Through Cable to Vertical Steel Surface

Type CS-4 Molds are used to join a vertical through copper cable to a vertical steel surface. Note that the cable is OFF the surface. For molds with the cable on the surface, contact BURNDY®. Size range is #6 through 500 kcmil solid or concentric stranded copper conductors. Contact BURNDY® for information on molds for conductors not listed.

Cable Size	Mold Number	Price Key	Weld Metal	Handle Clamps
#6	M-1215	4	90	B-106
#4	M-1216	4	90	B-106
#2	M-1218	4	115	B-106
#1	M-1219	4	115	B-106
1/0	M-1220	17	200	B-106
2/0	M-1221	17	200	B-106
3/0	M-1222	17	250	B-106
4/0	M-1223	17	250	B-106
250 kcmil	M-1224	17	250	B-106
300 kcmil	M-1225-H	6	500	B-107
350 kcmil	M-1226-H	6	3-200	B-107
500 kcmil	M-1228-H	6	3-250	B-107

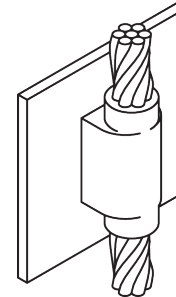

NOTES:

- For sizes not listed, contact BURNDY®
- Molds listed are for concentric stranded cable; add suffix "-S" to mold number for solid conductors
- For heavy duty molds, molds with wear plates or molds for Copperweld® cable, contact BURNDY®
- For expedited service, contact BURNDY®

Required Tools:

Handle Clamps - see chart for correct handle catalog number

Recommended Accessories:

- 38-0309-00 Flint Ignitor;
- 38-3922-00 Mold Cleaning Brush;
- 38-0135-00 Cable Cleaning Brush;
- 38-0330-00 Cable Clamp

Type CS-6 Molds

Horizontal Through Cable to Vertical Steel Surface

Type CS-6 Molds are used to join horizontal through copper cable to a vertical steel surface. Note that the cable is OFF the surface. Size range is #6 through 250 kcmil solid or concentric stranded copper conductors. Contact BURNDY® for information on molds for conductors not listed below.

Cable Size	Mold Number	Price Key	Weld Metal	Handle Clamps
#6	M-1626	4	65	B-106
#4	M-1627	4	65	B-106
#2	M-1628	4	65	B-106
#1	M-1629	4	90	B-106
1/0	M-1630	4	115	B-106
2/0	M-1631	4	115	B-106
3/0	M-1632	4	150	B-106
4/0	M-1633	4	150	B-106
250 kcmil	M-1634	4	150	B-106

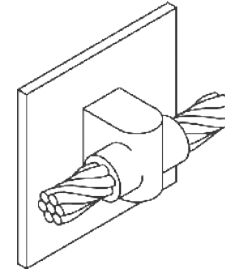

NOTES:

- For sizes not listed, contact BURNDY®
- Molds listed are for concentric stranded cable; add suffix "-S" to mold number for solid conductors
- For heavy duty molds, molds with wear plates or molds for Copperweld® cable, contact BURNDY®
- For expedited service, contact BURNDY®

Required Tools:

Handle Clamps - see chart for correct handle catalog number

Recommended Accessories:

- 38-0309-00 Flint Ignitor
- 38-3922-00 Mold Cleaning Brush
- 38-0135-00 Cable Cleaning Brush
- 38-0330-00 Cable Clamp

Type CS-7 Molds

Overhead Vertical Tap Cable to Vertical Steel Surface

Type CS-7 Molds are used to join an overhead vertical copper conductor drop tap to a vertical steel surface. Size range is #6 through 1000 kcmil solid or concentric stranded copper conductors. Contact BURNDY® for information on molds for conductors not listed below.

Cable Size	Mold Number	Price Key	Weld Metal	Handle Clamps
#6	M-1635	4	65	B-106
#4	M-1636	4	65	B-106
#3	M-1637	4	65	B-106
#2	M-1638	4	65	B-106
#1	M-1639	4	90	B-106
1/0	M-1640	4	150	B-106
2/0	M-1641	4	150	B-106
3/0	M-1642	17	200	B-106
4/0	M-1643	17	200	B-106
250 kcmil	M-1644	17	200	B-106
300 kcmil	M-1645	17	250	B-106
350 kcmil	M-1646	6	2-150	B-107
500 kcmil	M-1648	6	2-200	B-107
750 kcmil	M-1649	6	500	B-107
1000 kcmil	M-1650	6	3-200	B-107

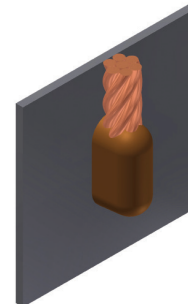

NOTES:

- For sizes not listed, contact BURNDY®
- Molds listed are for concentric stranded cable; add suffix "-S" to mold number for solid conductors
- For heavy duty molds, molds with wear plates or molds for Copperweld® cable, contact BURNDY®
- For expedited service, contact BURNDY®

Required Tools:

Handle Clamps - see chart for correct handle catalog number

Recommended Accessories:

- 38-0309-00 Flint Ignitor
- 38-3922-00 Mold Cleaning Brush
- 38-0135-00 Cable Cleaning Brush
- 38-0330-00 Cable Clamp

Type CS-18 Molds

Horizontal Tap Cable to Vertical Steel Surface

Type CS-18 Molds are used to connect a horizontal conductor to a vertical steel surface. Note that the cable is ON the surface. Size range is #6 through 500 kcmil solid or concentric stranded copper conductors. Contact BURNDY® for information on molds for conductors not listed below.

Cable Size	Mold Number	Price Key	Weld Metal	Handle Clamps
#6	M-5910	4	45	B-106
#4	M-2761	4	45	B-106
#1	M-6060	4	65	B-106
1/0	M-5419	4	90	B-106
2/0	M-2567	4	90	B-106
3/0	M-6072	4	115	B-106
4/0	M-9253	4	115	B-106
250 kcmil	M-2568	4	115	B-106
300 kcmil	M-6061	4	150	B-106
350 kcmil	M-6067	4	200	B-106
500 kcmil	M-8359	4	200	B-106

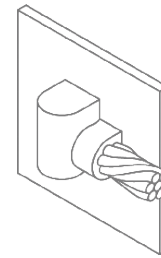

NOTES:

- For sizes not listed, contact BURNDY®
- Molds listed are for concentric stranded cable; add suffix "-S" to mold number for solid conductors
- For heavy duty molds, molds with wear plates or molds for Copperweld® cable, contact BURNDY®
- For expedited service, contact BURNDY®

Required Tools:

Handle Clamps - see chart for correct handle catalog number

Recommended Accessories:

- 38-0309-00 Flint Ignitor;
- 38-3922-00 Mold Cleaning Brush;
- 38-0135-00 Cable Cleaning Brush;
- 38-0330-00 Cable Clamp

Type CS-5 Molds

Horizontal Cable Tap to Horizontal Cast Iron Surface

Type CS-5 Molds are used to join horizontal cable taps to horizontal cast iron surfaces. Note that the cable is ON the surface. Size range is #6 through #1 solid or concentric stranded copper conductors. Contact BURNDY® for information on molds for conductors not listed below.

Cable Size	Mold Number	Price Key	Weld Metal	Handle Clamps
#6 Sol	M-1613	3 ①	2SCI	Incl.
#6	M-1614	3 ①	25CI	Incl.
#4 Sol	M-1615	3 ①	45CI	Incl.
#4	M-1616	3 ①	45CI	Incl.
#2 Sol	M-1617	3 ①	45CI	Incl.
#2	M-1618	3 ①	45CI	Incl.
#1 Sol	M-1619	3 ①	65CI	Incl.
#1	M-1620	3 ①	65CI	Incl.

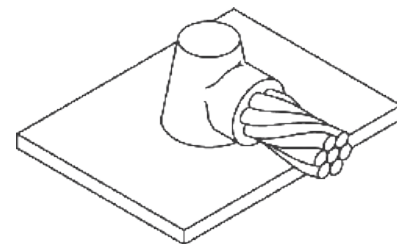

DO NOT use Type CS-5 molds on Soil Pipe (ASTM A74-82). A test weld should be made on a section of pipe being used to determine the possibility of detrimental metallurgical effects.

① 38-0309-00 Flint ignitor included

NOTES:

- For sizes not listed, contact BURNDY®
- Molds listed are for concentric stranded cable; add suffix "-S" to mold number for solid conductors
- For heavy duty molds, molds with wear plates or molds for Copperweld® cable, contact BURNDY®
- For expedited service, contact BURNDY®

Required Tools:

Handle Clamps - see chart for correct handle catalog number

Recommended Accessories:

- 38-0309-00 Flint Ignitor
- 38-3922-00 Mold Cleaning Brush
- 38-0135-00 Cable Cleaning Brush
- 38-0330-00 Cable Clamp

Type CRE-1 Molds Horizontal Parallel Tap to Rebar

Type CRE-1 Molds are recommended for parallel, horizontal connections for solid or concentric stranded conductors #6 through 4/0 joined to reinforcing bars #3 through #6 and larger. The high copper content joint has a higher current carrying capacity than the conductors being joined and is impervious to vibration and moisture. Contact BURNDY® for information on molds for conductors not listed below.

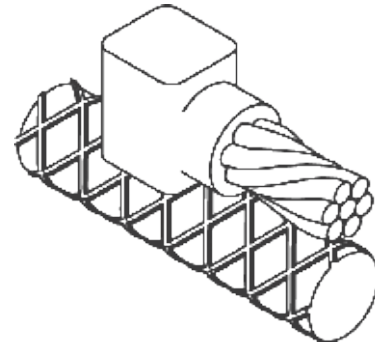

Rebar Size	Cable Size	Mold Number	Packing Material	Price Key	Weld Metal	Handle Clamps
3	#6	M-7500	38-0329-00	4	25	B-106
	#4	M-7501	38-0329-00	4	32	B-106
	#2	M-7502	38-0329-00	4	45	B-106
	#1	M-7503	38-0329-00	4	65	B-106
	1/0	M-7504	38-0329-00	4	90	B-106
	2/0	M-7505	38-0329-00	4	90	B-106
	3/0	M-7506	38-0329-00	4	115	B-106
	4/0	M-7507	38-0329-00	4	115	B-106
4 & Larger	#6	M-7508	38-4061-00	3 ①	25	Incl.
	#4	M-7509	38-4061-00	3 ①	32	Incl.
	#2	M-7510	38-4061-00	3 ①	45	Incl.
	#1	M-7511	38-4061-00	3 ①	65	Incl.
4	1/0	M-7512	38-0329-00	4	90	B-106
	2/0	M-7513	38-0329-00	4	90	B-106
	3/0	M-7514	38-0329-00	4	115	B-106
	4/0	M-7515	38-0329-00	4	115	B-106
5	1/0	M-7520	38-0329-00	4	90	B-106
	2/0	M-7521	38-0329-00	4	90	B-106
	3/0	M-7522	38-0329-00	4	115	B-106
	4/0	M-7523	38-0329-00	4	115	B-106
6 & Larger	1/0	M-7528	38-4062-00	14+	90	Incl.
	2/0	M-7529	38-4062-00	14+	90	Incl.
	3/0	M-7530	38-4062-00	14+	115	Incl.
	4/0	M-7531	38-4062-00	14+	115	Incl.

PACKING MATERIAL NOTE

A packing pad is necessary when making thermOweld® connections to rebar. Packing material 38-032900 is copper shim stock. Packing material numbers 38-4061-00, 38-4062-00 and 38-4063-00 are a ceramic fiber material and can be used for one connection only. Be sure to specify packing material catalog number when ordering mold and weld metal.

NOTES:

- For sizes not listed, contact BURNDY®
- Molds listed are for concentric stranded cable; add suffix "S" to mold number for solid conductors
- For heavy duty molds, molds with wear plates or molds for Copperweld® cable, contact BURNDY®
- For expedited service, contact BURNDY®

Required Tools:

Handle Clamps - see chart for correct handle catalog number

Recommended Accessories:

38-0309-00 Flint Ignitor
 38-3922-00 Mold Cleaning Brush
 38-0135-00 Cable Cleaning Brush
 38-0330-00 Cable Clamp

① 38-0309-00 Flint ignitor included

Type CRE-2 Molds

Horizontal Cable Tap to Horizontal Rebar Run

Type CRE-2 Molds are recommended for right angle, horizontal connections for solid or concentric stranded conductors #6 through 4/0 joined to reinforcing bars #3 through #6. The high copper content joint has a higher current carrying capacity than the conductors being joined and is impervious to vibration and moisture.

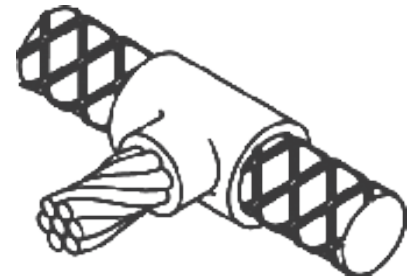

Rebar Size	Cable Size	Mold Number	Packing Material	Price Key	Weld Metal	Handle Clamps
3	#6	M-7588	38-0329-00	4	45	B-106
	#4	M-7589	38-0329-00	4	45	B-106
	#2	M-7590	38-0329-00	4	65	B-106
	#1	M-7591	38-0329-00	4	65	B-106
	1/0	M-7592	38-0329-00	4	90	B-106
	2/0	M-7593	38-0329-00	4	90	B-106
	3/0	M-7594	38-0329-00	4	115	B-106
	4/0	M-7595	38-0329-00	4	115	B-106
4	#6	M-7596	38-0329-00	4	45	B-106
	#4	M-7597	38-0329-00	4	45	B-106
	#2	M-7598	38-0329-00	4	65	B-106
	#1	M-7599	38-0329-00	4	65	B-106
	1/0	M-7600	38-0329-00	4	90	B-106
	2/0	M-7601	38-0329-00	4	90	B-106
	3/0	M-7602	38-0329-00	4	115	B-106
	4/0	M-7603	38-0329-00	4	115	B-106
5	#6	M-7604	38-0329-00	4	90	B-106
	#4	M-7605	38-0329-00	4	90	B-106
	#2	M-7606	38-0329-00	4	90	B-106
	#1	M-7607	38-0329-00	4	90	B-106
	1/0	M-7608	38-0329-00	4	115	B-106
	2/0	M-7609	38-0329-00	4	115	B-106
	3/0	M-7610	38-0329-00	4	150	B-106
	4/0	M-7611	38-0329-00	4	150	B-106
6	#6	M-7612	38-0329-00	4	90	B-106
	#4	M-7613	38-0329-00	4	90	B-106
	#2	M-7614	38-0329-00	4	90	B-106
	#1	M-7615	38-0329-00	4	90	B-106
	1/0	M-7616	38-0329-00	4	115	B-106
	2/0	M-7617	38-0329-00	4	115	B-106
	3/0	M-7618	38-0329-00	4	150	B-106
	4/0	M-7619	38-0329-00	4	150	B-106

PACKING MATERIAL NOTE

A packing pad is necessary when making thermOweld® connections to rebar. Packing material 38-0329-00 is copper shim stock. Packing material numbers 38-4061-00, 38-4062-00 and 38-4063-00 are a ceramic fiber material and can be used for one connection only. Be sure to specify packing material catalog number when ordering mold and weld metal.

NOTES:

- For sizes not listed, contact BURNDY®
- Molds listed are for concentric stranded cable; add suffix "-S" to mold number for solid conductors
- For heavy duty molds, molds with wear plates or molds for Copperweld® cable, contact BURNDY®
- For expedited service, contact BURNDY®

Required Tools:

Handle Clamps - see chart for correct handle catalog number

Recommended Accessories:

38-0309-00 Flint Ignitor
38-3922-00 Mold Cleaning Brush
38-0135-00 Cable Cleaning Brush
38-0330-00 Cable Clamp

Type CRE-3 Molds

Horizontal through Cable to Vertical Rebar

Type CRE-3 Molds are recommended for horizontal conductors to vertical rebar connections for solid or concentric stranded conductors #6 through 4/0 joined to reinforcing bars #3 through #7 & larger. The high copper content joint has a higher current carrying capacity than the conductors being joined and is impervious to vibration and moisture. Contact BURNDY® for information on molds for conductors not listed below.

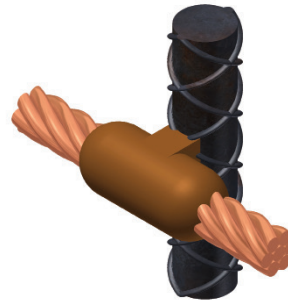

Rebar Size	Cable Size	Mold Number	Packing Material	Price Key	Weld Metal	Handle Clamps
3	#6	M-7620	38-0329-00	24	90	B-106
	#4	M-7621	38-0329-00	24	90	B-106
	#2	M-7622	38-0329-00	24	90	B-106
	#1	M-7623	38-0329-00	24	115	B-106
	1/0	M-7624	38-0329-00	24	115	B-106
	2/0	M-7625	38-0329-00	24	115	B-106
	3/0	M-7626	38-0329-00	24	150	B-106
	4/0	M-7627	38-0329-00	24	150	B-106
4	#6	M-7628	38-0329-00	24	90	B-106
	#4	M-7629	38-0329-00	24	90	B-106
	#2	M-7630	38-0329-00	24	90	B-106
	#1	M-7631	38-0329-00	24	115	B-106
	1/0	M-7632	38-0329-00	24	115	B-106
	2/0	M-7633	38-0329-00	24	115	B-106
	3/0	M-7634	38-0329-00	24	150	B-106
5	#6	M-7636	38-0329-00	24	90	B-106
	#4	M-7637	38-0329-00	24	90	B-106
	#2	M-7638	38-0329-00	24	90	B-106
	#1	M-7639	38-0329-00	24	115	B-106
	1/0	M-7640	38-0329-00	24	115	B-106
	2/0	M-7641	38-0329-00	24	115	B-106
	3/0	M-7642	38-0329-00	24	150	B-106
	4/0	M-7643	38-0329-00	24	150	B-106

NOTES:

- For sizes not listed, contact BURNDY®
- Molds listed are for concentric stranded cable; add suffix "-S" to mold number for solid conductors
- For heavy duty molds, molds with wear plates or molds for Copperweld® cable, contact BURNDY®
- For expedited service, contact BURNDY®

PACKING MATERIAL NOTE

A packing pad is necessary when making thermOweld® connections to rebar. Packing material 38-0329-00 is copper shim stock. Packing material numbers 38-4061-00, 38-4062-00 and 38-4063-00 are a ceramic fiber material and can be used for one connection only. Be sure to specify packing material catalog number when ordering mold and weld metal.

Rebar Size	Cable Size	Mold Number	Packing Material	Price Key	Weld Metal	Handle Clamps	
6	#6	M-7644	38-0329-00	24	90	B-106	
	#4	M-7645	38-0329-00	24	90	B-106	
	#2	M-7646	38-0329-00	24	90	B-106	
	#1	M-7647	38-0329-00	24	115	B-106	
	1/0	M-7648	38-0329-00	24	115	B-106	
	2/0	M-7649	38-0329-00	24	115	B-106	
	3/0	M-7650	38-0329-00	24	150	B-106	
	4/0	M-7651	38-0329-00	24	150	B-106	
	7 & Larger	#6	M-7652	38-4063-00	4	90	B-106-41
		#4	M-7653	38-4063-00	4	90	B-106-41
#2		M-7654	38-4063-00	4	90	B-106-41	
#1		M-7655	38-4063-00	4	115	B-106-41	
1/0		M-7656	38-4063-00	4	115	B-106-41	
2/0		M-7657	38-4063-00	4	115	B-106-41	
3/0		M-7658	38-4063-00	4	150	B-106-41	
4/0		M-7659	38-4063-00	4	150	B-106-41	

Required Tools:

Handle Clamps - see chart for correct handle catalog number

Recommended Accessories:

- 38-0309-00 Flint Ignitor
- 38-3922-00 Mold Cleaning Brush
- 38-0135-00 Cable Cleaning Brush
- 38-0330-00 Cable Clamp

Type CRE-4 Molds

Horizontal through Cable to Horizontal Rebar

Type CRE-4 Molds are recommended for horizontal through conductors to horizontal rebar at right angle connections for solid or concentric stranded conductors #6 through 4/0 joined to reinforcing bars #3 through #6 & larger. The high copper content joint has a higher current carrying capacity than the conductors being joined and is impervious to vibration and moisture. Contact BURNDY® for information on molds for conductors not listed below.

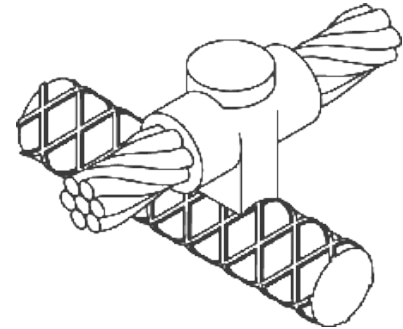

Rebar Size	Cable Size	Mold Number	Packing Material	Price Key	Weld Metal	Handle Clamps
3	#6	M-7708	38-0329-00	4	65	B-106
	#4	M-7709	38-0329-00	4	65	B-106
	#2	M-7710	38-0329-00	4	90	B-106
	#1	M-7711	38-0329-00	4	90	B-106
	1/0	M-7712	38-0329-00	22	115	B-106
	2/0	M-7713	38-0329-00	22	115	B-106
	3/0	M-7714	38-0329-00	22	150	B-106
	4/0	M-7715	38-0329-00	22	150	B-106
4	#6	M-7716	38-0329-00	4	65	B-106
	#4	M-7717	38-0329-00	4	65	B-106
	#2	M-7718	38-0329-00	4	90	B-106
	#1	M-7719	38-0329-00	22	90	B-106
	1/0	M-7720	38-0329-00	22	115	B-106
	2/0	M-7721	38-0329-00	22	115	B-106
	3/0	M-7722	38-0329-00	22	150	B-106
	4/0	M-7723	38-0329-00	22	150	B-106
5	#6	M-7724	38-0329-00	4	65	B-106
	#4	M-7725	38-0329-00	4	65	B-106
	#2	M-7726	38-0329-00	4	90	B-106
	#1	M-7727	38-0329-00	22	90	B-106
	1/0	M-7728	38-0329-00	22	115	B-106
	2/0	M-7729	38-0329-00	22	115	B-106
	3/0	M-7730	38-0329-00	22	150	B-106
	4/0	M-7731	38-0329-00	22	150	B-106
6 & Larger	#6	M-7732	38-4061-00	14 ①	65	Incl.
	#4	M-7733	38-4061-00	14 ①	65	Incl.
	#2	M-7734	38-4061-00	14 ①	90	Incl.
	#1	M-7735	38-4061-00	14 ①	90	Incl.
	1/0	M-7736	38-4062-00	14 ①	115	Incl.
	2/0	M-7737	38-4062-00	14 ①	115	Incl.
	3/0	M-7738	38-4062-00	14 ①	150	Incl.
	4/0	M-7739	38-4062-00	14 ①	150	Incl.

PACKING MATERIAL NOTE

A packing pad is necessary when making thermOweld® connections to rebar. Packing material 38-0329-00 is copper shim stock. Packing material numbers 38-4061-00, 38-4062-00 and 38-4063-00 are a ceramic fiber material and can be used for one connection only. Be sure to specify packing material catalog number when ordering mold and weld metal.

NOTES:

- For sizes not listed, contact BURNDY®
- Molds listed are for concentric stranded cable; add suffix "-S" to mold number for solid conductors
- For heavy duty molds, molds with wear plates or molds for Copperweld® cable, contact BURNDY®
- For expedited service, contact BURNDY®

Required Tools:

Handle Clamps - see chart for correct handle catalog number

Recommended Accessories:

38-0309-00 Flint Ignitor
38-3922-00 Mold Cleaning Brush
38-0135-00 Cable Cleaning Brush
38-0330-00 Cable Clamp

① 38-0309-00 Flint ignitor included

Type CRE-6 Molds Horizontal Cable Tap to Vertical Rebar

Type CRE-6 Molds are recommended for horizontal conductors terminating at right angles to vertical rebar connections for solid or concentric stranded conductors #6 through 4/0 joined to reinforcing bars #3 through #7 and larger. The high copper content joint has a higher current carrying capacity than the conductors being joined and is impervious to vibration and moisture.

Contact BURNDY® for information on molds for conductors not listed below.



PACKING MATERIAL NOTE

A packing pad is necessary when making thermOweld® connections to rebar. Packing material 38-0329-00 is copper shim stock. Packing material numbers 38-4061-00, 38-4062-00 and 38-4063-00 are a ceramic fiber material and can be used for one connection only. Be sure to specify packing material catalog number when ordering mold and weld metal.

Rebar Size	Cable Size	Mold Number	Packing Material	Price Key	Weld Metal	Handle Clamps
3	#6	M-7884	38-0329-00	4	45	B-106
	#4	M-7885	38-0329-00	4	45	B-106
	#2	M-7886	38-0329-00	4	65	B-106
	#1	M-7887	38-0329-00	4	90	B-106
	1/0	M-7888	38-0329-00	4	115	B-106
	2/0	M-7889	38-0329-00	4	115	B-106
	3/0	M-7890	38-0329-00	4	150	B-106
	4/0	M-7891	38-0329-00	4	150	B-106
4	#6	M-7892	38-0329-00	4	45	B-106
	#4	M-7893	38-0329-00	4	65	B-106
	#2	M-7894	38-0329-00	4	65	B-106
	#1	M-7895	38-0329-00	4	90	B-106
	1/0	M-7896	38-0329-00	4	115	B-106
	2/0	M-7897	38-0329-00	4	115	B-106
	3/0	M-7898	38-0329-00	4	150	B-106
	4/0	M-7899	38-0329-00	4	150	B-106
5	#6	M-7900	38-0329-00	4	45	B-106
	#4	M-7901	38-0329-00	4	65	B-106
	#2	M-7902	38-0329-00	4	65	B-106
	#1	M-7903	38-0329-00	4	90	B-106
	1/0	M-7904	38-0329-00	4	115	B-106
	2/0	M-7905	38-0329-00	4	115	B-106
	3/0	M-7906	38-0329-00	4	150	B-106
	4/0	M-7907	38-0329-00	4	150	B-106

Rebar Size	Cable Size	Mold Number	Packing Material	Price Key	Weld Metal	Handle Clamps
6	#6	M-7908	38-0329-00	4	45	B-106
	#4	M-7909	38-0329-00	4	65	B-106
	#2	M-7910	38-0329-00	4	65	B-106
	#1	M-7911	38-0329-00	4	90	B-106
	1/0	M-7912	38-0329-00	4	115	B-106
	2/0	M-7913	38-0329-00	4	115	B-106
	3/0	M-7914	38-0329-00	4	150	B-106
	4/0	M-7915	38-0329-00	4	150	B-106
7 & Larger	#6	M-7916	38-4063-00	4	45	B-106-32 ①
	#4	M-7917	38-4063-00	4	65	B-106-32 ①
	#2	M-7918	38-4063-00	4	65	B-106-32 ①
	#1	M-7919	38-4063-00	4	90	B-106-32 ①
	1/0	M-7920	38-4063-00	4	115	B-106-32 ①
	2/0	M-7921	38-4063-00	4	115	B-106-32 ①
	3/0	M-7922	38-4063-00	4	150	B-106-32 ①
	4/0	M-7923	38-4063-00	4	150	B-106-32 ①

NOTES:

- For sizes not listed, contact BURNDY®
- Molds listed are for concentric stranded cable; add suffix "-S" to mold number for solid conductors
- For heavy duty molds, molds with wear plates or molds for Copperweld® cable, contact BURNDY®
- For expedited service, contact BURNDY®

- ① The **B106-32** comes complete with a **B-106** handle clamp and **40-0106-76** vertical chain clamp. Although good for use on all sizes of rebar, vertical chain clamps are strongly recommended on large size rebar as they hold the mold to the rebar securely. If you already have a B-106 handle clamp, you can purchase the vertical chain clamps separately.

Required Tools:

Handle Clamps - see chart for correct handle catalog number

Recommended Accessories:

- 38-0309-00** Flint Ignitor
- 38-3922-00** Mold Cleaning Brush
- 38-0135-00** Cable Cleaning Brush
- 38-0330-00** Cable Clamp

thermOweld® Contact - GF

Contact - GF is an economical solution for areas with very difficult grounding issues. Contact - GF is highly conductive in a wet or dry application and does not require moisture to lower the resistance of your grounding system. Contact - GF contains a corrosion inhibitor which forms a film on copper, creating a barrier against corrosion. Contact - GF can be poured in dry or pumped in slurry form. No tamping required. It is very contractor friendly. No special tools required.

Catalog Number	Description
38-6501-25	Contact - GF 25 lb
38-6501-50	Contact - GF 50 lb

thermOweld® Contact - GF Advantages:

- Easy to install
- Electrically conductive
- Environmentally friendly
- Will not leach into the ground
- Positive low resistance, electrical connection to earth
- Does not contain any hazardous chemicals
- Compatible with all copper grounding systems
- Contains a corrosion inhibitor to protect copper
- Will not expand or shrink
- Not affected by freezing
- Excellent shelf life
- Typical resistivity <10 Ohm-cm

Material Required per Linear Foot of Trench												
Width of Trench (inches)												
		4	6	8	10	12	14	16	18	20	22	24
Thickness of thermOweld® Contact - GF (Inches)	2	4.10	6.20	8.10	10.10	12.10	14.10	16.20	18.20	20.20	22.20	24.20
	3	6.20	9.30	12.10	15.20	18.20	21.20	24.20	27.30	30.30	33.30	36.40
	4	8.20	12.30	16.20	20.20	24.20	28.30	32.30	36.40	40.40	44.50	48.50
	5	10.30	15.40	20.20	25.30	30.30	35.40	40.40	45.50	50.60	55.60	60.60
	6	12.30	18.50	24.20	30.30	36.40	42.40	48.50	54.60	60.60	66.70	72.70
	7	14.40	21.60	28.30	35.40	42.40	49.50	56.60	63.70	70.70	77.80	84.90
	8	16.40	24.70	32.30	40.40	48.50	56.00	64.70	72.70	80.80	88.90	97.00
	9	18.50	27.80	36.40	45.50	54.60	63.70	72.70	81.80	90.90	100.00	109.10
	10	20.60	30.80	40.40	50.50	60.60	70.70	80.80	90.90	101.00	111.10	121.20

To calculate the pounds of material required to fill a trench:

- Determine desired thickness
- Move to the right on the chart above until you are under the known width of the trench - this number will be the weight of the material in lbs/linear ft
- Take this number and multiply by the length of the trench in feet; your answer will be the amount of Contact - GF material required to fill the trench to the desired level in pounds

Example:

Thickness = 6 inches
 Width of trench = 18 inches
 54.6 lbs per linear ft (see table above)
 Answer = 54.6 lbs per linear ft x 25 ft trench = 1,365 lbs of thermOweld® Contact - GF
 = Quantity of 28 50-lb bags of Contact - GF

thermOweld® Contact - GF

Application Information

Vertical Installation

Drill or bore a hole the desired diameter and depth. Suspend ground electrode in center of hole to be filled. Pour Contact - GF until desired level is obtained. No tamping is required.

Horizontal or Grid Construction ①

Pour into horizontal trench until level of ground wire is reached. Place ground wire. Pour additional Contact - GF until wire is covered to desired height. Cover with fill. No tamping required.

For grid construction, pour thermOweld® Contact - GF and spread over ground grid until desired thickness is achieved. Cover with fill.

① Entire grounding system should be surrounded by thermOweld® Contact - GF. Conductors should be insulated as they exit Contact - GF column.

Dry Volume of thermOweld® Contact - GF vs. Hole Size		Ground Resistance Comparison of Bare Rod vs.	
Hole Size	Lbs. of Contact - GF Per Ft.	Hole Size with 5/8" x 10' Rod in Center of 15' Hole	Percent Resistance Compared to Rod Only (100%)
4"	6.5	4"	52%
6"	14.5	6"	47%
8"	25.8	8"	44%
10"	40.4	10"	42%
12"	58.1	12"	40%

Steady State Leakage Resistance ② Using 4/0 Copper Wire vs. thermOweld® Contact - GF					
Length	0.457" Diameter Wire Only	Percentage of Resistance with 0.457" Wire Plus Contact - GF in Various Diameters Compared to Wire Only (100%)			
		2"	3"	4"	6"
25'	100%	83%	78%	74%	69%
50'	100%	85%	81%	77%	73%
75'	100%	86%	82%	79%	75%
100'	100%	87%	83%	80%	77%
150'	100%	88%	84%	82%	78%
200'	100%	88%	85%	83%	79%
250'	100%	89%	85%	83%	80%
300'	100%	89%	86%	84%	80%

② The use of Contact - GF around the grounding system will also reduce surge impedance by increasing the effective contact area of the electrode to soil.

Horizontal Construction

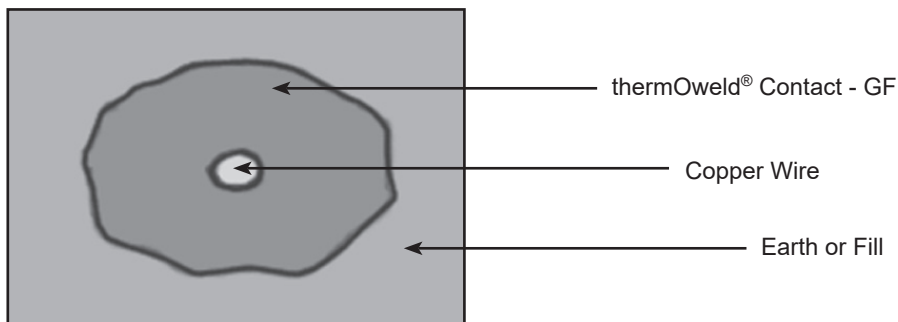

Grid Construction

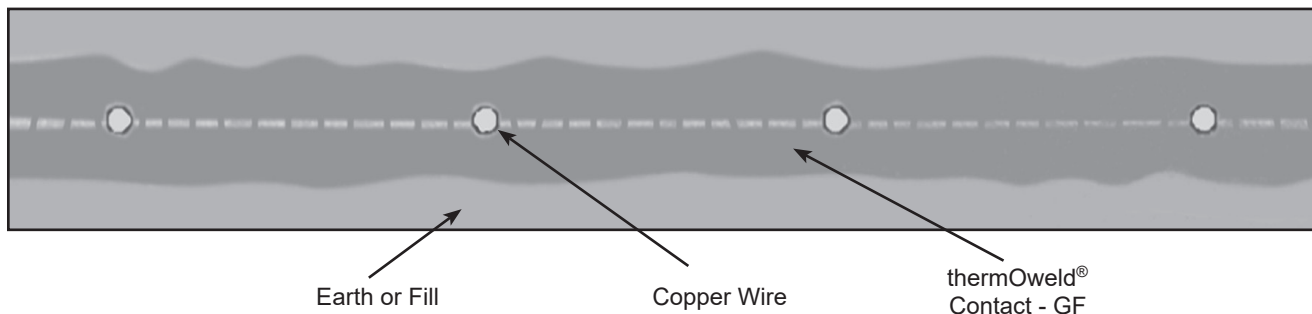

Handle Clamps

thermOweld® Handle Clamps make possible the use of many different sizes and types of molds with only two different clamps. The two handle clamps are catalog numbers **B-106** & **B-107**. These will fit 95% of all standard thermOweld® molds.

1. Use B-106 clamps for all molds having a price key 4, 7, 17, 22 or 24. These molds are a nominal 3 1/8" x 3 1/8" square.
2. Use B-107 clamps for all molds having a price key 5, 6, 8 or 23. These molds are a nominal 4" x 4" square.
3. All molds having a price key 2, 3, 9, 10, 11, 12, 14, 15 or 16 have an attached frame; separate handles are not required.

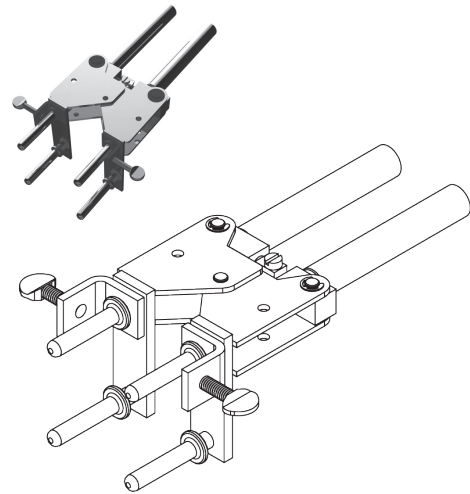

Handle Attachment

This Handle Attachment is used to hold Price Key 14 molds in position. It easily attaches to the B-106 Handle Clamp. This Handle Attachment can be used with weld types CRE-1 and CRE-4.

Catalog Number: **40-0106-75**

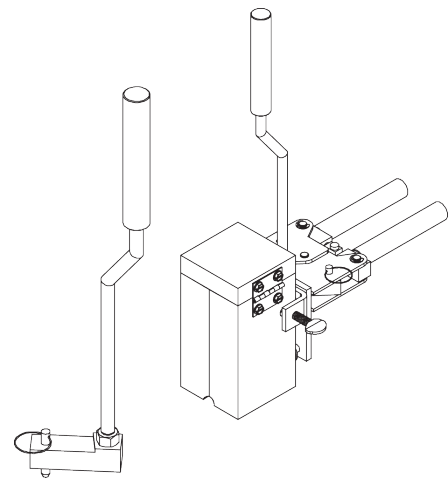

Mold Support Clamp

Mold Support Clamp is used to hold a mold in position on a vertical steel column or angle. It is easily attached to the Handle Clamps. The Mold Support Clamp can be used with weld types CS-3, CS-18, CS-23 and CS-27.

Catalog Number: **40-3657-00**

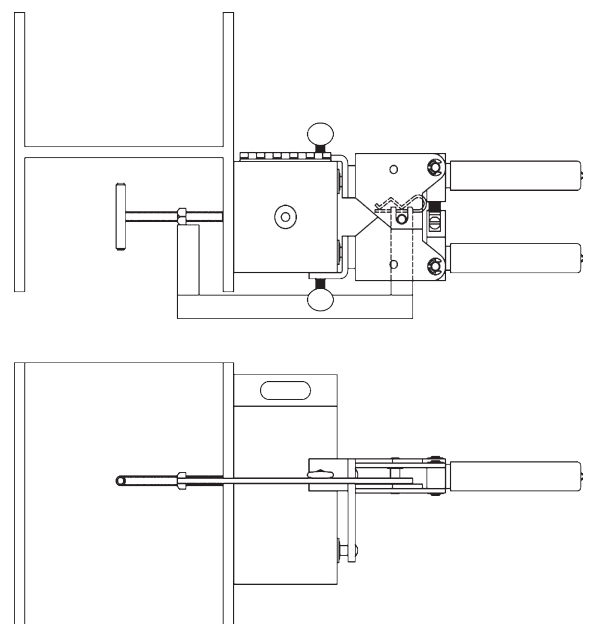
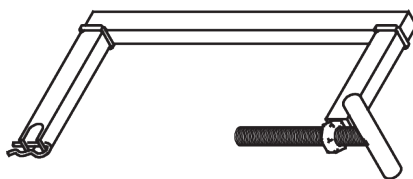

Vertical Magnetic Clamps

Magnetic Clamps are used to hold a mold in position on a vertical steel surface. The magnetic clamp can be purchased complete with B-106 Handle Clamps or if you already have a set of handle clamps, you can order just the magnetic mounting assembly. The mounting assembly can easily be mounted on the prongs of your existing B-106 handle clamps. A minimum of 10" is required.

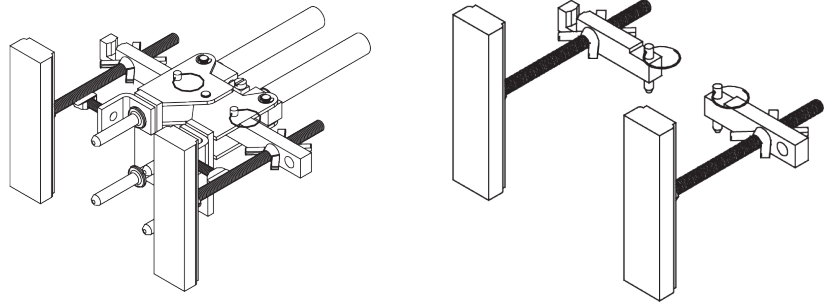

Magnetic Clamps with B-106 Handle		
Catalog Number	Fits Molds w/ Price Key	For Use with Weld Types
40-4431-00	4 & 17	CS-3, 4, 7 & 23

Magnetic Clamp Only		
Catalog Number	Fits Handle Clamps	For Use with Weld Types
40-4431-01	B-106 & B-107	CS-3, 4, 7 & 23

Horizontal and Vertical Chain Clamps

Chain Clamps are used to hold a mold in position on horizontal or vertical pipe up to 4" in diameter. For larger pipe a 20" chain extension is available to allow the chain clamps to be used on pipe up to 10" in diameter. The chain clamp can be purchased complete with B-106 or B-107 Handle Clamps or if you already have a set of handle clamps, you can order just the chain clamp and mounting assembly. The mounting assembly can easily be attached to your existing handle clamps.

20" Chain Extension Catalog number: 40-0106-27

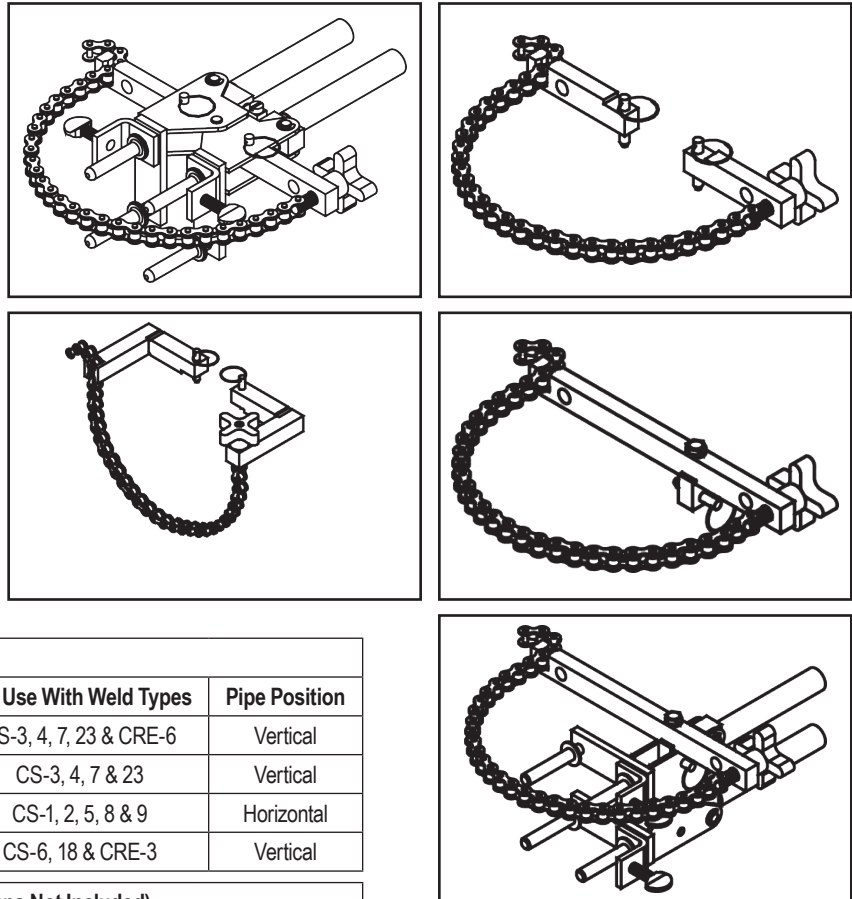

Chain Clamps			
Catalog Number	Fits Molds W/Price Key	For Use With Weld Types	Pipe Position
40-0106-32	4, 17, 22 & 24	CS-3, 4, 7, 23 & CRE-6	Vertical
40-0107-32	5, 6 & 23	CS-3, 4, 7 & 23	Vertical
40-0106-37	4, 17, 22 & 24	CS-1, 2, 5, 8 & 9	Horizontal
40-0106-41	4, 17	CS-6, 18 & CRE-3	Vertical

Chain Clamp Only (Handle Clamps Not Included)			
Catalog Number	Fits Handle Clamp	For Use With Weld Types	Pipe Position
40-0106-76	B-106 & B-107	CS-3, 4, 7, 23 & CRE-6	Vertical
40-0106-78	B-106 & B-107	CS-1, 2, 5, 8 & 9	Horizontal
40-0106-77	B-106 & B-107	CS-6, 18 & CRE-3	Vertical

Cable Clamp

The thermOweld® Cable Clamp is recommended for holding a wide range of cables properly in place in molds when welding cables that are under tension. This prevents the cables from pulling out of the mold when the weld is made.

Cable Clamp: **38-0330-00**

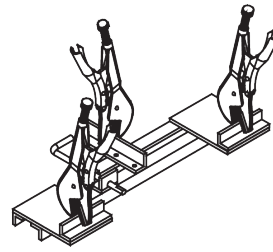

Cable Cleaning and Card Cloth Brush

The Cable Cleaning Brush is recommended for cleaning heavily oxidized cables. The V-shape brushes permit their use over a wide range of cable sizes. Brush assembly consists of a handle with two stiff wire bristle brushes that are rotatable, for longer life and are replaceable.

The Card Cloth Brush is used for cleaning large conductors and bus bar. It has short stiff bristles. These brushes are for cleaning cable only, not molds.

The Mold Cleaning Brush **38-3922-00** is used to clean the graphite mold without scratching the mold.

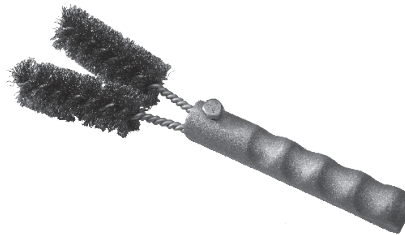

Description	Catalog Number
Cable Cleaning Brush	38-0305-00
Replacement Brush	38-0135-01
Card Cloth Brush	38-0306-00
Mold Cleaning Brush	38-3922-00



Mold Cleaners

Mold Cleaners are used to clean the slag from molds that are not split through the crucible.

40-0319-01 for cartridge sizes #15 through #65

40-0319-03 for cartridge sizes #90 through #500



Packing Material

Packing material is used to prevent the molten weld metal from leaking out of the mold. When the cable opening becomes worn from heavy use, the packing material may be used to prolong mold use. It is also used around 7 strand cable to prevent leaking. Packing material comes in a 1 lb. or 5 lb. package.

Description	Catalog Number
1 lb. package	38-4129-00
5 lb. package	38-4129-05

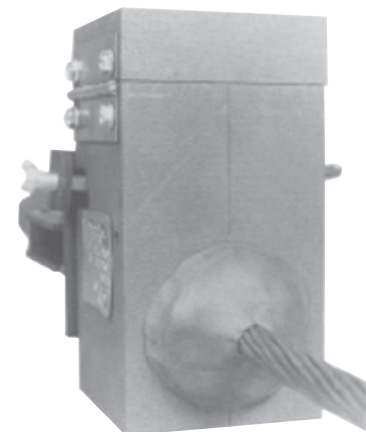

Tool Kit



- 38-0302-00** Tool Kit with Tools Shown except Rasp
- 38-0302-02** Tool Kit with Tools Shown and Rasp
- 38-0303-00** Tool Box only



thermOweld® Tools

The **38-0309-00** Flint Ignitor is used to ignite the starting powder. Each mold that is sold with a frame has a Flint Ignitor included.

For added safety a Flint Ignitor extension is available, catalog number **38-0904-00**, that attaches to the B38-0309-00 Flint Ignitor. This allows installers to stay approximately 36" away from the mold.

To order replacement flints, specify part number **38-0309-01**.

- 38-0309-00** Flint Ignitor
- 38-0304-00** 8" File
- 38-0307-00** Crimping Tool
- 38-3922-00** Mold Cleaning Brush
- 38-0308-00** 6" Screwdriver
- 38-0305-00** Wire Brush
- 38-0101-00** Rasp
- 38-0306-00** Card Cloth Brush

38-0101-00 Rasp

This tempered steel, curved rasp is recommended for removing rust and mill scale from steel and cast iron surfaces. The blade is replaceable. To order replacement rasp blade, specify catalog number **38-0101-01**.

Not recommended for use on galvanized surfaces.

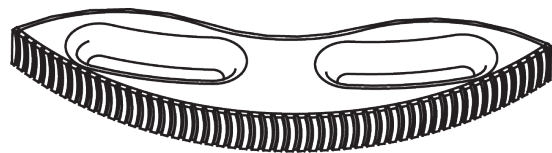

38-0309-00 Flint Ignitor

The **38-0309-00** Flint Ignitor is used to ignite the starting powder. Each mold that is sold with a frame has a Flint Ignitor included. For added safety a Flint Ignitor extension is available, catalog number B38-0904-00, that attaches to the **38-0309-00** Flint Ignitor. This allows installers to stay approximately 36" away from the mold.

To order replacement flints, specify part number **38-0309-01**



Ground Rod Driving Sleeves

Ground Rod Driving Sleeves are placed over the top of a ground rod while driving it into the ground. This prevents the top from mushrooming or flaring out. Ground rod driving sleeves are available in sizes to fit all standard unthreaded ground rods.



Catalog Number	For Use On
38-3662-01	1/2" Copper Clad or Steel Ground Rod
38-3662-02	5/8" Copper Clad Ground Rod
38-3662-05	5/8" Steel Ground Rod
38-3662-03	3/4" Copper Clad Ground Rod
38-3662-06	3/4" Steel Ground Rod
38-3662-04	1" Copper Clad Ground Rod

Shim Stock and Adapter Sleeves

thermOweld® molds designed for larger cable sizes can be used on smaller diameter cables if copper adapter sleeves or shim stock are utilized. The copper shim stock, .0108" x 1-1/2" x 3", is normally wrapped around cable until the diameter is about equal to the cable opening. A tight fit is not necessary as the shim stock will unwrap slightly and prevent leakage of weld metal.

To order shim stock use part number **38-0329-00**. Shim stock comes 100 pieces per box.

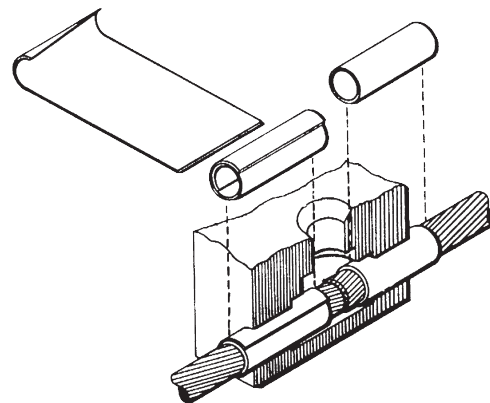

For Use on Cable Size		Part Number	Use in Mold Size	Sleeve Dimensions		
Stranded	Solid			O.D. Size	I.D.	Length
#12, #14	#10, #12, #14	38-0200-00	#6 Str. & Sol.	0.15	0.11	1.00
#9, #10	#8, #9, #10	38-0208-00	#4 Sol.	0.20	0.14	1.00
#7, #8, #10	#6, #8	38-0201-00	#4	0.22	0.17	1.00
#6	#5	38-0202-00	#2	0.29	0.19	1.00
#4, #5	#3, #4	38-0207-00	#2	0.30	0.24	1.00
#4	#2	38-0204-00	#1	0.34	0.24	1.00
#2	#1	38-0203-00	1/0	0.37	0.30	1.00
#1	1/0	38-0209-00	2/0	0.42	0.35	1.00
1/0, #1	2/0	38-0205-00	3/0 & 4/0 Sol.	0.46	0.38	1.00
2/0, 1/0	3/0	38-0240-00	4/0	0.52	0.43	1.50
4/0	—	38-0211-00	300 kcmil	0.62	0.54	1.25
250 kcmil	—	38-0212-00	350 kcmil	0.67	0.59	1.25
350, 400 kcmil	—	38-0213-00	500 kcmil	0.81	0.76	1.50
250, 300, 350 kcmil	—	38-0214-00	500 kcmil	0.81	0.70	1.50
750, 800 kcmil	—	38-0215-00	1000 kcmil	1.15	1.05	1.50

Table of Contents

Wiley Solutions - Not Just for Solar Anymore!
 Solutions for Standard or Challenging Wire Management, Bonding, or
 Grounding Applications E-151

Wiley Cable Clips
 Flange Clips..... E-152
 90° Flange Clips..... E-153
 180° Flange Clips..... E-153
 Rail Clips E-153

Wiley Bundle Straps E-154

Wiley Edge Clip with Cable Tie E-155

Wiley Coated Wire Management
 Coated P-Clips E-156

Wiley Cable Hanger Family E-157

Grounding Lugs E-158

WEEB® Washers (Washer Electrical Equipment Bond)..... E-159

Telecom WEEB® Washer Two-Hole E-166

Telecom WEEB® Washer Single Hole E-167

Bonding Jumper..... E-168
 Tin-plated Braided Copper E-168
 WEEB® Rope Lay Jumpers E-171
 Wiley Rope Lay Jumper E-172

Mid-Clamps E-173

Most frequently ordered catalog numbers are highlighted in BLUE

Wiley Solutions Not just for Solar Anymore!

Whether installing miles of wire or acres of solar modules, the components no bigger than a few inches can give the project long-term success and provide peace of mind. As PV technology has evolved, BURNDY continues to provide solutions that meet the requirements of the most challenging applications.

The Wiley product offering encompasses varied products to suit the application at hand.

Bonding Jumpers of corrosion resistant, tin-plated copper are available with or without the Wiley WEEB® washer. UL467 and UL2703 Listed.

Clamping Solutions offer reliability throughout the lifetime of the PV system. Mid-Clamp and End-Clamp designs for all types of solar module bonding. UL2703 Listed.

Grounding Lugs available with or without the WEEB® washer require no surface preparation of the mounting surface. UL467 and UL2703 Listed.

WEEB® Washers (Washer Electrical Equipment Bond) eliminate the need for older, more expensive grounding methods, and surface preparation like masking or scratch brushing. The WEEB® teeth pierce through most non-conductive coatings

(e.g. anodization and powder coating) and embed into the underlying metal thus creating a bonding connection between the surface and the coated metal component that it is installed on or between (e.g. equipment racks, cabinets, enclosures, cable tray, lugs, etc.). Corrosion-resistant 304 stainless steel construction available in a myriad of styles all providing excellent conductivity without oxidation risk. UL467 and UL2703 Listed.

Wiley Cable Clips simplify wire management and provide a neat and orderly aesthetic to solar PV arrays and other installations. For use with a broad range of cable combinations and sizes. No tools required for installation and compatible on modules and a variety of rails. UL1565 Listed.

Wiley Bundle Straps manage bundles of wire. UV rated vinyl jacketing is designed to help protect the cable insulation from damage. Stainless Steel ferrule and wire safeguards system longevity. UL62275 Listed.

P-Clips manage bundles of wire and are reusable. Coated steel protects cables from vibration and insulation damage. UL1565 and UL62275 Listed.

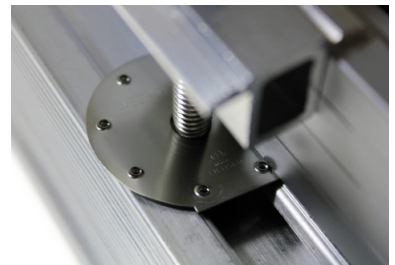

Wiley Cable Clips High-quality wire management solutions

Engineered for high-quality wire management solutions, Wiley Cable Clips simplify wire management and create a cleaner aesthetic to solar PV arrays. The clips are made of corrosion resistant stainless steel, which makes for a durable, long lasting and reliable solution in all environments and are designed with coined and rolled edges to prevent damage to cable insulation. The designs are easy to install and remove with a flat head screwdriver. The clips can be used in a wide variety of mounting configurations (including 90 and 180 degrees) for module and rail applications. Custom designs are available upon request.

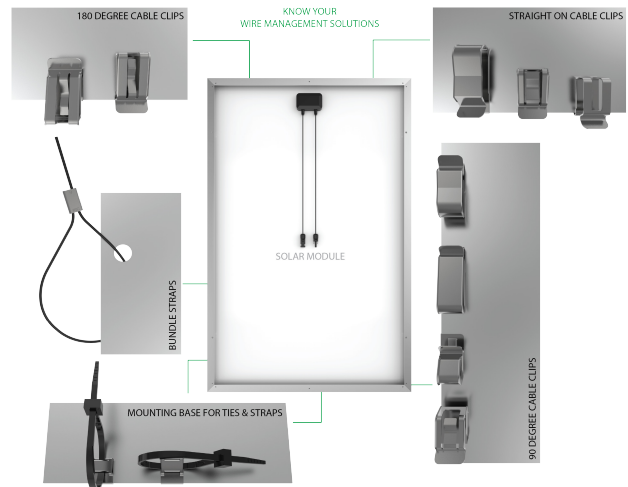

Features and Benefits:

- UL 1565 Listed
- Accommodates a broad range of cable combinations and sizes (e.g., USE-2, PV, AC module, and micro inverter cables)
- Environmentally tested - UL 2703 and ASTM B117
- No tools required for installation
- Coined and rolled edges to prevent damage to cable insulation
- Reliability for use throughout the lifetime of the PV system















Flange Clips

304 Stainless Steel cable clips that install on the module frame or other equipment flange.

Line Image	Catalog Number	Qty of Wires Held	Wire Diameter inch [mm]	Flange Thickness Accommodated
	ACC	1 to 2 USE-2 wires or 1 PV wire	Max. 0.216 [5.50]	1.3 - 2.5mm
	ACC-PV	1 to 2 PV wires	Max. 0.275 [7.00]	1.3 - 2.5mm
	ACC-FPV	1 to 2 PV wires	Max. 0.314 [8.00]	1.0 - 3mm

Wiley Cable Clips (Continued)

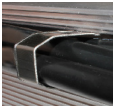
90 Degree Flange Clips				
<i>304 Stainless Steel cable clips that install parallel or perpendicular on the module frame or other equipment flange.</i>				
Line Image	Catalog Number	Qty of Wires Held	Wire Diameter inch [mm]	Flange Thickness Accommodated
	ACC-F90-1	1 to 2 USE-2 wires or 1 to 2 PV wire	Max. 0.29 [7.50]	1.3 - 2.5mm
	ACC-FPV90	1 to 2 PV wires	Max. 0.314 [8.00]	1.0 - 3.0mm
	ACC-F2-90	1 to 2 Micro Inverter Trunk or AC cables	1 wire: Max. 0.55 [14.00] 2 wires Max. 0.43 [11.00]	1.3 - 2.5mm
	ACC-F4-90-1	1 to 4 PV wires	Max. 0.29 [7.50]	1.3 - 2.5mm
	ACC-F490	1 to 4 PV wires	Max. 0.314 [8.00]	1.0 - 3.0mm
	ACC-F4F	1 to 4 PV wires	Max. 0.314 [8.00]	1.0 - 3.0mm
	ACC-F1-270	2 PV wire or 1 Micro Inverter Trunk	Max. 0.55 [14.00]	1.0 - 3.0mm
180 Degree Flange Clips				
<i>304 Stainless Steel cable clips that install on the flange at 180 degrees.</i>				
Line Image	Catalog Number	Qty of Wires Held	Wire Diameter inch [mm]	Flange Thickness Accommodated
	ACC-FPV180	1 to 2 PV wires	Max. 0.314 [8.00]	1.0 - 3.0mm
	ACC-F1-270	1 to 2 PV wires or 1 Micro Inverter Trunk	Max. 0.55 [14.00]	1.0 - 3.0mm
	ACC-FF180	1 to 2 PV wires	Max. 0.314 [8.00]	1.0 - 3.0mm
Rail Clips				
<i>304 Stainless Steel cable clips that install on the rail, channel, or slot.</i>				
Line Image	Catalog Number	Qty of Wires Held	Wire Diameter inch [mm]	Rail Type
	ACC-R2	1 to 2 Micro Inverter Trunk or AC cables	1 wire: Max. 0.55 [14.00] 2 wires Max. 0.43 [11.00]	Unirac, Ironrige or Similar Style
	ACC-R4	1 to 4 PV wires	Max. 0.29 [7.50]	Unirac, Ironrige or Similar Style
	ACC-RBC15	2 Micro Inverter Trunk or up to 4 PV wires	Max. 0.55 [14.00]	Rail Channel or Slot Width: 6.35mm to 13.5mm

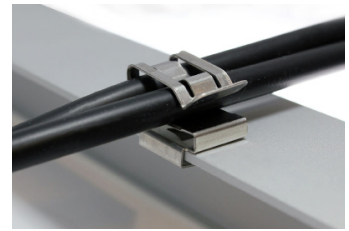

ACC-F90-1 shown in both orientations



ACC-F1-270



ACC-FPV180

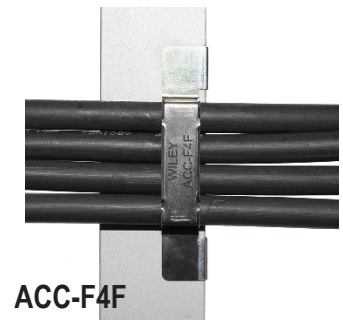

ACC-F4F

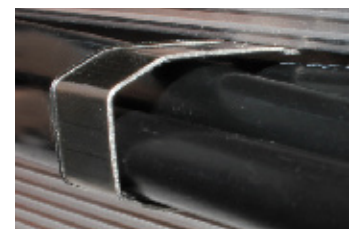

ACC-RBC15 shown

Wiley Bundle Straps

High-quality wire management solutions

The Wiley Bundle Strap is made of corrosion resistant 304 stainless steel, which makes it a durable, long lasting and reliable solution for all environments. The vinyl jacket covering the stainless steel wire is designed to protect cable insulation from damage. The Wiley Bundle Strap is easy to install and can be crimped in the field with electrician linesman pliers or standard wire cutters. The crimp sleeve's retention feature allows for a quick, effortless, secure installation. Custom lengths available upon request.

Features and Benefits:

- UL 62275 Listed
- High quality, long-lasting, labor saving, wire management solution
- UV rated vinyl jacketed stainless steel wire with 304 stainless steel crimp
- Vinyl jacket designed to protect cable insulation from damage
- 304 stainless steel crimp sleeve allows for quick and easy installation
- Can be crimped in the field with electrician linesman pliers or standard wire cutters
- Retention feature allows for a quick, effortless, secure installation
- Lasts for the lifetime of the PV system
- RoHS compliant
- Custom lengths available upon request

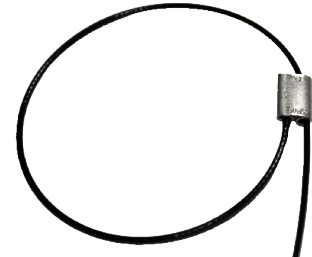

ACC-FBC shown with WBS8V

Installing the ACC-FBC with WBS or UNIRAP™ cable tie

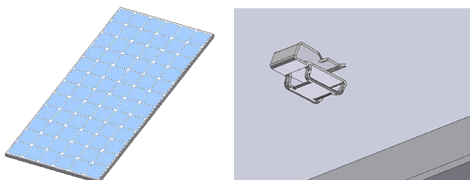

The ACC-FBC mounting base slides onto the module flange

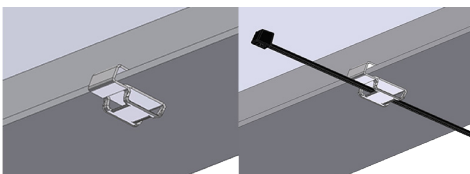

Route a WBS or UNIRAP™ through the ACC-FBC mounting base

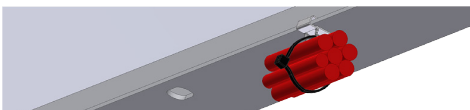

Secure desired cables by tightening the WBS or UNIRAP™

Wiley Bundle Straps

304 Stainless Steel wire covered with vinyl jacket helps protect cable insulation from damage.

Catalog Number	Length inch [mm]	Diameter inch [mm]	Max. Tensile Strength	Max. Bundle Diameter inch [mm]	Material
WBS8V	8.00 [203.20]	0.06 [1.50]	100 lbs.	2.30 [58.40]	Vinyl Insulated 304 Stainless Steel Wire
WBS10V	10.00 [254.00]	0.06 [1.50]	100 lbs.	2.92 [74.00]	
WBS12V	12.00 [304.80]	0.06 [1.50]	100 lbs.	3.88 [98.50]	
WBS14V	14.00 [356.00]	0.06 [1.50]	100 lbs.	4.20 [106.70]	
WBS20V	20.00 [508.00]	0.06 [1.50]	100 lbs.	6.36 [161.50]	
WBS24V	24.00 [609.60]	0.06 [1.50]	100 lbs.	7.00 [178.00]	
WBS30V	30.00 [762.00]	0.06 [1.50]	100 lbs.	8.75 [222.00]	
WBS36V	36.00 [914.40]	0.06 [1.50]	100 lbs.	11.00 [279.40]	

Mounting Platform for WBS Bundle Straps or UNIRAP™ Cable Ties

304 Stainless Steel cable clip used for affixing cable ties to a module flange or similar flange.

Catalog Number	Length inch [mm]	Width inch [mm]	Height inch [mm]	Max. Cable Tie Width inch [mm]	Frame Thickness
ACC-FBC	0.55 [14.00]	0.48 [12.20]	0.27 [7.00]	0.31 [8.00]	1.3mm to 2.5mm

Wiley Edge Clip with Cable Tie (ACC-ECT)
High-quality wire management solutions

The WILEY ACC-ECT is the perfect solution to route cable bundles without the need for mounting holes or additional hardware. The ACC-ECT is a nylon-encased plated steel clip that installs onto the module frame flange and allows a cable tie to be routed in both landscape (on the horizontal/perpendicular portion of the module frame) and portrait (on the vertical/parallel portion of the module frame) orientations. The ACC-ECT is available in UV resistant, high impact heat stabilized nylon 6/6 and nylon 12 material; both the 6/6 and 12 have a tensile strength of 50 lb. Nylon 12 makes the ACC-ECT especially suitable in high moisture, corrosive environments or where low temperatures are a factor.

Features and Benefits:

- Route cable bundles without the need for mounting holes or additional hardware
- Installs in a vertical/parallel (90°) or horizontal/perpendicular (180°) orientation
- Steel lances securely anchor clips to module frames or purlins
- Offered in various nylon types with 50 lb tensile strength:
 - UV resistant, high impact heat stabilized Nylon 6/6
 - UV resistant Nylon 12 which provides excellent UV, chemical and moisture resistance

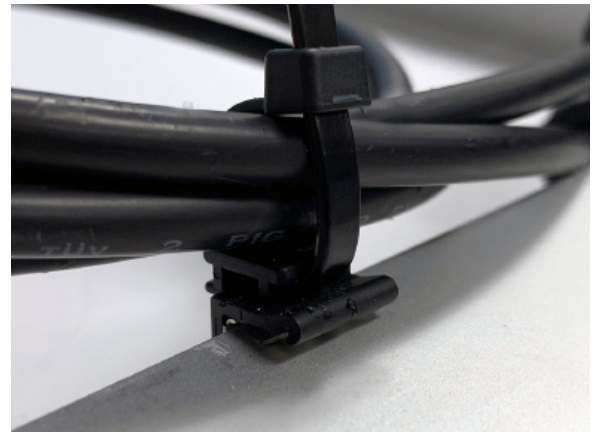

Style A - Vertical/Parallel Installation



Style B - Horizontal/Perpendicular Installation

Style A - Vertical/Parallel Installation

Style B - Horizontal/Perpendicular Installation

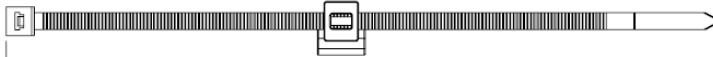

Part Key		
Family	ACC	Acme Cable Clip
Type	ECT	Edge Clip Tie
Style	A	Vertical/Parallel (90°) Installation
	B	Horizontal/Perpendicular (180°) Installation

Catalog Number	Style	Nylon Type	Cable Tie Length	Max. Bundle Dia.
ACC-ECTA68	A	6/6	8" / 200mm	1.95" / 49.5mm
ACC-ECTA611			11" / 280mm	2.95" / 74.8mm
ACC-ECTA614			14" / 360mm	3.94" / 100mm
ACC-ECTA128		12	8" / 200mm	1.95" / 49.5mm
ACC-ECTA1211			11" / 280mm	2.95" / 74.8mm
ACC-ECTA1214			14" / 360mm	3.94" / 100mm
ACC-ECTB68	B	6/6	8" / 200mm	1.95" / 49.5mm
ACC-ECTB611			11" / 280mm	2.95" / 74.8mm
ACC-ECTB614			14" / 360mm	3.94" / 100mm
ACC-ECTB128		12	8" / 200mm	1.95" / 49.5mm
ACC-ECTB1211			11" / 280mm	2.95" / 74.8mm
ACC-ECTB1214			14" / 360mm	3.94" / 100mm

Edge Clip Compartment

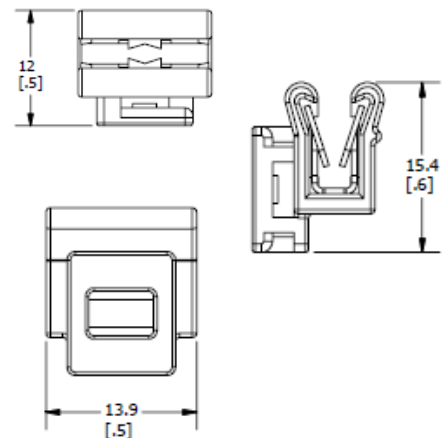

Coated P-Clips

Wiley coated P-Clips are a durable, long lasting and reliable solution for bundling and protecting wires and cables. The vinyl coating acts as a shield against vibration and cable insulation damage. The various bundle sizes easily install into a mounting hole with 1/4" hardware



Wiley Coated P-Clips				
<i>Vinyl coated steel p-clips protect cables from vibration and insulation damage.</i>				
Catalog Number	Width inch [mm]	Max. Bundle Diameter inch [mm]	Material	UL
WIPC14-14	0.24 [6.0]	0.25 [6.4]	PVC coated zinc plated steel	UL 1565 Listed
WIPC14-12	0.24 [6.0]	0.50 [13.0]		
WIPC14-34	0.24 [6.0]	0.75 [19.0]		
WIPC14-1	0.24 [6.0]	1.00 [25.4]		
WIPC14-112	0.24 [6.0]	1.50 [38.0]		



Ratcheting P-Clamps

Wiley ratcheting SUNGRIP™ Ratcheting P-Clamps provide the perfect fit for harnessing varying wire bundle and hose sizes ranging from .75" to 1.5". It is composed of UV resistant polyamide plastic and therefore affords long term durability in outdoor environments. The range-taking ratcheting device is also releasable allowing for repositioning and maintenance without the need to remove the hardware. Models include several mounting hardware sizes as well as a hook option for use at the PV module level.

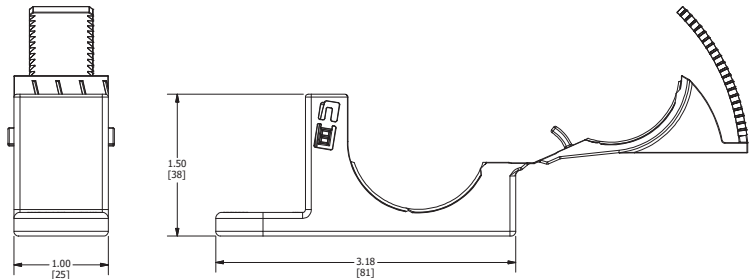

SUNGRIP™ Ratcheting P-Clamps				
<i>UV Resistant Polyamide Plastic Range taking P-Clamps</i>				
Catalog Number	Hardware Size	Mounting Design	Bundle Range	UL
WRPC14-150	1/4"	Bolt	.75 - 1.5"	UL1565 Pending
WRPC516-150	5/16"	Bolt		
WRPC38-150	3/8"	Bolt		
WRPC12-150	1/2"	Bolt		
WRPCFS6-150	N/A	Hook		

WCH - Wiley Cable Hanger Family

The WILEY Cable Hanger family is designed specifically to support cables via module frame mounting or wire management holes or secured around a tracker bolt in a fast, easy one-step hook application. With models oriented either straight on or at a 90° angle there are options for both traditional and bi-facial panels. The round cross-section of the hangers ensure the cable insulation is protected from chafing in high wind and with tracker application movement. Offered in either Stainless or galvanized steel construction, both provide a solution made to last.



WCH1 / WCH2

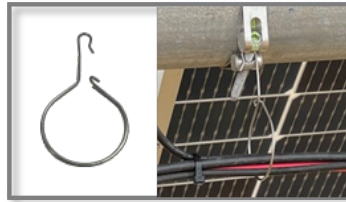

WCH2H1090



WCH2B10

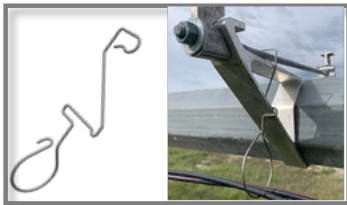

WCH2ATI



WCH2-90-15

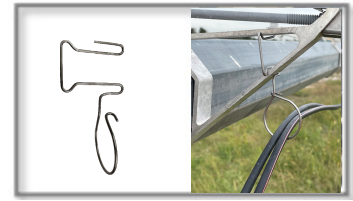

WCH15ATI / WCH15ATIGS

Catalog Number	Item #	Material	Bundle Diameter	Wire Quantity	Installation Location	Tracker System
WCH1	50091781	300 Series SS	1.0" [25.4mm]	Up to 8 PV wires	Mounting/Wire Mgmt Hole	N/A
WCH1GS	50120584	G90 Galvanized Steel	1.0" [25.4mm]	Up to 8 PV wires	Mounting/Wire Mgmt Hole	N/A
WCH2	20121393	300 Series SS	2.0" [50.8mm]	Up to 20 PV wires	Mounting/Wire Mgmt Hole	N/A
WCH2GS	50087252	G90 Galvanized Steel	2.0" [50.8mm]	Up to 20 PV wires	Mounting/Wire Mgmt Hole	N/A
WCH2B10	50119026	300 Series SS	2.0" [50.8mm]	Up to 20 PV wires	Tracker Bolt	GameChange and similar
WCHB210GS	50119125	G90 Galvanized Steel	2.0" [50.8mm]	Up to 20 PV wires	Tracker Bolt	GameChange and similar
WCH2H1090	50127837	300 Series SS	2.0" [50.8mm]	Up to 20 PV wires	Tracker Bolt	NexTracker™ (strap bracket) and similar
WCH2H1090GS	50125973	G90 Galvanized Steel	2.0" [50.8mm]	Up to 20 PV wires	Tracker Bolt	NexTracker™ (strap bracket) and similar
WCH2ATI	50123120	300 Series SS	2.0" [50.8mm]	Up to 20 PV wires	Tracker Mounting Bracket/Bolt	ATI and similar
WCH2ATIGS	50129338	G90 Galvanized Steel	2.0" [50.8mm]	Up to 20 PV wires	Tracker Mounting Bracket/Bolt	ATI and similar
WCH15ATI	50131965	300 Series SS	1.5" [38.1mm]	Up to 15 PV Wires	Tracker Bracket	ATI & Similar
WCH15ATIGS	50131966	G90 Galvanized Steel	1.5" [38.1mm]	Up to 15 PV Wires	Tracker Bracket	ATI & Similar
WCH2-90-15	50127833	300 Series SS	2.0" [50.8mm]	Up to 20 PV wires	Mounting/Wire Mgmt Hole or Tracker Bolt	NexTracker™ (U-Bolt) and similar
WCH2-90-15GS	50129116	G90 Galvanized Steel	2.0" [50.8mm]	Up to 20 PV wires	Mounting/Wire Mgmt Hole or Tracker Bolt	NexTracker™ (U-Bolt) and similar

Grounding Lugs

Tin-plated Copper, low-profile design

Constructed of corrosion resistant, tin-plated copper, the Wiley line of grounding lugs are high quality solutions for your grounding needs. The tin-plated lug assures minimum contact resistance and protection against corrosion. The low profile of the grounding lug allows it to be installed in a variety of positions with one solid or stranded copper wire (14 AWG to 6 AWG), or two copper wires (12 AWG to 10 AWG). Copper wire is secured by a 1/4-28 stainless steel screw, which is horizontal to the tang.

The WEEB® Grounding Lug is installed using stainless steel mounting hardware. When the hardware is tightened, the WEEB® washer's specialized teeth embed into coated (e.g. anodized, powder coated, etc.) metal or any electrically conductive metal to establish a reliable electrical connection.

The Wiley Grounding Lug is available unassembled, without installation hardware, and with standard hole sizes of 1/4" and 5/16" (M8). Perfect for galvanized steel applications or anywhere a WEEB® washer is not required.



WEEB® Lug

Features and Benefits:

- UL 467 Listed
- UL 2703 Listed
- Made of corrosion-resistant, tin-plated copper
- Design ensures a quick and easy installation
- Available:
 - With or without WEEB® washer technology
 - Assembled or unassembled
 - With or without installation hardware
- **No** surface preparation required on the rail or module
- Custom designs available upon request
- Reliability for use throughout the lifetime of the PV system

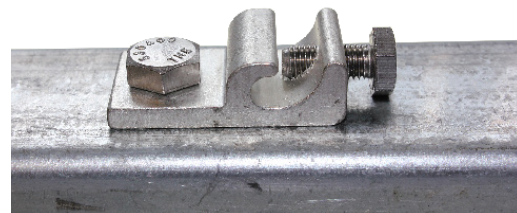

Wiley Lug

WEEB® Grounding Lug							
<i>Utilizes proven WEEB® washer technology to bite through most non-conductive coatings.</i>							
Catalog Number	Length inch [mm]	Width inch [mm]	Height inch [mm]	Hole Size inch [mm]	Mounting Hardware	Assembled	
WEEB-LUG-6.7	1.57 [40.00]	0.71 [18.00]	0.47 [12.00]	0.27 [6.76]	1/4" hardware included	N	
WEEB-LUG-6.7AS							Y
WEEB-LUG-8.0		0.86 [22.00]		0.32 [8.20]	M8 or 5/16" hardware not included	N	
WEEB-LUG-8.0AS					5/16" hardware included	Y	
WEEB-LUG-8.0UN					M8 or 5/16" hardware not included	N	
WEEB-LUG-15.8		0.71 [18.00]		0.41 [10.30]	M8 or 5/16" hardware not included	N	
WEEB-LUG-8.2						N	
WEEB-LUG-10.3		0.86 [22.00]			M10 or 3/8" hardware not included	N	
Wiley Grounding Lug							
<i>Perfect for galvanized steel applications or anywhere a WEEB® washer is not required.</i>							
WILEYLUG6.7	1.57 [40.00]	0.71 [18.00]	0.47 [12.00]	0.27 [6.76]	1/4" hardware not included	N	
WILEYLUG8.0		0.86 [22.00]		0.32 [8.20]	M8 or 5/16" hardware not included		
WILEYLUG8.2		0.709 [18.00]					
WILEYLUG15.8							

WEEB® Washer
Washer Electrical Equipment Bond

A revolution in bonding, WEEB® washers eliminate the need for older, more expensive grounding methods while also significantly reducing the amount of labor and materials used installations. No surface preparation or masking required.

Here's how it works: The WEEB® teeth pierce through most non-conductive coatings (e.g. anodization and powder coating) and embed into the underlying metal thus creating a bonding connection between the mounting surface and the coated metal component that it is installed on or between (e.g. equipment racks, cabinets, enclosures, cable tray, lugs, etc.). The result is excellent conductivity without oxidation — in solar it bonds the PV module frame with the metal racking structure. Essentially, the module and rail become one singular piece of metal, creating an electrical path to ground.

The WEEB® washers can be used in various applications like, but not limited to, coated equipment, fence, or cabinet bonding.



Features and Benefits:

- UL 467 Listed
- UL 2703 Recognized; UL 2703 Listed with certain systems
- Corrosion-resistant 304 stainless steel construction
- Reliability for use throughout the lifetime of the PV system
- Rated for outdoor use
- Multi-use
- Custom designs available upon request



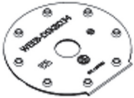

Integrated Bonding Clamp WEEB® Washers						
<i>WEEB® clamp washers easily snap or slide onto a mid-clamp and/or end-clamp for quick installation.</i>						
Line Image	Catalog Number	Length inch [mm]	Width inch [mm]	Height inch [mm]	Hole Size inch [mm]	Type
	WEEB-BMC-1	1.57 [40.00]	0.30 [7.60]	0.19 [4.83]	N/A	Clip On
	WEEB-M-KR	1.65 [41.90]	1.40 [35.80]	0.22 [5.50]	0.33 [8.38]	Slide On
	WEEB-MSNR516	1.50 [38.00]	1.57 [40.00]	0.25 [6.40]	0.43 [11.00]	Slide On

WEEB® Washers (Continued)

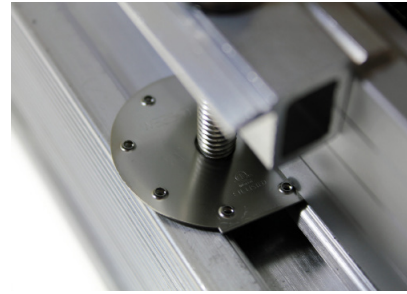

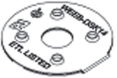
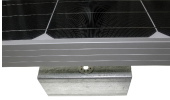
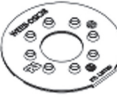
Universal WEEB® Disk Washers - Top Clamp Applications						
<i>Universal WEEB® Disk Washers allow for a wide range of compatibility across various racking systems and applications.</i>						
Line Image	Catalog Number	Length inch [mm]	Width inch [mm]	Height inch [mm]	Hole Size inch [mm]	Type
	WEEB-DSKBD34	1.57 [40.00]	1.57 [40.00]	0.07 [1.75]	0.32 [8.10]	Disk
	WEEB-DSK516-45	1.77 [45.00]	1.77 [45.00]	0.07 [1.75]	0.32 [8.10]	Disk



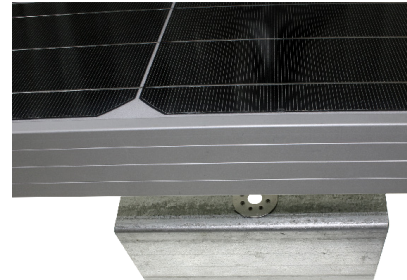

Universal WEEB® Disk Washers - Bottom Mount Applications						
<i>Universal WEEB® Disk Washers allow for a wide range of compatibility across various racking systems and applications.</i>						
Line Image	Catalog Number	Length inch [mm]	Width inch [mm]	Height inch [mm]	Hole Size inch [mm]	Type
	WEEB-DSK14	0.94 [24.10]	0.94 [24.10]	0.07 [1.75]	0.26 [6.75]	Disk
	WEEB-DSK516	1.01 [25.75]	1.01 [25.75]	0.07 [1.75]	0.32 [8.10]	Disk
	WEEB-DSK38	1.18 [30.88]	1.18 [30.88]	0.07 [1.75]	0.39 [9.80]	Disk
	WEEB-DSK12	1.39 [35.38]	1.39 [35.38]	0.07 [1.75]	0.51 [13.10]	Disk

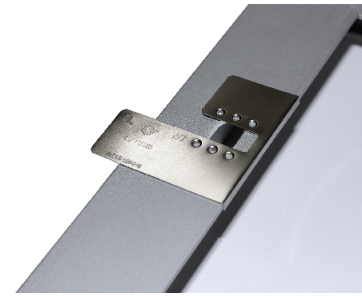

WEEB® Washers (Continued)

Universal Frame Bottom Mount WEEB® Washers						
<i>Universal WEEB® FBM washers are used in Solar PV bottom mount applications and can be applied to applications outside of solar.</i>						
Line Image	Catalog Number	Length inch [mm]	Width inch [mm]	Height inch [mm]	Hole Size inch [mm]	Type
	WEEB-FBM14	1.78 [45.25]	1.67 [42.50]	0.12 [3.20]	0.26 [6.75]	Clip On
	WEEB-FBM516	1.81 [46.00]	1.78 [45.25]	0.12 [3.20]	0.32 [8.10]	Clip On

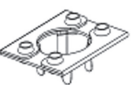
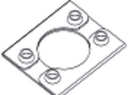

Bottom Mount WEEB® Washers						
<i>Bottom mounting WEEB® washers bond PV modules to the mounting structure at the module mounting holes; May have features that can be applied to applications outside of solar and secure the WEEB® at holes, slots, or directly to the module frame prior to installation.</i>						
Line Image	Catalog Number	Length inch [mm]	Width inch [mm]	Height inch [mm]	Hole Size inch [mm]	Type
	WEEB-UIR	0.71 [18.00]	0.71 [18.00]	0.03 [0.89]	0.26 [6.75]	Rigid
	WEEB-11.5	0.87 [22.10]	0.79 [20.20]	0.15 [4.00]	0.47 [12.00]	Rigid
	WEEB-9.5	0.71 [18.00]	0.59 [15.10]	0.12 [3.15]	0.39 [10.00]	Rigid
	WEEB-9.5NL	0.71 [18.00]	0.59 [15.10]	0.07 [1.74]	0.39 [10.00]	Rigid





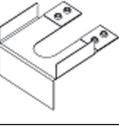
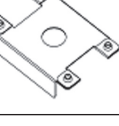
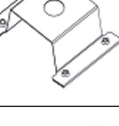
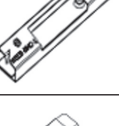
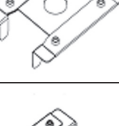
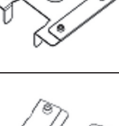
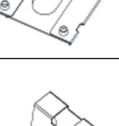
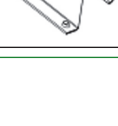

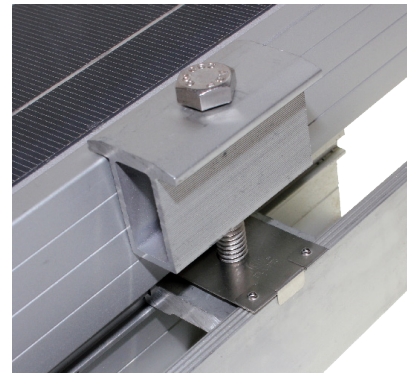
WEEB® Washers (Continued)

Top Clamp WEEB® Washers						
<i>Top clamp mounting WEEBs bond PV modules to the mounting structure at mid-clamp locations; May be pre-installed or slid onto mid-clamp hardware prior to the securing of modules and can be applied to applications outside of solar.</i>						
Line Image	Catalog Number	Length inch [mm]	Width inch [mm]	Height inch [mm]	Hole Size inch [mm]	Type
	WEEB-ADC	0.94 [24.00]	0.73 [18.66]	0.15 [3.75]	N/A	Clip On
	WEEB-ADR	1.34 [34.00]	1.18 [30.00]	0.72 [18.25]	0.38 [9.75]	Rigid
	WEEB-ASR	1.51 [38.40]	1.00 [25.50]	0.24 [6.12]	0.32 [8.14]	Rigid
	WEEB-ATF	1.68 [42.66]	1.26 [32.00]	0.40 [10.11]	0.31 [7.94]	Flexible
	WEEB-BMC-1	1.49 [38.00]	0.30 [7.60]	0.12 [2.97]	N/A	Clip On
	WEEB-CCR	1.59 [40.33]	1.26 [32.00]	0.24 [6.05]	0.33 [8.43]	Rigid
	WEEB-CCR-2	1.59 [40.33]	1.49 [38.00]	0.24 [6.05]	0.33 [8.43]	Rigid
	WEEB-CMC	1.28 [32.50]	1.15 [29.10]	0.19 [4.83]	0.31 [8.00]	Slotted
	WEEB-DHF	1.06 [27.00]	1.13 [28.60]	0.60 [15.09]	0.30 [7.69]	Flexible

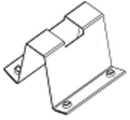
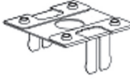
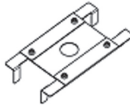
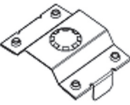

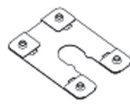

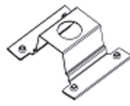

WEEB® Washers (Continued)

Top Clamp WEEB® Washers						
<i>Top clamp mounting WEEBs bond PV modules to the mounting structure at mid-clamp locations; May be pre-installed or slid onto mid-clamp hardware prior to the securing of modules and can be applied to applications outside of solar.</i>						
Line Image	Catalog Number	Length inch [mm]	Width inch [mm]	Height inch [mm]	Hole Size inch [mm]	Type
	WEEB-DMC	0.86 [22.04]	0.71 [18.00]	0.30 [7.62]	0.25 [6.35]	Rigid
	WEEB-DPF	1.06 [27.00]	1.13 [28.60]	0.59 [15.09]	0.30 [7.69]	Flexible
	WEEB-DPR	1.00 [25.41]	0.98 [25.00]	0.98 [25.00]	0.31 [8.00]	Rigid
	WEEB-ECR	2.16 [55.00]	1.17 [29.70]	0.28 [7.09]	0.33 [8.43]	Rigid
	WEEB-JJR	1.25 [31.75]	0.91 [23.00]	0.33 [8.51]	0.37 [9.40]	Flexible
	WEEB-KMC	1.67 [42.42]	1.22 [31.00]	0.18 [4.70]	0.37 [9.40]	Rigid
	WEEB-KSR	1.39 [35.26]	0.99 [25.20]	0.10 [2.55]	0.31 [8.00]	Slotted
	WEEB-OCR	1.36 [34.50]	1.16 [29.50]	0.12 [3.17]	0.33 [8.38]	Slotted
	WEEB-OSF	1.48 [37.70]	1.26 [32.00]	0.39 [10.03]	0.37 [9.55]	Flexible

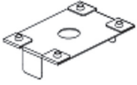
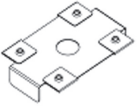
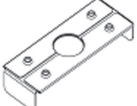

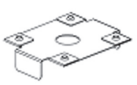
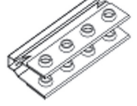

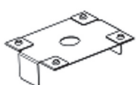

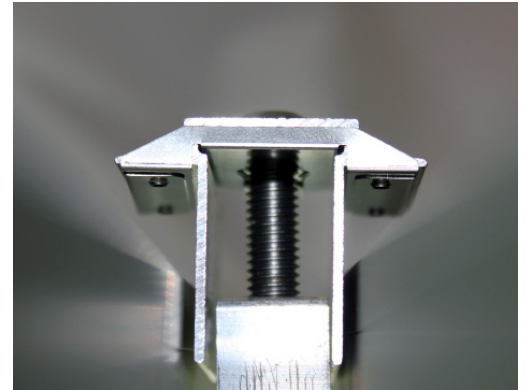
WEEB® Washers (Continued)

Top Clamp WEEB® Washers						
<i>Top clamp mounting WEEBs bond PV modules to the mounting structure at mid-clamp locations; May be pre-installed or slid onto mid-clamp hardware prior to the securement of modules and can be applied to applications outside of solar.</i>						
Line Image	Catalog Number	Length inch [mm]	Width inch [mm]	Height inch [mm]	Hole Size inch [mm]	Type
	WEEB-PMC	1.58 [40.11]	1.10 [28.00]	0.25 [6.37]	0.31 [7.94]	Rigid
	WEEB-RPR	1.47 [37.41]	1.14 [28.85]	0.27 [6.88]	0.32 [8.20]	Rigid
	WEEB-SCR	1.72 [43.70]	0.65 [16.51]	0.28 [7.11]	0.37 [9.53]	Rigid
	WEEB-SMC-2	1.50 [38.10]	0.98 [25.00]	0.33 [8.38]	0.32 [8.20]	Slotted
	WEEB-SSF	1.33 [33.86]	0.59 [15.00]	0.67 [16.94]	0.34 [8.48]	Flexible
	WEEB-SSR	1.70 [43.20]	1.35 [34.30]	0.27 [6.86]	0.37 [9.53]	Rigid
	WEEB-STC	0.94 [24.00]	0.42 [10.58]	0.17 [4.42]	N/A	Rigid
	WEEB-UMC	1.49 [37.91]	0.71 [18.00]	0.29 [7.34]	0.25 [6.35]	Rigid
	WEEB-WMC	1.63 [41.30]	1.31 [33.50]	0.34 [8.61]	0.31 [7.94]	Rigid



WEEB® Washers (Continued)

Replacement WEEB® Washers						
Replacement WEEB® Washers for WEEB-LUG and WEEB-BNDJMP product lines.						
Line Image	Catalog Number	Length inch [mm]	Width inch [mm]	Height inch [mm]	Hole Size inch [mm]	Type
	WEEB-15.8	1.37 [34.85]	0.71 [18.00]	0.17 [4.27]	0.32 [8.20]	Rigid
	WEEB-6.7	1.37 [34.35]	0.71 [18.00]	0.17 [4.27]	0.26 [6.53]	Rigid
	WEEB-8.0	1.45 [36.75]	0.86 [22.00]	0.17 [4.27]	0.32 [8.20]	Rigid
	WEEB-8.2	1.37 [34.85]	0.71 [18.00]	0.17 [4.27]	0.32 [8.20]	Rigid



Telecom WEEB® Washer Washer Electrical Equipment Bond

The Telecom WEEB® Washer design utilizes patented WEEB® Washer teeth eliminating the need to remove nonconductive coatings (e.g. anodization and powder coat) when making bonding connections. The teeth pierce through most nonconductive coatings and embed into the underlying metal creating a bonding connection between the lug and the coated metal component that it is installed on (e.g. equipment racks, cabinets, enclosures, cable tray, etc.). Eliminating the step to remove nonconductive coatings is a huge time savings in addition to creating a cleaner work environment and most important, prevent improper coating removal techniques that can lead to poor connections.

Features and Benefits:

- Made from corrosion resistant 304 stainless steel for outstanding durability and performance
- Eliminates the need for surface preparation and oxide inhibitor
- Detailed manual specifying proper hardware, torque, and mounting information is available upon request
- UL 467 Recognized for grounding and bonding equipment
- Custom grounding and bonding solutions available upon request

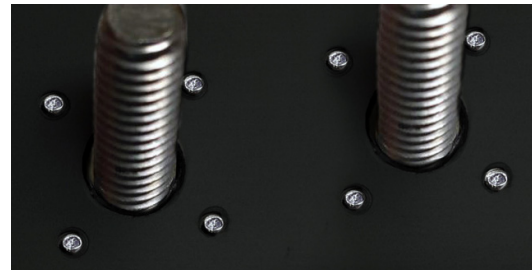

Two Hole Telecom WEEB® Washer							Stainless Steel Hardware Kits (TMH-SS) - Sold Separately*									
Catalog #	Compatible TWO-hole HYLUG™ Family	Conductor		Hex Head Bolt		Stud Hole Spacing	Catalog #	Bolt			Flat Washer	Split Washer	Hex Nut	Working Range	Installation Torque (in-lbs)	
		Wire Type	Wire Range	Size	Torque (in-lbs)			Size	Length	Qty						
WEEB-2TC14	YA-2TC14	Code	#14-2 AWG	1/4	100	5/8"	TMH262SS	1/4-20"	2	4	2	2	0.09-0.34	100		
	YA-L-2TC14						TMH263SS								0.75	
	YAZ-2TC14						TMH264SS								1.00	
	YAZV-2TC14						TMH265SS								1.25	
	YGA-2TC14	Flex	#8-2 AWG				TMH266SS								1.50	0.59-0.84
	YA-L-2TC14-FX						TMH267SS								1.75	0.84-1.09
	YAV-L-2TC14-FX						TMH268SS								2.00	0.19-0.44
	YAZ-2TC14-FX						TMH269SS								1.00	0.44-0.69
YAZV-2TC14-FX	TMH270SS	1.25	0.69-0.94													
WEEB-2TC38	YA-2TC38	Code	#14-2 AWG	3/8	240	1"	TMH271SS	3/8-16"	2	4	2	2	0.94-1.19	240		
	YA-L-2TC38						TMH272SS								1.50	
	YAZ-2TC38						TMH273SS								1.75	
	YAZV-2TC38						TMH274SS								2.00	
	YGA-2TC38	Flex	#8-2 AWG				TMH275SS								1.00	1.19-1.44
	YA-L-2TC38-FX						TMH276SS								1.25	0.19-0.44
	YAV-L-2TC38-FX						TMH277SS								1.50	0.44-0.69
	YAZ-2TC38-FX						TMH278SS								1.75	0.69-0.94
YAZV-2TC38-FX	TMH279SS	2.00	0.94-1.19													

Telecom WEEB® Washer; Single Hole
Washer Electrical Equipment Bond

The WILEY Telecom WEEB® (Washer, Electrical Equipment Bond) Washer is a powder coat and paint penetrating, contact-enhancing washer used between connectors and equipment frames, cabinets and other painted metallic surfaces to be bonded.

The WEEB® Washer teeth eliminate the need to remove non-conductive coatings (e.g. paint and powder coat) when making a bonding connection. The WEEB® teeth pierce through most non-conductive coatings and embed into the underlying metal thus creating a bonding connection between the lug and the coated metal component that it is installed on (e.g. equipment racks, cabinets, enclosures, cable tray, etc.). Not having to remove non-conductive coatings will save on installation time, create a cleaner work environment, and most importantly, prevent improper coating removal techniques that can lead to poor connections. WEEB® Washers also help eliminate unwanted rotation of the lug keeping your connections secure and properly bonded.

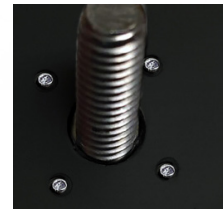

Features and Benefits:

- For bonding lug to underlying coated metal surfaces in various applications (e.g. equipment racks, cabinets, servers, enclosures, cable trays, etc.)
- For use with 1-Hole HYLUG™ or equivalent connectors
- Wire Range: #14 to #6 AWG
- Coating Types: Paint, Powder Coating and similar
- Coating Thickness: Maximum 5 Mils
- WEEB-TC14: 1/4" Stud
- WEEB-TC38: 3/8" Stud
- Refer to detailed manual specifying proper hardware, torque, mounting information, and applicable lugs

WEEB® Washer	Compatible 1-Hole HYLUG™ Family	Conductor		Hex Head Bolt		Installation Tooling
		Wire Type	Wire Range	Size	Torque (in-lbs)	
WEEB-TC14	YA-TC14	Code	#14-#6 AWG	1/4"	100	BTW30150
	YA-L-TC14	Code	#14-#6 AWG			
	YAZ-TC14	Code	#14-#6 AWG			
	YAZV-TC14	Code	#14-#6 AWG			
	YGA-TC14	Code	#8-#6 AWG			
	YA-L-TC14-FX	Flex	#8-#6 AWG			
	YAV-L-TC14-FX	Flex	#8-#6 AWG			
	YAZ-TC14-FX	Flex	#8-#6 AWG			
	YAZV-TC14-FX	Flex	#8-#6 AWG			
WEEB-TC38	YA-TC38	Code	#14-#6 AWG	3/8"	240	BTW150750
	YA-L-TC38	Code	#14-#6 AWG			
	YAZ-TC38	Code	#14-#6 AWG			
	YAZV-TC38	Code	#14-#6 AWG			
	YGA-TC38	Code	#8-#6 AWG			
	YA-L-TC38-FX	Flex	#8-#6 AWG			
	YAV-L-TC38-FX	Flex	#8-#6 AWG			
	YAZ-TC38-FX	Flex	#8-#6 AWG			
	YAZV-TC38-FX	Flex	#8-#6 AWG			

Bonding Jumper Tin-plated Braided Copper

Constructed of corrosion resistant, tin-plated, braided copper, the Wiley line of bonding jumpers are high quality solutions for your system.

The WEEB® Bonding Jumper is used to create an electrical connection between two pieces of coated (e.g. anodized, powder coated, etc.) metal or any electrically conductive material. This maintains electrical continuity over long spans or air gaps between metal structures.

The Wiley Bonding Jumper is used to create an electrical connection between two pieces of galvanized steel or other uncoated electrically conductive metals.

Features and Benefits:

- UL 467 Listed
- UL 2703 Listed
- Corrosion resistant
- Equivalent to #6 AWG copper wire
- Available:
 - With or without WEEB® washer technology
 - Assembled or unassembled
 - With or without installation hardware
- In-stock standard lengths from 6" to 36" (custom lengths available upon request)
- Reliability for use throughout the lifetime of the PV system

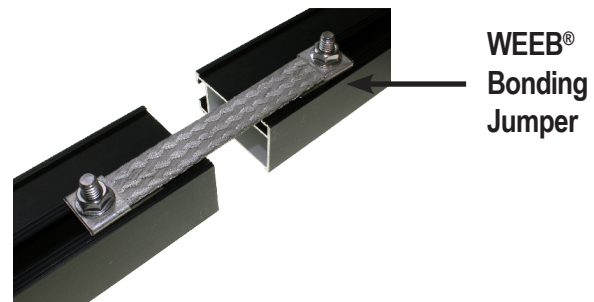
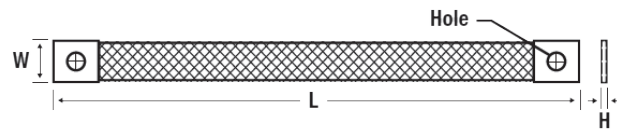

WEEB® Bonding Jumpers:		Utilizes proven WEEB® washer technology to bite through any non-conductive coatings.					
Catalog Number	Length inch [mm]	Width inch [mm]	Height inch [mm]	Hole Size inch [mm]	Gauge	Hardware	Assembled
WEEB-BNDJMP6.7	9.00 [228.60]	0.71 [18.00]	0.08 [2.03]	0.26 [6.53]	6 AWG	WEEB® washer included; 1/4" mounting hardware included	N
WEEB-BNDJMP6.7AS						WEEB® washer included; 1/4" mounting hardware included	Y
WEEB-BNDJMP8.0	6.00 [152.40]	0.87 [22.00]	0.10 [2.54]	0.32 [8.20]		WEEB® washer included; M8 or 5/16" mounting hardware NOT included	N
WEEB-BNDJMP8.0AS						WEEB® washer included; M8 or 5/16" mounting hardware included	Y
WEEB-BNDJMP8.2	10.00 [254.00]	0.71 [18.00]	0.08 [2.03]	0.32 [8.20]		WEEB® washer included; M8 or 5/16" mounting hardware NOT included	N
WEEB-BNDJMP8.2MS						WEEB® washer included; M8 flat washer included	N
WEEB-BNDJMP9	9.00 [228.60]	0.71 [18.00]	0.08 [2.03]	0.26 [6.53]		WEEB® washer included; 1/4" mounting hardware NOT included	N
WEEB-BNDJMP12						WEEB® washer included; 1/4" mounting hardware NOT included	N
WEEB-BNDJMP12AS	12.00 [304.80]	0.71 [18.00]	0.08 [2.03]	0.26 [6.53]		WEEB® washer included; 1/4" mounting hardware included	Y
WEEB-BNDJMP18						WEEB® washer included; 1/4" mounting hardware NOT included	N
WEEB-BNDJMP18AS	18.00 [457.20]	0.71 [18.00]	0.08 [2.03]	0.26 [6.53]		WEEB® washer included; 1/4" mounting hardware included	Y
WEEB-BNDJMP24						WEEB® washer included; 1/4" mounting hardware NOT included	N
WEEB-BNDJMP24AS	24.00 [609.80]	0.71 [18.00]	0.08 [2.03]	0.26 [6.53]		WEEB® washer included; 1/4" mounting hardware included	Y
WEEB-BNDJMP36						WEEB® washer included; 1/4" mounting hardware NOT included	N
WEEB-BNDJMP36AS	36.00 [914.40]	0.71 [18.00]	0.08 [2.03]	0.26 [6.53]		WEEB® washer included; 1/4" mounting hardware included	Y

Bonding Jumpers (Continued)

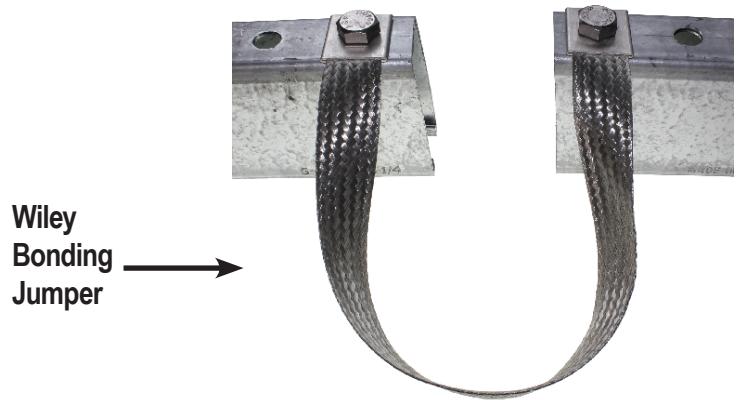

Wiley Bonding Jumpers:		<i>Perfect for tracker applications, galvanized steel or anywhere a WEEB® washer is not required.</i>				
Catalog Number	Length	Width	Height	Hole Size	Gauge	Hardware Size
WILEYBRAID6	6.00 [152.40]	0.71 [18.00]	0.08 [2.03]	0.26 [6.53]	6 AWG	M6 or 1/4" No WEEB® washer or mounting hardware included
WILEYBRAID9	9.00 [228.60]					
WILEYBRAID12	12.00 [304.80]					
WILEYBRAID18	18.00 [457.20]					
WILEYBRAID24	24.00 [609.80]					
WILEYBRAID30	30.00 [762.00]					
WILEYBRAID36	36.00 [914.40]					
WILEYBRAID6-516	6.00 [152.40]	0.71 [18.00]	0.08 [2.03]	0.32 [8.20]	6 AWG	M8 or 5/16" No WEEB® washer or mounting hardware included
WILEYBRAID9-516	9.00 [228.60]					
WILEYBRAID12-516	12.00 [304.80]					
WILEYBRAID18-516	18.00 [457.20]					
WILEYBRAID24-516	24.00 [609.80]					
WILEYBRAID30-516	30.00 [762.00]					
WILEYBRAID36-516	36.00 [914.40]					
WILEYBRAID6-38	6.00 [152.40]	0.87 [22.00]	0.14 [3.65]	0.40 [10.20]	6 AWG	M10 or 3/8" No WEEB® washer or mounting hardware included
WILEYBRAID9-38	9.00 [228.60]					
WILEYBRAID12-38	12.00 [304.80]					
WILEYBRAID18-38	18.00 [457.20]					
WILEYBRAID24-38	24.00 [609.80]					
WILEYBRAID30-38	30.00 [762.00]					
WILEYBRAID36-38	36.00 [914.40]					

Bonding Jumpers (Continued)

Wiley Bonding Jumpers: <i>Perfect for tracker applications, galvanized steel or anywhere a WEEB® washer is not required.</i>						
Catalog Number	Length	Width	Height	Hole Size	Gauge	Hardware Size
WILEYBRAID6-12	6.00 [152.40]	1.20 [30.48]	0.12 [3.02]	0.56 [14.22]	6 AWG	M12 or 1/2" No WEEB® washer or mounting hardware included
WILEYBRAID8-12	8.00 [203.20]					
WILEYBRAID10-12	10.00 [254.00]					
WILEYBRAID12-12	12.00 [304.80]					
WILEYBRAID18-12	18.00 [457.20]					
WILEYBRAID24-12	24.00 [609.80]					
WILEYBRAID30-12	30.00 [762.00]					
WILEYBRAID36-12	36.00 [914.40]					
WILEYBRAID6-916	6.00 [152.40]	1.20 [30.48]	0.12 [3.02]	0.63 [15.88]	6 AWG	M14 or 9/16" No WEEB® washer or mounting hardware included
WILEYBRAID8-916	8.00 [203.20]					
WILEYBRAID10-916	10.00 [254.00]					
WILEYBRAID12-916	12.00 [304.80]					
WILEYBRAID18-916	18.00 [457.20]					
WILEYBRAID24-916	24.00 [609.80]					
WILEYBRAID30-916	30.00 [762.00]					
WILEYBRAID36-916	36.00 [914.40]					
WILEYBRAID6-34	6.00 [152.40]	1.20 [30.48]	0.12 [3.02]	0.81 [20.45]	6 AWG	M20 or 3/4" No WEEB® washer or mounting hardware included
WILEYBRAID8-34	8.00 [203.20]					
WILEYBRAID10-34	10.00 [254.00]					
WILEYBRAID12-34	12.00 [304.80]					
WILEYBRAID18-34	18.00 [457.20]					
WILEYBRAID24-34	24.00 [609.80]					
WILEYBRAID30-34	30.00 [762.00]					
WILEYBRAID36-34	36.00 [914.40]					

WEEB® Rope Lay Jumper (WEEB-RLJ) Flexible Bonding Jumper Solutions

The WEEB® Rope Lay Jumper is the optimal solution for creating a bonding connection between applications involving moving components with coated surfaces. The WEEB-RLJ type jumpers are flexible in all directions and can be mounted to any coated flat surface creating an immediate bonded connection without the need to remove nonconductive coating. The rope lay jumper is made from tin plated copper stranding and crimped into a high-quality BURNDY® lug. It meets the requirements of both UL467 and UL2703. The WEEB Washer's patented WEEB® Washer teeth pierce through most nonconductive coatings and embed into the underlying metal creating a bonding connection between the lug and the coated metal component that it is installed on. Not having to remove nonconductive coatings will save on installation time, create a cleaner work environment and most importantly, prevent improper coating removal techniques that can lead to poor connections.

At a standard size equivalent to 6 AWG conductor, engineers and installers can be confident in meeting and exceeding bonding requirements in most applications.

The WEEB-RLJ is available with a variety of mounting hole sizes and in three standard lengths. Adding flexibility to both the installation process and applications requirements, custom lengths and mounting configurations are available upon request.



Features and Benefits:

- Bonding connection between moving and stationary coated components with extremely flexible conductor stranding
- Standard mounting geometry and hardware requirements allow quick and easy installation
- Tin plated copper construction ensures durability against the elements and provides the environmental stability required for installation longevity
- The WEEB® Washer is made from corrosion resistant 304 stainless steel which provides outstanding durability and performance
- Offered in a variety of lengths and mounting hardware sizes - custom configurations available upon request
- Listed UL467 and UL2703

Part Key		
Line	WEEB-RLJ	Rope Lay Jumper with WEEB® Washer
AWG	6C	#6 Conductor
Length	6	6" / 152mm
	12	12" / 305mm
	18	18" / 457mm
Mounting Hole	14	1/4" Hardware
	516	5/16" Hardware
	38	3/8" Hardware

Catalog Number	AWG Size	Length	Mounting Hole Dia.	Hardware Equivalent
WEEB-RLJ6C6-14	#6	6" / 152mm	.27" / 6.8mm	1/4"
WEEB-RLJ6C12-14	#6	12" / 305mm	.27" / 6.8mm	1/4"
WEEB-RLJ6C18-14	#6	18" / 457mm	.27" / 6.8mm	1/4"
WEEB-RLJ6C6-516	#6	6" / 152mm	.33" / 8.4mm	5/16"
WEEB-RLJ6C12-516	#6	12" / 305mm	.33" / 8.4mm	5/16"
WEEB-RLJ6C18-516	#6	18" / 457mm	.33" / 8.4mm	5/16"
WEEB-RLJ6C6-38	#6	6" / 152mm	.39" / 9.9mm	3/8"
WEEB-RLJ6C12-38	#6	12" / 305mm	.39" / 9.9mm	3/8"
WEEB-RLJ6C18-38	#6	18" / 457mm	.39" / 9.9mm	3/8"

Wiley Rope Lay Jumper (WILEY-RLJ) Flexible Bonding Jumper Solutions

The Wiley Rope Lay Jumper is the optimal solution for bonding applications involving moving components. The WILEY-RLJ type jumpers are flexible in all directions and can be mounted to any flat surface. Made from tin plated copper stranding and crimped into a high-quality BURNDY lug, the rope lay jumper meets requirements of both UL467 and UL2703. At a standard size equivalent to 6 AWG conductor, engineers and installers can be confident in meeting and exceeding bonding requirements in most applications. The WILEY-RLJ jumpers are available with a variety of mounting hole sizes and in three standard lengths. Adding flexibility to both the installation process and applications requirements, custom lengths and mounting configurations are available upon request.



Features and Benefits:

- Bonding connection between moving and stationary coated components with extremely flexible conductor stranding
- Standard mounting geometry and hardware requirements allow quick and easy installation
- Tin plated copper construction ensures durability against the elements and provides the environmental stability required for installation longevity
- Offered in a variety of lengths and mounting hardware sizes - custom configurations available upon request
- Listed UL467 and UL2703

Part Key		
Line	WILEY-RLJ	Standard Rope Lay Jumper
AWG	6C	#6 Conductor
Length	6	6" / 152mm
	12	12" / 305mm
	18	18" / 457mm
Mounting Hole	14	1/4" Hardware
	516	5/16" Hardware
	38	3/8" Hardware

Catalog Number	AWG Size	Length	Mounting Hole Dia.	Hardware Equivalent
WILEY-RLJ6C6-14	#6	6" / 152mm	.27" / 6.8mm	1/4"
WILEY-RLJ6C12-14	#6	12" / 305mm	.27" / 6.8mm	1/4"
WILEY-RLJ6C18-14	#6	18" / 457mm	.27" / 6.8mm	1/4"
WILEY-RLJ6C6-516	#6	6" / 152mm	.33" / 8.4mm	5/16"
WILEY-RLJ6C12-516	#6	12" / 305mm	.33" / 8.4mm	5/16"
WILEY-RLJ6C18-516	#6	18" / 457mm	.33" / 8.4mm	5/16"
WILEY-RLJ6C6-38	#6	6" / 152mm	.39" / 9.9mm	3/8"
WILEY-RLJ6C12-38	#6	12" / 305mm	.39" / 9.9mm	3/8"
WILEY-RLJ6C18-38	#6	18" / 457mm	.39" / 9.9mm	3/8"

Wiley Clamping Solutions Mid-Clamps

Our universal mid-clamp and adjustable end clamp designs accommodate various module thicknesses. The Wiley Mid-Clamp uses proven WEEB® technology for integrated bonding as well as a quick and easy installation.

Features and Benefits:

- UL 467 Listed
- UL 2703 Recognized
- Low profile design
- Increased inspectability
- Custom designs and finishes available upon request
- Reliability for use throughout the lifetime of the PV system



Stainless Steel Integrated Bonding Mid-Clamp					
<i>304 Stainless Steel integrated bonding mid-clamp for module-to-module bonding.</i>					
Catalog Number	Length inch [mm]	Width inch [mm]	Height inch [mm]	Hole Size inch [mm]	Module Spacing
BMCSS8W17	1.91 [48.61]	1.32 [33.58]	0.48 [12.30]	0.33 [8.50]	0.67 [17.00]
BMCSS6W17	1.91 [48.61]	1.32 [33.58]	0.48 [12.30]	0.26 [6.60]	0.67 [17.00]

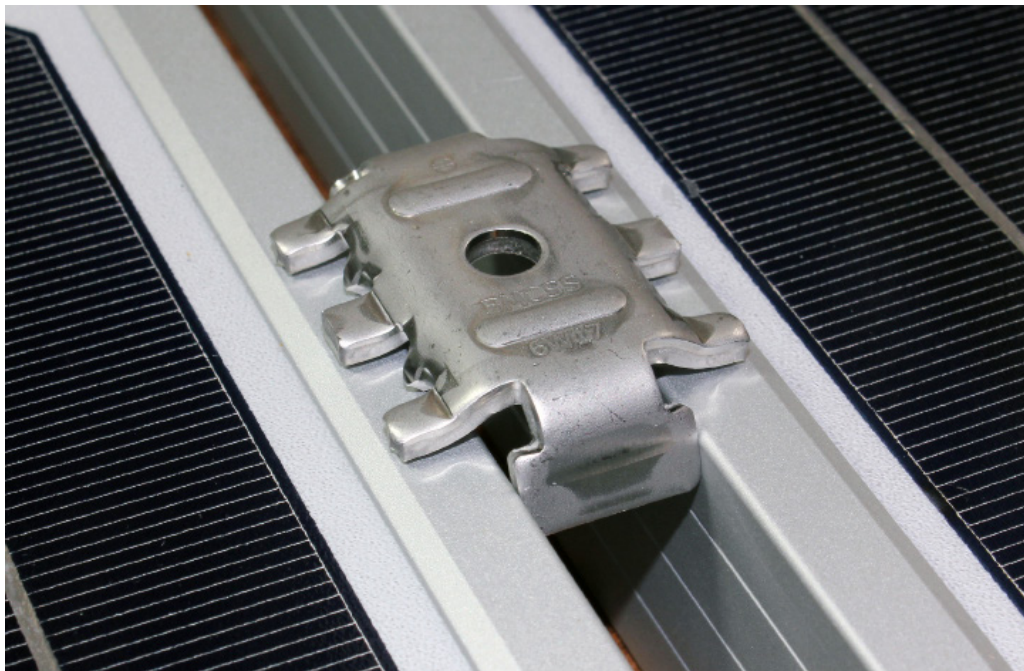

This page left intentionally blank.

Table of Contents

Introduction	F-2
PENETROX™ Oxide Inhibitor	
How to Install Connectors.....	F-2
Overview of Different Types	F-3
Technical Information	F-4
Properties and Ordering Information.....	F-5
Recommended Tightening Torque	F-6
DURIUM™ Silicon Bronze Hardware	
Bolts.....	F-6
Nuts.....	F-7
Flat Washer	F-7
Split Lockwashers.....	F-7
Internal Lockwashers	F-7
Aluminum Hardware	
Bolts.....	F-8
Nuts.....	F-8
Flat Washer	F-8
Split Lockwasher	F-8
Galvanized Steel Hardware	
Bolts.....	F-9
Nuts.....	F-9
Flat Washers.....	F-9
Internal Tooth Lockwashers.....	F-9
Stainless Steel Hardware	
Bolts.....	F-10
Nuts.....	F-10
Split Lockwasher	F-10
Flat Washers.....	F-10
Belleville Washers.....	F-11
Hardware Kits	
DURIUM™ Silicon Bronze TMH	F-12
Stainless Steel TMH-SS.....	F-12
Covers for Transformer Connectors.....	F-13
WIREMIKE™ Stainless Steel Wire Micrometer	F-14

Most frequently ordered catalog numbers are highlighted in BLUE

Introduction

BURNDY wiring accessories have been designed to supplement and enhance BURNDY connection selection and use. All have been designed and engineered for easy installation and long life, reflecting over 90 years of experience and resulting contributions of the electrical industry.

PENETROX™

How to Install Connectors

1. Select the right connector.

Always use an aluminum connector for aluminum or copper conductor. Choose a connector that's marked for the wire size you're using. Never use a copper connector on aluminum conductor.

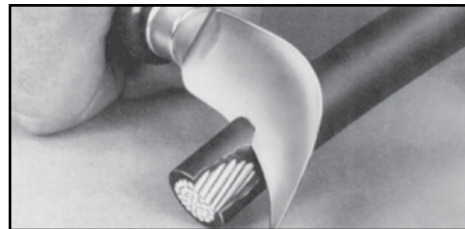

2. Strip carefully.

Remove the insulation without nicking the wire.

3. Brush thoroughly.

Always wire-brush the stripped portion of the wire. An unplated terminal pad, and the surface to which the terminal will be attached should also be wire-brushed.

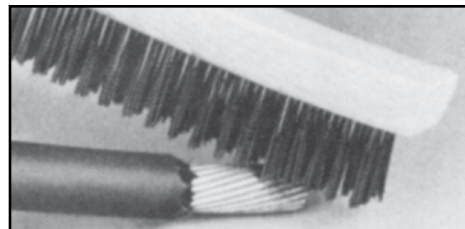

4. Apply PENETROX™

For mechanical connectors, apply PENETROX™ joint compound liberally to the conductor to prevent the formation of surface oxides once the connection is made. Also apply PENETROX™ to any terminal pad.



5. Tighten completely.

For mechanical connectors, use wrench or screwdriver to securely tighten the aluminum connectors, as recommended by BURNDY.

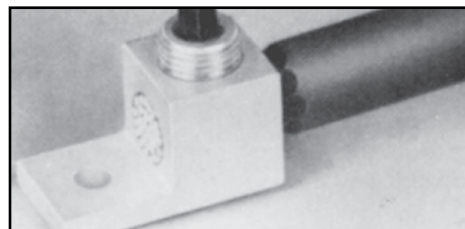

6. Crimp.

For compression connectors, choose the right die and the right tool. Insert the wire completely and make the recommended number of crimps.

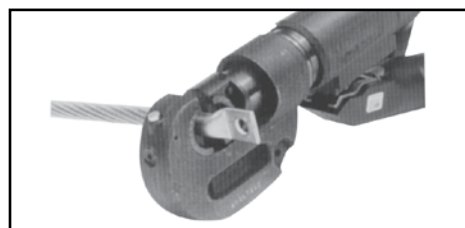

PENETROX™ TYPES A, A-13, E, HT

Oxide Inhibiting Joint Compounds



PENETROX™ oxide inhibiting compounds product low initial contact resistance, seal out air and moisture, prevent oxidation or corrosion, exhibit superior weathering characteristics, are usable over wide temperature ranges, and provide a high conductivity "gas-tight" joint. All PENETROX™ compounds contain homogeneously suspended metal particles. The suspended metal particles assist in penetrating thin oxide films, act as electrical "bridges" between conductor strands, aid in gripping the conductor, improve electrical conductivity and enhance the integrity of the connection.

The specially formulated PENETROX™ compounds are for use with compression and bolted connectors providing an improved service life for both copper and aluminum connections. Additionally, the nontoxic compounds are an excellent lubricant for threaded applications, reducing galling and seizing.



PENETROX™ with brush lid

All types of PENETROX™ are available in an 8 oz. bottle with a brush lid for ease of application.



PENETROX™ A

PENETROX A is a natural (petroleum) base compound with evenly suspended zinc particles. It is recommended for aluminum to aluminum, aluminum to copper connections and aluminum conduit threads. It is not recommended for use with rubber or polyethylene insulated conductors. UL listed to 600V.



PENETROX™ A13

PENETROX™ A13 is a synthetic base compound with evenly suspended zinc particles. It is recommended for aluminum to aluminum, aluminum to copper connections plus aluminum conduit threads. It is compatible with rubber, polyethylene and other insulating materials. UL Listed for all voltages.



PENETROX™ E

PENETROX™ E is a synthetic base compound with evenly suspended copper particles. It is recommended for copper to copper, copper threads and all grounding applications. UL Listed.



PENETROX™ HT

PENETROX™ HT is a synthetic silicone based compound with evenly suspended zinc particles and nickel-aluminum alloy particles. It is recommended for aluminum to aluminum connections. It is compatible with rubber. Designed for use with High Temperature ACSS and ACCC connectors. Not UL Listed.



PENACARTRIDGE

PENACARTRIDGE is a 1 lb. cartridge filled with PENETROX-A. It's designed to fit standard caulking guns for easy insertion into transmission and distribution connectors. Additionally, this packaging design provides a convenient method for applying PENETROX™ to many different applications.



PENETROX™ TYPES A, A13, E, HT



Technical Information

PENETROX™ oxide inhibiting compounds product low initial contact resistance, seal out air and moisture, prevent oxidation or corrosion, exhibit superior weathering characteristics, are usable over wide temperature ranges, and provide a high conductivity “gas-tight” joint. All PENETROX™ compounds contain homogeneously suspended metal particles. The suspended metal particles assist in penetrating thin oxide films, act as electrical “bridges” between conductor strands, aid in gripping the conductor, improve electrical conductivity and enhance the integrity of the connection.

The specially formulated PENETROX™ compounds are for use with compression and bolted connectors providing an improved service life for both copper and aluminum connections. Additionally, the nontoxic compounds are an excellent lubricant for threaded applications, reducing galling and seizing.



PENETROX™ Type	Aluminum to Aluminum	Aluminum to Copper	Copper to Copper	Aluminum Conduit Threads	Copper Conduit Threads
PENETROX A	X	X		X	
PENETROX A13	X	X		X	
PENETROX E			X		X
PENETROX HT	X				

See below for more details on the different types of PENETROX

PENETROX™ Type A

PENETROX™ A consists of a natural (petroleum) base vehicle in which zinc particles are suspended. For aluminum to aluminum, aluminum to copper applications and aluminum conduit threads. It is not recommended for use with rubber and polyethylene insulated conductors. UL Listed to 600 volts.

PENETROX™ Type A13

PENETROX A13 consists of a non-petroleum base vehicle in which zinc particles are suspended. Recommended for aluminum to aluminum, aluminum to copper applications and aluminum conduit threads. Compatible with insulating materials such as rubber, or polyethylene. UL Listed and recommended for all voltages.

PENETROX™ Type E

PENETROX E consists of a non-petroleum base vehicle in which copper granules are suspended. Recommended for copper to copper applications, grounding and for use on copper conduit threads. UL Listed to 600 volts.

PENETROX™ Type HT

PENETROX HT consists of a non-petroleum base vehicle in which zinc and nickel-aluminum particles are suspended. Recommended for use with aluminum to aluminum High Temperature rated ACSS and ACCC conductors. Not UL Listed.

Easy to apply:

1. Scratch brush the conductor surfaces until bright and clean.
2. Immediately apply PENETROX™ to the conductive surfaces.
3. For EHV applications, remove all excess PENETROX™ after installation is complete.



38-0305-00 Wire Brush

Shelf Life

When stored in its original container in cool (under 100°F) dry environment, PENETROX™ oxide inhibiting compound will remain workable and functional for 5 years from the Date of Manufacture (MO) marked on the container.

PENETROX™ TYPES A, A13, E, HT

Properties and Ordering Information

PROPERTIES OF PENETROX™

Property	Value PENETROX™ Definition	PENETROX™ HT	PENETROX™ E & A13	PENETROX™ A
Penetration (Unworked)	The value in accordance to ASTM D217 indicates the consistency of a grease. The higher the number, the softer the grease.	240	250	230
Dropping Point (Minimum)	The temperature at which the grease passes from the semi-solid to a liquid state under test conditions.	>580° F	350° F	230° F
Pour Point (Maximum)	The lowest temperature at which the compound will flow. Pour point is the lubricant's ability to perform in cold conditions.	-58° F	-40° F	-15° F

* MSDS sheets available through customer service.

ORDERING INFORMATION

Catalog Number				Container Type	Container Size
PENETROX™ A	PENETROX™ A-13	PENETROX™ E	PENETROX™ HT †		
PENA1/2	—	—	—	Tube	1/2 oz.
PENA4	PENA134	PENE4	PENHT4	Squeeze Bottle	4 oz.
P8A	PENA138	PENE8	PENHT8	Squeeze Bottle	8 oz.
PENA8BLB	PENA138BLB	PENE8BLB	PENHT8BLB	Bottle with Brush Lid	8 oz.
PENACARTRIDGE	PENA13CARTRIDGE	—	PENHT1LB	Cartridge	1 lb.*
PENAQT	PENA13QT	PENEQT	—	Plastic Tub	1 Quart
PENAGAL	PENA13GAL	PENEGAL	PENHTGAL	Can	1 Gallon
PENA5GAL	PENA135GAL	PENE5GAL	—	Pail	5 Gallons
PENA55GAL	PENA1355GAL	PENE55GAL	—	Drum	55 Gallons

* 1 lb. cartridge will fit standard caulking guns.

† Not UL Listed.

Recommended Tightening Torque

The hardware used in connectors must be compatible with the connector material, have high mechanical strength and be corrosion resistant and correspond to NEMA recommendations.

Copper alloy connectors have hardware made of DURIUM™, which is the BURNDY trade name for silicon bronze alloy ASTMB99 type B. This material was first introduced by BURNDY® in 1927 for use in outdoor construction, and today, is the standard throughout the industry.

Aluminum connectors generally have aluminum alloy hardware. The bolts are 2024T4 and anodized to resist corrosion. The nuts are 6061T6, which is resistant to corrosion and does not require anodizing. Both nuts and bolts are lubricated to eliminate galling and to provide consistent clamping forces.

DURIUM™ and Steel Hardware		Aluminum Hardware	
Bolt Size	Rec. Torque (Inch Pounds)	Bolt Size	Rec. Torque (Inch Pounds)
1/4 - 20	80	1/2 - 13	300
5/16 - 18	180	5/8 - 11	480
3/8 - 16	240	3/4 - 10	650
1/2 - 13	480		
5/8 - 11	660		
3/4 - 10	1,050		

To reduce or greatly exceed the recommended torque can adversely affect the performance of the connector.

DURIUM™ Bolt

Silicon Bronze

BURNDY® introduced silicon-bronze bolts, nuts and other hardware items on outdoor connector applications in 1927. Today the DURIUM™ trademark is a standard for this use. DURIUM™ bolts combine high strength with corrosion resistance. Heads have American Standard dimension and the threads are per American National Coarse Series, Class #2 fit. The silicon bronze is per ASTM B99.

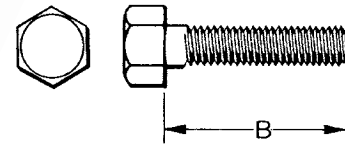

Catalog Number	Thread Size	B Length (Inches)
25X50HEBBOX	1/4-20	1/2
25X62HEBBOX	1/4-20	5/8
25X75HEBBOX	1/4-20	3/4
25X100HEBBOX	1/4-20	1
25X125HEBBOX	1/4-20	1-1/4
25X150HEBBOX	1/4-20	1-1/2
25X200HEBBOX	1/4-20	2
25X250HEBBOX	1/4-20	2-1/2
25X300HEBBOX	1/4-20	3
31X50HEBBOX	5/16-18	1/2
31X62HEBBOX	5/16-18	5/8
31X75HEBBOX	5/16-18	3/4
31X100HEBBOX	5/16-18	1
31X125HEBBOX	5/16-18	1-1/4
31X150HEBBOX	5/16-18	1-1/2
31X175HEBBOX	5/16-18	1-3/4
31X200HEBBOX	5/16-18	2
31X250HEBBOX	5/16-18	2-1/2
31X300HEBBOX	5/16-18	3
38X50HEBBOX	3/8-16	1/2
38X62HEBBOX	3/8-16	5/8
38X75HEBBOX	3/8-16	3/4
38X88HEBBOX	3/8-16	7/8
38X100HEBBOX	3/8-16	1

Catalog Number	Thread Size	B Length (Inches)
38X125HEBBOX	3/8-16	1-1/4
38X150HEBBOX	3/8-16	1-1/2
38X175HEBBOX	3/8-16	1-3/4
38X200HEBBOX	3/8-16	2
38X225HEBBOX	3/8-16	2-1/4
38X250HEBBOX	3/8-16	2-1/2
38X275HEBBOX	3/8-16	2-3/4
38X300HEBBOX	3/8-16	3
38X325HEBBOX	3/8-16	3-1/4
38X350HEBBOX	3/8-16	3-1/2
38X400HEBBOX	3/8-16	4
38X450HEBBOX	3/8-16	4-1/2
38X500HEBBOX	3/8-16	5
44X150HEBBOX	7/16-14	1-1/2
44X200HEBBOX	7/16-14	2
50X75HEBBOX	1/2-13	3/4
50X100HEBBOX	1/2-13	1
50X125HEBBOX	1/2-13	1-1/4
50X150HEBBOX	1/2-13	1-1/2
50X175HEBBOX	1/2-13	1-3/4
50X200HEBBOX	1/2-13	2
50X225HEBBOX	1/2-13	2-1/4
50X250HEBBOX	1/2-13	2-1/2
50X275HEBBOX	1/2-13	2-3/4

Catalog Number	Thread Size	B Length (Inches)
50X300HEBBOX	1/2-13	3
50X325HEBBOX	1/2-13	3-1/4
50X350HEBBOX	1/2-13	3-1/2
50X375HEBBOX	1/2-13	3-3/4
50X400HEBBOX	1/2-13	4
50X450HEBBOX	1/2-13	4-1/2
50X500HEBBOX	1/2-13	5
50X550HEBBOX	1/2-13	4-1/2
50X600HEBBOX	1/2-13	6
62X100HEBBOX	5/8-11	1
62X125HEBBOX	5/8-11	1-1/4
62X150HEBBOX	5/8-11	1-1/2
62X175HEBBOX	5/8-11	1-3/4
62X200HEBBOX	5/8-11	2
62X225HEBBOX	5/8-11	2-1/4
62X250HEBBOX	5/8-11	2-1/2
62X275HEBBOX	5/8-11	2-3/4
62X300HEBBOX	5/8-11	3
62X325HEBBOX	5/8-11	3-1/4
62X350HEBBOX	5/8-11	3-1/2
62X400HEBBOX	5/8-11	4
62X450HEBBOX	5/8-11	4-1/2
62X500HEBBOX	5/8-11	5
62X600HEBBOX	5/8-11	6

DURIUM™ Nuts

Silicon Bronze

DURIUM™ hexagon regular nuts are non-magnetic and are made to American Standard dimensions. American National Coarse Series threads. #2 fit.



Catalog Number	Thread Size
25CHENBOX	1/4-20
31CHENBOX	5/16-18
38CHENBOX	3/8-16
44CHENBOX	7/16-14
50CHENBOX	1/2-13
62CHENBOX	5/8-11
75CHENBOX	3/4-10
100CHENBOX	1-8

DURIUM™ Flat Washers

Silicon Bronze

High strength DURIUM™ Flat Washers are non-magnetic and free from galvanic action when in contact with copper. Conforms to SAE standards.

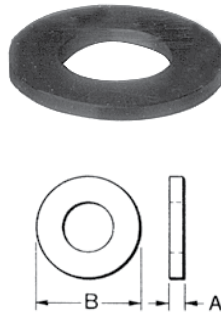

Catalog Number	For Bolt Size	Nominal Dimensions in Inches	
		A	B
25FWBOX	1/4	1/16	5/8
31FWBOX	5/16	1/16	11/16
38FWBOX	3/8	1/16	13/16
44FWBOX	7/16	1/16	15/16
50FWBOX	1/2	3/32	1-1/16
62FWBOX	5/8	3/32	1-5/16
75FWBOX	3/4	9/64	1-15/32

DURIUM™ Split Lockwashers

Silicon Bronze

DURIUM™ spring type lockwasher has high resiliency and exerts constant pressure on the face of the nut, preventing vibration from loosening the nut.



Catalog Number	For Bolt Size
25SWBOX	1/4
31SWBOX	5/16
38SWBOX	3/8
44SWBOX	7/16
50SWBOX	1/2
62SWBOX	5/8
75SWBOX	3/4

DURIUM™ Internal Lockwashers

Silicon Bronze

DURIUM™ Internal Tooth Lockwashers are available as illustrated. The teeth are twisted slightly and present biting edges which grip the nut and the part being clamped, preventing the nut from backing off.



Catalog Number	For Bolt Size
25NWBOX	1/4
31NWBOX	5/16
38NWBOX	3/8
44NWBOX	7/16
50NWBOX	1/2
62NWBOX	5/8
75NWBOX	3/4

Aluminum Bolts

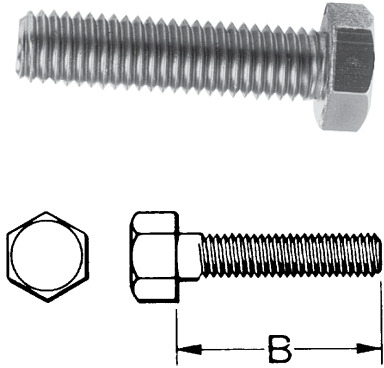

BURNDY® aluminum hexagon head bolts are manufactured of alloy 2024-T4 and are finished with anodic coating and lubricated. Threads are coarse series, class 2A fit.

Catalog Number	Thread Size	B Length (Inches)
50X150HABBOX	1/2-13	1-1/2
50X175HABBOX	1/2-13	1-3/4
50X200HABBOX	1/2-13	2
50X225HABBOX	1/2-13	2-1/4
50X250HABBOX	1/2-13	2-1/2
50X275HABBOX	1/2-13	2-3/4
50X300HABBOX	1/2-13	3
50X325HABBOX	1/2-13	3-1/4
50X350HABBOX	1/2-13	3-1/2
50X375HABBOX	1/2-13	3-3/4
50X400HABBOX	1/2-13	4
50X425HABBOX	1/2-13	4-1/4
50X450HABBOX	1/2-13	4-1/2

Catalog Number	Thread Size	B Length (Inches)
50X500HABBOX	1/2-13	5
50X550HABBOX	1/2-13	5-1/2
62X175HABBOX	5/8-11	1-3/4
62X200HABBOX	5/8-11	2
62X225HABBOX	5/8-11	2-1/4
62X250HABBOX	5/8-11	2-1/2
62X300HABBOX	5/8-11	3
62X350HABBOX	5/8-11	3-1/2
62X400HABBOX	5/8-11	4
62X450HABBOX	5/8-11	4-1/2
62X500HABBOX	5/8-11	5
62X550HABBOX	5/8-11	5-1/2
62X600HABBOX	5/8-11	6

Aluminum Nuts

BURNDY® aluminum nuts are manufactured of alloy 6061-T6, are finished type, coarse thread, class 2B fit.



Catalog Number	Thread Size
50HANBOX	1/2-13
62HANBOX	5/8-11

Aluminum Flat Washers

BURNDY® aluminum flat washers are manufactured of alloy 2024-T4 and are medium design.



Catalog Number	For Bolt Size
50FWABOX	1/2
62FWABOX	5/8

Aluminum Split Lockwashers

BURNDY® aluminum split lockwashers are manufactured of alloy 7075-T6 and are regular design.



Catalog Number	For Bolt Size
50SWALBOX	1/2
62SWALBOX	5/8

Galvanized Steel Hardware

Galvanized bolts, nuts, flatwashers, and internal tooth lockwashers are manufactured per ASTM307 Grade A. Nut surfaces and bolt heads have American Standard dimensions, and the threads are per American National Coarse Series, Class #2 fit. Galvanizing is per ASTM A153.

Bolts



Catalog Number	Thread Size	Length (B)
38X125HGSBBOX	3/8-16	1.25
38X275HGSBBOX	3/8-16	2.75
38X225HGSBBOX	3/8-16	2.25
50X100HGSBBOX	1/2-13	1.00
50X150HGSBBOX	1/2-13	1.50
50X200HGSBBOX	1/2-13	2.00
62X100HGSBBOX	5/8-11	1.00

Catalog Number	Thread Size	Length (B)
62X175HGSBBOX	5/8-11	1.75
75X125HGSBBOX	3/4-11	1.25
75X200HGSBBOX	3/4-10	2.00
75X500HGSBBOX	3/4-10	5.00
75X600HGSBBOX	3/4-10	6.00
100X200HGSBBOX	1-8	2.00

Nuts



Catalog Number	Thread Size
31CHGSNBOX	5/16-18
38HGSN009BOX	3/8-16
38HGSNBOX	3/8-16
50HGSNBOX	1/2-13

Catalog Number	Thread Size
62HGSNBOX	5/8-11
75HGSNBOX	3/4-10

Flat Washers



Catalog Number	For Bolt Size	Nominal Dimensions (Inches)	
		I.D.	O.D.
38X81FWGSBOX	3/8	0.41	0.81
50X106FWGSBOX	1/2	0.53	1.06
62X131FWGSBOX	5/8	0.66	1.31

Internal Tooth Lockwashers



Catalog Number	Bolt Size
38NWGSBOX	3/8
50NWGSBOX	1/2
62NWGSBOX	5/8
75NWGSBOX	3/4

Stainless Steel Hardware

Stainless steel bolts, nuts, flatwashers and split lockwashers are manufactured from 18-8 non-magnetic material. Nut surfaces and bolt heads have American National Coarse Series, Class #2 fit.

Bolts

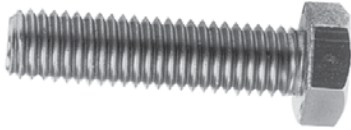

Catalog Number	Thread Size	Length
38X125HSSBBOX	3/8-16	1-1/4
38X225HSSBBOX	3/8-16	2-1/4
38X250HSSBBOX	3/8-16	2-1/2
38X275HSSBBOX	3/8-16	2-3/4
50X200HSSBBOX	1/2-13	2

Catalog Number	Thread Size	Length
50X250HSSBBOX	1/2-13	2-1/2
50X300HSSBBOX	1/2-13	3
62X300HSSBBOX	5/8-11	3
75X300HSSBBOX	3/4-10	3

Nuts



Catalog Number	Thread Size
25HSSNBOX	1/4-20
38HSSNBOX	3/8-16
50HSSNBOX	1/2-13
62HSSNBOX	5/8-11
75HSSNBOX	3/4-10

Split Lockwashers



Catalog Number	For Bolt Size
25SWSSLTBOX	1/4
38SWSSMDBOX	3/8
50SWSSMDBOX	1/2
62SWSSMDBOX	5/8

Flat Washers



Catalog Number	For Bolt Size	Nominal Dimensions (Inches)	
		I.D.	O.D.
25FWSBOX	1/4	0.27	0.69
38FWSBOX	3/8	0.41	1.00
50FWSBOX	1/2	0.59	1.13
62FWSBOX	5/8	0.66	1.31

Stainless Steel Belleville Washers

Any bolted "pad to flat" electrical connection should include a bolt, two flatwashers, and the nut. In addition, if any of the flat components is aluminum, a properly designed Belleville washer should be interposed between one of the flatwashers and either the bolt head or the nut, with the hollow of the Belleville washer placed against the flat washer. BURNDY® Belleville washers are designed to maintain substantial force when tightened to NEMA-recommended values and finely finished to avoid galling.

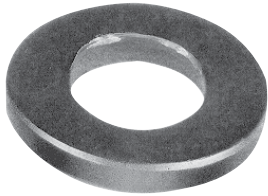

Catalog Number	Bolt Size	Nominal Dimensions		
		Thickness	I.D.	O.D.
38X75BWSSBOX	3/8	0.06	0.39	0.75
50X106BWSSBOX	1/2	0.10	0.53	1.06



Recommended Termination Hardware

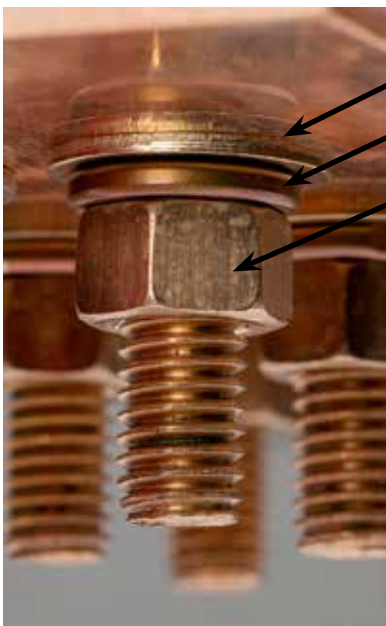

- Bolt
- Flat Washer
- Terminal
- Surface (Busbar here)
- Flat Washer
- Lockwasher
- Nut

Type TMH DURIUM™ Silicon Bronze Hardware Kits

Type TMH DURIUM™ silicon bronze hardware kits can be ordered for specific applications ensuring the proper type and amount of hardware for each installation. Packaged in separate sealed bags, they are convenient to use, eliminating mismatched quantities. DURIUM™ silicon bronze material provides long lasting corrosion resistance Grade 2.



Catalog Number	Size	Each TMH Kit Includes:					Working Range (R)	Installation Torque (In-lbs)
		Bolt		Flat Washer	Split Washer	Hex Nut		
		Length	Qty					
TMH262	1/4-20	0.75	2	4	2	2	0.09 - 0.34	80
TMH263		1.00	2	4	2	2	0.34 - 0.59	
TMH264		1.25	2	4	2	2	0.59 - 0.84	
TMH265		1.50	2	4	2	2	0.84 - 1.09	
TMH266	3/8-16	0.75	2	4	2	2	0.00 - 0.19	240
TMH267		1.00	2	4	2	2	0.19 - 0.44	
TMH268		1.25	2	4	2	2	0.44 - 0.69	
TMH269		1.50	2	4	2	2	0.69 - 0.94	
TMH270		1.75	2	4	2	2	0.94 - 1.19	
TMH271		2.00	2	4	2	2	1.19 - 1.44	
TMH332 ②		2.75	2	4	2	2	-	
TMH261 †		3.00	2	4	2	2	2.15 - 2.40	
TMH289 ††	1.25	1	2	1	1	0.02 - 0.27	480	
TMH295	1.25	2	4	2	2	0.27 - 0.49		
TMH272	1.50	2	4	2	2	0.49 - 0.74		
TMH294	1.75	2	4	2	2	0.74 - 0.99		
TMH69	2.00	2	4	2	2	0.99 - 1.24		

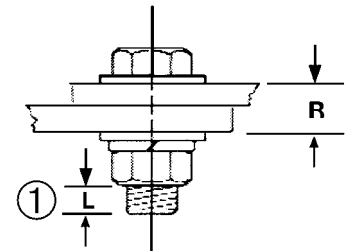

† For use with CUSA750-2TC38 copper spacer adaptor, (2) terminals and * thick equipment bus bar. For other combinations contact BURNDY®.
 †† For use with all GAR-TC connectors. "R" dimension is allowable pad thickness of terminal

* For other combinations contact BURNDY®.
 ① "L" dimension never exceeds 0.25"
 ② For use with CUSA442TC38 on 1/4" bus bar and HYLUG™ 4/0 - 750 kcmil.

Type TMH-SS Stainless Steel Hardware Kits

Type TMH-SS are stainless steel hardware kits. Just like the standard TMH kits, these kits can be ordered for specific applications ensuring the proper type and amount of hardware for each installation. They are packaged in separate sealed bags and convenient for use and ordering.

Catalog Number	Size	Each TMH Kit Includes:					Working Range (R)	Installation Torque (In-lbs)
		Bolt		Flat Washer	Split Washer	Hex Nut		
		Length	Qty					
TMH322SS	10-32	0.88	1	0	1	1	-	45
TMH262SS	1/4-20	0.75	2	4	2	2	0.09 - 0.34	80
TMH263SS		1.00	2	4	2	2	0.34 - 0.59	
TMH264SS		1.25	2	4	2	2	0.59 - 0.84	
TMH265SS		1.50	2	4	2	2	0.84 - 1.09	
TMH267SS	3/8-16	1.00	2	4	2	2	0.19 - 0.44	240
TMH268SS		1.25	2	4	2	2	0.44 - 0.69	
TMH269SS		1.50	2	4	2	2	0.69 - 0.94	
TMH270SS		1.75	2	4	2	2	0.94 - 1.19	
TMH271SS		2.00	2	4	2	2	1.19 - 1.44	
TMH261SS †	3.00	2	4	2	2	2.15 - 2.40	480	
TMH295SS	1.25	2	4	2	2	0.27 - 0.49		
TMH272SS	1.50	2	4	2	2	0.49 - 0.74		
TMH294SS	1.75	2	4	2	2	0.74 - 0.99		
TMH69SS	2.00	2	4	2	2	0.99 - 1.24		

Type COVERYA Covers for Transformer Connectors

These plastisol covers are typically used to cover secondary connections inside a 3-Phase pad mounted transformer and are provided in 9-1/2", 12", or 14" lengths to accommodate larger Paddle installations commonly found in Wind, Solar, and Utility applications. The covers are offered in orange or black as standard, but are available in a variety of colors. Multipurposed for use in many different applications covering mechanical and compression connectors. Covers are manufactured of dielectric grade PVC.

Contact the factory for any additional designs or colors that may be necessary for your specific application.



Features & Benefits

- Offered in orange or black as standard, but available in a variety of colors
- Multipurposed for use in many different applications covering mechanical and compression connections
- Labor Saving design features opening on the back end (T-Slit) to fit over Transformer Support Brackets without need for any dangerous "in-field" cutting or manipulation
- .88" diameter hole on the back allows for ground stud to fit through easily
- Hot Stick Adapter on top allows for safer removal when necessary
- Covers are manufactured in Black or Orange dielectric grade PVC

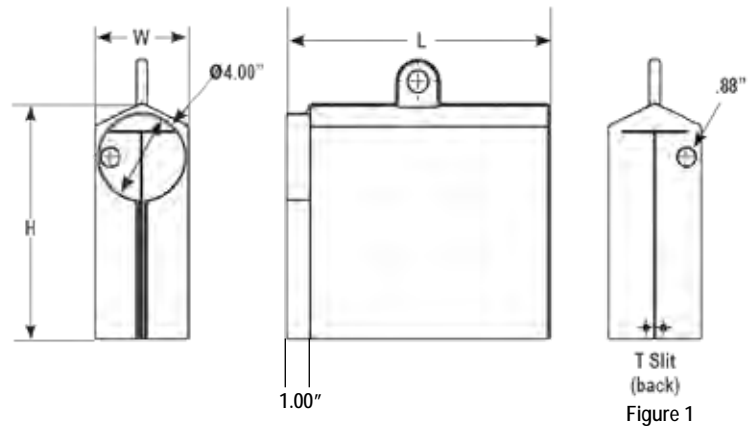

Catalog Number	Color	Figure	Slit Design	Dimensions		
				L	W	H
COVERYA3ORG	Orange	1	T-Slit Back	9.50	4.25	10.75
COVERYA3BLK	Black					
COVERYA4ORG	Orange	1	T-Slit Back	12.00	4.25	10.75
COVERYA4BLK	Black					
COVERYA5ORG	Orange	2	Side Slit	12.50	4.25	10.75
COVERYA5BLK	Black					
COVERYA6ORG	Orange	1	T-Slit Back	14.00	6.25	10.75
COVERYA6BLK	Black					

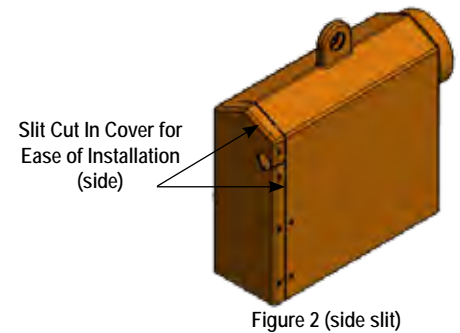

*Contact customer service or your local sales representative for additional colors or sizes not listed.

WIREMIKE™

Stainless Steel Wire Micrometer

Features and Benefits

- Strong, durable, high quality
- Allow for use as both caliper and ruler
- Most formats measures I.D. and O.D. of tubing, thin-wall and rigid conduit including IPS, ACSR, stranded and solid commercial cables

Catalog # WIREMIKE, WIREMIKED and RK1942 are for use on:

ACSR

#6 to 336.4 (26/7) Stranded

Stranded AWG

#18 to 2000 kcmil

Solid

#20 to 4/0 AWG

IPS Tubing (Cu/Al) and Rigid Conduit:

1/4" to 2-1/2"

Tubing Sizes:

3-1/8" inside maximum; 2-15/16" outside maximum

Thin-wall Conduit:

3/8" to 2-1/2"

Catalog # WIREMIKECI is for use on:

Compression Connectors and Splices (including Compression Grounding)

#18 to 2500 kcmil Copper Class B

#10 to 4/0 Solid Aluminum / Copper

#18 to 3500 kcmil Concentric Aluminum

#8 to 1100 kcmil Compact Aluminum

#14 to 1111 kcmil Copper DLO

Also used for reference only* for inspection of completed crimp when using Butting Copper or Aluminum Dies with the 750, 46, 35, or 39 series of tools.

Copper Dies U8CRT to U44XRT

Aluminum Dies U8CABT to U39ART2



WIREMIKE

Variations:

- WIREMIKE** Stainless Steel with inch/fraction markings
- WIREMIKECI** Stainless Steel, no ruler capabilities but may be used for reference on specific completed crimps (see more detail below on WIREMIKECI)
- WIREMIKED** Stainless Steel, decimal markings in place of fraction markings, same capabilities as catalog # WIREMIKE™
- RK1942** Convenience packaging of WIREMIKE (with inch markings) in packaging suitable for hanging on a rack; sold in multiples of 10 only

Catalog # WIREMIKECI is for use on:

Compression Connectors and Splices (including Compression Grounding)

#18 to 2500 kcmil Copper Class B

#10 to 4/0 Solid Aluminum / Copper

#18 to 3500 kcmil Concentric Aluminum

#8 to 1100 kcmil Compact Aluminum

#14 to 1111 kcmil Copper DLO

Also used for reference only* for inspection of completed crimp when using Butting Copper or Aluminum Dies with the 750, 46, 35, or 39 series of tools.

Copper Dies U8CRT to U44XRT

Aluminum Dies U8CABT to U39ART2

Close up for the Die Inspection Section (Used for Reference Only*) Catalog # WIREMIKECI only



*WIREMIKECI tool is to provide measurements for reference only, not to confirm the suitability of connection. Customer is responsible to independently verify suitability of connection.

Table of Contents

Available Materials.....	G-2	WILEY Bundle Straps.....	G-25
Material Specifications.....	G-2	WILEY Coated P-Clips.....	G-26
Material Performance Guide.....	G-3	WILEY Cable Hangers.....	G-26
Cable Tie Catalog Schema.....	G-3	WILEY Cable Clips.....	G-27
Military Specification Information for UNIRAP™ Cable Ties.....	G-4	WILEY Edge Clip with Cable Tie.....	G-29
UNIRAP™ Nylon Cable Ties - Engineering and Performance.....	G-5	Cable Tie Tools.....	G-30
UNIRAP™ Standard Nylon 6/6 Cable Ties.....	G-6	145PTAG 94V0 Rated Nylon Tag.....	G-30
UNIRAP™ Nylon 6/6 Identification Cable Ties.....	G-10		
UNIRAP™ Nylon 6/6 Push Mount Cable Ties.....	G-10		
Fir Tree Cable Tie Nylon 6/6.....	G-10		
UNIRAP™ Nylon 6/6 Releasable Cable Ties.....	G-11		
UNIRAP™ Nylon 6/6 Metal Detectable Cable Ties.....	G-11		
UNIRAP™ Nylon 6/6 Mounting Hole Cable Ties.....	G-12		
UNIRAP™ Heat Stabilized 6/6 Nylon Cable Ties.....	G-12		
UNIRAP™ Nylon 6/6 Standard Cable Tie Mounting Bases.....	G-13		
UNIRAP™ Nylon 6/6 Cable Hangers.....	G-14		
UNIRAP™ Stainless Steel Barb Cable Ties.....	G-15		
UNIRAP™ Nylon 6/6 Universal Grade Cable Ties.....	G-17		
UNIRAP™ Nylon 6/6 Mounting Hole Universal Grade Cable Ties.....	G-19		
UNIRAP™ Nylon 6/6 Universal Grade Mounting Bases.....	G-19		
UNIRAP™ Nylon 6/6 Cable Tie Variety Canister.....	G-20		
UNIRAP™ Nylon 12 Cable Ties.....	G-20		
VELCRO® Hook and Loop Straps.....	G-21		
TEFZEL® Fluoropolymer Ties.....	G-21		
UNIRAP™ Stainless Steel Ties; Grade 304; Uncoated.....	G-22		
UNIRAP™ Stainless Steel Ties; Grade 304; Partially Coated.....	G-23		
UNIRAP™ Stainless Steel Ties; Grade 304; Fully Coated.....	G-24		

Most frequently ordered catalog numbers are highlighted in BLUE

Available Materials

Nylon 6/6 — General Purpose

General purpose nylon 6/6 features light weight, high strength and a wide temperature range. It is halogen free so it does not release dangerous gases, such as chlorine, bromine, fluorine and iodine when burned. Nylon 6/6 is hydroscopic, and therefore, absorbs or releases moisture depending on its environment. Thus, the moisture level of the material will affect tensile strength, stiffness and elongation of the product.

Nylon 6/6 — Heat Stabilized

With similar properties and benefits as nylon 6/6, products manufactured with heat stabilized nylon 6/6 material have a chemical stabilizer added for higher continuous temperature applications.

Nylon 6/6 — UV Stabilized

Chemical inhibitors are used to give nylon 6/6 material added properties to fight against premature aging of products due to the effects of ultraviolet rays.

Nylon 6/6 — UV Stabilized (2% Carbon for Military Specification)

The physical properties of this material include carbon, which acts as a UV stabilizer, prolonging the life of the product under ultraviolet conditions. It also allows cable ties to meet the particular military specification for cable ties.

Nylon 6/6 — V0 Flame Retardant

This material meets UL 94V-0 flammability requirements. Flame retardant additives generally reduce tensile strength when compared to general-purpose nylon 6/6, but this resin has been formulated to minimize such effects.

Nylon 6/6 — Metal Detectable

Metal content blended through cable tie. Meets US FDA food contact material compliance. Used to help prevent possible contamination that may result in recalls. Often used in food processing, beverage, pharmaceutical and cosmetic industries.

Nylon 6/6 — High Impact

Impact modifiers are added to increase flexibility. High impact nylon 6/6 has stable tensile strength due to its reduced influence from moisture. It is excellent for high vibration applications, as within the aircraft and automobile industries and performs better than nylon 6/6 against ultraviolet rays. Good for outdoor use.

Polypropylene

Polypropylene is used in environments where chemical effects on nylon are a concern. It is not affected by inorganic acids (hydrochloric), polyhydric alcohols (ethyleneglycol), neutral salts (sodium chloride) and basic salts (sodium bicarbonate). Polypropylene also resists a number of other chemicals with good results, although it has lower tensile strength than nylon 6/6 (about half). Polypropylene has good UV resistance.

Nylon 12 — UV Stabilized

Nylon 12 is resistant to chemicals and salts. Ideal for solar applications. Weather resistant grade, produced by the addition of stabilizers to the nylon resin.

Stainless Steel

Stainless Steel is used where corrosion, vibration, weathering, and temperature extremes are a concern. May be used for virtually any indoor, outdoor, or underground application. Available in both 304 and 316 Stainless Steel. Also available partially or fully coated with polyester.

TEFZEL® Fluoropolymer

TEFZEL® Fluoropolymer ties feature a low smoke density with excellent flammability rating (UL 94V-0) and tolerates extreme high and low temperatures. TEFZEL® comes in an aqua blue color with an operating temperature of Min. -112°F (-80°C), Max. 338°F (170°C). TEFZEL® is a Registered trademark of E. I. du Pont de Nemours and Company.

Material Specifications

Material	Continuous* Operating Temperature Max. Min.	Tensile Strength at 73° F Dry as Molded ASTM D-638 (PSI)	UL Flame Rating	Oxygen Index %	Gamma Radiation Resistance	UV Resistance	Military, Federal, ASTM, and FDA Specifications
Nylon 6/6 — General Purpose (CT)	185° F —40° F 85° C —40° C	12,000	94V-2	28	1 x 10 ⁵ Rads	Poor	ASTM D-4066PA0111 FDA CFR177.1500
Nylon 6/6 — Heat Stabilized (CTHS)	220° F —40° F 105° C —40° C	12,000	94V-2	26	1 x 10 ⁵ Rads	Poor	ASTM D-4066PA0121
Nylon 6/6 — UV Stabilized (O)	185° F —40° F 85° C —40° C	12,000	94V-2	26	1 x 10 ⁵ Rads	Good	ASTM D4066PA0191
Nylon 6/6 — 2% Carbon UV Stabilized (OO)	220° F —40° F 105° C —40° C	12,000	94V-2	26	1 x 10 ⁵ Rads	Good	ASTM D-4066PA0181 MS3367/8
Nylon 6/6 — Flame Retardant (CTV)	185° F —40° F 85° C —40° C	10,800	94V-0	34	1 x 10 ⁵ Rads	Poor	ASTM D-4066PA0110
Nylon 6/6 — High Impact	185° F —40° F 85° C —40° C	8,800	94-HB	19	1 x 10 ⁵ Rads	Good	ASTM D-4066PA0150
Polypropylene — Chemical Resistant (CTPP)	185° F —40° F 85° C —40° C	3,400	94-HB	N/A	1 x 10 ⁵ Rads	Good	ASTM D-4101PP0320 FDA CFR177.1520
Nylon 12 — UV Stabilized	176° F —40° F 80° C —40° C	5,800	94-HB	N/A	9 x 10 ⁶ Rads	Good	ASTM D-4066PA411

* Elevated temperatures, over time, will affect materials' properties such as tensile strength, stiffness, elongation and appearance.

BURNDY® recommends the evaluation of cable ties in the actual application to determine the suitability of the tie for that application.

Material Performance Guide

Selection	Nylon 6/6 General Purpose	Nylon 6/6 Heat Stab.	Nylon 6/6 UV Stab.	Nylon 6/6 2% Carbon UV Stab.	Nylon 6/6 Flame Ret. V0	Nylon 6/6 High Impact	Poly- propylene	Nylon 12 UV Stab.
Tensile Strength	8	8	8	9	7	8	2	4
High Temp.	2	3	2	2	2	2	2	1
Flammability	5	5	5	5	10	2	2	2
UV Resistance	1	1	5	8	1	2	5	3
Radiation	3	3	3	3	3	3	6	3
Chemical	6	6	6	6	6	6	8	8
— Hydrocarbons	8	8	8	8	8	8	6	8
— Chlorinated	6	6	6	6	6	6	3	8
— Hydrocarbons	2	2	2	2	2	2	8	5
— Acids-Bases	6	6	6	6	6	6	8	6
— Salts	3	3	3	3	3	3	10	8
Relative Cost	Low	Low	Med.	Med.	Med.	Med.	Med.	Med.

1 = Least Recommended 10 = Most Recommended

The following chart is meant to help you understand BURNDY's cable tie catalog numbering system. Not every cable tie is available in every listed option. See below Catalog Numbering System Charts or contact BURNDY® Customer Service for more information.

Gray bars contain catalog number examples.

Type	Tensile	Bundle Dia.	Feature	Package	Color
CT	50	175		C	
CT = Nylon 6/6 Standard	18 = 18 lbs. 30 = 30 lbs. 40 = 40 lbs.	075 = 3/4" 087 = 7/8" 100 = 1"	CPM = Center Push Mount DL = Double Loop EPR = Extended Pawl Releasable	V = 5 X = 10 O = 25	0 = UV Black ¹ 00 = UV Black ² 02 = Red
CTAS = Aerial Support	50 = 50 lbs. 100 = 100 lbs. 110 = 110 lbs.	125 = 1-1/4" 137 = 1-3/8" 150 = 1-1/2"	ID = Single Head ID ID2 = Double Head ID ID3 = Triple Head ID	L = 50 C = 100 B = 250 D = 500 M = 1000	1 = Brown 2 = Red 3 = Orange 4 = Yellow 5 = Green 6 = Blue 7 = Purple 8 = Gray 9 = Neon Green 10 = White 11 = Telco Gray 12 = Pink 20 = Black
CTHS = Nylon 6/6 Heat Stabilized	120 = 120 lbs. 175 = 175 lbs. 225 = 225 lbs.	175 = 1-3/4" 200 = 2" 225 = 2-1/4"	FL = ID Flag MH4 = Mounting Hole #4 MH6 = Mounting Hole #6 MH8 = Mounting Hole #8 MH10 = Mounting Hole #10 MH14 = Mounting Hole #14		
CTV = Nylon 6/6 Flame Retardant UL94V-0	250 = 250 lbs. 450 = 450 lbs. 500 = 500 lbs.	250 = 2-1/2" 300 = 3" 325 = 3-1/4"	PM = Push Mount Tie PML = Push Mount Tie w/Louvers PMW = Push Mount Tie w/Wing		
CTPP = Polypropylene	675 = 675 lbs. 700 - 700 lbs. 800 = 800 lbs.	350 = 3-1/2" 400 = 4" 425 = 4-1/4"	R = Releasable Tie LD = Ladder LP = Low Profile Tie PS = Positive Stop SSB = Stainless Steel Barb		
CTSS = Stainless Steel	900 = 900 lbs.	500 = 5" 600 = 6" 700 = 7" 750 = 7-1/2" 800 = 8" 900 = 9" 1000 = 10" 1100 = 11" 1200 = 12" 1300 = 13" 1400 = 14"	FC304 = Fully Coated 304 FC316 = Fully Coated 316 PC304 = Partially Coated 304 PC316 = Partially Coated 316 SSH = Stainless Steel Hook		Blank = Natural

¹Material: Nylon 6/6 — UV Stabilized

²Material: Nylon 6/6 — 2% Carbon UV Stabilized (Mil. Spec.)

Type	Bundle Diameter	Adhesive/Mounting Type	Figure #	Package	Color
CTB	100	RA		C	0
CTB = Cable Tie Base	075 = 3/4"	RA = Rubber Adhesive	#1	L = 50	0 = UV Black
CTBR = Cable Tie Base Rectangular	125 = 1-1/4" 150 = 1-1/2"	AA = Acrylic Adhesive S = Screw Mounted	#2 #3	C = 100 D = 500 M = 1000	Blank = Natural
CTBRWR = Cable Tie Base Weather Resistant					

Military Specification Information on UNIRAP™ Cable Ties

The BURNDY® UNIRAP™ Cable Ties shown below meet the requirements of SAE AS23190A (formerly MIL-S-23190) in accordance with specification MS3367, MS3368, and QPL-23190.

Mil Spec	Distributor Pack Catalog Number	Bulk Pack Catalog Number	Color
MS3367-1-0	CT50175C00	CT50175M00	UV Black ²
MS3367-1-0	CT50175C0	CT50175M0	UV Black ¹
MS3367-1-1	CT50175C1	—	Brown
MS3367-1-2	CT50175C2	CT50175M02	Red
MS3367-1-3	CT50175C3	—	Orange
MS3367-1-4	CT50175C4	—	Yellow
MS3367-1-5	CT50175C5	—	Green
MS3367-1-6	CT50175C6	—	Blue
MS3367-1-7	CT50175C7	—	Purple
MS3367-1-8	CT50175C8	—	Gray
MS3367-1-9	CT50175C	CT50175M	Natural
MS3367-2-0	CT50400C00	CT50400M00	UV Black ²
MS3367-2-0	CT50400C0	CT50400M0	UV Black ¹
MS3367-2-2	CT50400C2	CT50400M02	Red
MS3367-2-3	CT50400C3	—	Orange
MS3367-2-9	CT50400C	CT50400M	Natural
MS3367-3-0	CT120400L00	CT120400D00	UV Black ²
MS3367-3-0	CT120400L0	CT120400D0 CT120400M0	UV Black ¹
MS3367-3-9	CT120400L	CT120400D	Natural
MS3367-4-0	CT18075C00	CT18075M00	UV Black ²
MS3367-4-0	CT18075C0	CT18075M0	UV Black ¹
MS3367-4-9	CT18075C	CT18075M	Natural
MS3367-5-0	CT30125C00	CT30125M00	UV Black ²
MS3367-5-0	CT30125C0	CT30125M0	UV Black ¹
MS3367-5-9	CT30125C	CT30125M	Natural
MS3367-7-0	CT50300C00	CT50300M00	UV Black ²
MS3367-7-0	CT50300C0	CT50300M0	UV Black ¹
MS3367-7-2	CT50300C2	—	Red
MS3367-7-9	CT50300C	CT50300M	Natural
MS3367-10-0	CT175600Q0	—	UV Black ¹
MS3367-10-9	CT175600Q	—	Natural
MS3367-13-0	CT175900Q00	—	UV Black ²
MS3367-13-0	CT1751100Q0	—	UV Black ¹
MS3367-13-9	CT1751100Q	—	Natural

¹Material: Nylon 6/6 UV Stabilized

²Material: Nylon 6/6 2% UV Stabilized - Mil. Spec.

UNIRAP™ Nylon Cable Ties

UNIRAP™ cable ties are fabricated of one piece Nylon with no metal parts. The straps are tough, resilient, lightweight and abrasion resistant. They offer high tensile strength and are chemically resistive to solvents, alkalies, oils, grease and diluted acids. Self-locking, they secure without twisting or leaving sharp projections.

Compact heads and pre-bent tips facilitate cable bundling in a minimum of time and space. UNIRAP™ cable ties are designed for both field and production line use and may be installed easily by hand.



BURNDY® cable ties consist of three components: strap, head, and tail. These components are specifically designed to function together to make BURNDY® UNIRAP™ cable ties superior in quality and performance. Shelf life of 5 years, when stored in original packaging.

Component

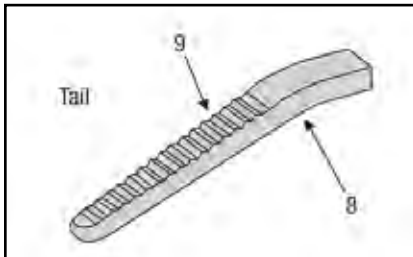
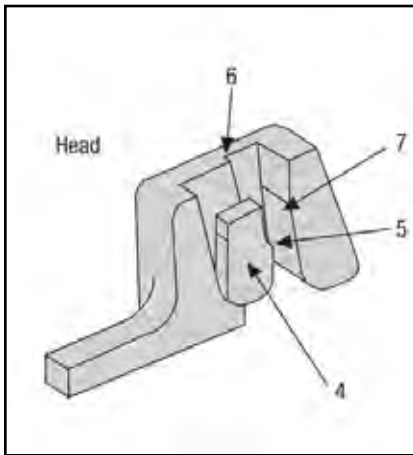
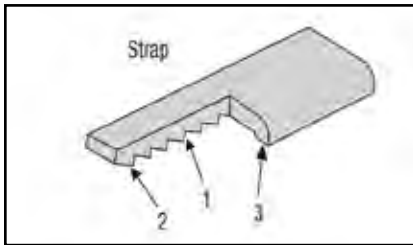

Precision Engineering

1. Includes load bearing serrations.
2. Features **flats** between the serrations.
3. Features the double outer rail system.
4. The pawl is integrally formed with the head.
5. The pawl is stepped in order to wedge against the serrations in the strap to form the lock.
6. The shoulders, or the sides of the head, guide the strap and prevent it from disengaging from the pawl during loaded conditions.
7. The back supports the strap during the wedging of the lock formation.

Enhanced Performance

1. Serrations provide complete adjustability within the fastening range.
2. Flats reduce stress concentrations and help make the tie stronger.
3. Smooth rails promote low drag, as well as minimize chafing.
4. The locking unit will not disengage. It also promotes low insertion with high pull out force for very easy installation.
5. The tie's ultimate strength achieves optimum levels.
6. Promotes cable tie strength, endurance and longevity.
7. Ensure optimum locking capability.
8. Easy pick-up for installers, which leads to fast assembly.
9. Allows for easy, no-slip grip.

UNIRAP™ Standard Cable Ties Type CT

General purpose nylon 6/6 features light weight, high strength and a wide temperature range. It is halogen free so it does not release dangerous gases, such as chlorine, bromine, fluorine, or iodine when burned. Nylon 6/6 is hydroscopic, and therefore absorbs or releases moisture depending on its environment. Thus, the moisture level of the material will affect tensile strength, stiffness, and elongation of the product.



UV Black / UV Black (Mil. Spec.) are 2% Carbon UV Stabilized.



UL62275
Type 2 & 21

Std Pkg Catalog Number	Color	Max. Bundle Dia. In. [mm]	Min. Tensile Strength (lb)	Length		Width		Bulk Pkg Catalog Number	UL Type	Plenum Rated
				in	[mm]	in	[mm]			
Nylon UNIRAP - 18 Lb. Tensile Strength										
CT18075C	Natural (Mil. Spec.)	0.75 [19.1]	18	4.10 [104]	0.10 [2.5]	-	-	CT18075M	UL 62275, Type 2 & 21	Y
CT18075C0	UV Black (Mil. Spec.)							CT18075M0		
CT18075C00	UV Black (Mil. Spec.)							CT18075M00		
CT18125C	Natural	1.25 [31.8]	18	6.10 [155]	0.10 [2.5]	-	-	CT18125M	UL 62275, Type 2 & 21	Y
CT18125C0	UV Black							CT18125M0		
CT18125C3	Orange							-		
CT18125C4	Yellow							-		
CT18200C	Natural	2.00 [50.8]	18	8.10 [206]	0.10 [2.5]	-	-	CT18200M	UL 62275, Type 2 & 21	Y
CT18200C1	Brown							-		
CT18200C2	Red							-		
CT18200C5	Green							-		
CT18200C6	Blue							-		
CT18200C0	UV Black							CT18200M0		
Nylon UNIRAP - 30 Lb. Tensile Strength										
CT30125C	Natural (Mil. Spec.)	1.25 [31.8]	30	5.75 [146]	0.14 [3.6]	-	-	CT30125M	UL 62275, Type 2 & 21	Y
CT18125C3	Orange							-		
CT18125C4	Yellow							-		
CT30125C0	UV Black (Mil. Spec.)							CT30125M0		
CT30125C00	UV Black (Mil. Spec.)							CT30125M00		

UNIRAP™ Standard Cable Ties Type CT
(Continued)



Std Pkg Catalog Number	Color	Max. Bundle Dia. In. [mm]	Min. Tensile Strength (lb)	Length		Width		Bulk Pkg Catalog Number	UL Type	Plenum Rated
				in [mm]	in [mm]	in [mm]	in [mm]			
Nylon UNIRAP - 40 Lb. Tensile Strength										
CT40200C	Natural	2.00 [50.8]	40	8.65 [220]	0.14 [3.6]	CT40200M		UL 62275, Type 2 & 21	Y	
CT40200C0	UV Black					CT40200M0				
CT40200C00	UV Black					CT40200M00				
CT40300C	Natural	3.00 [76.2]		11.10 [282]	0.18 [4.6]	CT40300M				
CT40300C0	UV Black					CT40300M0				
CT40300C00	UV Black					CT40300M00				
CT40400C	Natural	4.00 [101.6]		14.60 [371]	0.18 [4.6]	CT40400M				
CT40400C0	UV Black					CT40400M0				
CT40400C00	UV Black					CT40400M00				
Nylon UNIRAP - 50 Lb. Tensile Strength										
CT50175C	Natural (Mil. Spec.)	1.75 [44.5]	50	7.60 [193]	0.18 [4.6]	CT50175M		UL 62275, Type 2 & 21	Y	
CT50175C0	UV Black (Mil. Spec.)					CT50175M0				
CT50175C1	Brown (Mil. Spec.)					CT50175M02				
CT50175C2	Red (Mil. Spec.)					-				
CT50175C3	Orange (Mil. Spec.)					-				
CT50175C4	Yellow (Mil. Spec.)					-				
CT50175C5	Green (Mil. Spec.)					-				
CT50175C6	Blue (Mil. Spec.)					-				
CT50175C7	Purple (Mil. Spec.)					-				
CT50175C8	Gray (Mil. Spec.)					-				
CT50175C00	UV Black (Mil. Spec.)					CT50175M00				

UNIRAP™ Standard Cable Ties Type CT (Continued)



UL62275
Type 2 & 21



UR1565



Std Pkg Catalog Number	Color	Max. Bundle Dia. In. [mm]	Min. Tensile Strength (lb)	Length		Width		Bulk Pkg Catalog Number	UL Type	Plenum Rated
				in [mm]	in [mm]	in [mm]	in [mm]			
CT50300C	Natural (Mil. Spec.)	3.00 [76.2]	50	11.10 [282]	0.18 [4.6]	CT50300M	UL 62275, Type 2 & 21	CT50300M	Y	
CT50300C0	UV Black (Mil. Spec.)									CT50300M0
CT50300C2	Red (Mil. Spec.)									-
CT50300C00	UV Black (Mil. Spec.)									CT50300M00
CT50400C	Natural (Mil. Spec.)	4.00 [101.6]	50	14.60 [371]	0.18 [4.6]	CT50400M	UL 62275, Type 2 & 21	CT50400M	Y	
CT50400C0	UV Black (Mil. Spec.)									CT50400M0
CT50400C2	Red (Mil. Spec.)									CT50400M02
CT50400C3	Orange (Mil. Spec.)									-
CT50400C00	UV Black (Mil. Spec.)									CT50400M00

Nylon UNIRAP - 120 Lb. Tensile Strength

CT120200L	Natural	2.00 [50.8]	120	9.00 [229]	0.30 [7.6]	CT120200D	UL 62275, Type 2 & 21	CT120200D	Y	
CT120200L0	UV Black (Mil. Spec.)									CT120200D0
CT120400L	Natural (Mil. Spec.)	4.00 [101.6]	120	15.00 [381]	0.30 [7.6]	CT120400D	UL 62275, Type 2 & 21	CT120400D	Y	
CT120400L0	UV Black (Mil. Spec.)									CT120400D0 CT120400M0
CT120400L00	UV Black (Mil. Spec.)									CT120400D00
CT120800L	Natural	8.00 [203.2]	120	28.51 [724]	0.30 [7.6]	—	UL 62275, Type 2 & 21	—	N	
CT120800L00	UV Black									—

UNIRAP™ Standard Cable Ties Type CT (Continued)



UL62275
Type 2 & 21



UR1565

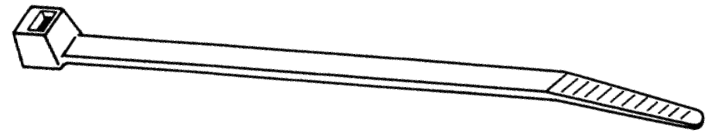

Std Pkg Catalog Number	Color	Max. Bundle Dia. In. [mm]	Min. Tensile Strength (lb)	Length	Width	Installation Tooling		Bulk Pkg Catalog Number	UL Type	Plenum Rated		
				in [mm]	in [mm]	Tool	Tool Setting (if applicable)					
Nylon UNIRAP - 175 Lb. Tensile Strength												
CT175500Q	Natural	5.50 [139.7]	175	18.10 [460]	0.34 [8.6]	MK9	Heavy	—	UL 62275, Type 2 & 21	Y		
CT175500Q0	UV Black										—	
CT175600Q	Natural (Mil. Spec.)	7.00 [177.8]		24.51 [622]	0.35 [8.9]			—			N	
CT175600Q0	UV Black (Mil. Spec.)							—				
CT175800Q0	UV Black	8.90 [222.1]		32.67 [830]	0.35 [8.9]			—		Y		
CT175900Q	Natural	8.75 [222.0]		36.50 [927]	0.34 [8.6]			—				
CT175900Q00	UV Black (Mil. Spec.)							—				
CT1751100Q	Natural (Mil. Spec.)	11.00 [279.4]						48.00 [1219]		0.35 [8.9]	—	N
CT1751100Q0	UV Black (Mil. Spec.)										—	
CT1751400Q0	UV Black	15.00 [381.0]		48.50 [1232]	0.34 [8.6]			—		UR 1565		
CT1751500Q	Natural		—			UL 62275, Type 2 & 21						
Nylon UNIRAP - 250 Lb. Tensile Strength												
CT250600Q	Natural	6.00 [152.4]	250	23.00 [584]	0.35 [8.9]	MK9	Heavy	—	UR 1565	N		
CT250600Q0	UV Black										—	
CT250800Q	Natural	8.00 [203.2]		28.74 [730]	0.35 [8.9]			—				
CT250800Q0	UV Black							—				
CT2501000Q	Natural	10.00 [254.0]		34.64 [880]	0.50 [12.7]			—				
CT2501200Q	Natural							12.00 [305.0]			40.00 [1016]	0.50 [12.7]
CT2501200Q0	UV Black	—										

UNIRAP™ Identification Cable Ties Type CT-ID

Identification cable ties are used in both bundling and identifying the wire groups at the same time. Same material, features and benefits as the Nylon 6/6 Standard Cable Ties.

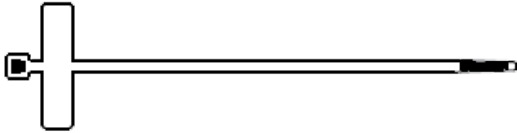

Fig. #2

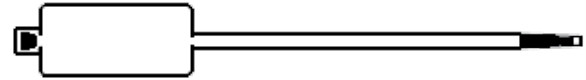

Fig. #1

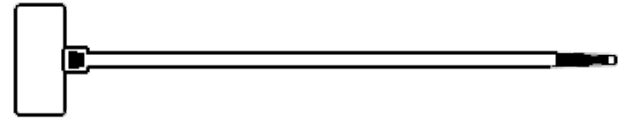

Fig. #3

Std Pkg Catalog Number	Material	Color	Fig.	Marking Pad Size Inches	Max Bundle Diameter Inches [mm]	Min Tensile Strength (lbs)	Length Inches [mm]	Width Inches [mm]
CT18075FLC	Nylon 6/6	Natural	3	.36 X .81	0.75 [19]	18	4.10 [104]	0.10 [2.5]
CT18075IDC			2	.33 X 1.00	0.75 [19]	18	4.01 [102]	0.10 [2.5]
CT18200IDC			2	.33 X 1.00	2.09 [53]	18	7.72 [196]	0.10 [2.5]
CT50175IDC			1	.51 X 1.09	1.75 [44]	50	7.48 [190]	0.18 [4.6]
CT50250IDC			1	.51 X 1.09	2.95 [75]	50	10.60 [269]	0.19 [4.8]

UNIRAP™ Push Mount Cable Ties Type CT-PM

Push Mount Cable Ties attach cable bundle to other surface through a pre-drilled hole. One piece design provides extra stability, reliability, and consistent performance. Same material and features as the Nylon 6/6 Standard Cable Ties.



Std Pkg Catalog Number	Material	Color	Max Bundle Diameter In. [mm]	Min Tensile Strength (lb)	Length Inches [mm]	Width Inches [mm]
CT50175PMC	Nylon 6/6	Natural	1.75 [44.5]	50	8.50 [216]	0.18 [4.6]
CT50175PMC0		UV Black				

Fir Tree Cable Tie Type CTFT

Fir Tree Mount Cable Ties provide low insertion pressure while providing high removal resistance for a solid fit. The fir tree allows for pre-installation assistance while mounted and then installed with ease. Provides protection in high vibration areas and applications.



Catalog Number	Material	Color	Max Bundle Diameter In. [mm]	Min Tensile Strength (lb)	Length Inches [mm]	Width Inches [mm]
CTFT50200C0	Nylon 6/6	UV Black	2.00" [50]	50	8.27 [210]	.19 [5]

UNIRAP™ Releasable Cable Ties Type CT-R

Perfect for prototype construction, releasable ties are ideal for temporary installations. Releasable ties are good for applications where service requires adding or subtracting wires from an existing bundle.

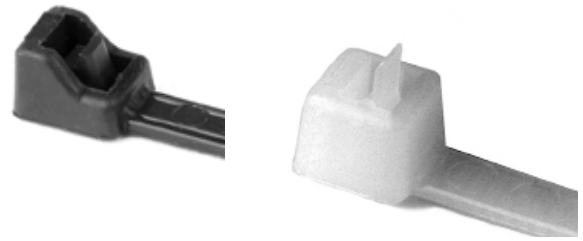

Std Pkg Catalog Number	Material	Color	Max Bundle Diameter In. [mm]	Min Tensile Strength (lbs)	Length Inches [mm]	Width Inches [mm]
CT50175RC	Nylon 6/6	Natural	2.13 [54.1]	50	8.00 [198]	0.19 [4]
CT50175RC0		UV Black				
CT50137RC		Natural	1.40 [35.6]	50	6.00 [151]	
CT50400RC		Natural	4.00 [101.6]	50	15.20 [387]	
CT50400RC0		UV Black				
CT250200RQ		Natural	2.52 [64.0]	250	9.50 [241]	0.49 [12.4]
CT250200RQ0		UV Black				
CT250500RQ		Natural	5.00 [127.0]	250	20.00 [509]	
CT250500RQ0		UV Black				
CT250600RQ		Natural	6.00 [152.4]	250	24.30 [618]	
CT250600RQ0		UV Black				
CT250800RQ		Natural	8.00 [203.2]	250	28.50 [724]	
CT250800RQ0		UV Black				
CT2501000RQ		Natural	9.76 [248.0]	250	32.60 [830]	

UNIRAP™ Metal Detectable Type CMDT

These ties are perfect for use in consumable products such as food processing applications, beverage, pharmaceutical, and cosmetic industries. The metal detectable ties are an excellent choice and are US FDA food contact material compliant*.

*Metal detectable material complies with the compositional requirements of US FDA regulations for Direct Food Contact; 21 CFR 177.1500 and 21 CFR 184.1375. Customer is responsible for ensuring the setting on metal detectable machines is adjusted and monitored for wet or dry products or environments, ferrous and non ferrous metals, type of food/products, packaging material speed, and orientation of scanned product.



Catalog Number (100 per package)	Material	Color	Max Bundle Diameter In. [mm]	Min Tensile Strength (lbs)	Length Inches [mm]	Width Inches
CMDT18075C5	Nylon 6/6 Metal content blended throughout	Teal	.87 [22.2]	18	4.12 [104.7]	.09
CMDT40225C5			2.47 [60.3]	40	8.87 [225.4]	.14
CMDT50175C5			1.87 [47.6]	50	7.56 [192.0]	.18
CMDT50300C5			3.00 [77.7]	50	11.25 [285.7]	.18
CMDT50400C5			4.00 [101.6]	50	14.25 [361.9]	.18
CMDT120400C5			4.00 [101.6]	120	15.09 [383.3]	.30

UNIRAP™ Mounting Hole Cable Ties Type CT-MH

Bundling and mounting, one easy installation. Ideal for use where bundle needs to be secured, such as control panels and ceilings. Can be bundled before or after mounting.



Std Pkg Catalog Number	Color	Screw Size	Max Bundle Diameter In. [mm]	Min Tensile Strength (lbs)	Length Inches [mm]	Width Inches [mm]	Bulk Catalog Number
CT18075MH4C	Natural	#4	0.75 [19.1]	18	3.93 [100]	0.10 [3.0]	CT18075MH4M
CT30125MH8C	Natural	#8	1.25 [31.8]	30	6.80 [173]	0.14 [4.0]	CT30125MH8M
CT30125MH8M0*	UV Black						—
CT50175MH10C	Natural	#10	1.75 [44.5]	50	8.10 [206]	0.18 [5.0]	CT50175MH10M
CT50175MH10C0	UV Black						CT50175MH10M0
CT50400MH10C	Natural	#10	4.00 [101.6]	50	15.10 [384]	0.18 [5.0]	—
CT50400MH10C0	UV Black						CT50400MH10M0
CT120400MH14L	Natural	1/4"	4.00 [101.6]	120	15.70 [399]	0.30 [8.0]	CT120400MH14D
CT120400MH14L0	UV Black						CT120400MH14D0

*Only available in Bulk Package of 1000 pieces.

UNIRAP™ Heat Stabilized Cable Ties Type CTHS

With similar properties and benefits as nylon 6/6, product manufactured with heat stabilized nylon 6/6 material have a chemical stabilizer added for higher continuous temperature applications. Range up to 225° F.

Features & Benefits

- Good fatigue resistance
- Resistant to chemicals
- Higher temperature range
- Meets the requirements of UL94V-2 flammability rating



Catalog Number	Material	Color	Max Bundle Diameter In. [mm]	Min Tensile Strength (lbs)	Length Inches [mm]	Width Inches [mm]
CTHS18075M	Nylon 6/6 Heat Stabilized	Natural	0.75 [19.1]	18	4.10 [104]	0.10 [2.5]
CTHS40125M			1.25 [31.8]	40	5.75 [146]	0.14 [3.6]
CTHS50300M			3.00 [76.2]	50	11.10 [282]	0.18 [4.6]
CTHS50400M			4.00 [101.6]	50	14.60 [371]	
CTHS50700M			1.88 [47.8]	50	7.60 [193]	
CTHS120400M			4.00 [101.6]	120	15.00 [381]	0.30 [7.6]

UNIRAP™ Standard Cable Tie Mounting Bases Type CTB

BURNDY® offers a wide variety of mounting bases suited for many applications. Mounting bases are used in conjunction with cable ties to stabilize and secure wire bundles, both indoors and outdoors. Mounting bases can be secured to a surface using rubber based adhesive, acrylic adhesive, or also can be screw mounted.

The Rubber Adhesive has an operating temperature range from 14°F/-10°C to 140°F/60°C; Acrylic Adhesive has a temperature range of 14°F/-10°C to 176°F/80°C. When using the screw mounting option ONLY (not using any adhesive to secure the base) the product has a temperature range of -40°F/-40°C to 185°F/85°C.

These mounting bases are available to accommodate CT18 through CT50 series cable ties. Insertion of ties can be made from all sides. Each mount may be secured with screws, adhesive backing, or both, for ease of application and stability. For applications where higher temperatures, certain chemicals, or UV radiation are a concern and an adhesive is the preferred method for securing, the acrylic adhesive mounting bases are recommended.



Fig. #1



Fig. #2



Fig. #3

Std Pkg Catalog Number	Mounting Method	Figure #	Color	Min Tensile Strength (lbs)	Max Tie Slot Width [mm]	Width Inches [mm]	Length Inches [mm]	Bulk Catalog Number
CTB075AAF1C	Acrylic Adhesive or #6 or #8 Screw	1	Natural	11	.17 [4.2]	0.75 [19]	0.75 [19]	CTB075AAF1M
CTB075AAF1C0	Acrylic Adhesive or #6 or #8 Screw	1	UV Black	11	.17 [4.2]	0.75 [19]	0.75 [19]	—
CTB075RAF1C	Rubber Adhesive or #6 or #8 Screw	1	Natural	11	.17 [4.2]	0.75 [19]	0.75 [19]	CTB075RAF1M
CTB075RAF1C0	Rubber Adhesive or #6 or #8 Screw	1	UV Black	11	.17 [4.2]	0.75 [19]	0.75 [19]	—
CTB075SF1C	#6 or #8 Screw Only	1	Natural	11	.17 [4.2]	0.75 [19]	0.75 [19]	CTB075SF1M
CTB100AAF2C	Acrylic Adhesive or #10 Screw	2	Natural	36	0.22 [5.5]	1.12 [28.4]	1.12 [28.4]	CTB100AAF2D
CTB100AAF2C0	Acrylic Adhesive or #10 Screw	2	UV Black	36	0.22 [5.5]	1.12 [28.4]	1.12 [28.4]	—
CTB100RAF2L	Rubber Adhesive or #10 Screw	2	Natural	36	0.22 [5.5]	1.12 [28.4]	1.12 [28.4]	CTB125RA4C
CTB100RAF2C0	Rubber Adhesive or #10 Screw	2	UV Black	36	0.22 [5.5]	1.12 [28.4]	1.12 [28.4]	—
CTB100SF2C	#6 or #8 Screw Only	2	Natural	36	0.22 [5.5]	1.12 [28.4]	1.12 [28.4]	—
CTB150AAF3C	Acrylic Adhesive or #10 Screw	3	Natural	58	0.39 [10]	1.51 [38.4]	1.51 [38.4]	CTB150AAF3D
CTB150RAF3C0	Rubber Adhesive or #10 Screw	3	UV Black	58	0.39 [10]	1.51 [38.4]	1.51 [38.4]	—
CTB150RAF3D	Rubber Adhesive or #10 Screw	3	Natural	58	0.39 [10]	1.51 [38.4]	1.51 [38.4]	—
CTB150SF3C	#10 Screw Only	3	Natural	58	0.39 [10]	1.51 [38.4]	1.51 [38.4]	—
CTB150RA4C	Rubber Adhesive or #10 Screw	3	Natural	58	0.39 [10]	1.51 [38.4]	1.51 [38.4]	—

UNIRAP™ Cable Hangers Type CH

Cable hangers provide a contact area range of 1/2" to 3/8" in width. All contact edges have a full radius for product protection, and sizes are clearly marked on each clamp.

Cable hangers are injection molded. Available in Natural and UV Black nylon 6/6.

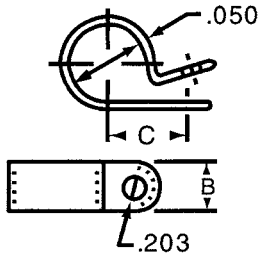

Catalog Number	Mounting Screw	Color	Maximum Bundle Inches [mm]	Dimension B Width Inches [mm]	Dimension C (Mount Hole to Center) Inches [mm]	Bulk Catalog Number
CH2C	#6 - #8 Screw	Natural	0.12 [3.1]	0.38 [9.7]	0.33	CH2M
CH2C0	#6 - #8 Screw	UV Black				—
CH3C	#10 Screw	Natural	0.19 [4.8]		0.43	CH3M
CH3C0	#10 Screw	UV Black				—
CH4C	#10 Screw	Natural	0.25 [6.4]		0.41	CH4M
CH4C0	#10 Screw	UV Black				CH4M0
CH5C	#10 Screw	Natural	0.31 [7.9]		0.50	CH5M
CH5C0	#10 Screw	UV Black				—
CH6C	#10 Screw	Natural	0.38 [9.7]		0.60	CH6M
CH6C0	#10 Screw	UV Black				CH6M0
CH8C	#10 Screw	Natural	0.50 [12.7]		0.61	CH8M
CH8C0	#10 Screw	UV Black				—
CH11C	#10 Screw	Natural	0.62 [15.8]	0.50 [12.7]	0.66	CH11M
CH12C	#10 Screw	Natural	0.75 [19.1]		0.78	CH12M
CH12C0	#10 Screw	UV Black				CH12M0
CH16C	#10 Screw	Natural	1.00 [25.4]		0.91	CH16M
CH18C	#10 Screw	Natural	1.12 [28.5]		0.97	CH18M
CH24L	#10 Screw	Natural	1.50 [38.1]		1.19	CH24C
CH24C0	#10 Screw	UV Black				—

UNIRAP™ Stainless Steel Barb Cable Ties Type CT-SSB

The Stainless Steel Barb cable ties (Type CT-SSB) are nylon 6/6 material featuring self-locking stainless steel barbs and oval low-profile head. There are no sharp edges helping prevent damaged cables. Type CT-SSB ties have a curved tip for faster initial threading and help speed installation. The no slip tail provides an easy grip during tensioning. Type CT-SSB ties are available in Natural and UV Black. These cable ties are cULus Listed for Wiring Positioning devices.



Features & Benefits

- Nylon 6/6 Standard
- Self-locking stainless steel barb
- Available in UV Black and Natural
- Maximum strength and adjustability for versatility
- Chemically resistant to solvents, oils, grease, and diluted acids
- Rounded edges and bent tail for easy installation
- Safe for air handling spaces
- Plenum Rated



Type 21

Standard Catalog Number	Color	Max Bundle Diameter In. [mm]	Tensile Strength (lbs)	Length Inches [mm]	Width Inches [mm]	Bulk Catalog Number	
CT18087SSBC	Natural	0.87 [22.0]	18	3.94 [100]	0.12 [3.0]	CT18087SSBM	
CT18087SSBC0	UV Black					CT18087SSBM0	
CT18100SSBC	Natural	0.91 [23.1]		4.02 [102]	0.09 [2.0]	CT18100SSBM	
CT18100SSBC0	UV Black					CT18100SSBM0	
CT18200SSBC	Natural	2.01 [51.1]		7.91 [201]		CT18200SSBM	
CT18200SSBC0	UV Black					CT18200SSBM0	
CT40137SSBC	Natural	1.38 [35.1]	40	5.91 [150]		0.14 [3.0]	CT40137SSBM
CT40137SSBC0	UV Black						CT40137SSBM0
CT40200SSBC	Natural	1.97 [50.0]		7.87 [200]	0.15 [4.0]	CT40200SSBD	
CT40200SSBC0	UV Black					CT40200SSBD0	
CT40300SSBC	Natural	3.15 [80.0]		11.18 [284]	0.14 [3.0]	CT40300SSBD	
CT40300SSBC0	UV Black					CT40300SSBD0	
CT40400SSBC	Natural	4.09 [103.9]	14.49 [368]	CT40400SSBD			
CT40400SSBC0	UV Black			CT40400SSBD0			
CT50175SSBC	Natural	1.77 [45.0]	50	7.32 [186]		0.19 [5.0]	CT50175SSBD
CT50175SSBC0	UV Black						CT50175SSBD0
CT50200SSBC	Natural	1.97 [50.0]		7.87 [200]	0.24 [6.0]	CT50200SSBB	
CT50200SSBC0	UV Black					CT50200SSBB0	
CT50250SSBC	Natural	2.56 [65.0]		9.84 [250]	0.19 [5.0]	CT50250SSBB	
CT50250SSBC0	UV Black					CT50250SSBB0	
CT50300SSBC	Natural	3.19 [81.0]	11.61 [295]	CT50300SSBB			
CT50300SSBC0	UV Black			CT50300SSBB0			

UNIRAP™ Stainless Steel Barb Cable Ties Type CT-SSB (Continued)

Standard Catalog Number	Color	Max Bundle Diameter In. [mm]	Tensile Strength (lbs)	Length Inches [mm]	Width Inches [mm]	Bulk Catalog Number		
CT50400SSBC	Natural	3.94	50	14.33	0.19	CT50400SSBB		
CT50400SSBC0	UV Black	[100.0]		[364]		[5.0]	CT50400SSBB0	
CT50425SSBC	Natural	4.21		14.96			CT50425SSBB	
CT50425SSBC0	UV Black	[106.9]		[380]			CT50425SSBB0	
CT110200SSBC	Natural	2.01	110	8.70	0.28	CT110200SSBB		
CT110200SSBC0	UV Black	[51.1]		[221]		[7.0]	CT110200SSBB0	
CT110225SSBL	Natural	2.24		9.45	0.32	CT110225SSBC		
CT110225SSBL0	UV Black	[57.0]		[240]		[8.0]	CT110225SSBC0	
CT110300SSBL	Natural	2.99		11.81	0.32	CT110300SSBC		
CT110300SSBL0	UV Black	[76.0]				[300]	[8.0]	CT110300SSBC0
CT110325SSBC	Natural	3.15			0.28	[7.0]	CT110325SSBB	
CT110325SSBC0	UV Black	[80.0]					CT110325SSBB0	
CT110350SSBL	Natural	3.62		13.78	0.32	CT110350SSBC		
CT110350SSBL0	UV Black	[92.0]		[350]		[8.0]	CT110350SSBC0	
CT110400SSBL	Natural	4.02		14.88	0.28	CT110400SSBC		
CT110400SSBL0	UV Black	[102.1]				[378]	[7.0]	CT110400SSBC0
CT110500SSBL	Natural	5.00				18.11	[460]	CT110500SSBC
CT110500SSBL0	UV Black	[127.0]						CT110500SSBC0
CT110600SSBL	Natural	5.98				21.18	[538]	CT110600SSBC
CT110600SSBL0	UV Black	[151.9]						CT110600SSBC0
CT110800SSBL	Natural	7.99	27.52			[699]	CT110800SSBC	
CT110800SSBL0	UV Black	[203.0]					CT110800SSBC0	
CT120300SSBL	Natural	3.15	11.81			0.39	CT120300SSBC	
CT120300SSBL0	UV Black	[80.0]					[300]	[10.0]
CT120350SSBL	Natural	3.82		13.78	[350]		CT120350SSBC	
CT120350SSBL0	UV Black	[97.0]					CT120350SSBC0	
CT120400SSBL	Natural	4.33		15.75	[400]		CT120400SSBC	
CT120400SSBL0	UV Black	[110.0]					CT120400SSBC0	
CT120500SSBL	Natural	4.92		17.72	[450]		CT120500SSBC	
CT120500SSBL0	UV Black	[125.0]					CT120500SSBC0	

UNIRAP™ Universal Grade Cable Ties Type CT-UG

General purpose nylon 6/6 ties feature light weight, high strength and a wide temperature range. It is halogen free so it does not release dangerous gases, such as chlorine, bromine, fluorine, or iodine when burned. Nylon 6/6 is hygroscopic, and therefore, absorbs or releases moisture depending on its environment. The moisture level of the material will affect tensile strength, stiffness and elongation of the product.

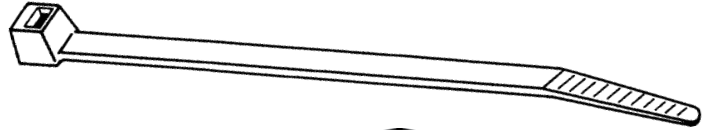

Features & Benefits

- Nylon 6/6 Standard
- Available in UV Black and Natural
- One piece injection molded
- Maximum strength and adjustability for versatility
- Chemically resistant to solvents, oils, grease, and diluted acids
- Rounded edges and bent tail for easy installation
- Self-locking

Std Pkg Catalog Number	Color	Max. Bundle Dia. (in) [mm]	Min. Tensile Strength (lb)	Length inch [mm]	Width inch [mm]	Bulk Pkg Catalog Number
Nylon UNIRAP - 18 Lb. Tensile Strength						
CT18075CUG	Natural	0.75 [19.1]	18	3.94 [101]	0.10 [2.5]	CT18025MUG
CT18075C0UG	UV Black			7.95 [202]		CT18025M0UG
—	Natural	2.00 [50.8]				CT18200MUG
CT18200C0UG	UV Black			CT18200M0UG		
Nylon UNIRAP - 30 Lb. Tensile Strength						
CT30125CUG	Natural	1.25 [31.8]	30	5.90 [150]	0.13 [3.3]	CT30125MUG
CT30125C0UG	UV Black			—		
Nylon UNIRAP - 40 Lb. Tensile Strength						
CT40200CUG	Natural	2.00 [50.8]	40	7.90 [201]	0.15 [3.8]	CT40200MUG
CT40400C0UG	UV Black	4.00 [101.6]		14.50 [368]		—
Nylon UNIRAP - 50 Lb. Tensile Strength						
CT50175CUG	Natural	1.75 [44.5]	50	7.83 [199]	0.18 [4.6]	CT50175MUG
CT50175C0UG	UV Black			11.34 [288]		CT50175M0UG
CT50300CUG	Natural	3.00 [76.2]				14.60 [371]
CT50300C0UG	UV Black			CT50300M0UG		
CT50400CUG	Natural	4.00 [101.6]		CT50400MUG		
CT50400C0UG	UV Black			—		

UNIRAP™ Universal Grade Cable Ties Type CT-UG (Continued)

Std Pkg Catalog Number	Color	Max. Bundle Dia. (in) [mm]	Min. Tensile Strength (lb)	Length inch [mm]	Width inch [mm]	Bulk Pkg Catalog Number
Nylon UNIRAP - 120 Lb. Tensile Strength						
CT120200L0UG	UV Black	2.00 [50.8]	120	8.87 [225]	0.28 [7.1]	—
CT120400LUG	Natural	4.00 [101.6]		14.57 [370]		—
CT120400L0UG	UV Black			17.70 [450]		CT120400C0UG
CT120500CUG	Natural	5.00 [127.0]		29.75 [756]		—
CT120900LUG	Natural	9.00 [228.6]		—		
Nylon UNIRAP - 175 Lb. Tensile Strength						
CT175400Q0UG	UV Black	4.00 [101.6]	175	15.00 [381]	0.35 [8.9]	—
CT175600QUG	Natural	6.00 [152.4]		21.00 [533]		—
CT175600Q0UG	UV Black			32.00 [813]		—
CT175900Q0UG	UV Black	9.00 [228.6]		36.00 [914]		—
CT1751100QUG	Natural	11.00 [279.4]		52.00 [1321]		—
CT1751100Q0UG	UV Black			—		
CT1751400QUG	Natural	14.00 [355.6]		—		
Nylon UNIRAP - 250 Lb. Tensile Strength						
CT250800Q0UG	UV Black	8.00 [203.2]	250	29.00 [737]	0.50 [12.7]	—

UNIRAP™ Universal Grade Cable Ties with Mounting Hole; Type CT-MH-UG

The CT-MH-UG Cable Ties use the same material and have the same benefits of our CT-UG Cable Ties with the addition of a mounting hole. General purpose nylon 6/6 features light weight, high strength and a wide temperature range. It is halogen free so it does not release dangerous gases, such as chlorine, bromine, fluorine or iodine when burned. Nylon 6/6 is hygroscopic, and therefore, absorbs or releases moisture depending on its environment. Thus, the moisture level of the material will affect tensile strength, stiffness and elongation of the product.

Features & Benefits

- Nylon 6/6 Standard
- Available in UV Black and Natural
- One piece injection molded
- Maximum strength and adjustability for versatility
- Chemically resistant to solvents, oils, grease, and diluted acids
- Rounded edges and bent tail for easy installation
- Self-locking



Std Pkg Catalog Number	Color	Screw Size	Max Bundle Diameter Inches [mm]	Min Tensile Strength (lbs)	Length Inches [mm]	Width Inches [mm]
CT50175MH10CUG	Natural	#10	1.75 [44.5]	50	7.79 [198]	0.18 [4.6]
CT50175MH10C0UG	UV Black			50		
CT50300MH10CUG	Natural		3.00 [76.2]	50	11.73 [298]	
CT50300MH10C0UG	UV Black			50		

UNIRAP™ Universal Grade Cable Tie Mounting Bases; Type CTB-UG

These cable tie mounting bases may be secured with 2 screws and/or a rubber-based adhesive for ease of applications and stability. These bases are suited for many applications to stabilize and secure wire bundles, both indoors and outdoors.

Features & Benefits

- Nylon 6/6 Standard
- Chemically resistant to solvents, oils, grease, and diluted acids

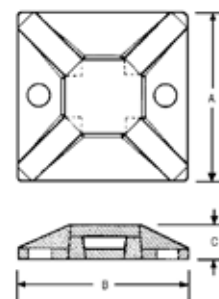

Std Pkg Catalog Number	Mounting Method	Max Tie Slot Width [mm]	Dimension A [mm]	Dimension B [mm]	Dimension C [mm]	Bulk Catalog Number
CTB075RA4CUG	Rubber Adhesive	0.14 [3.56]	0.75 [19.0]	0.75 [19.0]	0.15 [3.8]	—
CTB125RA4CUG	Rubber Adhesive	0.20 [5.08]	1.125 [28.6]	1.125 [28.6]	0.19 [4.8]	CTB125RA4DUG

UNIRAP™ Cable Tie Variety Canister Type CTASST

There are times when a variety of lengths and color would be helpful. The Type CTASST Cable Tie Variety Canister is perfect when your needs change.



Catalog Number	Contains					
	Quantity	Color	Max Bundle Diameter	Tensile Strength (lbs)	Length Inches [mm]	Width Inches [mm]
CTASST	100	Natural	0.75 [19.1]	18	3.94 [100]	0.10 [2.5]
	100	UV Black				
	200	Natural	1.75 [44.5]	50	7.99 [203]	0.13 [3.2]
	100	UV Black				
	50	Natural	3.00 [76.2]	50	11.02 [280]	0.19 [4.8]
	50	UV Black				

UNIRAP™ Nylon 12 Cable Ties Type CTNT



CABLE TIE
33TX

Nylon 12 cable ties provide excellent UV, chemical and moisture resistance. The ties feature inside serrations and a bent tail for quick and easy installation. Manufactured from polyamide 12 the ties also have a smooth edge to prevent bundle damage. Especially suitable in high moisture, corrosive (zinc chloride and dilute acids) environments or where low temperatures are a factor. Indoor or outdoor applications.



Std Pkg Catalog Number	Color	Max. Bundle Dia. In. [mm]	Min. Tensile Strength (lb)	Length	Width	Bulk Pkg Catalog Number
				in [mm]	in [mm]	
CTNT50200C0	UV Black	2.00 [50]	50	7.50 [190]	0.19 [4.8]	CTNT50200D0
CTNT50275C0	UV Black	2.75 [70]		11.00 [280]		CTNT50275D0
CTNT50350C0	UV Black	3.50 [90]		13.78 [350]		CTNT50350D0
CTNT120600L0	UV Black	6.00 [152]	120	24.00 [609]	0.31 [7.0]	—

VELCRO® Hook and Loop Straps Type TFV-B

Reusable and flexible, hook and loop straps are a unique self-gripping fastening system. These ties are specifically used on fiberoptic applications.

The TFV-V2 flame retardant straps are UL Listed Wire Positioning Devices (ZODZ), UL94-V2 rated for use in air handling spaces in accordance with the NEC Section 300-22(c) and (d). Perfect for plenum areas.

25 straps are conveniently packaged in each polybag.

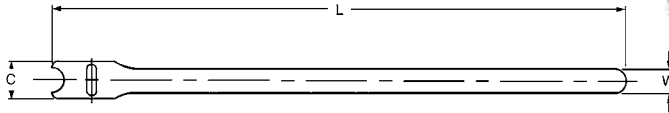

Catalog Number	Product Description	Max Bundle Diameter [mm]	C [mm]	L [mm]	W [mm]	T	Avg. Sheer (PSI)	Avg. Peel (PIW)	Pkg. Qty.
TFV3B12V2	VELCRO® hook and loop strap, 3/4" x 12", Black, 25pk	3.00 [76.2]	0.75 [19.1]	12.00 [305]	0.50 [.27]	0.09	29	0.60	1 package = 25 ties
TFV3B18V2	VELCRO® hook and loop strap, 3/4" x 18", Black, 25pk	5.00 [127.0]		18.00 [457]			29	0.60	
TFV3B6V2	VELCRO® hook and loop strap, 3/4" x 6", Black, 25pk	1.00 [25.4]		6.00 [152]			29	0.60	
TFV3BLU12	VELCRO® hook and loop strap, 3/4" x 12", Royal Blue, 25pk	3.00 [76.2]		12.00 [305]			23	0.50	
TFV3BLU18	VELCRO® hook and loop strap, 3/4" x 18", Royal Blue, 25pk	5.00 [127.0]		18.00 [457]			23	0.50	

TEFZEL® Cable Ties Type CTZ

TEFZEL® Fluoropolymer ties feature a low smoke density with excellent flammability rating (UL 94V-0) and tolerates extreme high and low temperatures. TEFZEL® ties come in distinctive aqua blue color with an operating temperature of Min. -112°F (-80°C), Max. 338°F (170°C).

TEFZEL® is a Registered trademark of E.I. du Pont de Nemours and Company.



Catalog Number	Tensile	Max Bundle Diameter	Length	Pkg Qty
CTZ18075C6	18 lb	.87"	4.00"	100
CTZ18125C6	18 lb	1.39"	6.25"	100
CTZ30200C6	30 lb	2.00"	4.00"	100
CTZ50175C6	50 lb	1.75"	7.75"	100
CTZ50300C6	50 lb	3.00"	11.00"	100
CTZ50400C6	50 lb	4.00"	14.50"	100
CTZ100300C6	100 lb	3.00"	11.00"	50
CTZ100400C6	100 lb	4.00"	14.50"	50

UNIRAP™ Grade 304 Stainless Steel; Uncoated Type CTSS

BURNDY® 304 Stainless Steel ties are designed to secure hoses, cables, poles, pipes, and more when harsh environmental conditions may adversely affect the bundling application.

Used where corrosion, vibration, weathering, radiation, and temperature extremes are a concern. BURNDY® Stainless Steel ties can be used in virtually any indoor, outdoor, and underground application.

These Stainless Steel ties are made from Grade 304 Stainless Steel. Designed with a low profile clamping bearing head with fully adjustable strap accommodating many bundle diameters.



Features & Benefits

- Meet ABS Requirements
- 304 Grade Stainless Steel
- Suitable for general purpose applications
- Smooth, rounded edges help ensure safe, efficient handling
- Available in a variety of lengths and widths
- Self-locking steel ball design speeds installation and locks into place at any length
- Provides a strong, durable method of cable bundling
- Flame retardant and non-toxic for applications where safety from fire is critical

Catalog Number	Material	Max Bundle Diameter In. [mm]	Min Tensile Strength Lbs.	Length Inches [mm]	Width Inches [mm]	Installation Tool
CTSS225100304C	304 SS	0.99 [25.2]	225	3.94 [100]	0.18 [4.6]	CTTSS900
CTSS225200304C		1.97 [50.0]		7.87 [200]		
CTSS225300304C		3.00 [76.2]		11.81 [300]		
CTSS225400304C		4.02 [102.1]		15.75 [400]		
CTSS225500304C		5.04 [128.0]		19.68 [500]		
CTSS225600304C		6.07 [154.2]		23.62 [600]		
CTSS500200304L	304 SS	1.97 [50.0]	500	7.87 [200]	0.31 [7.9]	CTTSS900
CTSS500300304L		3.00 [76.2]		11.81 [300]		
CTSS500400304L		4.02 [102.1]		15.75 [400]		
CTSS500500304L		5.04 [128.0]		19.68 [500]		
CTSS500600304L		6.07 [154.2]		23.62 [600]		
CTSS500700304L		7.09 [180.1]		27.56 [700]		
CTSS500750304L		7.60 [193.0]		31.50 [800]		
CTSS500800304L		8.12 [206.3]		39.37 [1000]		
CTSS700200304L	304 SS	1.97 [50.0]	700	7.87 [200]	0.50 [12.7]	CTTSS900
CTSS700300304L		3.00 [76.2]		11.81 [300]		
CTSS700400304L		4.02 [102.1]		15.75 [400]		
CTSS700500304L		5.04 [128.0]		19.68 [500]		
CTSS700600304L		6.07 [154.2]		23.62 [600]		
CTSS700700304L		7.09 [180.1]		27.56 [700]		
CTSS700800304L		8.12 [206.3]		39.37 [1000]		
CTSS900200304L	304 SS	1.97 [50.0]	920	7.87 [200]	0.62 [15.9]	CTTSS900
CTSS900300304L		3.00 [76.2]		11.81 [300]		
CTSS900400304L		4.02 [102.1]		15.75 [400]		
CTSS900500304L		5.04 [128.0]		19.68 [500]		
CTSS900600304L		6.07 [154.2]		23.62 [600]		
CTSS900700304L		7.09 [180.1]		27.56 [700]		
CTSS900800304L		8.12 [206.3]		39.37 [1000]		

**UNIRAP™ Grade 304 Stainless Steel;
Partially Coated; Type CTSS-PC**

BURNDY® Stainless Steel Partially Coated cable ties (Type CTSS-PC) are designed with a steel ball self-locking mechanism. There are no sharp edges which prevents damaged cables. These ties have smooth, rounded edges and polyester coating which add to the safety of the installer. High tensile strength along with the shield of the polyester coating offer a reliable and lasting bundling solution. CTSS-PC ties are currently available in black. BURNDY® Stainless Steel Partially Coated Cable Ties can be used in any indoor, outdoor, or underground application.



Features & Benefits

- Meet ABS Requirements
- 304 Grade Stainless Steel
- Available in Black only
- Suitable for general purpose applications
- Smooth, rounded edges along with the polyester coating add to the safety of the installer
- Self-locking steel ball design speeds installation and locks into place at any length
- Provides a strong, durable method of cable bundling
- Available in a wide range of lengths and widths
- Halogen free low smoke polyester coating

Catalog Number	Material	Max Bundle Diameter In. [mm]	Min Tensile Strength Lbs.	Length Inches [mm]	Width Inches [mm]	Installation Tool
CTSS250200PC304L	304 SS	1.97 [50.0]	270	7.87 [200]	0.31 [7.9]	CTTSS900
CTSS250300PC304L		3.00 [76.2]		11.81 [300]		
CTSS250400PC304L		4.02 [102.1]		15.75 [400]		
CTSS250500PC304L		5.04 [128.0]		19.68 [500]		
CTSS250600PC304L		6.06 [153.9]		23.62 [600]		
CTSS250700PC304L		7.09 [180.1]		27.56 [700]		
CTSS250800PC304L		8.11 [206.0]		39.37 [1000]		
CTSS450200PC304L	304 SS	1.97 [50.0]	450	7.87 [200]	0.50 [12.7]	CTTSS900
CTSS450300PC304L		3.00 [76.2]		11.81 [300]		
CTSS450400PC304L		4.02 [102.1]		15.75 [400]		
CTSS450500PC304L		5.04 [128.0]		19.68 [500]		
CTSS450600PC304L		6.06 [153.9]		23.62 [600]		
CTSS450700PC304L		7.09 [180.1]		27.56 [700]		
CTSS450800PC304L		8.11 [206.0]		39.37 [1000]		
CTSS675200PC304Q	304 SS	1.97 [50.0]	675	7.87 [200]	0.62 [15.9]	CTTSS900
CTSS675300PC304Q		3.00 [76.2]		11.81 [300]		
CTSS675400PC304Q		4.02 [102.1]		15.75 [400]		
CTSS675500PC304Q		5.04 [128.0]		19.68 [500]		
CTSS675600PC304Q		6.06 [153.9]		23.62 [600]		
CTSS675700PC304Q		7.09 [180.1]		27.56 [700]		
CTSS675800PC304Q		8.11 [206.0]		39.37 [1000]		

UNIRAP™ Grade 304 Stainless Steel; Fully Coated; Type CTSS-FC

The Stainless Steel Fully Coated cable ties (Type CTSS-FC) are designed with a steel ball type locking mechanism. There are no sharp edges which prevents damaged cables. These ties have smooth, rounded edges and polyester coating which add to the safety of the installer. High tensile strength along with the shield of the polyester coating offers a reliable and lasting bundling solution. Type CTSS-FC ties are currently available only in black. BURNDY® stainless steel fully coated cable ties can be used in any indoor, outdoor, or underground applicaiton.

Features & Benefits

- Meet ABS Requirements
- 304 Grade Stainless Steel
- Available in Black only
- Suitable for general purpose applications
- Smooth, rounded edges along with the polyester coating add to the safety of the installer
- Self-locking steel ball design speeds installation and locks into place at any length
- Provides a strong, durable method of cable bundling
- Available in a wide range of lengths and widths
- Halogen free low smoke polyester coating



Catalog Number	Material	Max Bundle Diameter In. [mm]	Min Tensile Strength Lbs.	Length Inches [mm]	Width Inches [mm]	Installation Tool
CTSS100100FC304C	304 SS	0.98 [24.9]	160	3.94 [100]	0.18 [4.6]	CTTSS900
CTSS100200FC304C		1.97 [50.0]		7.87 [200]		
CTSS100300FC304C		3.00 [76.2]		11.81 [300]		
CTSS100400FC304C		4.02 [102.1]		15.75 [400]		
CTSS100500FC304C		5.04 [128.0]		19.68 [500]		
CTSS100600FC304C		6.07 [154.2]		23.62 [600]		
CTSS100800FC304C		8.11 [206.0]		31.50 [800]		
CTSS250200FC304L	304 SS	1.97 [50.0]	250	7.87 [200]	0.31 [7.9]	CTTSS900
CTSS250300FC304L		3.00 [76.2]		11.81 [300]		
CTSS250400FC304L		4.02 [102.1]		15.75 [400]		
CTSS250500FC304L		5.04 [128.0]		19.68 [500]		
CTSS250600FC304L		6.06 [153.9]		23.62 [600]		
CTSS250700FC304L		7.09 [180.1]		27.56 [700]		
CTSS250800FC304L		8.11 [206.0]		39.37 [1000]		
CTSS450200FC304L	304 SS	1.97 [50.0]	450	7.87 [200]	0.50 [12.7]	CTTSS900
CTSS450300FC304L		3.00 [76.2]		11.81 [300]		
CTSS450400FC304L		4.02 [102.1]		15.75 [400]		
CTSS450500FC304L		5.04 [128.0]		19.68 [500]		
CTSS450600FC304L		6.06 [153.9]		23.62 [600]		
CTSS450700FC304L		7.09 [180.1]		27.56 [700]		
CTSS450800FC304L		8.11 [206.0]		39.37 [1000]		
CTSS675200FC304Q	304 SS	1.97 [50.0]	675	7.87 [200]	0.62 [15.9]	CTTSS900
CTSS675300FC304Q		3.00 [76.2]		11.81 [300]		
CTSS675400FC304Q		4.02 [102.1]		15.75 [400]		
CTSS675500FC304Q		5.04 [128.0]		19.68 [500]		
CTSS675600FC304Q		6.06 [153.9]		23.62 [600]		
CTSS675700FC304Q		7.09 [180.1]		27.56 [700]		
CTSS675800FC304Q		8.11 [206.0]		39.37 [1000]		

Wiley Bundle Straps

High-quality wire management solutions

The Wiley Bundle Strap is made of corrosion resistant 304 stainless steel, which makes for a durable, long lasting and reliable solution for all environments. The vinyl jacket covering the stainless steel wire is designed to protect cable insulation from damage. The Wiley Bundle Strap is easy to install and can be crimped in the field with electrician linesman pliers or standard wire cutters. The crimp sleeve's retention feature allows for a quick, effortless, secure installation. Custom lengths available upon request.

Features and Benefits:

- UL 62275 Listed
- High quality, long-lasting, labor saving, wire management solution
- UV rated vinyl jacketed stainless steel wire with 304 stainless steel crimp
- Vinyl jacket designed to protect cable insulation from damage
- 304 stainless steel crimp sleeve allows for quick and easy installation
- Can be crimped in the field with electrician linesman pliers or standard wire cutters
- Retention feature allows for a quick, effortless, secure installation
- Lasts for the lifetime of the PV system
- RoHS compliant
- Custom lengths available upon request



Installing the ACC-FBC with WBS or UNIRAP™ cable tie

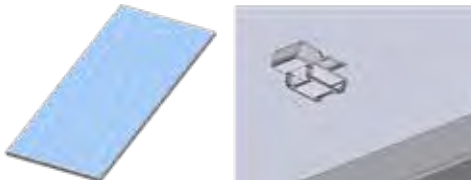

The ACC-FBC mounting base slides onto the module flange



Route a WBS or UNIRAP™ through the ACC-FBC mounting base



Secure desired cables by tightening the WBS or UNIRAP™

Wiley Bundle Straps

304 Stainless Steel wire covered with vinyl jacket helps protect cable insulation from damage

Catalog Number	Length inch [mm]	Diameter inch [mm]	Max. Tensile Strength	Max. Bundle Diameter inch [mm]	Material
WBS8V	8.00 [203.20]	0.06 [1.50]	100 lbs.	2.30 [58.40]	Vinyl Insulated 304 Stainless Steel Wire
WBS10V	10.00 [254.00]	0.06 [1.50]	100 lbs.	2.92 [74.00]	
WBS12V	12.00 [304.80]	0.06 [1.50]	100 lbs.	3.88 [98.50]	
WBS14V	14.00 [356.00]	0.06 [1.50]	100 lbs.	4.20 [106.70]	
WBS20V	20.00 [508.00]	0.06 [1.50]	100 lbs.	6.36 [161.50]	
WBS24V	24.00 [609.60]	0.06 [1.50]	100 lbs.	7.00 [178.00]	
WBS30V	30.00 [762.00]	0.06 [1.50]	100 lbs.	8.75 [222.00]	
WBS36V	36.00 [914.40]	0.06 [1.50]	100 lbs.	11.00 [279.40]	

Mounting Platform for WBS Bundle Straps or UNIRAP™ Cable Ties

304 Stainless Steel cable clip used for affixing cable ties to a module flange or similar flange.

Catalog Number	Length inch [mm]	Width inch [mm]	Height inch [mm]	Max. Cable Tie Width inch [mm]	Frame Thickness
ACC-FBC	0.55 [14.00]	0.48 [12.20]	0.27 [7.00]	0.31 [8.00]	1.3mm to 2.5mm

Coated P-Clips

Wiley coated products are a durable, long lasting and reliable solution for protecting wires and cables. The vinyl coating acts as a shield against vibration and cable insulation damage. Wiley coated P-Clips easily install into a mounting hole with 1/4" hardware.

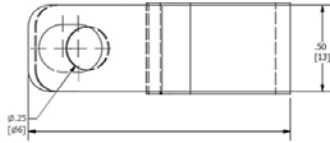

Wiley Coated P-Clips				
<i>Vinyl coated steel p-clips protect cables from vibration and insulation damage.</i>				
Catalog Number	Width inch [mm]	Max. Bundle Diameter inch [mm]	Material	UL
WIPC14-14	0.24 [6.0]	0.25 [6.4]	PVC coated zinc plated steel	UL 1565 Listed
WIPC14-12	0.24 [6.0]	0.50 [13.0]		
WIPC14-34	0.24 [6.0]	0.75 [19.0]		
WIPC14-1	0.24 [6.0]	1.00 [25.4]		
WIPC14-112	0.24 [6.0]	1.50 [38.0]		



WCH - Wiley Cable Hanger Family Steel Bundle Securement

The WILEY Cable Hanger family is designed specifically to support cables via mounting or wire management holes in either the module frame or secured around a tracker bolt in a fast, easy one-step hook application. The WCH1(GS) and WCH2(GS) models are compatible with all common module frame geometries including First Solar Series 6. Additionally, the WCH2B10 and WCH2H1090 models are set at a 90o angle making them ideal for use with bi-facial panels. The round cross-section of the hanger ensures the cable insulation is protected from chafing in high wind and tracker applications. Offered in either Stainless or galvanized steel construction both provide a solution made to last. The round bundle compartment securely holds runs of up to 8 or 16 wires up to 8mm in diameter without allowing significant shifting from tracker movement or wind.



Catalog Number	Material	Bundle Dia.	Wire Accommodation	Installation Location
WCH1	300 Series SS	1.0" [25.4mm]	up to 8 PV wires	Mounting/Wire Mgmt Hole
WCH1GS	Galvanized Steel	1.0" [25.4mm]	up to 8 PV wires	Mounting/Wire Mgmt Hole
WCH2	300 Series SS	2.0" [50.8mm]	up to 20 PV wires	Mounting/Wire Mgmt Hole
WCH2GS	Galvanized Steel	2.0" [50.8mm]	up to 20 PV wires	Mounting/Wire Mgmt Hole
WCH2B10	300 Series SS	2.0" [50.8mm]	up to 20 PV wires	Tracker Bolt
WCH2B10GS	Galvanized Steel	2.0" [50.8mm]	up to 20 PV wires	Tracker Bolt
WCH2H1090	300 Series SS	2.0" [50.8mm]	up to 20 PV wires	Tracker Bolt
WCH2H1090GS	Galvanized Steel	2.0" [50.8mm]	up to 20 PV wires	Tracker Bolt

Vinyl coating available upon request







Wiley Cable Clips High-quality wire management solutions

Engineered for high-quality wire management solutions, Wiley Cable Clips simplify wire management and create a cleaner aesthetic to solar PV arrays. The clips are made of corrosion resistant stainless steel, which makes for a durable, long lasting and reliable solution in all environments and are designed with coined and rolled edges to prevent damage to cable insulation. The designs are easy to install and remove with a flat head screwdriver. The clips can be used in a wide variety of mounting configurations (including 90 and 180 degrees) for module and rail applications. Custom designs are available upon request.

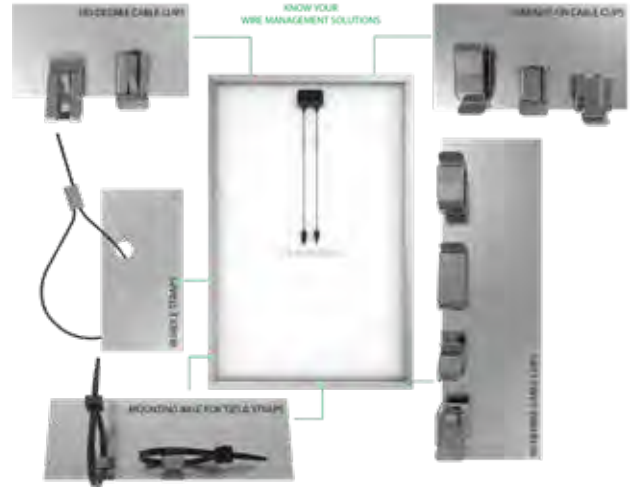











Features and Benefits:

- UL 1565 Listed
- Accommodates a broad range of cable combinations and sizes (e.g., USE-2, PV, AC module, and micro inverter cables)
- Environmentally tested - UL 2703 and ASTM B117
- No tools required for installation
- Coined and rolled edges to prevent damage to cable insulation
- Reliability for use throughout the lifetime of the PV system



Flange Clips				
304 Stainless Steel cable clips that install on the module frame or other equipment flange.				
Line Image	Catalog Number	Qty of Wires Held	Wire Diameter inch [mm]	Flange Thickness Accommodated
	ACC	1 to 2 USE-2 wires or 1 PV wire	Max. 0.216 [5.50]	1.3 - 2.5mm
	ACC-PV	1 to 2 PV wires	Max. 0.275 [7.00]	1.3 - 2.5mm
	ACC-FPV	1 to 2 PV wires	Max. 0.314 [8.00]	1.0 - 3mm

Wiley Cable Clips (Continued)

90 Degree Flange Clips				
304 Stainless Steel cable clips that install parallel or perpendicular on the module frame or other equipment flange.				
Line Image	Catalog Number	Qty of Wires Held	Wire Diameter inch [mm]	Flange Thickness Accommodated
	ACC-F90-1	1 to 2 USE-2 wires or 1 to 2 PV wire	Max. 0.29 [7.50]	1.3 - 2.5mm
	ACC-FPV90	1 to 2 PV wires	Max. 0.314 [8.00]	1.0 - 3.0mm
	ACC-F2-90	1 to 2 Micro Inverter Trunk or AC cables	1 wire: Max. 0.55 [14.00] 2 wires Max. 0.43 [11.00]	1.3 - 2.5mm
	ACC-F4-90-1	1 to 4 PV wires	Max. 0.29 [7.50]	1.3 - 2.5mm
	ACC-F490	1 to 4 PV wires	Max. 0.314 [8.00]	1.0 - 3.0mm
	ACC-F4F	1 to 4 PV wires	Max. 0.314 [8.00]	1.0 - 3.0mm
	ACC-F1-270	2 PV wire or 1 Micro Inverter Trunk	Max. 0.55 [14.00]	1.0 - 3.0mm
180 Degree Flange Clips				
304 Stainless Steel cable clips that install on the flange at 180 degrees.				
Line Image	Catalog Number	Qty of Wires Held	Wire Diameter inch [mm]	Flange Thickness Accommodated
	ACC-FPV180	1 to 2 PV wires	Max. 0.314 [8.00]	1.0 - 3.0mm
	ACC-F1-270	1 to 2 PV wires or 1 Micro Inverter Trunk	Max. 0.55 [14.00]	1.0 - 3.0mm
	ACC-FF180	1 to 2 PV wires	Max. 0.314 [8.00]	1.0 - 3.0mm
Rail Clips				
304 Stainless Steel cable clips that install on the rail, channel, or slot.				
Line Image	Catalog Number	Qty of Wires Held	Wire Diameter inch [mm]	Rail Type
	ACC-R2	1 to 2 Micro Inverter Trunk or AC cables	1 wire: Max. 0.55 [14.00] 2 wires Max. 0.43 [11.00]	Unirac, Ironrige or Similar Style
	ACC-R4	1 to 4 PV wires	Max. 0.29 [7.50]	Unirac, Ironrige or Similar Style
	ACC-RBC15	2 Micro Inverter Trunk or up to 4 PV wires	Max. 0.55 [14.00]	Rail Channel or Slot Width: 6.35mm to 13.5mm



ACC-F90-1 shown in both orientations



ACC-F1-270



ACC-FPV180



ACC-F4F



ACC-RBC15 shown

Wiley Edge Clip with Cable Tie (ACC-ECT)
High-quality wire management solutions

The WILEY ACC-ECT is the perfect solution to route cable bundles without the need for mounting holes or additional hardware. The ACC-ECT is a nylon-encased plated steel clip that installs onto the module frame flange and allows a cable tie to be routed in both landscape (on the horizontal/perpendicular portion of the module frame) and portrait (on the vertical/parallel portion of the module frame) orientations. The ACC-ECT is available in UV resistant, high impact heat stabilized nylon 6/6 and nylon 12 material; both the 6/6 and 12 have a tensile strength of 50 lb. Nylon 12 makes the ACC-ECT especially suitable in high moisture, corrosive environments or where low temperatures are a factor.

Features and Benefits:

- Route cable bundles without the need for mounting holes or additional hardware
- Installs in a vertical/parallel (90°) or horizontal/perpendicular (180°) orientation
- Steel lances securely anchor clips to module frames or purlins
- Offered in various nylon types with 50 lb tensile strength:
 - UV resistant, high impact heat stabilized Nylon 6/6
 - UV resistant Nylon 12 which provides excellent UV, chemical and moisture resistance



Style A - Vertical/Parallel Installation



Style B - Horizontal/Perpendicular Installation

Style A - Vertical/Parallel Installation

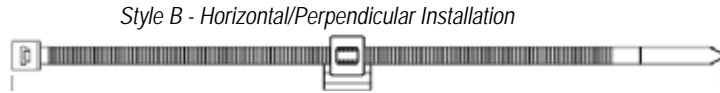

Style B - Horizontal/Perpendicular Installation

Part Key		
Family	ACC	Acme Cable Clip
Type	ECT	Edge Clip Tie
Style	A	Vertical/Parallel (90°) Installation
	B	Horizontal/Perpendicular (180°) Installation

Catalog Number	Style	Nylon Type	Cable Tie Length	Max. Bundle Dia.
ACC-ECTA68	A	6/6	8" / 200mm	1.95" / 49.5mm
ACC-ECTA611			11" / 280mm	2.95" / 74.8mm
ACC-ECTA614			14" / 360mm	3.94" / 100mm
ACC-ECTA128		12	8" / 200mm	1.95" / 49.5mm
ACC-ECTA1211			11" / 280mm	2.95" / 74.8mm
ACC-ECTA1214			14" / 360mm	3.94" / 100mm
ACC-ECTB68	B	6/6	8" / 200mm	1.95" / 49.5mm
ACC-ECTB611			11" / 280mm	2.95" / 74.8mm
ACC-ECTB614			14" / 360mm	3.94" / 100mm
ACC-ECTB128		12	8" / 200mm	1.95" / 49.5mm
ACC-ECTB1211			11" / 280mm	2.95" / 74.8mm
ACC-ECTB1214			14" / 360mm	3.94" / 100mm

Edge Clip Compartment

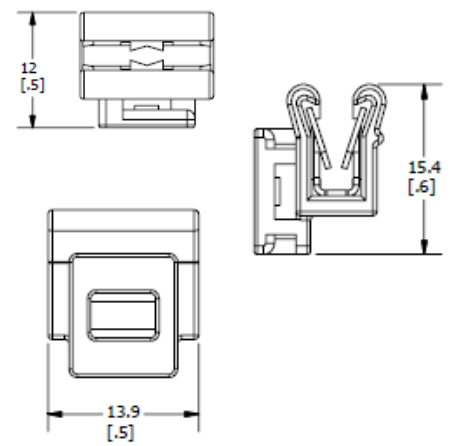

Cable Tie Tools Types CTTSS

Ergonomics and the prevention of repetitive motion injuries, coupled with the need to continually improve assembly efficiencies and procedures, are a major concern with most cable tie users. BURNDY® cable tie tools effectively address both issues. BURNDY® has world class cable tie tools to complement its line of quality cable ties. These tools are truly state-of-the-art both in design and performance.

BURNDY® tools make it easier for operators to install cable ties, while maintaining correct tension and flush cut-off. Worker safety is further enhanced as the tools can eliminate the sharp edges of a cut-off cable tie.



Catalog Number	Ref. Figure	Description	For Use On
CTTSS900	B	Stainless Steel Tie Tool	SS Ties up to 900 lbs

145PTAG

94V0 Rated Nylon Tag

Designed originally for the telecom market, this tag is applicable anywhere the need to mark tags in the field exists. Typically secured to cabling using a multi-ply cord or cable tie, or waxed cord. The tags may be written on in most inks or using a permanent marker. Durable, flame retardant, white nylon tag 94V0 rated.

Dimensions: 1" x 1-3/4"
Catalog Number: [145PTAG](#)

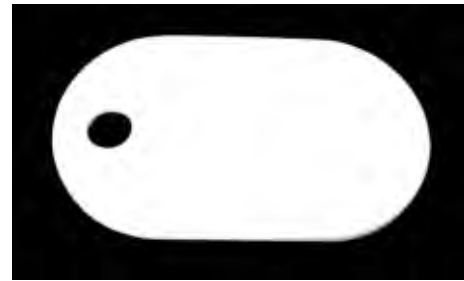

Table of Contents

Tap Connectors

Mechanical (Bolted)	H-3 - H-20
Compression	H-21 - H-40
Transformer and Equipment	H-41 - H-43



Compression Splices

Service Entrance	H-46 - H-48
Neutral	H-49
Jumper	H-50 - H-54
Repair Sleeve	H-55
Full Tension	H-56 - H-70



Deadend Fitting and Accessories

Loop	H-72 - H-73
Primary and Strain Bus	H-74 - H-75

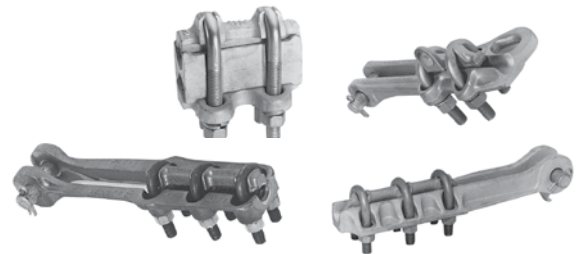

Compression Terminals and Accessories	H-77 - H-82
---	-------------

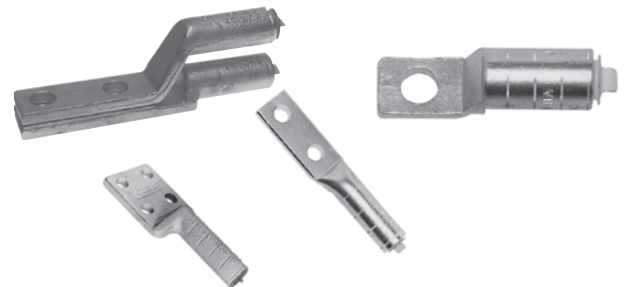

Most frequently ordered catalog numbers are highlighted in BLUE

Table of Contents

Tap Connectors

Mechanical (Bolted)	H-3 - H-20
Types KS, KS-3.....	H-4
Type SC.....	H-5
Type KSU.....	H-5
Type KVS.....	H-6
Type KVSW.....	H-6
Type KVSU.....	H-7
Type KVS-A.....	H-8
Type VG.....	H-9
Type UC-L.....	H-10
Type UCK-UL.....	H-10
Type CP-A.....	H-11
Type VP.....	H-12
Type UW-R.....	H-12
Type UC.....	H-13
Type CP.....	H-13
Type QPX.....	H-14
Type VT.....	H-15
Types UCG-R, UCG-RS.....	H-16
Types UC-R, UC-RS.....	H-16
Type UCT.....	H-17
Type UCT for Copper.....	H-18
Type UC--KIT.....	H-19
Type UC-COVER.....	H-19
Type UCTCOVER.....	H-19
Type LSC.....	H-20
Compression	H-21 - H-40
Compression Tap Connectors.....	H-21
Type YC-C.....	H-22
Type YP-C.....	H-22
Type YC-A.....	H-23
Type YP-U.....	H-24
Type YPC-U.....	H-25
Type YC-U.....	H-26
Types YPC-A-U, YPC-R-U.....	H-26
Type CC.....	H-27
Seven Connector Selector Chart	H-28
Types YHO, YHD.....	H-29
Types YHN, YHR.....	H-30
LOKTAP™.....	H-31
Type YCT.....	H-32
Type YOT.....	H-32
Type YTU-R-R.....	H-33
Type YTA-R-2N.....	H-34
Types YKA-R-2N, YKA-A-2N.....	H-35
Type YSA-R-2N.....	H-36
Type YTA-2N.....	H-36
Type YKA-R-2N.....	H-37
Type YCB-R.....	H-38
Types YCB-U, YCB-R-U.....	H-39
Types J990, J1252.....	H-39
Types YHO-J, YHD-J, YHN-J.....	H-40

Transformer and Equipment	H-41 - H-43
Type E-C-G.....	H-41
Types KC22J12T13, EQC632C.....	H-42
Type YA-2LH.....	H-42
Type YE-LH.....	H-43
Types YE-R, YE-W.....	H-43

Most frequently ordered catalog numbers are highlighted in BLUE

Mechanical (Bolted) Tap Connectors

The BURNDY line of mechanical tap connectors is the most complete, dependable and economical available. These mechanical connectors consist of service, parallel, and midspan types.

Generally the alloys and hardware used depend on whether the connector is for a strain or current carrying application, and is made of aluminum or copper. Particular alloys and hardware are selected for strength, conductivity, durability, ductility and resistance to corrosion.

In a copper connector, high strength alloys are used in mechanical clamping components and high conductivity alloy in current carrying elements.

Aluminum clamp type connectors are made of alloy 356, which is impervious to stress corrosion. In its heat-treated state, it has high strength and is used for both current carrying and clamping elements.

Hardware is high strength and corrosion-resistant. In copper connectors, DURIMUM™, a silicon bronze alloy, is used. Anodized aluminum alloy 2024-T4 bolts and 6061-T6 nuts are used in aluminum connectors. They provide the best combination of strength, resistance to galling and corrosion, and their thermal coefficient of expansion is most suitable for aluminum. To insure dependable connections, bolts should be tightened to the recommended torque values shown in the specific product table or in the table below.

These mechanical tap connectors are mainly used in overhead distribution systems to provide primary service taps and/or secondary service drop connections to the end users.

A few of the key features and benefits of these connectors are:

Features and Benefits

- High strength alloys provides efficient and reliable performance
- Range taking designs accommodate a large range of conductors in either groove; reducing inventory needs to a minimum
- Matched groove designs ensure maximum contact with conductors accommodated
- Hex bolts, nuts, and washers provide high contact pressure and rapid assembly

Recommended Tightening Torque		Standard Wrench Size	
Bolt Size	Recommended Torque (Inch Lbs.)	Bolt	Nut
DURIMUM™ Silicon Bronze and Galvanized Hardware			
1/4 - 20	80	7/16	7/16
5/16 - 18	180	1/2	1/2
3/8 - 16	240	9/16	9/16
1/2 - 13	480	3/4	3/4
5/8 - 11	660	15/16	15/16
3/4 - 10	1050	1-1/8	1-1/8
Aluminum Hardware*			
1/2 - 13	300	3/4	3/4
5/8 - 11	480	15/16	15/16
3/4 - 10	620	1-1/8	1-1/8

* Aluminum bolts are lubricated.

If no tightening torque is listed in the following catalog pages, use values in table above.

Torque Range	Recommended BURNDY® Torque Wrench
30 - 150 in-lbs	BTW30150
150 - 750 in-lbs	BTW150750



SERVIT® Types KS, KS-3

Split-bolt connectors for copper, copperweld

Material: Copper

Compact, high strength, high copper alloy SERVIT® split-bolt has free-running threads and easy to grip wrench flats. Highly resistant to season cracking and corrosion, the SERVIT® connectors provide maximum pressure and assure a secure connection on all combinations of run and tap conductors. Type KS-3 accommodates 3 maximum size conductors.

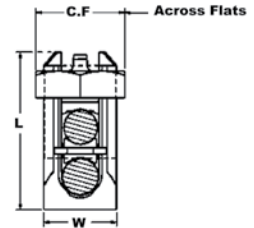

Catalog Number	L	W	Conductor						Recommended Tightening Torque(in-lb)	Wrench Size (across flats)
			Copper		Copperweld					
			Range for Equal Run and Tap	Min. Tap with Max. Run	Maximum Run and Tap					
					Sol.	Str.	Type A	Type D		
† KS90	0.85	0.38	12 Str. - 10 Str.	16 Str.	#10	—	—	—	80	1/2
† KS15	0.85	0.38	10 Str. - 8 Str.	14 Str.	#8	—	—	—		
† KS17	1.14	0.45	8 Str. - 6 Sol.	14 Str.	#6	3 #12	8A	9-1/2D	165	5/8
* KS173	0.98	0.70	8 Str. - 6 Sol.	16 Str.	#6	3 #12	8A	9-1/2D		
† KS20	1.20	0.51	8 Str. - 4 Sol.	14 Str.	#4	3 #10	6A	8D		11/16
* KS203	1.17	0.78	8 Str. - 4 Sol.	14 Str.	#4	3 #10	6A	8D		
† KS22	1.50	0.60	6 Str. - 2 Sol.	14 Str.	#2	3 #8	4A	6D	275	3/4
* KS223	1.33	0.84	6 Str. - 2 Sol.	14 Str.	#2	3 #8	4A	6D		
† KS23	1.54	0.62	6 Str. - 2 Str.	14 Str.	#1	3 #7	3A	5D		7/8
† KS25	1.77	0.73	4 Str. - 1/0 Str.	14 Str.	2/0	3 #5	2A	4D		
† KS26	1.94	0.82	2 Str. - 2/0 Str.	14 Str.	3/0	7 #7	—	—	385	1-1/16
† KS27	1.86	1.17	1 Str. - 3/0 Str.	8 Sol.	—	—	—	—		500
† KS29	2.07	1.17	1 Str. - 250	8 Str.	4/0	7 #5	—	—	650	1-7/16
† KS31	2.51	1.41	1/0 Str. - 350	1/0 Str.	—	19 #8	—	—		825
† KS34	2.79	1.48	2/0 Str. - 500	2/0 Str.	—	19 #6	—	—	1000	2-3/16
KS39	3.29	1.94	4/0 Str. - 750	4/0 Str.	—	19 #5	—	—	1100	2-3/8
KS44	3.73	2.19	300 - 1000	4/0 Str.	—	—	—	—	1100	2-9/16

▲ Listed torque values are for maximum conductor combinations accommodated. Consult UL486 Tables 7-4, 7-5, 7-6 for smaller conductor combinations.

See note page A-2

* Not UL Listed or CSA Certified.

† In addition to UL Listed for wire connectors and CSA Certified, these items are also UL rated for direct burial.

To ensure proper tightening torque use BURNDY® BTW Torque Wrenches.

SERVIT® Cover Type SC

Split-bolt SERVIT® Connector Cover

Material: Plastic



Used indoors or outdoors this compact, one-piece plastic SERVIT® cover, saves time and material, eliminates costly taping of split-bolts. Positive latch snaps easily and quickly over connector, ideal for tight quarters. Self positioning plastic fingers wrap around wires fully insulating joint. UL Listed for 600 volt indoor application. Three covers accommodate a range of 6 SERVIT® sizes through 2/0 Stranded.

Catalog Number	Conductor Range				*For Use with	For Use with
	Range for Equal Run/Tap		Min. Tap/Max. Run			
	Min.	Max.	Min.	Max.		
SC4	8 Str.	6 Sol.	14 Str.	6 Sol.	KS17	—
SC4	8 Str.	4 Sol.	14 Str.	4 Sol.	KS20	—
SC2	6 Str.	2 Sol.	14 Str.	2 Sol.	KS22	KSA6
SC2	6 Str.	2 Str.	14 Str.	2 Str.	KS23	KSA4
SC2/0	4 Str.	1/0 Str.	14 Str.	1/0 Str.	KS25	KSA2
SC2/0	2 Str.	2/0 Str.	14 Str.	2/0 Str.	KS26	KSA1/0

* UL Listing of Type SC Cover applies to use on BURNDY® SERVIT® Type KS and equivalent split-bolt connectors, when indicated strip length is maintained, maximum indicated conductor sizes are not exceeded, and connector is properly located within recess provided for it.

Universal SERVIT® Type KSU

Split-bolt connectors for copper, copperweld, AAC, ACSR, AAAC, Steel

Material: Copper (Tin Plated)

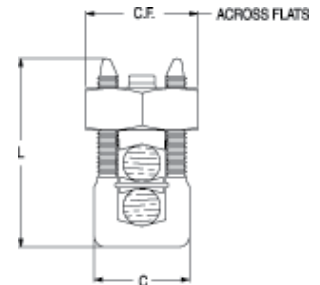

Tin-plated, high strength copper alloy SERVIT® connector with spacer. Spacer separates dissimilar conductors and provides long contact length that prevents high pressure point contacts between run and tap conductors. Use of PENETROX™ joint compound recommended with Aluminum and ACSR to limit oxide growth and increase life of connection. To ensure proper tightening torque use of BURNDY® Torque Wrenches Type BTW is recommended.

Catalog Number	L	C	Run		Tap		Max. Conductor			Recommended Tightening Torque in-lb	Wrench Size (across Flats)	
			Copper & Aluminum	ACSR / AAAC / 5005	Copper & Aluminum	ACSR / AAAC / 5005	Steel					
							Sol. 3 Str.	Nom. BWG	BWG Dia.			
KSU17	0.92	0.42	12 Sol. - 6 Sol.	8 (6-1)	12 Sol. - 6 Sol.	8 (6-1)	8	—	5/32	165	5/8	
KSU20	1.05	0.48	10 Sol. - 4 Sol.	6 (6-1)	10 Sol. - 4 Sol.	6 (6-1)	6	8	7/32		11/16	
KSU22	1.25	0.57	10 Sol. - 2 Sol.	6 (6-1) - 4 (7-1)	10 Sol. - 2 Sol.	6 (6-1) - 4 (7-1)	4	6	1/4	275	3/4	
KSU23	1.48	0.59	8 Str. - 2 Str.	3 (6-1) - 2 (6-1)	8 Sol. - 2 Str.	6 (6-1) - 2 (6-1)	—	4	5/16		13/16	
KSU25	1.77	0.70	2 Str. - 1/0 Str.	3 (6-1) - 1 (6-1)	10 Str. - 1/0 Str.	6 (6-1) - 1 (6-1)	—	—	—	3/8	385	15/16
KSU26	1.93	0.79	2 Str. - 2/0 Str.	1 (6-1) - 1/0 (6-1)	8 Str. - 2/0 Str.	6 (6-1) - 1/0 (6-1)				7/16		1-1/16
KSU27	2.34	1.12	1 Str. - 3/0 Str.	1 (6-1) - 2/0 (6-1)	8 Sol. - 3/0 Str.	8 (6-1) - 2/0 (6-1)				1/2	500	1-3/8
KSU29	2.50	1.58	1 Str. - 250	2/0 (6-1) - 4/0 (6-1)	8 Str. - 250	6 (6-1) - 4/0 (6-1)	5/8	5/8	650	1-11/16		
KSU31	2.88	1.36	1/0 Str. - 350	3/0 (6-1) - 4/0 (6-1)	4 Str. - 350	4 (6-1) - 4/0 (6-1)						
KSU34	3.12	1.47	400 - 500	336 (30-7) - 477 (18-1)	2 Str. - 500	2 (6-1) - 477 (18-1)	—	—	825	1-13/16		

Overhead Distribution

Mechanical Tap Connectors
OKLIP™ Type KVS, Type KVSW

OKLIP™ Type KVS

Connector for Copper, Copperweld

Material: Copper



Compact, two-piece, high strength, high copper alloy OKLIP™ connector recommended for heavy duty connections. Neoprene rings hold bolts in place during installation. Installed with ordinary wrench.

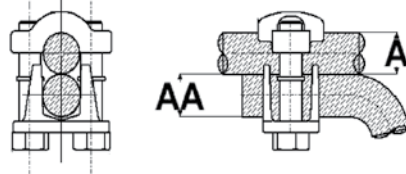

Catalog Number	Conductor					Recommended Tightening Torque (in-lb)	Wrench Size (Cross flats)
	Copper		Copperweld				
	Run (A)	Tap (AA)	Max. Run & Tap				
		Sol.	Str.	Type V			
KVS26	1 Str. - 2/0 Str.	6 Str. - 2/0 Str.	3/0	7 #8	—	180	1/2
KVS28	1/0 Str. - 4/0 Str.	10 Str. - 4/0 Str.	4/0	7 #6	V3/0	250	9/16
KVS31	250 - 350 kcmil	10 Str. - 350 kcmil	—	19 #8	V250	325	3/4
KVS34	400 - 500 kcmil	10 Str. - 500 kcmil	—	19 #6	V350	375	3/4
KVS40	400 - 800 kcmil	3/0 Str. - 800 kcmil	—	19 #5	—	500	3/4
KVS44	500 - 1000 kcmil	3/0 Str. - 1000 kcmil	—	—	—	500	15/16

To ensure proper tightening torque use BURNDY® BTW Torque Wrenches.

OKLIP™ Type KVSW

Connector for Copper, Copperweld

Material: Copper

Similar to OKLIP™ Type KVS except for high copper alloy spacer that separates run and tap conductor. Provides high contact pressure, confines conductor strands, and assures vibration proof connection. Longer peened bolt permits swivel action for easier installation.



Catalog Number	Conductor		Wrench Size (Cross Flats)	Torque in - lb
	Run	Tap		
KVSW26	2 Str. - 2/0 Str.	6 Sol. - 2/0 Str.	1/2	180
KVSW28	1/0 Str. - 4/0 Str.	6 Sol. - 4/0 Str.	9/16	250
KVSW31	250 - 350 kcmil	4 Sol. - 350 kcmil	3/4	325
KVSW34	400 - 500 kcmil	4 Str. - 500 kcmil	3/4	375
KVSW40	400 - 800 kcmil	4/0 - 800 kcmil	3/4	500
KVSW44	500 - 1000 kcmil	250 - 1000 kcmil	15/16	500

To ensure proper tightening torque use BURNDY® BTW Torque Wrenches.

Universal OKLIP™ Type KVSU

Connector for Copper, Copperweld, AAC†, AAAC†

Material: Copper (Tin Plated)

Compact, high strength, tin-plated copper alloy two-piece connector with spacer and tin-plated silicon bronze DURIMUM™ hardware. Recommended for heavy duty connections. Spacer separates dissimilar conductors and provides long contact length. Neoprene ring prevents loss of shorter bolt during installation. Longer peened bolt permits swivel action for easier installation. Use of PENETROX™ joint compound is recommended with aluminum and ACSR conductor.

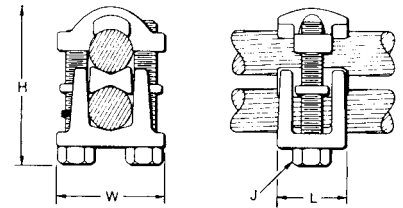

Catalog Number	Conductor								H	J	L	W	Rec. Tightening Torque (in-lb)	Wrench Size (Cross Flats)
	Run		Tap		Run		Tap							
	Copper & Alum.	ACSR, AAAC, & 5005	Copper & Alum.	ACSR, AAAC, & 5005	Copper Sol., Copperweld Sol.	Steel Nom. Dia.	Copper Sol., Copperweld Sol.	Steel Nom. Dia.						
KVSU26	2 Str. - 2/0 Str.	3 - 2/0	6 Str. - 2/0 Str.	6 - 2/0	1 - 3/0	5/16 - 7/16	#6 - 3/0	3/16 - 7/16	2	5/16	1	1-1/2	180	1/2
KVSU28	1/0 Str. - 4/0 Str.	1/0 - 4/0	6 Str. - 4/0 Str.	6 - 4/0	2/0 - 4/0	3/8 - 1/2	#6 - 4/0	5/32 - 1/2	2-3/8	3/8	1-1/8	1-3/4	250	9/16
KVSU31	250 - 350 kcmil	4/0 - 300	#5 - 350	6 - 300	—	9/16 - 5/8	#6 - 4/0	3/16 - 5/8	2-5/8	1/2	1-3/8	2-1/8	325	3/4
KVSU34	400 - 500 kcmil	336.4 - 397.5	#4 - 500	5 - 397.5	—	3/4 - 3/4	#4 - 4/0	7/32 - 3/4	3	1/2	1-1/2	2-1/4	375	3/4
KVSU40	400 - 800 kcmil	336.4 - 715.5	4/0 - 800	3/0 - 715.5	—	3/4 - 1	—	1/2 - 1	3-1/2	1/2	1-5/8	2-1/2	500	3/4
KVSU44	500 - 1000 kcmil	397.5 - 900	4/0 - 1000 kcmil	4/0 - 900	—	7/8 - 1-1/8	—	1/2 - 1-1/8	4	3/8	2	3	500	5/16

† Accommodates compressed conductors within diameter range.
 To ensure proper tightening torque use BURNDY® BTW Torque Wrenches.

OKLIP™ Type KVS-A

Connector for Copper, Copperweld, AAC†, ACSR†, AAAC

Material: Aluminum

Three-piece, high-conductivity, non-copper bearing aluminum alloy connector with thick spacer and aluminum hardware. Hardware in KVS26A and KVS28A is stainless steel. Recommended for heavy duty dissimilar metal applications. Spacer separates conductors and provides long contact length. Belted entrances prevent chafing and permit easier assembly of conductors. Longer, peened bolt, permits swivel action for easier installation. Neoprene ring prevents loss of shorter bolt. PENETROX™ joint compound recommended with aluminum and ACSR.

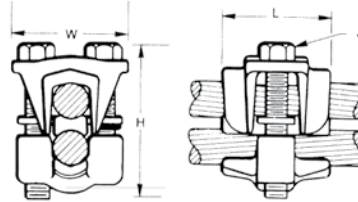

Catalog Number	Conductor			
	Run		Tap	
	Copper & Aluminum†	ACSR†, AAAC, & 5005	Copper & Aluminum†	ACSR†, AAAC, & 5005
KVS26A	2 Str. - 2/0 Str.	#4 - 2/0	10 Str. - 2/0 Str.	#6 - 2/0
KVS28A	1/0 Str. - 4/0 Str.	1/0 - 4/0	10 Str. - 4/0 Str.	#6 - 4/0
KVS31A	250 - 350	4/0 - 336.4	6 Str. - 350 kcmil	#6 - 336.4 kcmil
KVS34A	400 - 500	336.4 - 397.5	4 Str. - 500 kcmil	#5 - 397.5 kcmil
KVS40A	400 - 800	336.4 - 715.5 kcmil	3/0 Str. - 800 kcmil	3/0 - 715.5
KVS44A	500 - 1000	397.5 - 900 kcmil	3/0 Str. - 1000 kcmil	3/0 - 900 kcmil

† Accommodates compressed conductors within diameter range.
To ensure proper tightening torque use BURNDY® BTW Torque Wrenches.

THESE CONNECTORS CAN ACCOMMODATE ACSR CONDUCTORS OVER ARMOR ROD WITHIN THE DIAMETER RANGE INDICATED.

Application Over Armor Rod

Catalog Number	Conductor Range by Diameter			H	J	L	W
	Min. Run Dia.	Min. Tap Dia.	Max Run & Tap Dia.				
KVS26A	0.28	0.11	0.44	2	5/16	1-3/8	1-5/8
KVS28A	0.36	0.11	0.56	2-3/8	3/8	1-5/8	2
KVS31A	0.56	0.18	0.68	3	1/2	2	2-5/8
KVS34A	0.72	0.21	0.81	3-3/8	1/2	2-1/2	2-5/8
KVS40A	0.72	0.47	1.03	4	1/2	3-1/8	3
KVS44A	0.80	0.47	1.16	4-1/2	5/8	3-1/2	3-3/8

VISEIT™ Type VG Connector for Copper

Material: Copper

Copper VISEIT™ connectors are easy to install and will not swivel. The interlocking parts will not rotate out of the body. Supplied with hex head bolts; VG1 size has a slotted hex bolt.



Features and Benefits

- Single tool installation keeps other hand free to contain conductors
- Compact profile after installation facilitates taping and alignment with conductors
- Accommodates a wide range of conductors and minimizes number of connectors required
- Side installation of conductors eliminates having to separate pieces during installation
- Copper alloy body design provides combination of strength and corrosion resistance

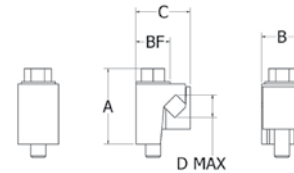

Catalog Number	Conductor Range ①		A	B	C	Bolt Head (Hex.)	Recommended Torque (In-Lb)
	Max. 2 Conductor	Min. 2 Conductor					
VG1 ②	6 Sol.	10 Sol.	0.94"	0.63"	0.75"	3/8" (Slotted)	110 lbs/in
VG2	4 Str.	8 Str.	1.09"	0.70"	0.81"	9/16"	110 lbs/in
VG3	2 Sol.	6 Sol.	0.98"	0.83"	0.94"	9/16"	150 lbs/in
VG4	1/0 Str.	4 Sol.	1.70"	1.00"	1.33"	9/16"	180 lbs/in
VG5	2/0 Str.	3 Sol.	1.80"	0.98"	1.28"	9/16"	180 lbs/in

① Connectors are capable of accepting any combination of conductors of conductors within specified maximum range (example: VG1 can accept 7 Sol. - 9 Str. combination)

② The VG1 hardware has a slotted hex. The other sizes are unslotted. Hardware is stainless steel.

Universal Parallel Groove Clamp, Type UC-L For Copper, Copperweld, AAC†, ACSR†, AAAC, Steel

Material: Copper (Tin Plated)

Interlocking finger design accommodates large range of conductor sizes. Tin-plated, cast of high copper alloy, and clamped with plated steel bolt. PENETROX™ joint compound recommended with aluminum and ACSR.

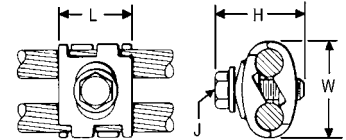
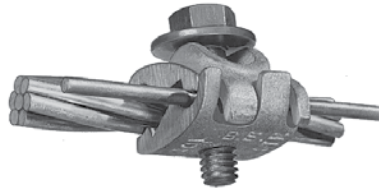

Catalog Number	Copper & Alum. (Either Groove)	ACSR†, 6201, 5005	Copperweld	Steel		Dimensions				Wrench (Cross flats)	Torque in - lb
				Nom. Dia.	AWG	L	H	J	W		
UC8W26L	8 Sol. - 2/0 Str.	6 - 1/0	8 Sol. - 7 #7	5/32 - 7/16	8 Sol. - 4-3 Str.	1	1-1/2	5/16	1-7/16	1/2	180
UC2W28L	2 Sol. - 4/0 Str.	3 - 4/0	3 #8 - 7 #6	9/32 - 9/16	4 - 3 Str. - 4 - 3 Str.	1-1/8	1-1/2	3/8	1-3/4	9/16	250

† Accommodates compact and compressed conductors within diameter range. To ensure proper tightening torque use BURNDY® BTW Torque Wrenches. Torque values are for max. conductor sizes.

Universal Parallel Groove Clamp, Type UCK-UL For Copper, Copperweld, AAC, ACSR, AAAC, Steel

Material: Copper (Tin Plated)



Interlocking finger design accommodates large range of conductor sizes. Tin-plated, cast of high copper alloy, and clamped with silicon bronze DURIMUM™ bolt. PENETROX™ joint compound recommended with ACSR. Applications include grounding for the Cable TV industry.

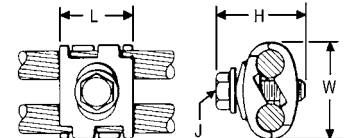

Catalog Number	For Use With:	Conductor Range				Dimensions				Wrench Size (Cross flats)	Torque in - lb
		Groove A		Groove B		L	H	J	W		
		Maximum Size	Minimum Size	Maximum Size	Minimum Size						
UCK1UL †	Aluminum or Galvanized Steel Strand to Copper or Copper Bonded Steel Wire	1/0 ACSR 7/16 Galvanized Steel Strand	#6 ACSR	2/0 Str. Copper 7/16 Copperweld, 2A Copperweld	#8 Sol. Copper 9-1/2D Copperweld	1	1-7/16	5/16	1-7/16	1/2	180
UCK2UL	Aluminum or Galvanized Steel Strand to Aluminum or Galvanized Steel Strand	1/0 ACSR 7/16 Galvanized Steel Strand	#6 ACSR	1/0 ACSR or 7/16 Galvanized Steel Strand	#6 ACSR					1/2	180
UCK3UL	Copper to Copper	2/0 Str. Copper 7/16 Copperweld 2A Copperweld	#8 Sol. Copper 9-1/2D Copperweld	2/0 Str. Copper 7/16 Copperweld 2A Copperweld	#8 Sol. Copper 9-1/2D Copperweld					1/2	180

† Accommodates compact and compressed conductors within diameter range. To ensure proper tightening torque use BURNDY® BTW Torque Wrenches. Torque values are for max. conductor sizes.

Parallel Groove Clamp, Type CP-A
For Copper, Copperweld, AAC†, ACSR, AAAC, Steel

Material: Aluminum (Cast), Aluminum Hardware

Type CP-A Parallel Groove Clamps are recommended for tap or parallel connections. High strength, high conductivity aluminum body and hardware provide corrosion resistant assembly. Long contact surface for excellent contact and full conductivity. PENETROX™ joint compound recommended for all combinations.

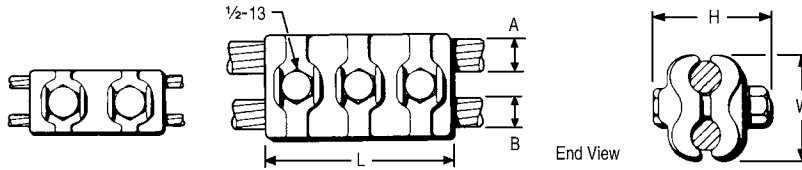

Fig. 1

Fig. 2

Catalog Number	Groove A		Groove B		Fig. No.	Dimensions			Wrench Size (cross flats)	Torque in - lb
	ACSR, 6201, 5005	Copper & Aluminum	ACSR, 6201, 5005	Copper & Aluminum		L	H	W		
CP26A26A	1/0	3/0 Sol. - 2/0 Str.	1/0	3/0 Sol. - 2/0 Str.	1	4"	2-7/8"	2.13	3/4	480
CP27A27A	2/0 101.8 (12-7) 110.8 (12-7)	4/0 Sol. - 3/0 Str.	2/0 101.8 (12-7) 110.8 (12-7)	4/0 Sol. - 3/0 Str.						480
CP28A28A	3/0 134.6 (12-7)	4/0 Str.	3/0 134.6 (12-7)	4/0 Str.						480
CP29A29A	4/0 159 (12-7) 203 (8-7)	250 266.8	4/0 159 (12-7) 203 (8-7)	250 266.8						480
CP30A30A	176.9 (12-7) 190.8 (12-7) 266.8 (18-1, 6-7, 26-7)	300	176.9 (12-7) 190.8 (12-7) 266.8 (18-1, 6-7, 26-7)	300	2	4-1/2"	2.38	3/4	480	
CP31A31A	211.3 (12-7) 300 (26-7, 30-7) 336.4 (18-1)	336.4 350	211.3 (12-7) 300 (26-7, 30-7) 336.4 (18-1)	336.4 350					480	
CP32A32A	203.2 (16-19) 336.4 (26-7, 30-7) 397.5 (18-1)	397.5 400	203.2 (16-19) 336.4 (26-7, 30-7) 397.5 (18-1)	397.5 400					480	
CP34A34A	397.5 (26-7, 30-7) 477 (18-1)	450 477 500	397.5 (26-7, 30-7) 477 (18-1)	450 477 500	5"	3"	2.50		480	
CP37A37A	500 (30-7) 556.5 (24-7, 26-7, 30-7) 636 (36-1) 605 (24-7)	636	500 (30-7) 556.5 (24-7, 26-7, 30-7) 636 (36-1) 605 (24-7)	636	5-1/4"	3-3/8"	3.00		480	

† Accommodates compact and compressed conductors within diameter range. For other sizes contact factory.
Not recommended for copper to copper applications. Use copper connector.
To ensure proper tightening torque use BURNDY® BTW Torque Wrenches.

Parallel Groove Clamp, Type VP For Copper

Material: Copper

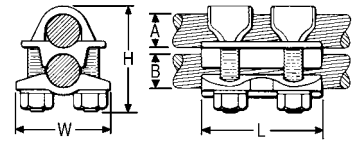

Multiple V-bolt connector especially suited for flexible or extra flexible conductors. Made of high strength, high conductivity copper. Clamping elements accommodate a range of conductor sizes in either groove. V-bolts provide high pressure and compress the conductor over long contact area. Also recommended for jumper connections.

Catalog Number	Groove A	Groove B	Dimensions			Wrench Size (Cross flats)	Torque in - lb
			L	H	W		
VP2828	1/0 Str. - 4/0 Str.	1/0 Str. - 4/0 Str.	2-3/4"	2-1/8"	1.75"	9/16	250
VP3030	1/0 Str. - 300	1/0 Str. - 300	3-1/8"	2-1/2"	2.00"	11/16	325
VP3430	300 - 500		3-1/4"	3-1/8"	2.50"	3/4	375
VP3434		300 - 500	3-1/2"	4-3/8"	2.88"	7/8	500
VP4030	500 - 800	1/0 Str. - 300	3-7/8"	5"	3.19"		
VP4440	750 - 1000	500 - 800	4-1/2"	5-3/8"	3.50"	15/16	600
VP4646	1000 - 1500	1000 - 1500					

To ensure proper tightening torque use BURNDY® BTW Torque Wrenches.

CLIPIT™ Dead End Clamp, Type UW-R For AAC†, ACSR†, AAAC

Material: Aluminum (Cast)

High strength aluminum casting with galvanized steel U-bolt, extra long aluminum spacer, and caps that confine strands. Holding strength of installations using two CLIPIT™ deadends exceeds rated breaking strength of conductor. Use of PENETROX™ joint compound is recommended.

RUS Accepted

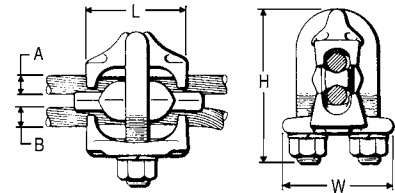

Catalog Number	Run A		Tap B		Dimensions			Wrench	Torque in - lb
	ACSR, 6201, 5005	Aluminum	ACSR, 6201, 5005	Aluminum	L	H	W		
UW2R	6 - 2	6 Str. - 2 Str.	6 - 2	6 Str. - 2 Str.	1-1/2"	2-5/8"	1.82"	9/16	240
UW25R	6 - 1/0	6 Str. - 2/0 Str.	6 - 1/0	6 Str. - 2/0 Str.	1-7/8"	2-7/8"	1.98"		240

† Accommodates compact and compressed conductors within diameter range. To ensure proper tightening torque use BURNDY® BTW Torque Wrenches.

Parallel Groove Clamp, Type UC For Copper

Material: Copper

Type UC connector accommodates large range of conductors in either groove, reducing inventory to a minimum. Interlocking finger design provides firm grip with maximum contact length. High strength, corrosion resistant silicon bronze hardware. One wrench installation.

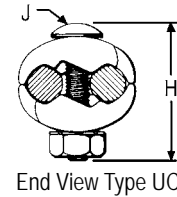

Fig. 1

Catalog Number	Conductor (Either Groove)	Fig.	Dimensions				Wrench Size (Cross flats)	Torque in - lb
			L	H	J	W		
UC6W25	6 Sol. - 1/0 Str.	1	1-3/4"	1-5/8"	3/8"	1-3/8"	9/16	240
UC4W28	4 Sol. - 4/0 Str.	2	2-1/8"	2"		1-3/4"		240
UC2W30	2 Sol. - 300			2-3/8"	2-1/8"	2"		240
UC2834	4/0 Str. - 500	3	4-1/4"	2-7/8"	1/2"	2-1/2"	3/4	480
UC3040	300 - 800			3-3/8"		3"		480
UC3444	500 - 1000			3-5/8"		3-1/2"		480

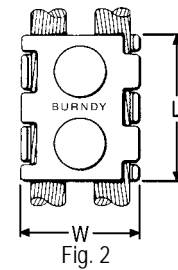

Fig. 2

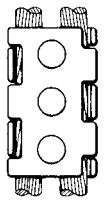

Fig. 3

To ensure proper tightening torque use BURNDY® BTW Torque Wrenches

Parallel Groove Clamp, Type CP For Copper

Material: Copper

High strength, high copper alloy Type CP clamps are recommended for heavy duty parallel connections. Silicon bronze DURIMUM™ hardware and cast copper body provides corrosion resistant assembly. Long contact surface provides excellent and assures full conductivity.



Fig. 1

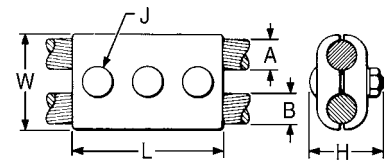

Fig. 2

Catalog Number	Groove		Fig.	Dimensions			Wrench Size (Cross flats)	Torque in - lb
	A	B		L	J	W		
CP2C2C	2 Str.	2 Str.	1	2-1/2"	3/8"	1-1/4"	9/16	240
CP2525	1/0 Str.	1/0 Str.		3"		1-5/8"		240
CP2626	2/0 Str.	2/0 Str.						240
CP2828	4/0 Str.	4/0 Str.	2	4"	1/2"	2"	3/4	240
CP2929	250	250						240
CP3434	500	500		5"		2-1/2"		480

For other sizes contact factory.

To ensure proper tightening torque use BURNDY® BTW Torque Wrenches

VERSITAP™ Connector, Type QPX For Copper, Copperweld

Material: Copper

The VERSITAP™ Type QPX connector is recommended for Tee, Cross, Parallel, Butt, and Tap connections. Range-taking, only requires 10 connectors to accommodate conductor sizes from #6 Stranded to 1000 kcmil. Edges are rounded for easy taping. Made of high strength, high conductivity copper alloy and supplied with silicon bronze DURIMUM™ hardware.

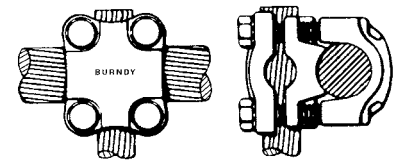
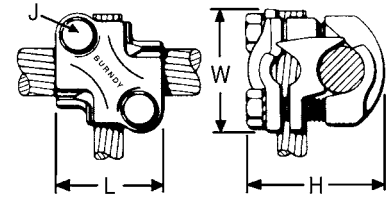

PARALLEL

TAP

TEE

CROSS

BUTT

Catalog Number	Run			Tap			Dimensions				Wrench Size (Cross Flats)	Torque in - lb
	Copper Str - RUN	Copperweld Solid - RUN	Copperweld Str - RUN	Copper Str - TAP	Copperweld Solid - TAP	Copperweld Str - TAP	L	H	J	W		
QPX2C2C	6 Str. - 2 Str.	5 Sol. - 3 #7	8A - 4A	6 Str. - 2 Str.	5 Sol. - 3 #7	8A - 4A	1-3/8	1.50	5/16	1-3/8	1/2	150
QPX282C	1 Str. - 4/0 Str.	7 #9 - 7 #5	3A - 3/0V	6 Str. - 2 Str.	5 Sol. - 3 #7	8A - 4A		2.06		1-9/16		250
QPX2828				1 Str. - 4/0 Str.	7 #9 - 7 #5	3A - 3/0V	1-7/8	2.38	3/8	1-13/16	9/16	250
QPX342C	250 - 500 kcmil	19 #19 - 19 #6	4/0 EK	6 Str. - 2 Str.	5 Sol. - 3 #7	8A - 4A	1-3/8	2.50	5/16	1-7/8	1/2	250
QPX3428				1 Str. - 4/0 Str.	7 #9 - 7 #5	3A - 3/0V	1-3/4	2.75		3/8		2-1/16
QPX3434				250 - 500 kcmil	19 #19 - 19 #6	4/0 EK	2	3.00	2-3/16		250	
QPX442C	500 - 1000 kcmil	19 #6	—	6 Str. - 2 Str.	5 Sol. - 3 #7	8A - 4A	1-3/8	2.63	5/16	2-1/4	1/2	250
QPX4428			—	1 Str. - 4/0 Str.	7 #9 - 7 #5	3A - 3/0V	1-7/8	2.88		3/8		2-7/16
QPX4434			—	250 - 500 kcmil	19 #19 - 19 #6	4/0 EK	2	3.06	2-9/16		250	
QPX4444			—	500 - 1000 kcmil	19 #6	—	2-5/8	3.44		250		

To ensure proper tightening torque use BURNDY® BTW Torque Wrenches

T-Connector, Type VT
V-bolt clamping for Copper

Material: Copper



High copper alloy T-connector for cable run, cable tap. V-bolt clamping elements accommodate a large range of cable and are particularly suited for extra flexible cable. One-wrench installation.

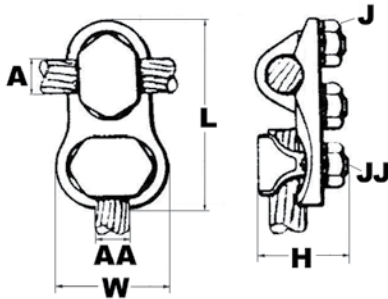

Catalog Number	Conductor		H	L	W	Torque Ratings			
	Run (A)	Tap (AA)				Wrench 1	Wrench 2	Torque 1	Torque 2
VT2C2C	8 AWG - 2 AWG	8 AWG - 2 AWG	1-3/8"	2-3/8"	1"	7/8	7/8	275	275
VT2525	6 AWG - 1/0	6 AWG - 1/0 1/0 - 4/0 AWG	1-5/8"	2-5/8"	1-1/4"	1	1	385	385
VT2825	1/0 - 4/0 AWG			3-1/8"	1-1/4"	9/16	1	250	385
VT2828				3-3/8"	1-3/4"	9/16	9/16	250	250
VT3025	1/0 - 300 kcmil	6 AWG - 1/0	1-7/8"	3-3/8"	1-1/8"	11/16	1	325	385
VT3030		1/0 - 300 kcmil		3-1/2"	2"	11/16	11/16	325	325
VT3425	300 kcmil - 500 kcmil	6 AWG - 1/0	2-3/8"	3-5/8"	1-1/4"	3/4	1	375	385
VT3428		1/0 - 4/0 AWG		3-1/2"	1-3/4"	9/16	3/4	250	250
VT3430		1/0 - 300 kcmil		3-5/8"	2"	3/4	1	480	385
VT3434		300 kcmil - 500 kcmil		3-3/4"	2-1/4"	3/4	3/4	480	480
VT4040	500 kcmil - 800 kcmil	500 kcmil - 800 kcmil	2-5/8"	4-3/8"	2-5/8"	7/8	7/8	600	600
VT4425	750 kcmil - 1000 kcmil	6 AWG - 1/0	2-7/8"	4-3/4"	1-1/4"	15/16	1	660	385
VT4428		1/0 - 4/0 AWG		4-1/8"	1-3/4"	15/16	9/16	660	240
VT4834	1500 kcmil - 2000 kcmil	300 kcmil - 500 kcmil	4-1/4"	5-1/4"	2-1/4"	1-1/8	3/4	1050	480

To ensure proper tightening torque use BURNDY® BTW Torque Wrenches

TAPIT™ Parallel Clamp, Types UCG-R, UCG-RS For Copper, AAC†, ACSR†, AAAC

Material: Aluminum

Multi-purpose parallel groove clamp made of high strength, high conductivity, non-copper bearing aluminum alloy. Properly proportioned to minimize stress corrosion and deterioration by galvanic action.

Interlocking fingers on connect body halves prevent mismatching. Square shank, hex head, round collar, high strength galvanized steel bolt allows one or two-wrench installation. Available pre-filled with PENETROX™ joint compound, and stripsealed to limit oxide growth and to increase the life of the connection.

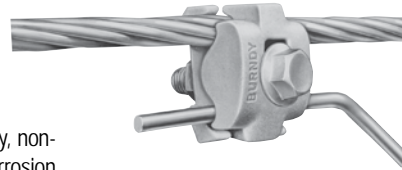

RUS Accepted

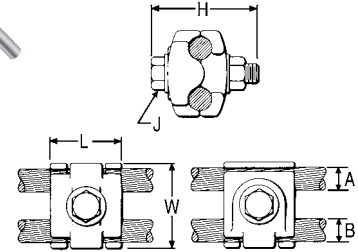

Catalog Number		Groove A		Groove B		Dimensions				Wrench Size	Torque In-lb
With Stripseal	Without Stripseal	Copper & Aluminum†	ACSR†, 6201, & 5005	Copper & Aluminum†	ACSR†, 6201, & 5005	L	H	J	W		
UCG25R2RS**	UCG25R2R**	6 Sol. - 1/0 Str.	8 Str. - 1/0 Str.	6 Sol. - 2 Str.	8 - 2	1-1/8"	1-7/8"	5/16"	1-3/8"	1/2	180
UCG25RS	UCG25R	8 Str. - 1/0 Str.	6 - 1/0	8 Str. - 1/0 Str.*	6 - 1/0	1-3/8"	2-1/8"	3/8"	1-5/8"	9/16	240
UCG28RS	UCG28R	1/0 Str. - 4/0 Str.	1/0 - 4/0	1/0 Str. - 4/0 Str.	6 - 4/0	1-3/8"	2-1/5"	3/8"	1"	3/4	480
UCG32RS	UCG32R	1/0 Str. - 397.5	1/0 - 336.4	8 Str. - 2/0 Str.	6 - 1/0	1-1/2"	2-5/8"	3/8"	2-1/8"	9/16	240

* Maximum recommended combinations: 1/0 Aluminum or ACSR Run - #2 Str. Copper Tap; 1/0 Copper Run - 1/0 Aluminum or ACSR Tap.

† Accommodates compact and compressed conductors within diameter range.

** Supplied with galvanized steel, square shank bolt.

Not recommended for copper to copper applications. Use a copper connector to increase connection life. For proper installations use BURNDY® BTW Torque Wrenches.

TAPIT™ Parallel Clamp, Types UC-R, UC-RS For Copper, AAC†, ACSR†, AAAC

Material: Aluminum

High strength, high conductivity, non-copper bearing aluminum alloy, properly proportioned to minimize stress corrosion and deterioration by galvanic action. Keying tabs on connector body halves prevent mismatching. Square shank, high strength galvanized steel bolt allows one wrench installation. Available pre-filled with PENETROX™ joint compound and stripsealed.



RUS Accepted

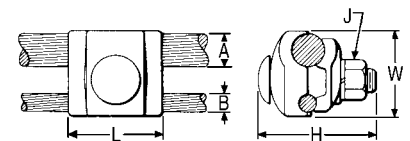

Catalog Number		Groove A		Groove B		Dimensions				Wrench	Torque
With Stripseal	Without Stripseal	Copper & Aluminum†	ACSR†, 6201, & 5005	Copper & Aluminum†	ACSR†, 6201, & 5005	L	H	J	W		
UC25R2RS	UC25R2R	8 Sol. - 1/0 Str.	6 - 1/0	8 Sol. - 2 Str.	6 - 2	1-1/8"	1-5/8"	5/16"	1-3/8"	1/2	180
UC28RS	UC28R	1/0 Str. - 4/0 Str.	1/0 - 4/0	8 Sol. - 1/0 Str.	6 - 1/0	1-3/8"	2-3/8"	3/8"	1-7/8"	9/16	240
UC32RS	UC32R	1/0 Str. - 397.5	336.4	6 Sol. - 2/0 Str.	6 - 1/0	1-1/2"	2-3/8"	3/8"	2-1/4"	9/16	240
—	UC33R	4/0 Str. - 400	336.4	6 Sol. - 2/0 Str.	6 - 2/0	1-3/4"	2-3/4"	1/2"	2-1/4"	3/4	480

* Maximum recommended combinations: 4/0 Aluminum or ACSR Run - #2 Str. Copper Tap.

† Accommodates compact and compressed conductors within diameter range.

Not recommended for copper to copper applications. Use a copper connector to increase connection life. For proper installations use BURNDY® BTW Torque Wrenches.

FASTAP™ with Lineman Assist™, Type UCT For Copper, AAC, ACSR, AAAC, ACAR, Messenger Guy

Material: Aluminum (Galvanized Steel Hardware)

The BURNDY® FASTAP™ with Lineman Assist™ mechanical connector utilizes a spring system that acts as a third hand to assist in installation. This system helps secure the tap conductor while installing on Primary, Secondary, and service applications. The duck bill handle simplifies installation by providing a handle to easily hold the connector while wearing dielectric gloves. Conductor side entry facilitates installation and also helps keep inhibitor in the connector. Supplied strip sealed and pre-filled with PENETROX™ joint compound to limit oxide growth and increase the life of the connection.

Variations:

- Remove "S" for no PENETROX™
- Add "SS" for stainless steel hardware
- Add "C" to include a cover
- Add "HN" for shear nut
- Cover may be ordered separately (UCTCOVER)
- * Not available with cover or shear nut

— Not recommended for Copper to Copper applications; use Copper FASTAP™ connector (see next page)

To ensure proper tightening torque, use BURNDY® BTW Torque Wrenches.

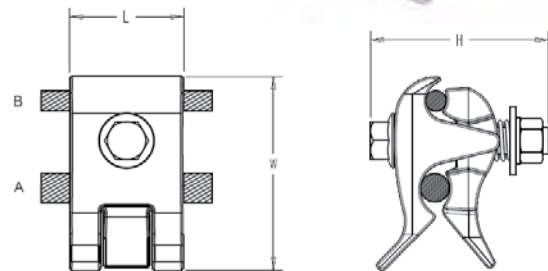

Catalog Number	Conductor Range				Conductor Diameter				Torque (in-lb)	Wrench Size	# of Bolts	Dimensions		
	Groove A (Run)		Groove B (Tap)		Groove A (Run)		Groove B (Tap)					L	H	W
	Copper & Aluminium	ACSR, 6201 & 5005	Copper & Aluminium	ACSR, 6201 & 5005	Min	Max	Min	Max						
UCT26RS	8 Sol - 2/0 Str	6 Str - 2/0 Str	8 Sol - 2/0 Str	6 Str - 2/0 Str	0.13	0.45	0.13	0.45	250	9/16	1	1.62	2.62	2.50
UCT32RS	1 Sol - 400	2 Str - 336.4	8 Sol - 4/0 Str	6 Str - 4/0 Str	0.29	0.73	0.13	0.56	250	9/16	1	1.62	2.62	2.82
UCT41R28RS*	250 Str - 650 Str	4/0 (6/1) - 556.5 (30/7)	6 Sol - 4/0 Str	6 Str - 4/0 Str	0.56	0.95	0.16	0.56	480	3/4	1	2.66	4.37	4.57
UCT41R41RS*	250 Str - 650 Str	4/0 (6/1) - 556.5 (30/7)	250 Str - 650 Str	4/0 (6/1) - 556.5 (30/7)	0.56	0.95	0.46	0.95	480	3/4	2	4.20	4.37	5.23

Copper FASTAP™ with Lineman Assist™, Type UCT For Copper

Material: Copper
(Silicon Bronze / Stainless Hardware)

The BURNDY® FASTAP™ with Lineman Assist™ mechanical connector utilizes a spring system that acts as a third hand to assist in installation. This system helps secure the tap conductor while installing on Primary, Secondary, and service applications. The duck bill handle simplifies installation by providing a handle to easily hold the connector while wearing dielectric gloves. Conductor side entry facilitates installation and also helps keep inhibitor in the connector.

Variations:

- Add "SS" for stainless steel hardware
- Add "C" to include a cover
- Add "HN" for shear nut
- Cover may be ordered separately (UCTCOVER)

To ensure proper tightening torque, use BURNDY® BTW Torque Wrenches.

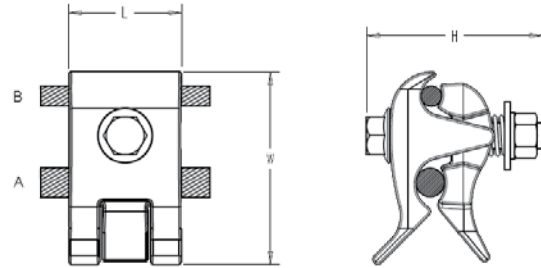

Catalog Number	Conductor Range		Conductor Diameter				Torque (in-lb)	Wrench Size	Dimensions		
	Groove A (Run)	Groove B (Tap)	Groove A (Run)		Groove B (Tap)				L	H	W
	Copper	Copper	Min	Max	Min	Max					
UCT26	8 Sol - 2/0 Str	8 Sol - 2/0 Str	0.13	0.45	0.13	0.45	240	9/16	1.62	2.62	2.50
UCT32	1 Sol - 400	8 Sol - 4/0 Str	0.29	0.73	0.13	0.56	240	9/16	1.62	2.62	2.82

Connector/Cover Kit, Type UC-KIT

Includes Type UC connector and Cover

Type UC connector accommodates a large range of copper conductors in either groove. Kits include the connector and cover.

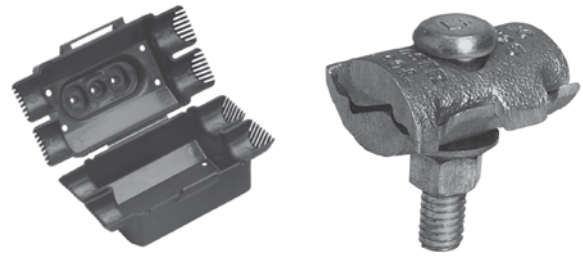

Catalog Number	Conductor (Either Groove)	Dimensions				Wrench	Torque
		L	H	J	W		
UC6W25CONKIT	6 Sol. - 1/0 Str.	1-3/4"	1-5/8"	[3/8]"	1-3/8"	9/16	240
UC4W28CONKIT	4 Sol. - 4/0 Str.	2-1/8"	2"		1-3/4"		

Note: For connectors with break-away bolt contact factory.

TAPIT™ Connector Cover, Type UC-COVER

For Select Types UC, UCG Tap Connector

High density polyethylene cover accommodates several sizes of Types UC and UCG connectors. One piece design; simply slip over the connector and snap shut. Supplied in black.



Catalog Number: UCCOVER1BOX25

For use with following connectors:

UCG25R2RS	UCG25R2R
UCG25RS	UCG25R
UCG28RS	UCG28R
UC25R2RS	UC25R2R
UC28RS	UC28R
UC6W25	UC4W25

FASTAP™ Connector Cover, Type UCTCOVER

For Select Types UCT, UCG Tap Connectors

High density polyethylene cover accommodates all FASTAP™ connectors and select Type UCG connectors. One piece design; simply slip over the connection and snap shut. Supplied in black.

Catalog Number: UCTCOVER

For use with following connectors:

UCT26
UCT32
UCT26RS
UCT32RS
UCG32RS
UCG26RS



Lightning Shield Clamp, Type LSC

For AAC and ACSR Primary Covered Conductor (Tree Wire)

Material: Aluminum (Cast)

Cast aluminum lightning shield clamp with a galvanized steel eye bolt for use on covered aluminum and ACSR primary overhead distribution conductors (Tree Wire). These clamps are designed to protect the Tree Wire from burn-down causing service interruption during high lightning activity. For further application details, contact the factory.

Conductor groove is pre-filled with PENETROX™ A-13 oxide inhibitor, which is compatible with cable insulation and individually bagged.

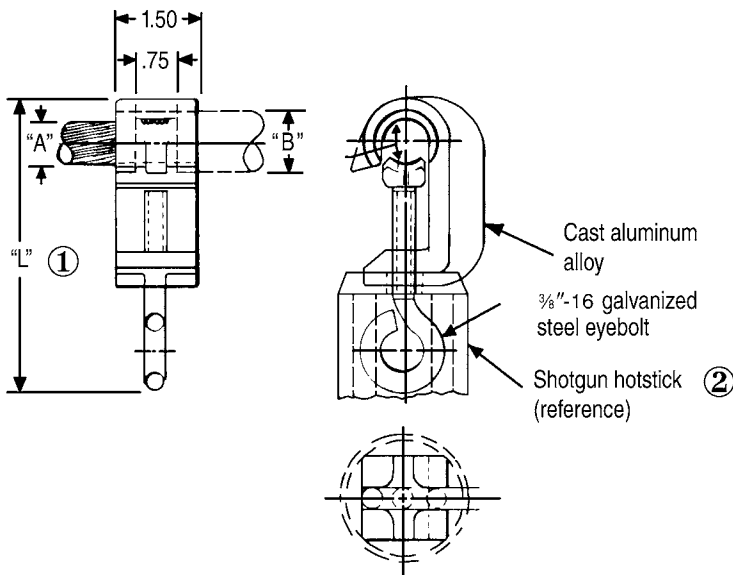

① Approx. assembly length over eyebolt with cable clamped. Also approx. eyebolt position when shipped.

② Assembly can be installed using a shotgun hotstick as shown. Assembly instructions are supplied with each connector.

Catalog Number	Cable	Accommodates Cable Dia. "A"	Insul. Dia. "B" (Max.)	"L"
LSC1/0	1/0 Str. ACC - 1/0 ACSR	0.368 - 0.398	0.65"	4.50"
LSC1/01	1/0 Str. AAC - 1/0 ACSR	0.368 - 0.398	0.83"	4.50"
LSC556	4/0 Str. - 556.5 AAC	0.528 - 0.858	1.16"	5.90"
LSC5561	4/0 Str. - 556.5 AAC	0.528 - 0.858	1.34"	5.90"

Compression Tap Connectors General Overview

The BURNDY line of compression connectors are wide range-taking; accommodate copper, aluminum and ACSR; are easy to install; and are dependable and economical. They are designed to be installed with BURNDY® “matched” hand, hydraulic, and power-driven hydraulic tooling. The connector line consists of C-shaped, Figure 3, Figure 6-shaped, and HYCRIMP™ tap connectors, disconnectable T-taps, terminals and STIRRUP™ connectors.

The copper CRIMPIT™ is a range-taking, reversible, C-shaped compression tap connector for combinations of copper conductors. Twelve connectors take tap combinations from #10 AWG through 4/0, and all sizes are installed with dies that also install aluminum connectors. Sizes accommodating conductors up to #2 may be installed with the MD6 and OUR840 type tools. All sizes may be installed with the 35 or 750 family of tools. They make “hot” installation easy by permitting the lineman to grip the CRIMPIT™ in the compression tool and then place it on the line. The tap is then inserted and the CRIMPIT™ is compressed. Massive C-shape forces tap and line conductors together to form dependable, low-cost, low-resistance connections.

The CABELOK™ CRIMPIT™ is a range-taking universal and reversible, Figure 3-shaped aluminum compression tap connector with an adjustable spacer which separate the conductors. It accommodates combinations of copper, aluminum, and ACSR conductors from #6 up to 4/0, and is installed with the common O and D3 dies. The broad range capacity of each CABELOK™ CRIMPIT 2 reduces the number of connectors required and simplifies connector selection.

The spacer holds the run or tap in place permitting the lineman either to approach the line with the connector held in the tool and with the tap in the connector, or to assemble the connector and tap on the line and then bring up the tool to crimp.

Each CABELOK™ CRIMPIT™ is pre-filled with PENETROX™ joint compound and individually bagged. These packages are clearly marked with the entire conductor range of the connector as well as pertinent tooling information. The open side of the CABELOK™ CRIMPIT™ makes “hot” installations easy by allowing the connector to be carried to the energized line in the crimping tool (MD6, 35, or 750 families hot-line styles).

The Figure 6-shaped aluminum compression tap connector is one of the widest range-taking compression tap connectors available. It accommodates copper, aluminum, or ACSR conductors in very broad ranges. Only four connectors are required to accommodate a range from #6 to 600 kcmil. This broad range is made possible by the long ram stroke of the 35 and 750 series tools.

HYCRIMP™ compression tap connectors accommodate ACSR, stranded copper or aluminum, solid copper or aluminum, and compact conductors. Seventeen sizes are available to accommodate all conductors from #6 solid to 954 kcmil compact. All HYCRIMP™ connectors can be installed with industry standard O, D, N and R dies. Each connector is factory-filled with BURNDY® PENETROX™ joint compound, and individually boxed for ease of handling, identification, and installation.

The BURNDY® line of disconnectable T-taps and jumper loop slices offer an economical approach to sectionalizing or isolating equipment on energized lines. They combine the best features of compression and mechanical connectors. The pads can be easily assembled or separated from each other with hot-line tools.

The STIRRUP™ combines a compression C-shaped Figure 6-shaped or H-shaped element for the run conductor, and a factory installed bail which accommodates a hot-line clamp. The line element can be gripped in the tool and carried to the line and then crimped.

Note: Aluminum bodied compression tap connectors are not recommended for making copper to copper connections. Two connectors are recommended when feeding a line in both directions.

Overhead Distribution

Compression Tap Large Range Taking
COPPER CRIMPIT™ Types YC-C, YP-C

Copper CRIMPIT™ Connector, Type YC-C For Copper, Copperweld

Material: Copper
UL Listed 90° C, Up to 35 kV ♦



Range-taking compression tap connector made of pure copper. Designed to be gripped in the jaws or dies of installation tool, then slipped directly over line for easy installation. Also used for deadending applications.

Copperweld-Copper Conductors

8A - Use CRIMPIT™ accommodating 6 Str. Copper

6A - Use CRIMPIT™ accommodating 4 Str. Copper

4A - Use CRIMPIT™ accommodating 2 Str. Copper

2A - Use CRIMPIT™ accommodating 1/0 & 2/0 Copper

** Multiple crimp die set. Makes more than one crimp per tool compression. Figure () indicates number of compressions.

† Not UL Listed.

‡ Number of crimps.

* U Die with adapter PUADP1.

§ Not UL Listed or CSA Certified with this conductor size in run.

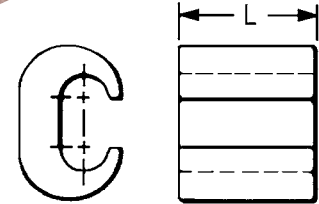

RUS Accepted

Catalog Number	Run	Tap	L	▲ Die Index	Tools, Die Set, Catalog Number and (‡No. of Crimps) ▲			CRIMPIT™ for 1 Str. Copper	
					MD6	OUR840	35, 750 Series, Y45, 46 Series*	Run	Tap
YC10C10 †	12 Sol.-10 Str.	12 Sol.-10 Str.	.32	238	W238 (1)	W238 (1)	U238 (1)	—	—
YC8C8	8 Sol.-8 Str.	10 Sol.- 8 Str.	.50	162	W162 (2)	W162 (2)	U162** (1)	—	—
YC4C8	6 Sol.-4 Str.	8 Sol.- 8 Str.	.62	BG or 5/8	BG (2) WBG** (1)	XBG (2) XNBG (2)	UBG (1)	—	—
YC4C6		6 Sol.- 6 Str.	.57						
YC4C4		6 Sol.- 4 Str.							
YC2C4	4 Sol.-2 Str.	8 Sol.- 4 Str.	.67	C	WC (2)	—	UC (1)	1 Str. §	6, 8 Str., 8 Sol.
YC2C2	2 Sol.-2 Str.	2 Sol.- 2 Str.	.92	E or O	—	—	UE (3) UO (1)	—	—
YC26C2	1/0 Str.-2/0 Str.	8 Sol.- 2 Str.						1 Str. §	1 or 2 Str.
YC26C26		1/0 Str.- 2/0 Str.						—	—
YC28C2	3/0 Str.-4/0 Str.	6 Sol.- 2 Str.	1.07	F or D3	—	—	UF (3) UD3** (1)	—	—
YC28C26		1/0 Str.- 2/0 Str.							
YC28C28		3/0.- 4/0 Str.							

Copper CRIMPIT™ Tap Connector, Type YP-C For Copper

Material: Copper

Figure "6" shaped, wide range-taking copper compression tap connector for primary service taps and secondary service drops. Connector can be gripped in tool and slipped over the line for easy installation.

Catalog Number	D	Run	Tap	Die Index	Tools, Die Set Catalog Number, & (# of Crimps) 35, 750 Series, Y45 †, 46 Series ‡
YP2C2	0.75	6 Sol. - 2 Str.	6 Sol. - 2 Str.	O	UO (1)
YP28C28	1.00	2/0 Sol. - 4/0 Str.	2/0 Sol. - 4/0 Str.	D	UD3 (1)
YP29C26	0.75	1/0 Sol. - 250	4 Sol. - 2/0 Str.		

† U Die with adapter PT6515.

‡ U Die with adapter PUADP1.

For faster installations use BURNDY® PATRIOT® family of battery tools, dies and cutters.

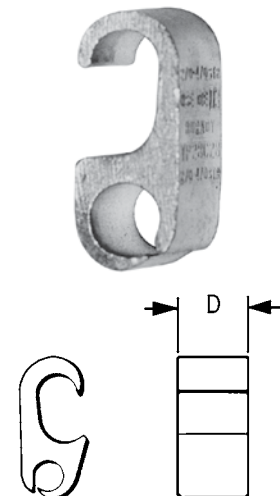

Aluminum CRIMPIT™ Connector, Type YC-A

For AAC (Stranded, Compressed, Compact), ACSR, AAAC

Material: Aluminum

Range-taking C-shaped aluminum compression tap or deadending connector designed to eliminate effects of cold flow. Can be gripped in tool and slipped over line for easy crimping. Pre-filled with PENETROX™ joint compound and stripealed to limit oxide growth and increase the life of the connection.

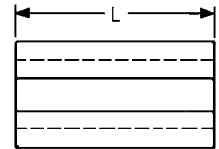

Catalog Number	Run		Tap		L	Die Index	Tools, Die Set Catalog Number, & (# of Crimps)	
	Aluminum	ACSR, 6201, 5005	Aluminum	ACSR, 6201, 5005			MD7, MD6	35, 750 Series, Y45 †, 46 Series ‡
YC4A6	6 Sol. - 4 Str.	6	6 Sol. & Str.	—	1-1/4"	5/8 or BG	BG (4) WBG (2)*	UBG (2)*
YC4A4			4 Sol. & Str.	6				
YC2A4	2 Sol. & Str.	4 - 2	4 Sol. & Str.	6	1-1/2"	C	WC (4)	UC (2)*
YC2A2			2 Sol. & Str.	4 - 2				
YC25A4	1/0 Str.	1/0	6 Str. - 4 Str.	6 - 4	1-1/2"	C	WC (4)	UC (2)*
YC25A2			2 Sol. & Str.	2	2-1/4"	C	WC (6)	UC (3)*
YC25A25			1/0 Str. - 2/0 Str.	1/0 Str. - 2/0 Str.	1/0	1-3/4"	Q	WQ (6)*
YC26A25	1/0 Str. - 2/0 Str.	1/0 - 2/0	1/0 Str.	1/0	2-1/2"	D**	—	UD (3)
YC26A26			2/0 Str.	2/0				
YC28A2	3/0 Str. - 4/0 Str.	3/0 - 4/0	6 Sol. - 2 Str.	6 - 2	2-3/4"	H	—	UH (3)
YC28A25			1/0 Str.	1/0				
YC28A26			2/0 Str.	2/0				
YC28A28			3/0 Str. - 4/0 Str.	3/0 - 4/0				
YC33R26	300 - 397.5	336.4 (18-1) (26-7)	2 Str. - 2/0 Str.	2 - 1/0	1-1/2"	R	—	UR (2)

* Multiple crimp die set; makes more than one crimp per tool compression. Figure indicates number of compressions.

** Index number "D" is not "D3" Cabelok CRIMPIT™ die.

† U Die with adapter PT6515.

‡ U Die with adapter PUADP1.

For faster installations use BURNDY® PATRIOT® family of battery tools, dies and cutters.



CABELOK™ CRIMPIT™ Connector, Type YP-U

For Copper, AAC (Stranded, Compressed, Compact),
ACSR, AAAC



Material: Aluminum

Wide range-taking, universal, and reversible, Figure 3-shaped aluminum connector with adjustable overhanging spacer that separates conductors. Spacer holds run or tap in place permitting lineman to either approach the line ready to crimp, or to assemble connector and tap on run and then crimp. Massive aluminum design minimizes conductor corrosion due to galvanic action. Pre-filled with PENETROX™ joint compound and stripealed to limit oxide growth and increase the life of the connection. Conductor range and tooling information clearly printed on both connector and packaging.

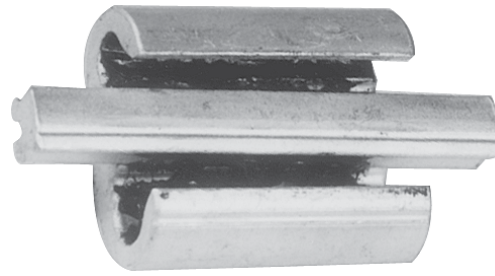

RUS Accepted

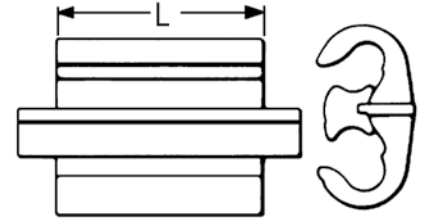

Catalog Number	Conductor (See Chart Below for Compressed Conductor)						L	Die Index	Tools, Die Set Catalog Number, & (# of Crimps)	
	Groove A			Groove B					MD7, MD6	35, 750 Series, Y45 †, 46 Series ‡
	Solid	Stranded	ACSR	Solid	Stranded	ACSR				
YP2U3*	6, 4, 3, 2	6, 4, 3	6,4	6, 4, 3, 2	6, 4, 3	6,4	1-1/2"	O	WO (4)	UO (1)
YP26AU2	1, 1/0, 2/0, 3/0	2, 1, 1/0, 2/0	3, 2, 1, 1/0	6, 4, 3, 2, 1, 1/0	6, 4, 3, 2, 1	6, 4, 3, 2	1-5/8"	D3	MD6 (4)	UD3 (1)
YP25U25**	2/0, 3/0	1, 1/0, 2/0	1, 1/0	2/0, 3/0	1, 1/0, 2/0	1, 1/0				
YP27AU4	2/0, 3/0, 4/0	1,0, 2/0, 3/0	1/0, 2/0	6, 4, 3, 2	6, 4, 3	6, 4				
YP27AU2				2, 1, 1/0	3, 2, 1	4, 3, 2				
YP27AU26	3/0, 4/0	2/0, 3/0	2/0	2/0, 3/0	1/0, 2/0	1, 1/0, 2/0				
YP28U2	—	4/0	3/0, 4/0	2, 1, 1/0	4, 3, 2, 1	4, 3, 2				
YP28U26				2/0, 3/0	1/0, 2/0	1, 1/0, 2/0	3-1/2"	MD6 (9)	UD3 (2)	

Catalog Number	Compressed Conductor				L	Die Index	Tool, Die Set Catalog No., & (# of Crimps)	
	Groove A		Groove B				MD7, MD6	35, 750 Series, Y45 †, 46 Series ‡
	Stranded Aluminum	ACSR	Stranded Aluminum	ACSR				
YP2U3	6, 4, 3, 2	6, 4, 3	6, 4, 3, 2	6, 4, 3	1-1/2"	O	WO (4)	UO(1)
YP26AU2	2, 1, 1/0, 2/0	2, 1, 1/0, 2,0	6, 4, 3, 2, 1	6, 4, 3, 2, 1	1-5/8"	D3	MD6 (4)	UD3 (1)
YP25U25	1/0, 2/0	1/0, 2/0	1/0, 2/0	1/0, 2/0				
YP27AU4	2/0, 3/0	1/0, 2/0, 3/0	6, 4, 3	6, 4, 3				
YP27AU2			3, 2, 1	4, 3, 2, 1				
YP27AU26	3/0	2/0, 3/0	1/0, 2/0, 3/0	1/0, 2/0				
YP28U2	4/0, 250, 266.8	4/0, 266.8, (18/1)	3, 2, 1	4, 3, 2, 1				
YP28U26			1/0, 2/0, 3/0	1/0, 2/0	3-1/2"	MD6 (4)	UD3 (1)	
YP28U28			3/0, 4/0	3/0, 4/0	3/0, 4/0	2-3/4"	—	UD3 (2)

* TAKES UP to #2 ACSR maximum in either groove if other wire is #2 solid or smaller.

** TAKES DOWN to #2 ACSR minimum in either groove if other groove wire is 1/0 stranded or larger.

† U Die with adapter PT6515.

‡ U Die with adapter PUADP1.

Not recommended for copper to copper applications. Use a copper connector to increase connection life.

For faster installations use
BURNDY® PATRIOT® family of
battery tools, dies and cutters.



Universal CRIMPIT™ Connector, Type YPC-U

For Copper, AAC (Stranded, Compressed, Compact),
ACSR, AAAC

Material: Aluminum

Extra wide range universal connector. Two dies and 5 connectors take run sizes from 1/0 to 600 kcmil and tap sizes #6 to 400 kcmil. Wide range acceptance made possible by long ram travel of BURNDY® HYPRESS™ tools. Figure 6-shape separates run and tap wires, minimizing galvanic corrosion of conductors. Connector can be gripped in tool and slipped over line for easy installation. Pre-filled with PENETROX™ joint compound and stripsealed to limit oxide growth and increase the life of the connection.

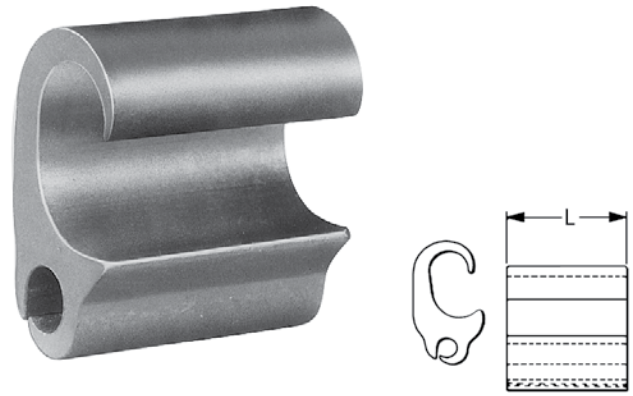

Ⓢ 2/0 Str. Cu Aluminum and 2/0 ACSR may also be installed in run when tap is 3/0 Str. or larger.
Ⓢ YPC28U4 only may be installed with MD6 HYTOOL™ and the BCT500HS with D3 groove.

† U Die with adapter PT-6515.
‡ U Die with adapter PUADP-1.
Not recommended for copper to copper applications.
Use a copper connector to increase connection life.

Catalog Number	Run		Tap		L	Die Index	Tools, Die Set Catalog Number, & (# of Crimps)		
	Aluminum & Copper	ACSR, 5005	Aluminum & Copper	ACSR, 5005			35, 750 Series	Y45 †	46 Series‡
YPC28U4	3/0 - 4/0 Str. & 4/0 - 250, 266.8 Alum. Compressed	3/0 - 4/0 & 4/0, 266.8 (18/1) ACSR Compressed	6, 4, 3 Str. 6, 4, 3, 2 Sol. & 6, 4, 3 Alum. Compressed	6, 4, 3 ACSR Compressed	1-5/8	D3 Ⓢ	UD3 (1)	UD3 (1)	UD3 (1)
YPC28U26	1/0 (7) - 4/0 (7)	1/0 - 4/0	3 Sol. - 2/0 (7)	4 - 1/0	2-3/4	D3	UD3 (2)	—	—
YPC28U28 Ⓢ	3/0 - 4/0 Str. 4/0 Sol. & 4/0, 250, 266.8 Alum. Compressed	3/0 - 4/0 Str. & 3/0, 4/0, 266.8 (18/1) ACSR Compressed	2/0 - 4/0 Str. 4/0 Sol. & 3/0, 4/0, 250, 266.8 Alum. Compressed	2/0 - 4/0 Str. & 3/0, 4/0, 266.8 (18/1) ACSR Compressed	2-3/4	D3	UD3 (2)	UD3 (2)	UD3 (2)
YPC33R26U	250 (37) - 400 (37)	266.8 (18-1) - 397.5 (18-1)	6 Sol. - 2/0 (19)	6 - 1/0	2-1/8	N	UN (2)	SN (2)	PN (2)
YPC33R28R	250 (37) - 477 (37)	266.8 (18-1) - 397.5 (18-1)	2/0 (19) - 4/0 (19)	2/0 - 4/0	8-7/8	N	UN (3)	SN (3)	PN (3)
YPC33R33R	250 (37) - 400 (37)	266.8 (18-1) - 397.5 (18-1)	250 (37) - 400 (37)	266.8 (18-1) - 397.5 (18-1)	8-7/8	N	UN (3)	SN (3)	PN (3)
YPC38R26U	477 (19) - 600 (61)	397.5 (26-7) - 556.5 (18-1)	6 Sol. - 2/0 (19)	6 - 1/0	2-1/8	N	UN (2)	SN (2)	PN (2)
YPC36A36	397.5 (19) - 600 (61)	336.5 (26-7) - 556.5 (18-1)	397.5 (19) - 600 (61)	397.5 (26-7) - 556.5 (18-1)	6-3/4	Z	—	SZ (4)	—
YPC40A32	600 (61) - 800 (61)	556.6 (18-1) - 795 (26-7)	2/0 (7) - 400 (37)	2/0 (6-1) - 397.5 (18-1)	5	T	—	ST (3)	—
YPC40A36	600 (61) - 800 (61)	556.6 (18-1) - 795 (26-7)	397.5 (19) - 600 (61)	336.4 (26-7) - 556.5 (18-1)	5	T	—	ST (3)	—
YPC40A40	600 (61) - 954 (61)	556.6 (18-1) - 795 (26-7)	600 (61) - 954 (61)	556.5 (18-1) - 795 (26-7)	9-7/8	T	—	ST (6)	—

For faster installations use BURNDY® PATRIOT® family of battery tools, dies and cutters.



Universal CRIMPIT™ Connector, Type YC-U

For Copper, AAC (Stranded, Compressed, Compact), ACSR, AAAC

Material: Aluminum

Figure 6-shaped, wide range-taking aluminum compression tap connector for smaller primary service taps and secondary service drops. Minimizes galvanic corrosion of conductors. Connector can be gripped in tool and slipped over line for easy installation. Installed with aluminum CRIMPIT™ connector dies. Pre-filled with PENETROX™ joint compound and stripsealed to limit oxide growth and increase the life of the connection.

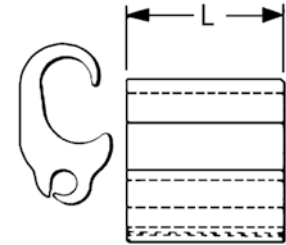

Catalog Number	Run		Tap		L	Die Index	Die Set Catalog No., & (# of Crimps) 35, 750 Series, Y45 †, 46 Series ‡
	Aluminum & Copper	ACSR, 6201, 5005	Aluminum & Copper	ACSR, 6201, 5005			
YC4U1	4 Sol. - 4 Str.	4	6 Sol. - 1 Str.	6 - 1 Str.	1-7/8	D*	UD (2)
YC1U1	2 Str. - 1 Str.	2					
YC28U26	1/0 Str. - 4/0 Str.	1/0 - 4/0	6 Sol. - 1/0 Str.	6 - 1/0	2-1/8	H	UH (2)
YC33R26U	300 - 400	266.8 (6-7) - 336.4 (30-7)				R	UR (2)

* Die Index "D" is not Die Index "D3" (CABLELOK™ & Universal CRIMPIT™ Die).

† U Die with adapter PT6515.

‡ U Die with adapter PUADP1.

Not recommended for copper to copper applications. Use a copper connector to increase connection life.

For faster installations use BURNDY® PATRIOT® family of battery tools, dies and cutters.



Street Lighting Tap, Types YPC-A-U, YPC-R-U

For Copper, AAC (Stranded, Compressed, Compact), ACSR, AAAC

Material: Aluminum

Compact compression connector designed to tap small lighting wires from secondaries. Figure 6-shape separates run and tap, minimizing galvanic corrosion. Connector can be gripped in tool and slipped over line for easier installation. Pre-filled with PENETROX™ joint compound and stripsealed to limit oxide growth and to increase the life of the connection.

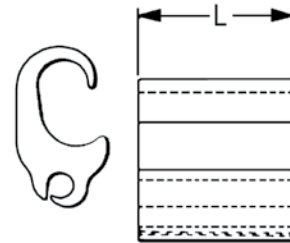

Catalog Number	Run				Tap	L	Die Index	Tools, Die Set Catalog Number, & (# of Crimps)		
	ACSR	Compressed ACSR	Aluminum & Copper	Compressed Aluminum	Aluminum & Copper			MD7, MD6	35 and 750 Series, Y45 †, Y46 ‡	OUR840
YPC2A8U	6 - 4	6 - 2	4 - 2 Sol. 6 - 2 Str.	4 - 2	14 Sol. - 8 Str.	5/8	BG or 5/8	BG (1) WBG (1)*	UBG (1)	XBG
YPC26R8U	2 - 3/0	1 - 3/0	1 - 3/0	1/0 - 3/0	14 Sol. - 8 Str.	3/4	O	WO (2)	UO (1)	WO

* Multiple crimp die set, makes more than one crimp per tool compression.

Figure indicates number of compressions.

Not recommended for copper to copper applications. Use a copper connector to increase connection life.

For faster installations use BURNDY® PATRIOT® family of battery tools, dies and cutters.



CRIMPIT™ Connector Cover, Type CC

For all O, D, and N Die Tap Connectors

Material: Polyethylene

High density polyethylene cover accommodates most industry connectors in the O, D, and N range. Four sizes cover the full #6 to 600 kcmil conductor range. One piece design, no extra hardware needed. Simply slip over connector and snap shut. Supplied in black.



Catalog Number	Maximum Connector Length	Connector Series Accommodated
CCO	2-1/2	O Die
CCD	2-3/4	D Die
CCN	2-1/8	Short N Die
CCNL	5-3/16	Long N Die and YP28U26

3 Simple Selection Steps for BURNDY® HYCRIMP™ and LOKTAP™ Compression Tap Connectors:

1. Follow down from the smaller wire.
2. Go across from the larger wire.
3. Intersection of the two shows the proper connector.

Example:

#2 ACSR to #1/0 Stranded would fall in Zone 2; Catalog Number: YHO150 (HYCRIMP™) or YHO2 (LOKTAP™)

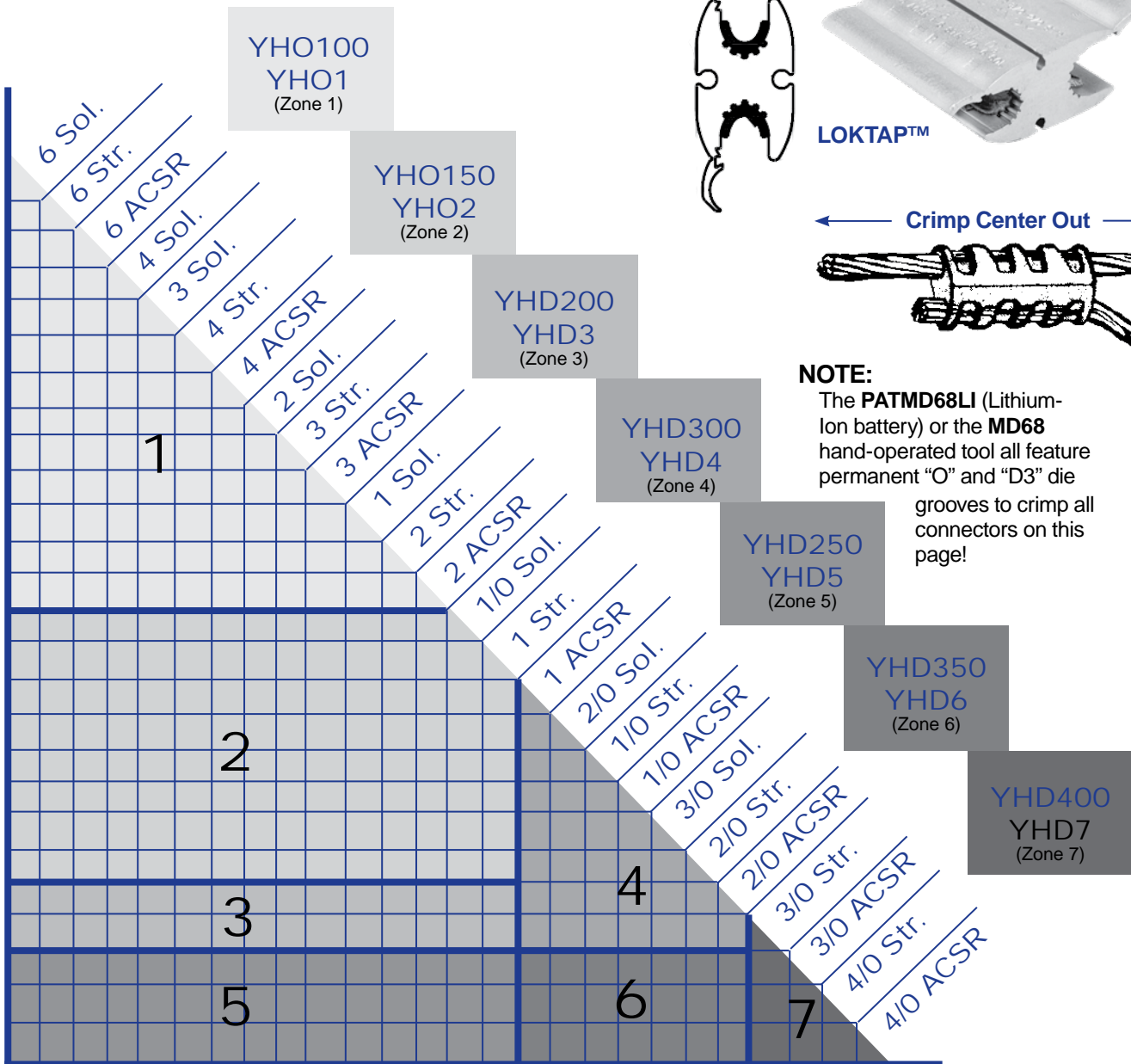
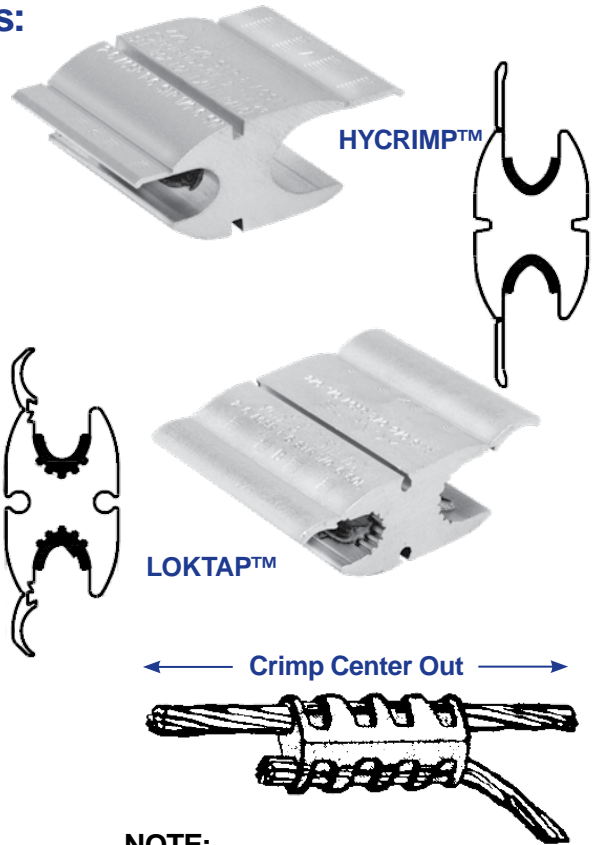

NOTE:

The PATMD68LI (Lithium-Ion battery) or the MD68 hand-operated tool all feature permanent "O" and "D3" die grooves to crimp all connectors on this page!

HYCRIMP™ H-Shaped Connector, Types YHO, YHD

For Aluminum (Stranded, Compressed, Compact), Copper, ACSR, AAAC, Steel

Material: Aluminum

Wide range, universal, reversible, Figure H aluminum connector. Conductors are separated by the shape of the connector. Bendable tabs secure both run and tap conductors freeing lineman's hands to work with installation tool. Massive aluminum design minimizes corrosion due to galvanic corrosion. Pre-filled with PENETROX™ joint compound and stripsealed to limit oxide growth and increase life of the connection. Individually packaged; conductor ranges and tooling information clearly printed on connector and packaging.

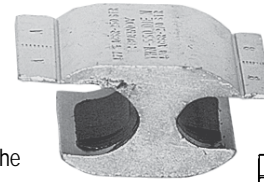

RUS Accepted

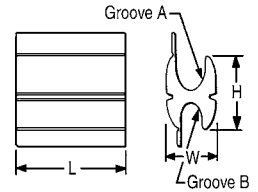

Handtool or Hydraulic 7 Connector Program														
Catalog Number	Code No.	Conductors (See Below for Compact Conductors)								Dimensions			Installation Data	
		Groove A (Run)				Groove B (Tap)							Tool Series, Die Set Cat. No. & (# Crimps)	
		Wire Diameter Range	Sol.	Str.	ACSR	Wire Diameter Range	Sol.	Str.	ACSR	H	L	W	MD78 MD68	35, 750, Y45†, 46†
YHO100	1	0.162-0.332	#6 - #1	#6 - #1	#6 (6/1) - #2 (7/1)	0.162-0.332	#6 - #1	#6 - #1	6 (6/1) - 2 (7/1)	1.12	1.25	0.70	⊙ (4)	UO (2)
YHO150	2	0.260-0.419	#1 - 2/0	#3 - 2/0	#3 (6/1) - 1/0 (6/1)	0.162-0.332	#6 - 1/0	#6 - #1	6 (6/1) - 2 (7/1)	1.13	1.50	0.70	⊙ (5)	UO (2)
YHD200	3	0.398-0.470	3/0 - 4/0	2/0 - 3/0	1/0 (6/1) - 2/0 (6/1)	0.162-0.332	#6 - 1/0	#6 - #1	6 (6/1) - 2 (7/1)	1.45	1.62	0.89	⊙ (5)	UD3 (2)
YHD250	5	0.475-0.563	250 - 300	4/0	3/0 (6/1) - 4/0 (6/1)	0.162-0.332	#6 - 1/0	#6 - #1	6 (6/1) - 2 (7/1)	1.47	1.62	0.89	⊙ (5)	UD3 (2)
YHD300	4	0.336-0.470	2/0 - 4/0	#1 (3) - 3/0	#1 (6/1) - 2/0 (6/1)	0.336-0.447	2/0 - 3/0	#1 - 2/0	1 (6/1) - 2/0 (6/1)	1.42	1.62	0.89	⊙ (5)	UD3 (2)
YHD350	6	0.461-0.563	250 - 300	3/0 - 4/0	3/0 (6/1) - 4/0 (6/1)	0.336-0.447	2/0 - 3/0	#1 - 2/0	1 (6/1) - 2/0 (6/1)	1.42	2.25	0.89	⊙ (7)	UD3 (3)
YHD400	7	0.461-0.563	250 - 300	3/0 - 4/0	3/0 (6/1) - 4/0 (6/1)	0.461-0.563	250 - 300	3/0 - 4/0	3/0 (6/1) - 4/0 (6/1)	1.40	2.50	0.84	⊙ (7)	UD3 (3)

Compact Conductors								Installation Data		
Catalog Number	Code No.	Groove A (Run)			Groove B (Tap)			Tool Series, Die Set Catalog No. & (# of Crimps)		Die Index
		Wire Diameter Range	Compact ACSR	Compact CU or AL	Wire Diameter Range	Compact ACSR	Compact CU or AL	MD78 MD68	35, 750, Y45†, 46†	
YHO100	1	0.162-0.332	#6 - #1	#6 - #4 - #1	0.162-0.332	#6 - #1	#6 - #1	⊙ (4)	UO (2)	O
YHO150	2	0.260-0.419	#2 - 1/0	#2 - 2/0	0.162-0.332	#6 - #1	#6 - #1	⊙ (5)	UO (2)	O
YHD200	3	0.398-0.470	2/0 - 3/0	3/0	0.162-0.332	#6 - #1	#6 - #1	⊙ (5)	UD3 (2)	D3
YHD250	5	0.475-0.563	4/0 - 266.8	4/0 - 266	0.162-0.332	#6 - #1	#6 - #1	⊙ (5)	UD3 (2)	D3
YHD300	4	0.336-0.470	1/0 - 3/0	1/0 - 3/0	0.336-0.447	1/0 - 2/0	1/0 - 3/0	⊙ (5)	UD3 (2)	D3
YHD350	6	0.461-0.563	3/0 - 266.8	4/0 - 266	0.336-0.447	1/0 - 2/0	1/0 - 3/0	⊙ (7)	UD3 (3)	D3
YHD400	7	0.461-0.563	3/0 - 266.8	4/0 - 266	0.461-0.563	3/0 - 266.8	4/0 - 266	⊙ (7)	UD3 (3)	D3

Handtool or Hydraulic 4 Connector Program													
Catalog Number	Conductors (See Below for Compact Conductors)								Dimensions			Installation Data	
	Groove A (Run)				Groove B (Tap)							Tool Series, Die Set Cat. No. & (# of Crimps)	
	Wire Dia. Range	Sol.	Str.	ACSR	Wire Dia. Range	Sol.	Str.	ACSR	H	L	W	MD78 MD68	35, 750, Y45†, 46†
YHO125	0.162-0.398	#6 - 2/0	#6 - 1/0	6 (6/1) - 1/0 (6/1)	0.162-0.332	#6 - 1/0	6 - #1	#6 (6/1) - #2 (7/1)	1.15	1.62	0.70	O	UO (2)
YHD250	0.475-0.563	250 - 300	4/0	3/0 (6/1) - 4/0 (6/1)	0.162-0.332	#6 - 1/0	6 - #1	#6 (6/1) - #2 (7/1)	1.47	1.62	0.89	D3	UD3 (2)
YHD350	0.461-0.563	250 - 300	3/0 - 4/0	3/0 (6/1) - 4/0 (6/1)	0.336-0.447	2/0 - 3/0	#1 - 2/0	#1 (6/1) - 2/0 (6/1)	1.42	2.25	0.89	D3	UD3 (3)
YHD400	0.461-0.563	250 - 300	3/0 - 4/0	3/0 (6/1) - 4/0 (6/1)	0.461-0.563	4/0	3/0 - 4/0	3/0 (6/1) - 4/0 (6/1)	1.40	2.50	0.84	D3	UD3 (3)

Compact Conductors							Installation Data			
Catalog Number	Groove A (Run)			Groove B (Tap)			Tool Series, Die Set Catalog No. & (No. of Crimps)		Die Index	
	Wire Diameter Range	Compact ACSR	Compact CU or AL	Wire Diameter Range	Compact ACSR	Compact CU or AL	MD78 MD68	35, 750, Y45†, 46†		
YHO125	0.162-0.398	#6 - 2/0	#6 - 1/0	0.162-0.332	#6 - #1	#6 - #1	O	UO (2)	O	
YHD250	0.475-0.563	4/0 - 266.8	4/0 - 266	0.162-0.332	#6 - #1	#6 - #1	D3	UD3 (2)	D3	
YHD350	0.461-0.563	3/0 - 266.8	4/0 - 266	0.336-0.447	#1 - 2/0	1/0 - 3/0	D3	UD3 (3)	D3	
YHD400	0.461-0.563	3/0 - 266.8	4/0 - 266	0.461-0.563	3/0 - 266.8	4/0 - 266	D3	UD3 (3)	D3	

† U Die with adapter PT6515

‡ U Die with adapter PUADP1

⊙ See previous page for Seven Connector Selector Chart.

© Permanent dies in tool install all sizes.

Not recommended for copper to copper applications. Use a copper connector to increase connection life.

HYCRIMP™ Connector, Types YHN, YHR

For Aluminum (Stranded, Compressed, Compact), Copper, ACSR, AAAC, Steel

Material: Aluminum

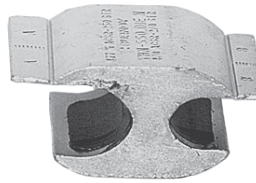

RUS Accepted

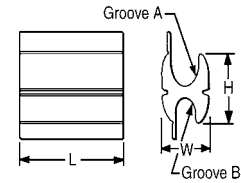

N Die Connectors*													
Catalog Number	Conductors (See Below for Compact Conductors)							Dimensions			Installation Data		
	Groove A (Run)			Groove B (Tap)							Tool, Die Set Catalog No. & (# of Crimps)		
	Wire Diameter Range	Str.	ACSR	Wire Diameter Range	Sol.	Str.	ACSR	H	L	W	35 and 750 Series	Y45	46 Series
YHN450	0.522 - 0.743	4/0 - 400	4/0 (6/1) - 397.5 (18/1)	0.522 - 0.743	336 - 477	4/0 - 400	4/0 (6/1) - 397.5 (18/1)	1.86	3.50	1.25	U-N (3)	S-N (3)	P-N (3)
YHN500	0.522 - 0.814	4/0 - 500	4/0 (6/1) - 477.0 (18/1)	0.162 - 0.447	#6 - 3/0	#6 - 2/0	#6 (6/1) - 2/0 (6/1)	1.96	1.62	1.28	U-N (2)	S-N (2)	P-N (2)
YHN525	0.522 - 0.814	4/0 - 500	4/0 (6/1) - 477.0 (18/1)	0.522 - 0.814	-	4/0 - 500	4/0 (6/1) - 477.0 (18/1)	1.82	4.50	1.23	U-N (3)	S-N (3)	P-N (3)
YHN550	0.573 - 0.814	250 - 500	266.8 (18/1) - 477.0 (18/1)	0.410 - 0.563	3/0 - 300	2/0 - 4/0	2/0 (6/1) - 4/0 (6/1)	1.90	2.00	1.28	U-N (2)	S-N (2)	P-N (2)
YHN600	0.573 - 0.814	250 - 500	266.8 (18/1) - 477.0 (18/1)	0.574 - 0.684	336 - 400	250 - 350	266.8 (18/1) - 336.4 (18/1)	2.00	3.50	1.28	U-N (3)	S-N (3)	P-N (3)

Compact Conductors							Installation Data			
Catalog Number	Groove A (Run)			Groove B (Tap)			Die Index	Tool, Die Set Catalog No. & (# of Crimps)		
	Wire Diameter Range	Compact ACSR	Compact CU or AL	Wire Diameter Range	Compact ACSR	Compact CU or AL		35 and 750 Series	Y45	46 Series
YHN450	0.522 - 0.743	266.8 - 477	250 - 500	0.522 - 0.743	266.8 - 477	250 - 500	N	UN (3)	SN (3)	PN (3)
YHN500	0.522 - 0.814	266.8 - 556.5	250 - 556	0.162 - 0.447	#6 - 2/0	#6 - 3/0	N	UN (2)	SN (2)	PN (2)
YHN525	0.522 - 0.814	266.8 - 556.5	250 - 556	0.522 - 0.814	266.8 - 556.5	250 - 556	N	UN (3)	SN (3)	PN (3)
YHN550	0.573 - 0.814	300 - 556.5	300 - 556	0.410 - 0.563	2/0 - 266.8	3/0 - 266.8	N	UN (2)	SN (2)	PN (2)
YHN600**	0.573 - 0.814	300 - 556.5	300 - 556	0.574 - 0.684	300 - 397.5	300 - 397.5	N	UN (3)	SN (3)	PN (3)

R Die Connectors*												
Catalog Number	Conductors (See Below for Compact Conductors)							Dimensions			Tool, Die Set Catalog No. & (# of Crimps)	
	Groove A (Run)			Groove B (Tap)							Y45	46 Series
	Wire Diameter Range	Str.	ACSR	Wire Diameter Range	Sol.	Str.	ACSR	H	L	W		
YHR700	.666 - .893	336 - 600	300 - 556 (18/1)	.398 - .684	3/0 - 350	2/0 - 350	1/0 - 336.4 (18/1)	3.04	3.50	1.74	SKR (3)	PKR (3)
YHR750	.666 - .893	336 - 600	300 - 556 (18/1)	.666 - .893	N/A	350 - 600	300 - 556 (18/1)	3.04	4.62	1.74	SKR (4)	PKR (4)
YHR800	.879 - 1.108	600 - 900	556.5 (18/1) - 795 (26/7)	.398 - .684	3/0 - 350	2/0 - 350	1/0 - 336.4 (18/1)	3.05	3.50	1.74	SKR (3)	PKR (3)
YHR850	.879 - 1.108	600 - 900	556.5 (18/1) - 795 (26/7)	.666 - .893	N/A	350 - 600	300 - 556 (18/1)	3.04	4.62	1.74	SKR (4)	PKR (4)
YHR900	.879 - 1.108	600 - 900	556.5 (18/1) - 795 (26/7)	.879 - 1.108	N/A	600 - 900	556.5 (18/1) - 795 (26/7)	2.97	4.62	1.74	SKR (4)	PKR (4)
YHR950	.666 - 1.165	336 - 1000	336.4 (18/1) - 954 (45/7)	.666 - 1.165	N/A	336 - 1000	336.4 (18/1) - 954 (45/7)	3.14	6.00	1.66	SKR (5)	PKR (5)

Compact Conductors							Installation Data		
Catalog Number	Groove A (Run)			Groove B (Run)			Die Index	Tool, Die Set Catalog No. & (# of Crimps)	
	Wire Diameter Range	Comp. ACSR	Compact CU or AL	Wire Diameter Range	Comp. ACSR	Compact CU or AL		Y45	46 Series
YHR700	.666 - .893	397 - 636	477 - 636	.398 - .684	2/0 - 397 (18/1)	3/0 - 397.5	KR	SKR (3)	PKR (3)
YHR750	.666 - .893	397 - 636	477 - 636	.666 - .893	397 - 636	477 - 636	KR	SKR (4)	PKR (4)
YHR800	.879 - 1.108	795 - 954	795 - 954	.398 - .684	2/0 - 397 (18/1)	3/0 - 397.5	KR	SKR (3)	PKR (3)
YHR850	.879 - 1.108	795 - 954	795 - 954	.666 - .893	397 - 636	477 - 636	KR	SKR (4)	PKR (4)
YHR900	.879 - 1.108	795 - 954	795 - 954	.879 - 1.108	795 - 954	795 - 954	KR	SKR (4)	PKR (4)
YHR950	.666 - 1.165	-	-	.666 - 1.165	N/A	-	KR	SKR (5)	PKR (5)

* HYCRIMP™ connectors can be installed with competitor R dies.
 ** Die Index ST and SZ may also be used on sizes 700 - 900 only. SKR required for 950 and S-Z.
 For faster installations use BURNDY® PATRIOT® family of battery tools.
 Not recommended for copper to copper applications. Use a copper connector to increase connection life.

LOKTAP™ Connector, Types YHO, YHD For Aluminum, Copper

LOKTAP™ compression connectors are high quality, range-taking devices which accommodate combinations of aluminum to copper, and aluminum to aluminum conductors. BURNDY® seven connector program accommodates a conductor range from #6 Solid to 4/0 ACSR. In addition, LOKTAP™ connectors are designed to be installed with BURNDY® mechanical or hydraulic tools and matching O and D3 die set.

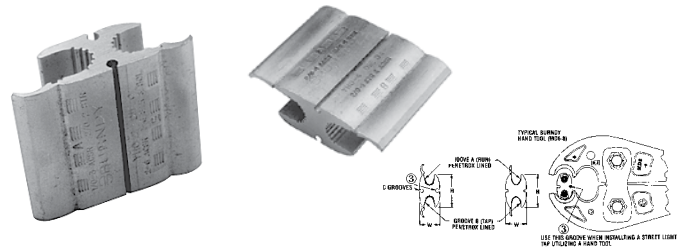

Handtool or Hydraulic 7 Connector Program ①														
Catalog Number	① Code No.	Conductors (See Below for Compact Conductors)								Dimensions			Installation Data Tool, Die Set Catalog No. & (# of Crimps)	
		Groove A (Run)				Groove B (Tap)								
		Wire Diameter Range	Sol.	Str.	ACSR	Wire Diameter Range	Sol.	Str.	ACSR	H	L	W	② MD7, MD6	35, 750 Series Y45†, 46†
YHO1	1	0.162 - 0.328	#6 - #1	#6 - #1	#6 - #2	0.162 - 0.328	#6 - #1	#6 - #1	#6 - #2	1.11	1.25	0.67	(4)	UO (2)
YHO2	2	0.260 - 0.419	#1 - 2/0	3 - 2/0	#3 - 1/0	0.162 - 0.332	#6 - 1/0	#6 - #1	#6 - #2	1.12	1.50	0.64	(5)	UO (2)
YHD3	3	0.398 - 0.470	3/0 - 4/0	2/0 - 3/0	1/0 - 2/0	0.162 - 0.332	#6 - 1/0	#6 - #1	#6 - #2	1.47	1.88	0.76	(5)	UD3 (2)
YHD4	4	0.336 - 0.470	2/0 - 4/0	1 - 3/0	#1 - 2/0	0.336 - 0.477	2/0 - 3/0	#1 - 2/0	#1 - 2/0	1.42	1.88	0.83	(5)	UD3 (2)
YHD5	5	0.475 - 0.563	250 - 300	4/0	3/0 - 4/0	0.162 - 0.332	#6 - 1/0	#6 - #1	#6 - #2	1.47	1.88	0.87	(5)	UD3 (2)
YHD6	6	0.461 - 0.563	250 - 300	3/0 - 4/0	3/0 - 4/0	0.336 - 0.447	2/0 - 3/0	#1 - 2/0	#1 - 2/0	1.42	2.25	0.83	(6)	UD3 (3)
YHD7	7	0.461 - 0.563	250 - 300	250 - 300	3/0 - 4/0	0.461 - 0.563	200 - 300	3/0 - 4/0	3/0 - 4/0	1.40	2.52	0.84	(7)	UD3 (3)

Compact Conductors								Installation Data		
Catalog Number	① Code No.	Groove A (Run)			Groove B (Tap)			Tool Series, Die Set Catalog No. & (# of Crimps)		Die Index
		Wire Diameter Range	Compact ACSR	Compact CU or AL	Wire Diameter Range	Compact ACSR	Compact CU or AL	② MD7, MD6	35, 750, Y45†, 46†	
YHO1	1	0.162 - 0.328	#6 - #1	#6 - #1	0.162 - 0.328	#6 - #1	#6 - #1	(4)	UO (2)	O
YHO2	2	0.260 - 0.419	#2 - 1/0	#2 - 2/0	0.162 - 0.332	#6 - #1	#6 - #1	(5)	UO (2)	O
YHD3	3	0.398 - 0.470	2/0 - 3/0	3/0	0.162 - 0.332	#6 - #1	#6 - #1	(5)	UD3 (2)	D3
YHD4	4	0.336 - 0.470	1/0 - 3/0	1/0 - 3/0	0.338 - 0.447	1/0 - 2/0	1/0 - 3/0	(5)	UD3 (2)	D3
YHD5	5	0.475 - 0.563	4/0 - 266	4/0 - 266	0.162 - 0.332	#6 - #1	#6 - #1	(5)	UD3 (2)	D3
YHD6	6	0.461 - 0.563	3/0 - 266.8	4/0 - 266	0.338 - 0.447	1/0 - 2/0	1/0 - 3/0	(6)	UD3 (3)	D3
YHD7	7	0.461 - 0.563	3/0 - 266.8	4/0 - 266	0.461 - 0.563	3/0 - 266.8	4/0 - 266	(7)	UD3 (3)	D3

Handtool or Hydraulic 4 Connector Program													
Catalog Number	Conductors (See Below for Compact Conductors)								Dimensions			Installation Data Tool, Die Set Catalog No. & (# of Crimps)	
	Groove A (Run)				Groove B (Tap)								
	Wire Dia. Range	Sol.	Str.	ACSR	Wire Dia. Range	Sol.	Str.	ACSR	H	L	W	35, 750, Y45†, 46†	
YHO125	0.162 - 0.398	#6 - 2/0	#6 - 1/0	#6 - 1/0	.162 - .332	#6 - 1/0	#6 - #1, 19 Str.	#6 - #2	1.15	1.62	0.70	UO (2)	
YHD5	0.475 - 0.563	250 - 300	4/0	3/0 (6/1) - 4/0 (6/1)	0.162 - 0.332	#6 - 2	#6 - 1/0	#6 - #1	1.47	1.88	0.87	UD3 (2)	
YHD6	0.461 - 0.563	250 - 300	3/0 - 4/0	3/0 (6/1) - 4/0 (6/1)	0.336 - 0.447	#1 - 2/0	2/0 - 3/0	#1 - 2/0	1.42	2.25	0.83	UD3 (3)	
YHD7	0.461 - 0.563	250 - 300	250 - 300	3/0 (6/1) - 4/0 (6/1)	0.461 - 0.563	3/0 - 4/0	200 - 300	3/0 - 4/0	1.40	2.52	0.84	UD3 (3)	

Compact Conductors							Installation Data	
Catalog Number	Groove A (Run)			Groove B (Tap)			Tool, Die Set No. & (# of Crimps)	Die Index
	Wire Dia. Range	Compact ACSR	Compact CU or AL	Wire Dia. Range	Compact ACSR	Compact CU or AL		
YHO125	0.162 - 0.398	#6 - 2/0	#6 - 1/0	.126 - .332	#6 - #1	#6 - #1	UO (2)	O
YHD5	0.475 - 0.563	4/0 - 266	4/0 - 266	.162 - 0.332	#6 - #1	#6 - #1	UD3 (2)	D3
YHD6	0.461 - 0.563	3/0 - 266.8	4/0 - 266	.338 - 0.447	1/0 - 2/0	1/0 - 3/0	UD3 (3)	D3
YHD7	0.461 - 0.563	3/0 - 266.8	4/0 - 266	.461 - 0.563	3/0 - 266.8	4/0 - 266	UD3 (3)	D3

① See page H-27 for Seven Connector Selector Chart.
 ② PERMANENT DIES IN TOOL INSTALL ALL SIZES.
 ③ "C" grooves accommodate #10 Sol.-#14 Sol. range, .116"-.064". No "C" grooves on Cat. #YHO125. When utilizing "C" groove(s) apply PENETROX™ A13 prior to wire installation. If utilizing two (2) "C" groove taps, installation to be made with HYDRAULIC TOOL ONLY. All four (4) grooves CANNOT be utilized if using a hand tool. When hand tool is used, only one (1) "C" groove can be used; connector MUST be positioned as shown in drawing.

† U Die with adapter PT651S.
 ‡ U Die with adapter PUADP1.

HYTEE™ T-Tap Connector, Type YCT For Copper

Material: Tin Plated Copper

One-piece, copper compression tap connector with U-shaped run element and tubular tap for joining hard and medium-hard drawn copper. Preformed run element simplifies installation on larger conductors. Uses same die as equivalent full-tension sleeve.

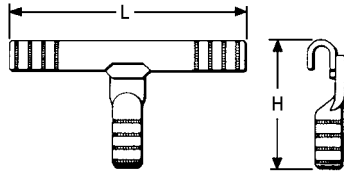

Conductors			H	L	Die Index	Run	Tap		
Catalog Number	Run	Tap				Tool Series, Die Set Catalog Number, & (Crimps per End)			
						MD7, MD6	35, 750, Y45 †, 46 ‡	MD6	35, 750, Y45 †, 46 ‡
YCT2626	2/0 (7, 12, 19)	2/0 (7, 12, 19)	3.26"	5.62"	166	W166 (4)	U166/U459 (2)	W166 (6)	U-166 (3)
YCT2828	4/0 (7, 12, 19)	4/0 (7, 12, 19)	4.00"	5.72"	168	—	U168(2)	—	U-168 (3)

† U Die with adapter PT6515.

‡ U Die with adapter PUADP1.

For faster installations use BURNDY® PATRIOT® family of battery tools, dies and cutters.



T-Tap Connector, Type YTU-R-R

For Copper, AAC (Stranded, Compressed, Compact),
ACSR, AAAC

Material: Aluminum

One-piece heavy-wall aluminum compression tap connector for secondary service drop and transformer tap to primary or secondary. Connector can be gripped in tool for easy installation. Pre-filled with PENETROX™ joint compound, stripsealed and capped to limit oxide growth and to increase the life of the connection.

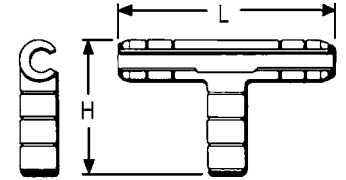

Catalog Number	Run			Tap			H	L	Tool Series, Die Set Catalog Number, & (Crimps per End)					
	ACSR, 6201, 5005	Aluminum	Copper	ACSR, 6201, 5005	Aluminum	Copper			Run			Tap		
									Die Index	MD7, MD6	35, 750, Y45†, 46 Series‡	Die Index	MD7, MD6	35, 750, Y45, 46 Series‡
YTU25R4W	1/0 80 (8-1)	1/0 (7, 19)	1/0 (7, 12, 19)	#6	#4 (7) #4 SLD	#4 (7) #4 Sol.	2-3/8	4-7/8	C	WC (2)	UC (1)*	BG	BG (3) WBG (1)*	UBG (1)*
YTU25R25R			1/0 80 (8-1)	—	—	—								
YTU26R26R	2/0	2/0 (7, 19)	2/0 (7, 12, 19)	2/0	2/0 (7, 19)	2/0 (7, 12, 19)	3-3/8	7	L	WL (4)	UL (2)	L	—	UL (2)
YTU27R27R	3/0	3/0 (7, 19)	3/0 (7, 12, 19)	3/0	3/0 (7, 19)	3/0 (7, 12, 19)								
YTU28R28R	4/0	4/0 (7, 19)	4/0 (7, 12, 19)	4/0	4/0 (7, 19)	4/0 (7, 12, 19)								
YTU30R30R	266.8 (18-1, 26-7, 6-7)	266.7 (7, 19, 37) 250 (19, 37) 300 (19, 37)	250 (12, 19, 37) 300 (19, 37)	266.8 (18-1, 26-7, 6-7)	266.7 (7, 19, 37) 250 (19, 37) 300 (19, 37)	250 (12, 19, 37)	4-3/8	8-3/4	M	—	UM (3)	M	—	UM (3)
YTU321R26R	300 (26-7) 336.4 (18-1)	350 (19, 37) 336.4 (19, 37)	350 (19, 37)	2/0	2/0 (7, 19)	2/0 (7, 12, 19)	3-1/2	8-5/8	M			L	—	UL (2)
YTU321R27R				3/0	3/0 (7, 19)	3/0 (7, 12, 19)			M			—	UL (2)	
YTU321R28R				4/0	4/0 (7, 19)	4/0 (7, 12, 19)			M			—	UM (3)	
YTU321R321R				336.4 (18-1) 300 (26-7)	336.4 (19, 37) 350 (19, 37)	350 (19, 37)			—			—	M	—
YTU33R26R	336.4 (30.7) (26-7) 400 (19, 37)	397.5 (19, 37) 400 (19, 37)	400 (19, 37)	2/0	2/0 (7, 19)	2/0 (7, 12, 19)	3-1/2	8-5/8	M			L	—	UL (2)
YTU33R28R			4/0	4/0 (7, 19)	4/0 (7, 12, 19)	M			—			UL (2)		
YTU33R33R			400 (19, 37)	336.4 (30-7, 26-7) 397.5 (181)	397.5 (19, 37) 400 (19, 37)	400 (19, 37)			4-3/8			8-3/4	M	M

* Multiple crimp die set, makes more than one crimp per tool compression. Figure indicates number of compressions.

† U Die with adapter PT6515

‡ U Die with adapter PUADP1.

Not recommended for copper to copper applications. Use a copper connector to increase connection life.

For faster installations use
BURNDY® PATRIOT® family of
battery tools, dies and cutters.



Disconnectable T-Tap with Pad, Type YTA-R-2N

For Copper, AAC (Stranded, Compressed, Compact),
ACSR, AAAC

Material: Aluminum

Aluminum primary T-Tap connector with slotted tap pad designed for easy disconnecting of tap conductor. Tap pad accommodates compression terminals Types YKA-R-2N and YKA-A-2N and has positioning socket for proper alignment. On sizes larger than 336.4 ACSR, the Type YTA-R-2N run element has two piece interlocking key with lifting eye to simplify hotline installations. Catalog number does not include mating terminal.

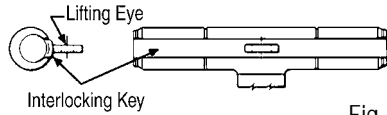
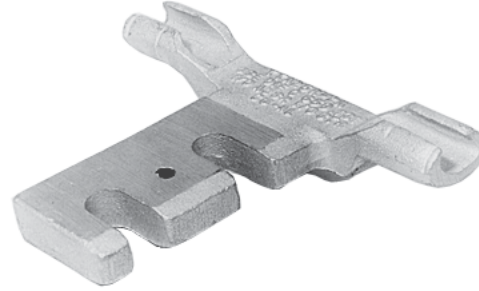

Fig. 2

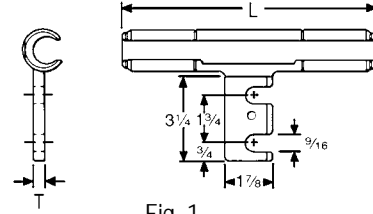

Fig. 1

Catalog Number	ACSR, 6201, 5005	Copper	Aluminum	Fig. No.	L	T	Die Index	Tool Series, Die Set Catalog Number, & (# of Crimps per End)				
								MD7, MD6	35, 750	Y45 †	46 ‡	60
YTA2R2N	2	2 (3, 7) 1 (7)	2 (7) 1 (7)	1	6-1/8	3/8	BG or 243	BG (2) W-BG (1)* W243 (2)	U- BG (1)* U243 (1)			
YTA25R2N	1/0	1/0 (7, 12, 19)	1/0 (7, 19)	1			247 C 659	W-C (4) W247 (1)	U659 (1) U-C (1) U247 (1)			
YTA26R2N	2/0	2/0 (7, 12, 19)	2/0 (7, 19)	1	7-7/8		L or 251	W-L (4)	U-L (2) U251 (3)			
YTA27R2N	3/0	3/0 (7, 12, 19)	3/0 (7, 19)	1								
YTA28R2N	4/0	4/0 (7, 12, 19)	4/0 (7, 19)	1								
YTA321R2N	300 (26-7) 336.4 (18-1)	350 (19, 37)	336.4 (19, 37, 61) 350 (19, 37, 61)	1	9-1/2	1/2	M		U-M (3) U317 (4)			
YTA33R2N	336.4 (26-7, 30-7) 397.5 (18-1)	400 (19, 37)	397.5 (19, 37, 61) 400 (19, 37, 61)	1								
YTA361R2N	477 (18-1)	—	—	2	13-1/8			—				
YTA37R2N	477 (24-7, 26-7, 30-7)	—	556.6 (19, 37)	2						U-M (5)		
YTA39R2N	556.5 (24-7, 26-7)	—	636 (37) 650 (61)	2	16-1/4				U608 (9)			L608 (3)
YTA43R2N	605 (30-19) 605 (30-9) 636 (24-7, 26-7, 30-19) 666.6 (24-7)	—	795 (37, 61)	2	16-1/2	3/4	292 or 319			S929 (9) S319 (9)	P929 (9) P319 (9)	L929 (9) P319 (9)
YTA391A2N	—	—	795 (37, 61)	2			342				S342 (9)	P342 (9)

* Multiple crimp die set, makes more than one crimp per tool compression. Figure indicates number of compressions.

† U Die with adapter PT6515.

‡ U Die with adapter PUADP1.

For faster installations use
BURNDY® PATRIOT® family of
battery tools, dies and cutters.



Disconnectable Terminal with Fixed Hardware Types YKA-R-2N, YKA-A-2N

For AAC (Stranded, Compressed, Compact), Copper, ACSR, AAAC

Material: Aluminum

Aluminum compression terminal with fixed hardware and positioning pin for making disconnectable tap or jumper connections. Used with slotted YTA-R-2N T-Tap or YSA-R-2N terminal. Supplied with aluminum bolts and washer-face, self locking nuts. Prefilled with PENETROX™ joint compound, capped, and stripsealed to limit oxide growth and to increase the life of the connection.

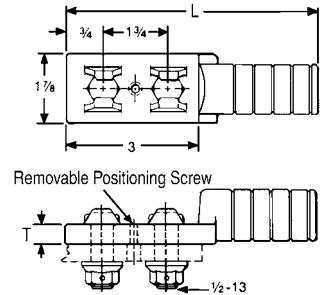

Catalog Number	ACSR, 6201, 5005	Copper	Aluminum	L	T	Bolt Length	Die Index	Tool Series, Die Set Catalog Number, & (Number of Crimps per End)						
								MD7, MD6	35, 750	Y45 †	46 ‡	60 Series		
YKA2R2N	2	1 (7) 2 (3, 7)	1 (7) 2 (7)	5-1/2	3/8	1-3/4	BG or 243	BG (8) WBG (4)* W243 (4)	UBG (3)* U243 (2)	—	—	—		
YKA25R2N	1/0	1/0 (7, 19)	1/0 (7, 19)	5-5/8			C or 659	WC (6)	UC (3)* U629 (2)	—	—	—		
YKA26R2N	2/0	2/0 (7, 19)	2/0 (7, 19)	6			3/8	1-3/4	L or 251	—	UL (2) U251 (3)	—	—	—
YKA27R2N	3/0 110.8 (12-7)	3/0 (7, 19)	3/0 (7, 19)											
YKA28R2N	4/0	4/0 (7, 19)	4/0 (7, 19)											
YKA30R2N	266.8 (18-1, 6-7, 26-7)	250 (12, 19, 37) 300 (19, 37)	250 (7, 37) 266 (19)	7-1/4			3/8	1-3/4	M or 317	—	UM (3) U317 (4)	—	—	—
YKA321R2N	336.4 (18-1) 300 (26-7)	350 (19, 37)	300 (37, 61) 350 (37, 61)											
YKA33R2N	336.4 (26-7, 30-7) 397.5 (18-1)	—	397.5 (19) 400 (37)											
YKA361R2N	397.5 (26-7, 30-7) 477 (18-1)	—	477 (19, 37) 500 (37, 61)											
YKA37R2N	477 (24-7, 26-7, 30-7)	—	556.5 (19, 37)	7-3/8			3/8	1-3/4	M	—	UM (3)	—	—	—
YKA34CA2N	397.5 (26-7, 30-7) 477 (18-1)	500 (19, 37)	477 (19, 37) 500 (37, 61)	—										
YKA391A2N	—	—	795 (37, 61)	9-1/2										
					3/4	2-1/2	342	—	—	S352 (6) S579 (6)	P352 (6) P579 (6)	L352 (9) L579 (9)		
								—	—	S342 (6)	P342 (6)	L342 (9)		

* Multiple crimp die set, makes more than one crimp per tool compression. Figure indicates number of compressions.

† U Die with adapter PT6515.

‡ U Die with adapter PUADP1.

For faster installations use
BURNDY® PATRIOT® family of
battery tools, dies and cutters.



Disconnectable Terminal with Slotted Pad, Type YSA-R-2N

For AAC (Stranded, Compressed, Compact), Copper, ACSR, AAAC

Material: Aluminum

Aluminum compression terminal with slotted pad and positioning socket for making disconnectable tap or jumper connections. Used with Type YKA-R-2N fixed hardware terminal. Pre-filled with PENETROX™ joint compound, stripsealed, and capped to limit oxide growth and to increase the life of the connection.

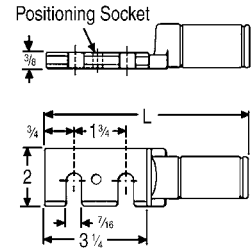

Catalog Number	ACSR, 6201, 5005	Copper	Aluminum	L	Die Index	Tool Series, Die Set Catalog Number, & (Number of Crimps)	
						MD7, MD8	35, 750, Y45 †, 46 ‡
YSA2R2N	2	2 (3, 7) 1 (7)	2 (7) 1 (7)	6-1/4	BG or 243	BG (8) WBG (4)* W243 (4)	UBG (3)* U243 (2)
YSA25R2N	1/0	1/0 (7, 19)	1/0 (7, 19)		C or 659	—	—
YSA26R2N	2/0	2/0 (7, 19)	2/0 (7, 19)	6-5/8	L or 251	—	UL U251
YSA28R2N	4/0	4/0 (7, 19)	4/0 (7, 19)				
YSA30R2N	266.8 (18-1, 6-7, 26-7)	250 (12, 19, 37) 300 (19, 37)	250 (37) 266.8 (7, 19)	7-3/4	M or 317	—	UM (3) U317 (4)
YSA321R2N	336.4 (18-1) 300 (26-7)	350 (19, 37)	300 (37, 61) 350 (37, 61)				
YSA37R2N	477 (24-7, 26-26-7, 30-7)	—	556.5 (19, 37)	7-7/8	M	—	UM (3)

* Multiple crimp die set, makes more than one crimp per tool compression. Figure indicates number of compressions.

† U Die with adapter PT6515.

‡ U Die with adapter PUADP1.

For faster installations use BURNDY® PATRIOT® family of battery tools, dies and cutters.



Disconnectable T-Tap, Type YTA-2N For Copper

Material: Copper

Cast copper primary T-Tap connector with slotted tap pad for easy disconnecting of tap conductor. Tap pad accommodates compression terminal Type YKA-2N. On sizes larger than 4/0, the YTA-2N run element has a two-piece, interlocking key with lifting eye that simplifies hot installations. Catalog number does not include terminal or hardware.

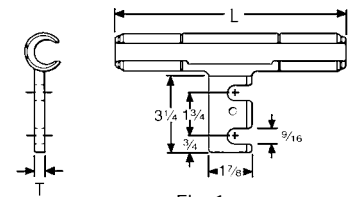
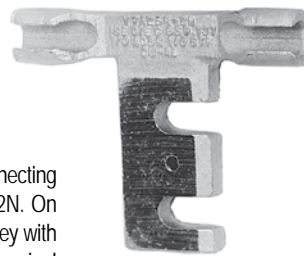

Fig. 1

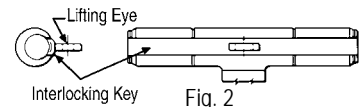

Fig. 2

Catalog Number	Conductor	Fig. No.	C	L	T	Die Index	Tool Series, Die Set Catalog Number, & (Number of Crimps)		
							MD7, MD6	35, 750, Y45, 46	60
YTA2C2N	2 (7)	1	1-1/2	5-5/8	3/8	163	W163 (3) Crimps Overlap	U163 (1)*	—
YTA262N	2/0 (7, 19)			7-3/8		166	W166 (6)	U166 (3)	—
YTA282N	4/0 (7, 12, 19)			7-5/8		168	—	U168 (4)	—
YTA342N	500 (19, 37, 61)	2	2	11-7/8	1/2	210	—	U210 (6)	L210 (2)

* Multiple crimp die set, makes more than one crimp per tool compression. Figure indicates number of compressions.

† U Die with adapter PT6515.

‡ U Die with adapter PUADP1.

For faster installations use BURNDY® PATRIOT® family of battery tools, dies and cutters.



Disconnectable Terminal with Fixed Hardware Type YKA-R-2N

For Copper

Material: Tin Plated Copper

Tin-plated copper compression terminal with fixed hardware for making disconnectable tap or jumper connections. Used with slotted Type YTA-2N T-tap or Type YSA-R-2N terminal. Supplied with tin-plated DURIMUM™ bolts and washer-face nuts.

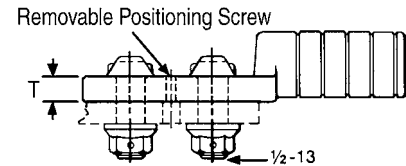
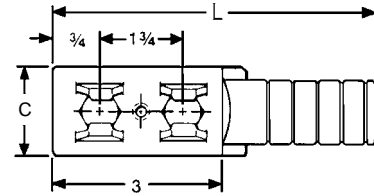

Catalog Number	Conductor	C	L	T	Die Index	Tool Series, Die Set Catalog Number, & (Number of Crimps)		
						MD7, MD6	35, 750, Y45†, 46‡	60 Series
YKA6C2N	6 (7)	7/8	5	3/8	163	W163 (2) Crimps Overlap	U163 (1)*	—
YKA2C2N	2 (7)							
YKA262N	2/0 (7, 19, 37)	1	5-1/4	1/4	166	W166 (4)	U166 (3)	
YKA282N	4/0 (7, 12, 19, 37)	1-1/4	5-3/8	3/8	168	—	U168 (3)	L168 (1)
YKA302N	300 (19, 37, 61)	1-1/2	5-1/2		170		U170 (5)	L170 (1)
YKA342N	500 (19, 37, 61)	1-7/8	6-1/2	210	U210 (6)		L210 (2)	
YKA442N	1000 (61)	2	7-5/8	345	—		L345 (4)	

* Multiple crimp die set, makes more than one crimp per tool compression. Figure indicates number of compressions.

† U Die with adapter PT6515.

‡ U Die with adapter PUADP1.

For faster installations use
BURNDY® PATRIOT® family of
battery tools, dies and cutters.



STIRRUP™ Hot-Line Clamp Adapters, Type YCB-R For AAC (Stranded, Compressed, Compact), ACSR, AAAC

Material: Aluminum; Tin Plated Copper Bail

Permanent compression hot-line clamp adapter with aluminum run and copper bail. Accommodates any standard copper hot-line clamp on bail elements. Permits hot-line tapping without arcing or chafing damage to aluminum conductor. Installed with standard tools and dies. Prefilled with PENETROX™ joint compound and stripsealed to limit oxide growth and increase the life of the connection.

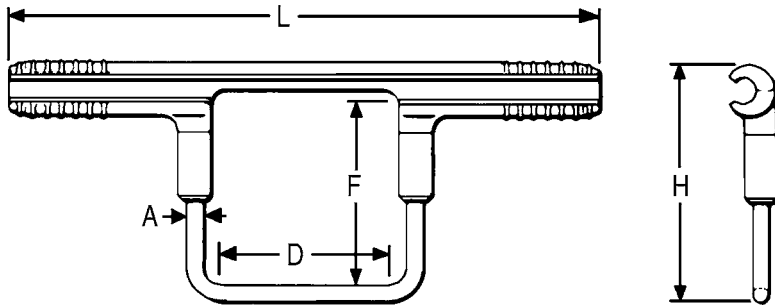

Catalog Number	Aluminum	ACSR, 6201, 5005	A	H	L	D	F	Die Index	Tool Series, Die Set Catalog Number, & (Crimps per End)	
									MD7, MD6	35, 750, Y45 †, 46 ‡
YCB2R	2 Str. - 6 Sol.	2-4	2 Sol.	3-3/4	9	2-1/2	2-1/2	BG	BG (6) WBG (2)*	UBG (2)*
YCB25R	1/0 (7, 19)	1/0 - 80 (8-1)	2 Sol.	5	9-3/4	2-1/2	3-1/2	C	WC (4)	UC (2)*
YCB26R	2/0 (7, 19)	2/0	1/0 Sol.	5	11-1/8	3-1/2	3-1/2	L	WL (4)	UL (2)
YCB27R	3/0 (7, 19)	3/0	1/0 Sol.	5	11-1/8	3-1/2	3-1/2	L	WL (4)	UL (2)
YCB28R	4/0 (7, 19)	4/0	1/0 Sol.	5	11-1/8	3-1/2	3-1/2	L	WL (4)	UL (2)
YCB321R	350 (19, 37) 336.4 (19, 37)	336.4 (18-1) 300 (26-7)	1/0 Sol.	5-3/8	12-3/4	3-1/2	3-1/2	M	—	UM (3)
YCB33R	400 (19, 37) 397.5 (19, 37)	336.4 (26-4, 30-7) 397.5 (18-1)	1/0 Sol.	5-3/8	12-3/4	3-1/2	3-1/2	M	—	UM (3)
YCB35R	500 (37, 61) 477 (19, 37)	397.5 (26-7) (30-7)	1/0 Sol.	5-3/8	12-3/4	3-1/2	3-1/2	M	—	UM (3)
YCB361R	477 (19, 37)	477 (18-1)	1/0 Sol.	5-1/4	13-1/4	3-1/2	3-1/2	317	—	U317 (3)

* Multiple crimp die set, makes more than one crimp per tool compression. Figure indicates number of compressions.

† U Die with adapter PT6515.

‡ U Die with adapter PUADP1.

For faster installations use
BURNDY® PATRIOT® family of
battery tools, dies and cutters.



CRIMPIT™ STIRRUP™, Types YCB-U, YCB-R-U

For AAC (Stranded, Compressed, Compact), ACSR, AAAC

Material: Aluminum

Tension Rating: ANSI C119.4 Class 3 (Non Tension)

Combines Figure 6-shaped aluminum CRIMPIT™ tap connector with tin-plated copper bail. Can be gripped in tool and slipped over line for easy installation. Five sizes accept a range from #4 to 600 kcmil. Prefilled with PENETROX™ joint compound and stripealed to limit oxide growth and to increase the life of the connection.

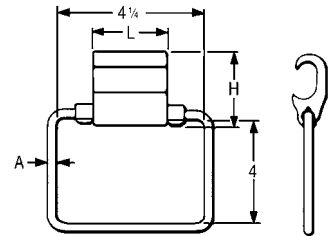

Catalog Number	Aluminum	ACSR, 6201, 5005	A	H	L	Die Index	Tool Series, Die Set Catalog Number, & (Number of Crimps)			
							35, 750	Y45	46	
YCB4U1	4 Sol. - 4 (7)	4	2 Sol.	1-1/2	1-7/8	D	UD (2)	†	‡	
YCB1U1	2 (7) - 1 (7)	2		1-5/8						
YCB28U26	1/0 (7) - 4/0 (19)	1/0 - 4/0		2	2-1/8	2-1/8	H	UH (2)		
YCB33R26U	300 (37) - 400 (37)	266.8 (6-7) - 336.4 (30-7)	1/0 Sol.	2-1/4			R	UR (2)		
YCB38R26U	397.5 (19) - 600 (61)	336.4 (26-7) - 556.5 (18-1)					N	UN (2)	SN (2)	PN (2)

* Index number "D" is not "D3" Cabelok CRIMPIT™ die.

† U Die with adapter PT6515

‡ U Die with adapter PUADP1.

For faster installations use BURNDY® PATRIOT® family of battery tools, dies and cutters.



Hot-Line Clamp Bails, Types J990, J1252

Material: Tin Plated Copper

Designed to make hot-line clamp adapter using HYCRIMP™, CABELOK™ CRIMPIT™ or Figure 6-shaped CRIMPIT™ connectors. Where hot sticks are used, the CABELOK™ CRIMPIT™ or Figure 6-shaped CRIMPIT™ are recommended. The line can be approached with the connector and bail held in the tool. Bails are tin-plated, hard drawn copper.

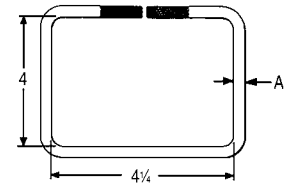

Recommended Connector & Bail Combinations						
HYCRIMP™ Cat. No.	CABELOK™ CRIMPIT™ Cat. No.	Bail Cat. No.	A	Run Conductors Accommodated		
				Sol. Al	Str. Al	ACSR
YHO100	YP2U3	J990	#2	6 - 2	6 - 3 (7 Str.)	6,4
YHO150	YP26AU2			1 - 2/0	3 (3 Str.) - 1/0	3 - 1/0
YHD200	YP27AU4			3/0 - 4/0	2/0 - 3/0	1/0, 2/0
YHD250	YPC28U4			—	4/0	3/0, 4/0
YHD300	YP27AU26	J1252	2/0	3/0	2/0, 3/0	2/0
YHD350	YP28U26			—	4/0	3/0, 4/0
—	YPC28U26	J990	#2	—	1/0 (7) - 4/0	1/0 - 4/0
		J1252	2/0			
YHN500	YPC33R26U	J990	#2	—	250 (37)	266.8 (18-1)
		J1252	2/0			

* For additional run & tap conductors see specific connector catalog page.

Overhead Distribution

Compression Tap (with Bail)
HYCRIMP™ STIRRUP™ Types YHO-J, YHD-J, YHN-J

HYCRIMP™ STIRRUP™ Tap Connectors with Bail, Types YHO-J, YHD-J, YHN-J

For AAC (Stranded, Compressed, Compact), ACSR

Material: Aluminum; Tin Plated Copper Bail

Utilizes H-Frame Aluminum Tap Connectors along with tin-plated copper bail. Bendable tabs secure run and bail freeing the lineman's hands to work with the installation tool. Conductor grooves are prefilled with PENETROX™ joint compound and stripsealed to limit oxide growth and increase the life of the connection.

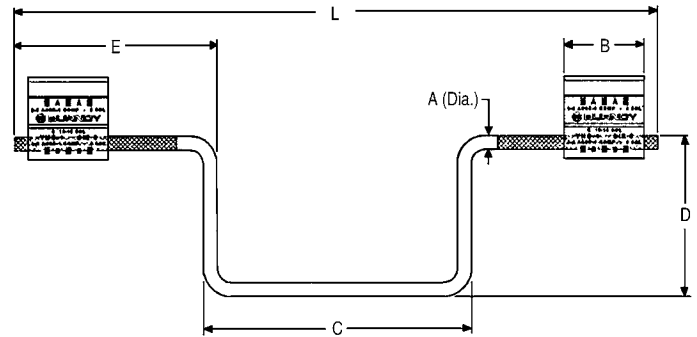

Catalog Number	Run Conductor Accommodates			A	B	C	D	E	L	Die Index	Tool Series, Die Set Catalog Number, & (# of Crimps)	
	Sol. Al	Str. Al	ACSR								① MD7-8 MD6-8	35, 750, Y45 †, 46 ‡
YHO100J1444	6-1	6-1 (7 Str.)	6-2	2 Sol. (0.258)	1.50	5.00	3.00	3.75	12.00	O	(4)	U-O (2)
YHO150J1444	1-2/0	3-2/0	3-1/0		1.75	5.00	3.00	3.75	12.00	O	(5)	U-O (2)
YHD200J1444	3/0 - 4/0	2/0 - 3/0	1/0 - 2/0		1.88	5.00	3.00	3.75	12.00	D3	(5)	UD-3 (2)
YHD250J1444	250 - 300	4/0	3/0 - 4/0		1.88	5.00	3.00	3.75	12.00	D3	(5)	UD-3 (2)
YHD300J1496	2/0 - 4/0	#1 - 3/0	#1 - 2/0	2/0 Sol. (0.365)	1.88	5.00	4.75	5.62	15.50	D3	(5)	UD-3 (2)
YHD350J1496	250 - 300	3/0 - 4/0	3/0 - 4/0		2.50	5.00	4.75	5.62	15.50	D3	(7)	UD-3 (2)
YHN500J1496	—	4/0 - 500	4/0 - 477 (18/1)		2.00	5.00	4.75	5.62	15.50	N	—	U-N (2)

① Permanent dies in tool install all sizes.

† U Die with adapter PT6515

‡ U Die with adapter PUADP1.

For faster installations use
BURNDY® PATRIOT® family of
battery tools, dies and cutters.



Transformer and Equipment Tap Connectors
General Overview

Transformer and equipment tap connectors are specifically designed to provide single or multi-tap connections from secondary transformer outlets, disconnects, circuit breaker panels, and other equipment pads or bar.

Transformer Tap Adapter, Type E-C-G
For Copper

Material: Copper

Tension Rating: ANSI C119.4 Class 3 (Non Tension)

Multi-tap, range-taking cast copper alloy connector designed to take 2, 3, or 4 conductors from a single secondary transformer outlet.

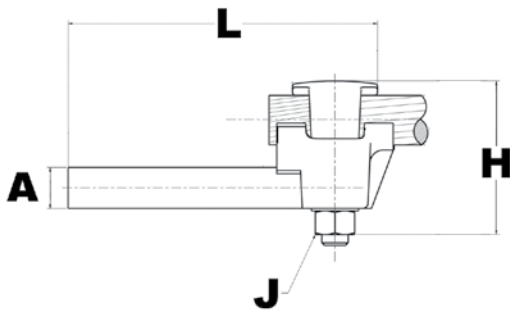

Fig.1

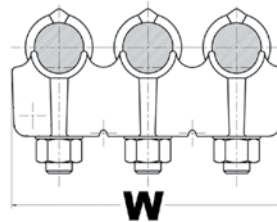

Fig.2

Catalog Number	Number of Conductors	Conductor Size	A dia.	D	H	J	L	W
E2C34G1	2	1/0 -500 kcmil	0.78	3-3/4	3-7/8	1/2 - 13	6 - 1/4	3-1/2
E3C34G1	3							5-1/4
E4C34G1	4							6-7/8

Overhead Distribution

Transformer Connectors
Types KC22J12T13, EOC632C; Type YA-2LH

Transformer Ground Connectors, Types KC22J12T13, EOC632C For Copper

Material: Copper

Fits all standard EEI-NEMA distribution transformers as tank grounding terminal.

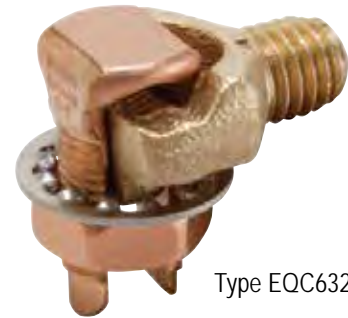

Type EOC632C

TYPE KC	Ranges
KC22J12T13	8 Sol. - 2 Sol.
KC26	2 Sol. - 2/0 Str.
KC34J12T13	3/0 - 500 Str.
EOC632C	8 Sol. - 2 Str.

Both, one-wrench installation.

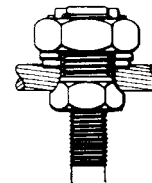

Type KC22B2

1/2-13
stud size

HYSEALUG™ Terminal with Shrouded Barrel, Type YA-2LH For Copper

Material: Copper

Tin-plated, pure copper 2-hole NEMA compression terminal with shrouded barrel for terminating insulated copper conductor to transformers and other equipment. Shroud prevents seepage of water or moisture into conductor strands and minimizes taping.

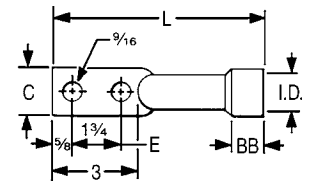
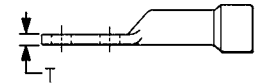

Catalog Number	Conductor	BB	Shroud Inside Diameter	C	L	T	Tool Series, Die Set Catalog Number, & (Number of Crimps)	
							MD7, MD6	35, 750, Y45 †, 46 ‡
YAB4C2LH72	4 Str.	5/8	0.57	3/4	6-1/4	1/8	W161 (2)	U4CRT (2)
YAB2C2LH74	2 Str.	3/4	0.58		6-1/2		W162 (4)	U2CRT (2)
YAB2C2LH75			0.91					
YAB252LH70	1/0 Str.	1	0.69	7/8	6-3/4	3/8	W163 (4)	U25RT (2)
YAB252LH71			0.98		6-1/4		W241 (2)	U26RT (2)
YA262LH89	2/0 Str.		1.04		6-1/4		—	W-BG or W243 (2)
YA282LH114	4/0 Str.		0.86	1	6-5/8	1/8	W166 (4)	U29RT (2)
YA282LH115			1.24				—	U30RT (2)
YA292LH91	250		1.25	1-1/8	1-1/4	7	W-0 (5)	U31RT (2)
YA302LH85	300	0.92	1-1/4	7-5/8		—	U34RT (2)	
YA312LH90	350	1.40	1-3/8					
YA342LH110	500	1-1/2	1.14	1-1/2	7-3/4	1/4	—	
YA342LH111			1.88				—	

† U Die with adapter PT6515

‡ U Die with adapter PUADP1.

For faster installations use BURNDY® PATRIOT® family of battery tools, dies and cutters.



HYSEALPLUG™ Transformer Pin Terminal, Type YE-LH

For Copper

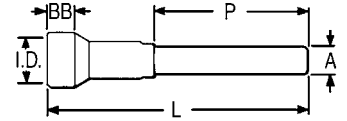

Material: Copper

Tension Rating: ANSI C119.4 Class 3 (Non Tension)

Oil and water-tight terminal with shrouded, tin-plated, copper barrel, and brazed plug. Recommended for terminating insulated copper conductor at cutout, transformer and arrester; or for joining insulated copper riser to overhead conductor. Shroud prevents seepage of water or moisture into conductor strands and minimizes taping. To obtain a tight fit on some insulations in the shroud it may be necessary to either "pencil" the insulation down, or build it up with tape.

Catalog Number	Conductor	BB	Shroud Inside Dia.	A Dia.	L	P	Tools, Die Set Catalog Number, & (# of Crimps)	
							MD6, MD7	35, 750, Y45 †, 46 ‡
YE2CLH128	2 Str.	3/4	0.58	2 Sol.	9	6	W162 (4)	U2CRT (2)
YE2CLH129			0.91					
YE25LH97	1/0 Str.	1	0.98	1/0 Sol.	11-1/8	8	W163 (4)	U25RT (2)
YE26LH88	2/0 Str.		0.73	2/0 Sol.	11-3/8		W241 (2)	U26RT (2)
YE26LH89			1.04				W241 (2)	
YE28LH128	4/0 Str.		1.24	4/0 Sol.	11-1/2		WBG or W243 (2)	U28RT (2)
YE31LH96	350	1.03	12-1/4			WO (5)	U31RT (2)	
YE34LH119	500	1.14	13-1/4			—	U34RT (2)	
YE34LH120		1.88						

† U Die with adapter PT6515.
 ‡ U Die with adapter PUADP1.

For faster installations use BURNDY® PATRIOT® family of battery tools, dies and cutters.



HYPLUG™ Pin Terminal, Types YE-R, YE-W

For AAC (Stranded, Compressed), ACSR, AAAC

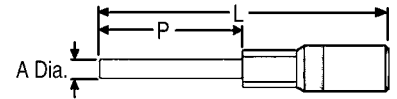
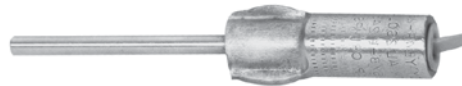

Material: Aluminum

Tension Rating: ANSI C119.4 Class 3 (Non Tension)

In 1989 BURNDY® began shipping an improved pin type connector. A proprietary coating system was developed through intense research efforts which vastly prolongs the life of this type of connection. To help identify the new product, a hex-shaped crimp is now used on the pin interface crimp and overhead color-coded end caps are utilized.

Aluminum HYPLUG™ with tin-plated copper plug for terminating aluminum or ACSR cable at cutout, transformer, and arrester. Plug may be bend to desired angle for easier insertion. Three die sets accommodate #4 Stranded to 500 kcmil. Prefilled with PENETROX™ A13 joint compound and sealed with color-coded end caps.

Catalog Number	Conductor		A Dia.	L	P	Color Code	Die Index	Tool Series, Die Set Catalog Number		
	Alum.	ACSR						MD7, MD6	35, 750, Y45 †, 46 ‡	60 Series
YE6R25	5, 6 Str.	6	4 Sol.	4-5/8	2-1/2	Blue	K-5/8-1, 243, BG, 8A	BG WBG W243	UBG U243 UK5/81T	L243
YE4R25	3, 4 Str.	4				Orange				
YE1WAG1	#1 Sol. (.289)	—	0.25	8.58 (218)	6	Red	K-5/8-1, 243, BG	BG WBG W243	UBG U243 UK5/81T	L243
YE2WAG5	#2 Sol. (.258)	—				Orange				
YE2R25	1, 2 Str.	2	2 Sol.	4-5/8	2-1/2	Red	K-5/8-1, 243, BG, 8A	W249 or WK840	U249 UK840T	L249
YE25R25	1/0 Str.	1/0				Yellow				
YE26R60	2/0 Str.	2/0	1/0 Sol.	9-1/2	6	Gray	249 840 11A	W249 or WK840	U249 UK840T	L249
YE27R60	3/0 Str.	3/0				Black				
YE28R60	4/0 Str.	4/0	3/8	10-5/8	6	Pink	317, 705, K-1-1/8-1	—	U317 U705 UK1181T	L317
YE30R60	300	266.8 (26/7) (18/1)	4/0 Sol.			Blue				
YE32R60	350-400	336.4 (26/7) (18/1)	4/0 Sol.			Green				
YE361R60	477, 500	477 (18/1)	9/16			Pink				
YE39R60	600	556.5 (24/7) (26/7)	5/8	11-7/8	6	Yellow	608	—	U608	L608

BURNDY® furnishes many special versions of YE-R including: pin length variations, factory applied pin angles, etc.

Contact your BURNDY® representative for your special needs.

* All crimps overlap
 †U Die with adapter PT6515.
 ‡U Die with adapter PUADP1.

For faster installations use BURNDY® PATRIOT® family of battery tools, dies and cutters.



Table of Contents

Compression Splices.....	H-45
Service Entrance	
Type ES.....	H-46
Type YSU.....	H-47
Type YSD.....	H-48
Neutral	
Types YSS, YCS-R, YDS-AT.....	H-49
Jumper	
Types YCS, YDS.....	H-50
Type YCU-A.....	H-50
Type YCS-R.....	H-51
Type YCS-RL.....	H-52
Type YCS-A.....	H-53
Type YCR.....	H-53
Type YCR-R-G.....	H-54
Repair Sleeve	
Types YCU-R, YOU-R.....	H-55
Type YCU-R for ACSR Static Wire.....	H-55
Types YDS-W, YDS.....	H-56
Full Tension	
Types YDS, YDS-C.....	H-57
Types YDS-A, YDS-AT.....	H-58
Types YDS-RL, YDS-LT.....	H-59
Type YDS-RLNI.....	H-61
Types YDS-A, YDS-AT.....	H-62
Type YDS-RLY.....	H-63
Types YDS-R SET, YDS-RP1, YDS-RP2.....	H-64
Types YDS-R, YDS-RE.....	H-66
Types YDS-E, YDS-H, YDS-U.....	H-66
Type YDSR-RL.....	H-67
Type YDR-R.....	H-68
Type YDS-K.....	H-69
Type YTS-E.....	H-69
Types YDS-KT, YDS-F.....	H-70
Type YDS-M-T.....	H-70

Most frequently ordered catalog numbers are highlighted in BLUE

Compression Splices General Overview

The BURNDY line of service, full-tension, and jumper sleeves provide a dependable, economical, and easy-to-install method of splicing overhead transmission and distribution lines.

A major part of the Total BURNDY® Compression Program, they are available for copper, aluminum, ACSR, COPPERWELD, ALUMOWELD, Steel, 6201, 5005, ACSR/AW, AWA, and compressed forms for aluminum and ACSR. Each is clearly marked with the installation Die Index number and knurls are provided which show the installer the correct number of crimps and the spacing required. Connections made with BURNDY® INSULINK™ and HYSPLICE™ sleeves have a lower resistance than an equal length of conductor.

HYSPLICE™ sleeves are tapered or chamfered at the ends; externally to provide gradual reduction of pressure on the conductor, and internally to facilitate conductor insertion.

Service Sleeve Design

Service entrance connectors are available insulated (INSULINK™) or uninsulated (LINKIT™). Both are installed with the one-hand OH25 and OUR840 HYTOOL™ or the MD6 HYTOOL™. The INSULINK™ features polyethylene caps which seal out dirt and moisture, and grip the cable insulation leaving both hands free for crimping. The aluminum insert is anchored to the nylon jacket so that it will not move when crimped, ensuring that the insert is always under the die. The jacket is color coded for easy identification of conductor size.

The aluminum LINKIT™ minimizes the effects of galvanic corrosion. It is designed for easy location of crimps, and is color coded.

The service HYSPLICE™ connectors are partial-tension sleeves for splicing the neutral conductor of triplex service. They are installed with MD6, OUR840 and the OH25 HYTOOL™ on aluminum and ACSR conductors from #6 to 1/0.

Copper HYSPLICE™ Sleeve Design

Full-tension holding strength and high conductivity of BURNDY® copper HYSPLICE™ sleeves are accomplished through the combined action of correct contact length, proper number of circular crimps of precisely controlled depth that perform a current carrying and keying function between the conductor and the sleeve.

Aluminum HYSPLICE™ Sleeve Design

HYSPLICE™ sleeves for aluminum conductor not only satisfy the basic tension requirements, but also deal with the problems of "cold flow" of aluminum and the oxide film which forms on the strands. "Cold flow" is compensated for by carefully coordinating the design of the sleeve and its associated installation die. To offset the effects of the non-conductive oxide film present on the surfaces of aluminum cable. BURNDY® HYSPLICE™ sleeves are pre-filled with PENETROX™ joint compound and capped or stripealed. A solid center barrier forces the PENETROX™ around the cable strands during insertion.

ACSR HYSPLICE™ Sleeve Design

Two-Piece, Full-tension HYSPLICE™

Two-piece, full-tension HYSPLICE™ for ACSR consists of an inner steel sleeve for joining the steel core, and an outer aluminum sleeve for connecting the aluminum strands. To install the two-piece HYSPLICE™, the cable is cut, the aluminum sleeve slid onto the cable, aluminum strands cut back and the steel sleeve installed. The aluminum sleeve is then centered over the steel sleeve, PENETROX™ joint compound injected (PENETROX™ is brushed on cable prior to centering aluminum sleeve on smaller sizes), and the sleeve is crimped.

Single-sleeve, Full-tension UNISPLICE™

The UNISPLICE™ is as easy to install as aluminum full-tension sleeves. The single, heavy walled aluminum sleeve is filled with a special inhibiting compound containing grit particles which key the steel strand in place. The UNISPLICE™ eliminates cutting back of aluminum strands, the need for a separate steel sleeve, and careful position of the aluminum outer sleeve before crimping.

Since the standard pull-out tests are inadequate for evaluating UNISPLICE™ performance, BURNDY® has developed the sustained-tension test that subjects a connector-conductor assembly to a 168 hour sustained load equal to 90% of the conductor strength. This test simulates a service life of 30-40 years at 60% of the conductor strength.

Jumper Sleeves

Since the holding strength required for jumper sleeves is less than that required for full-tension sleeves, the jumper HYSPLICE™ sleeve is shorter. Aluminum, ACSR, sleeves are pre-filled with PENETROX™ joint compound and installed with the same tools and dies as the full-tension sleeves.

INSULINK™ Service Entrance Splices, Type ES

For AAC (Stranded, Compressed, Compact**), Copper, ACSR, AAAC

Material: Aluminum (Insulated)

Pre-insulated service entrance compression connector installed with OH25, OUR840, and MD6 HYTOOL™ as well as the 35 and 750 HYPRESS™ tools. Polyethylene caps prevent dirt from accumulating in barrel, grip cable for easy two-hand installation, and seal out moisture. Aluminum connector is anchored to jacket, assuring the connector is under the die when crimping. Nylon jacket insulated connectors electrically and protects against water and weather. Superior color coding. Prefilled with PENETROX™ joint compound and stripsealed to limit oxidation and to increase the life of the connection. Do not use insulated sealed connectors on bare conductors, refer to LINKIT™ connectors.

For faster installations use BURNDY® PATRIOT® family of battery tools, dies and cutters.



RUS Accepted

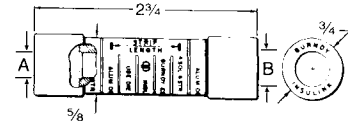

- Not for use on bare conductors.
- ▲ Accommodates 1/0 stranded aluminum and copper, concentric, compressed and compact conductors.
- ** Accommodates compact conductors where stated in the table.

Catalog Number	Side A ■			Side B ■			Die Index	Installation Tooling* (# of Crimps per End)			
	ACSR, 6201, 5005	Aluminum & Copper	Color Code	ACSR, 6201, 5005	Aluminum & Copper	Color Code		Dieless OH25	MD6/MD7 Series	OUR840	35, 750 Series
ES8W8W	—	10 Str. 8 Sol.	Brown	—	10 Str. 8 Sol.	Brown	BG or 5/8	(1)	WBG (1)*	XNBG (1)*	UBG (1)*
ES6W8W		8 Str. 6 Sol. #8 AL Compt	Green	—	8 Str. 6 Sol. #8 AL Compt	Green					
ES6W6W				—	10 Str. 8 Sol.	Brown					
ES4W8W	6	5, 6 Str. 4 Sol.	Blue	—	8 Str. 6 Sol. #8 AL Compt	Green					
ES4W6W				—	10 Str. 8 Sol.	Brown					
ES4W4W				6	5, 6 Str. 4 Sol.	Blue					
ES2W8W	4	3, 4 Str. 2 Sol.	Orange	—	8 Str. 6 Sol. #8 AL Compt	Green					
ES2W6W				—	10 Str. 8 Sol.	Brown					
ES2W4W				6	5, 6 Str. 4 Sol.	Blue					
ES2W2W				4	3, 4 Str. 2 Sol.	Orange					
ES2R8W	2	1 Str. 2 Str. #1 AL Compt #2 AL Compt	Red	—	8 Str. 6 Sol. #8 AL Compt	Green					
ES2R6W				—	10 Str. 8 Sol.	Brown					
ES2R4W				6	5, 6 Str. 4 Sol.	Blue					
ES2R2W				4	3, 4 Str. 2 Sol.	Orange					
ES2R2R				2	1 Str. 2 Str. #1 AL Compt #2 AL Compt	Red					
ES25R6W	1/0, 1	1/0 Str. 1-19 Str.	Yellow	—	8 Str. 6 Sol. #8 AL Compt	Green					
ES25R4W				6	5, 6 Str. 4 Sol.	Blue					
ES25R2W				4	3, 4 Str. 2 Sol.	Orange					
ES25R2R				2	2 Str. 1 Str. #1 AL Compt #2 AL Compt	Red					
ES25R25R				1/0, 1	1/0 Str.	Yellow					
ES25A25A	—	1/0 Str. ▲	Yellow	—	5, 6 Str. 4 Sol.	Blue					
ES25A4W	6			5, 6 Str. 4 Sol.	Blue						
ES25A2W	4			3, 4 Str. 2 Sol.	Orange						

5/8" LINKIT™ Service Entrance Splices, Type YSU

For AAC (Stranded, Compressed, Compact**), Copper, ACSR, AAAC

Material: Aluminum (Uninsulated)

Heavy-walled aluminum tubing with solid barrier minimizes galvanic corrosion of conductors. Accommodates neutral strands of Type SE Service Entrance conductor as well as other conductors. Installed with standard tooling. Color coded, prefilled with PENETROX™ joint compound and stripsealed to limit oxidation and increase the life of the connection.



RUS Accepted

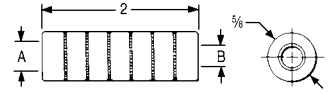

▲ Accommodates 1/0 standard aluminum and copper concentric, compressed and compact conductors.

** Accommodates compact conductors where stated in the table.

For faster installations use BURNDY® PATRIOT® family of battery tools, dies and cutters.



Catalog Number	Side A			Side B			Die Index	Installation Tooling* (# of Crimps per End)			
	ACSR, 6201, 5005	Aluminum & Copper	Color Code	ACSR, 6201, 5005	Aluminum & Copper	Color Code		Dieless OH25	MD6/MD7 Series	OUR840	35, 750 Series
YSU6W6W	—	8 Str. 6 Sol. #8 Al Compt	Green	—	8 Str. 6 Sol. #8 Al Compt	Green	243 BG or 5/8	(1)	WBG (1)*	XNBG (1)*	UBG (1)*
YSU4W8W	6	5, 6 Str. 4 Sol. #4 Al Compt	Blue	—	8 Sol. 10 Str.	Brown					
YSU4W6W				—	6 Sol. 8 Str. #8 Al Compt	Green					
YSU4W4W				6	5, 6 Str. 4 Sol. #4 Al Compt	Blue					
YSU2W8W				4	3, 4 Str. 2 Sol.	Orange					
YSU2W6W	—	6 Sol. 8 Str. #8 Al Compt	Green								
YSU2W4W	6	5, 6 Str. 4 Sol. #4 Al Compt	Blue								
YSU2W2W	4	3, 4 Str. 2 Sol.	Orange								
YSU2R8W	2	2 Str. 1 Str. #1 Al Compt #2 Al Compt	Red	—	8 Sol. 10 Str.	Brown					
YSU2R6W				—	6 Sol. 8 Str. #8 Al Compt	Green					
YSU2R4W				6	5, 6 Str. 4 Sol. #4 Al Compt	Blue					
YSU2R2W				4	3, 4 Str. 2 Sol.	Orange					
YSU2R2R				2	2 Str. 1 Str. #1 Al Compt #2 Al Compt	Red					
YSU25R6W	1/0	1/0 Str. 2/0 Al Compt 1/0 Al Compt	Yellow	—	8 Str. 6 Sol. #8 Al Compt	Green					
YSU25R4W				6	5, 6 Str. 4 Sol. #4 Al Compt	Blue					
YSU25R2W				4	3, 4 Str. 2 Sol.	Orange					
YSU25R2R				2	2 Str. 1 Str. #1 Al Compt #2 Al Compt	Red					
YSU25R25R				1/0	1/0 Str. 2/0 Al Compt 1/0 Al Compt	Yellow					
YSU25A25A	1-1	1/0 Str. ▲	Yellow	1/0	1/0 Str.	Yellow					

.840 LINKIT™ Service Entrance Splices, Type YSD

For AAC (Stranded, Compressed, Compact**), Copper, ACSR, AAAC

Material: Aluminum (Uninsulated)

Aluminum compression sleeve with solid center barrier. Designed for commercial and heavy residential services. Installed with standard tooling. Prefilled with PENETROX™ joint compound, capped and stripsealed to limit oxidation and to increase the life of the connection.

* Multiple crimp die set, makes more than one crimp per tool compression.

Figure indicates number of compressions.

** Accommodates compact conductors where stated in the table.



RUS Accepted

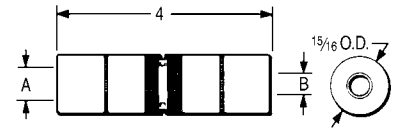

For faster installations use BURNDY® PATRIOT® family of battery tools, dies and cutters.



Catalog Number	Side A			Side B			Die Index	Installation Tooling *** (Number of Crimps per End)		
	ACSR 6201, 5005	Aluminum & Copper	Color Code	ACSR, 6201, 5005	Aluminum & Copper	Color Code		MD6/MD7 Series	OUR840	35, 750* Series
YSD25R25R	1/0	1/0 Str. 2/0 AL Compt	Yellow	1/0	1/0 2/0 AL Compt	Yellow	249 K840	WK840 (7) W249 (4)	X840 (7) X249 (8)	UK840 (4) U249 (2)
YSD26R2W	2/0	2/0 Str. 3/0 AL Compt	Gray	4	3, 4 Str. 2 Sol. #2 AL Compt	Orange				
YSD26R2R				2	2 Str. 1 Sol. 1/0 AL Compt	Red				
YSD26R25R				1/0	1/0 Str. 2/0 AL Compt	Yellow				
YSD26R26R				2/0	2/0 Str. 3/0 AL Compt	Gray				
YSD27R2W	3/0	3/0 Str. 4/0 AL Compt	Black	4	3, 4 Str. 2 Sol. #2 AL Compt	Orange				
YSD27R2R				2	2 Str. 1 Sol. 1/0 AL Compt	Red				
YSD27R25R				1/0	1/0 2/0 AL Compt	Yellow				
YSD27R26R				2/0	2/0 Str. 3/0 AL Compt	Gray				
YSD27R27R				3/0	3/0 Str. 4/0 AL Compt	Black				
YSD28R2W	4/0	4/0 Str. 300 AL Compt	Pink	4	3, 4 Str. 2 Sol. #2 AL Compt	Orange				
YSD28R2R				2	2 Str. 1 Sol. 1/0 AL Compt	Red				
YSD28R25R				1/0	1/0 2/0 AL Compt	Yellow				
YSD28R26R				2/0	2/0 Str. 3/0 AL Compt	Gray				
YSD28R27R				3/0	3/0 Str. 4/0 AL Compt	Black				
YSD28R28R				4/0	4/0 Str. 300 AL Compt	Pink				

HYSPLICE™ Service Entrance, Short Span Lines (Neutrals), Types YSS, YCS-R, YDS-AT

For AAC (Stranded, Compressed, Compact**), Copper, ACSR, AAAC

Material: Aluminum

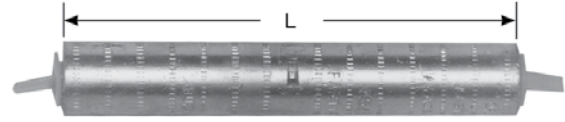

Single aluminum sleeve designed for service drop or short span overhead distribution lines. Installed with OH25 hand tool and other standard tooling. Prefilled with PENETROX™ joint compound and stripealed to limit oxidation and increase the life of the connection.

Catalog Number	Conductor	L	Die Index	Color Code	Tool Series, Die Set Catalog Number*** & (Crimps per End)		OH25 Applications	
					MD7, MD6	35, 750, Y45†, 46‡	Conductor	OH25 (Indents per End)
YSS6RG2	6 ACSR 4 Sol. Al	4.00	BG	Blue	BG (6) WBG (3)*	UBG (3)*	—	—
YSS6R	6 ACSR 4 Sol. Al	4.72	162	Blue	W162 (4)	U162 (2)*	—	—
YDS4WA	4 Sol. Al 4 Str. Al (7)	2-5/8	162	Orange	W162 (4)	U162 (1)*	—	—
YDS4CA								
YSS4R	4 ACSR 2 Sol. Al 4 Al (7)	3.78	BG or 5/8	Orange	BG (6) WBG (3)*	UBG (3)*	4 7 Al (3) 4 5005 Al (2) 4 5005 Al (3) 4 (6-1) ACSR (3) 4 (6-1) ACSR (2) 4 (7-1) ACSR (3) 4 (7-1) ACSR (2) 2 Sol. Al (3) 2 Sol. Al (2)	
YSS2R	2 ACSR 2 Al (7)	3.78	BG or 5/8	Red	BG (6) WBG (3)*	UBG (3)*	2 (6-1) ACSR (3) 2 (7-1) ACSR (3) 2 (7-1) ACSR (2) 2 7 Al (3)	
YDS25AT	1/0 (7)	7-1/4	243	Yellow	W243(6)	U243(3)	1/0 7 Al	(4)
YCS25R	1/0 ACSR	7.09	243	Yellow	BG (12) WBG (6)*	UBG (6)*	1/0 (6-1) ACSR 1/0 (6-1) ACSR	(2) (3)

* Multiple crimp die set; makes more than one crimp per tool compression. Figure indicates number of compressions.

** Accommodates compact conductors where stated in the table.

† U Die with adapter PT6515

‡ U Die with adapter PUADP1.

For faster installations use
 BURNDY® PATRIOT® family of
 battery tools, dies and cutters.



HYSPLICE™ Single Sleeve Jumpers, Types YCS, YDS For Copper

Material: Copper



Tension Rating: ANSI C119.4 Class 1A
(Normal Tension)

Loop HYSPLICE™ connector designed to withstand jumper loop tensile and vibration stresses up to 60% RBS. Made of pure copper tubing, installed with standard tools and dies.

RUS Accepted.

* Multiple crimp die set; makes more than one crimp per tool compression. Figure indicates number of compressions.

† U Die with adapter PT6515.

‡ U Die with adapter PUADP1.

For faster installations use BURNDY® PATRIOT® family of battery tools, dies and cutters.



Catalog Number	Conductor	L	Die Index	Tool Series, Die Set Catalog Number, & (Crimps per End)		
				MD7, MD6	35, 750, Y45†, 46‡	60
YDS8W	8 Sol.	1-5/8	171	W171 (1)	U171 (1)*	—
YDS6W	6 Sol.	2-5/8	161	W161 (2)	U161 (1)*	—
YDS4W	4 Sol.	2-1/2	162	W162 (4)	U162 (1)*	—
YDS2W	2 Sol.	3-3/4	163	W163 (6)	U163 (2)*	—
YDS6C	6 (7)	2-3/4	161	W161 (2)	U161 (1)*	—
YDS4C	4 (7)	2-5/8	162	W162 (4)	U162 (1)*	—
YDS2C	2 (7), 3 (3)	3-5/8	163	W163 (6)	U163 (2)*	—
YDS1C	1 (7, 19)	3-1/8	164	W164 (6)	U164 (3)*	—
YCS25	1/0 (7, 19)	3-3/8	165	W165 (3)	U165 (3)	—
YCS26	2/0 (7, 11, 12, 19)	3-3/8	166	W166 (6)	U166 (3)	—
YCS27	3/0 (7, 19)	3-1/4	167	—	U167 (3)	—
YCS28	4/0 (7, 12, 19)	3-1/8	168	—	U168 (3)	L168 (1)
YCS29	250 (7, 37, 19)	3-5/8	169	—	U169 (4)	L169 (2)
YCS30	300 (19, 37)	5-3/8	170	—	U170 (4)	L170 (1)
YCS31	350 (12, 19, 37)	5-3/8	267	—	U267 (6)	L267 (2)
YCS32	400 (19, 37)	5-3/4	209	—	U209 (6)	L209 (2)
YCS34	500 (19, 37)	5-1/8	210	—	U210 (6)	L210 (2)
YCS39	750 (37)	6-7/8	627	—	—	L627 (3)
YCS44	1000 (61, 37)	7-3/4	345	—	—	L345 (4)

Repair Sleeve, Type YCU-A

For AAC (Stranded, Compressed, Compact)

Material: Aluminum

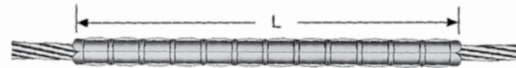

For restoring conductivity to damaged conductors. Made of cast aluminum. Use same die as equivalent full-tension sleeve. Use of PENETROX™ joint compound required.

Catalog Number	Conductor	L	Die Index	Tool Series, Die Set Catalog Number, & (Number of Crimps)				
				MD7, MD6	35, 750	Y45	46	60
YCU2CA	2 (7)	7-5/8	163	W163 (27)	U163 (9)*	†	‡	—
YCU25A	1/0 (7)	8-3/4	243	W243 (20)	U243 (10)	†	‡	—
YCU28A	4/0 (7, 19)	11-7/8	249	W249 (28)	U249 (14)	†	‡	L249 (7)
YCU291A	266.8 (7)	11-5/8	251	—	U251 (20)	†	‡	L251 (10)
YCU301A	336.4 (19,37)	11-5/8	321	—	U321 (20)	†	‡	L231 (10)

* Multiple crimp die set; makes more than one crimp per tool compression. Figure indicates number of compressions.

† U Die with adapter PT6515.

‡ U Die with adapter PUADP1.

For faster installations use BURNDY® PATRIOT® family of battery tools, dies and cutters.



HYSPLICE™ Single Sleeve Jumper, Type YCS-R

For AAC (Stranded, Compressed), ACSR, AAAC

Material: Aluminum

Tension Rating: ANSI C119.4 Class 2
 (Partial Tension)

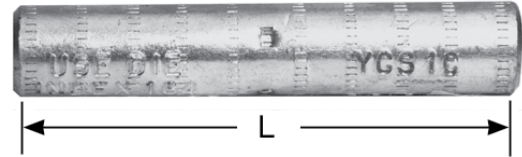

RUS Accepted

HYSPLICE™ sleeve designed to withstand jumper loop tensile and vibration stresses. Made of aluminum with staked-in cable stop. Installed with same die as equivalent full tension sleeves. Prefilled with PENETROX™ joint compound, stripsealed and capped to limit oxide growth and increase the life of the connection.

Catalog Number	Conductor		L	Die Index	Tool Series, Die Set Catalog Number, & (Crimps per End)				
	ACSR, 6201, 5005	All Aluminum			MD7, MD6	35, 750	Y45	46	60
YCS4R	4	4 (7)	5	237	W237 (4)	U237 (2)	†	‡	—
YCS2R	2	2 (7)	5	239	W239 (4)	U239 (2)	†	‡	—
YCS25R	1/0	1/0 (7, 19)	7-1/8	243	WBG (5) W243 (7)	UBG (6)* U243 (4)	†	‡	—
YCS26R	2/0	2/0 (7, 19)	7	245	W245 (8)	U245 (4)	†	‡	—
YCS27R	3/0 110.8 (12-7)	3/0 (7, 19)	5-3/4	247	W247 (6)	U247 (3)	†	‡	—
YCS28R	4/0	4/0 (7, 19)	5-3/4	249	W249 (6)	U249 (3)	†	‡	L249 (2)
YCS30R	266.8 (6/7, 18-1, 26/7)	266.8	6-1/2	251	W251 (12)	U251 (6)	†	‡	L251 (3)
YCS321R	336.4 (18-1) 300	336.4 (19)	6-1/2	490	—	U490 (5)	†	‡	L490 (2)
YCS33R	336.4 (26-7, 30-7)	397.5 (19)	8-3/4	316	—	U316 (6)	†	‡	L316 (2)
YCS35R	397.5 (18-1, 26-7, 30-7)	477 (19, 37) 500 (37, 61)	8-7/8	317	—	U317 (6)	†	‡	L317 (2)
YCS361R	477 (18-1)	500 (37, 61)	8-1/4	327	—	U327 (6)	†	‡	L327 (2)
YCS37R	477 (24-7, 26-7, 30-7) 556.5 (18-1)	556.5 (19, 37)	8-3/4	261	—	U261 (6)	†	‡	L261 (2)
YCS39R	556.5 (24-7, 26-7)	—	10-3/4	608	—	U608 (9)	†	‡	L608 (3)
YCS43R	605 (30-19) 636 (24-7, 26-7, 30-19) 666.6 (24-7, 54-7)	795 (37)	10-5/8	292 or 319	—	—	S292 (6) S319 (6)	P292 (6) P319 (6)	L292 (3) L319 (3)
YCS453R	795 (36-1, 45-7)	—	10-5/8	292	—	—	S292 (6)	P292 (6)	L292 (3)
YCS45R	795 (26-7, 54-7)	900 (61, 91)	10-5/8	352	—	—	S352 (6)	P352 (6)	L352 (3)

† U Die with adapter PT6515
 ‡ U Die with adapter PUADP1.

For faster installations use
 BURNDY® PATRIOT® family of
 battery tools, dies and cutters.



UNISPLICE™ Single Sleeve Jumper, Type YCS-RL For AAC (Stranded, Compressed, Compact), ACSR, AAAC

Material: Aluminum

Tension Rating: ANSI C119.4 Class 2
(Partial Tension)

Aluminum jumper sleeve, with cable stop, designed to be installed with same dies as equivalent full-tension UNISPLICE™. Withstands jumper loop-tensile and vibration stresses. Prefilled with PENETROX™ joint compound, stripsealed and capped to limit oxide growth and increase the life of the connection.

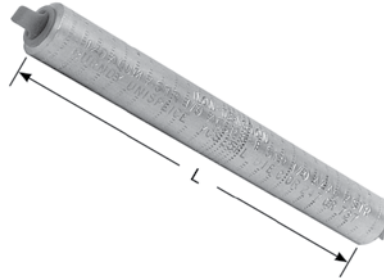

Catalog Number	Conductor †††	L	Die Index	Tool Series, Die Set Catalog Number, & (Crimps per End)	
				MD7, MD6	35,Y750, Y45†, 46‡
YCS25RL	1/0 ACSR (6-1) 1/0 6201 (7) 1/0 5005 (7) 1/0 AAC (7)	6-1/4	C or 247 or 702	WC (12) W702 (6)*	U247 (3)
YCS26RL	2/0 ACSR (6-1) 2/0 6201 (7) 2/0 5005 (7) 2/0 AAC (7)	5-5/8	659	—	U659 (3)
YCS28RL	4/0 ACSR (6-1) 4/0 6201 (7) 4/0 5005 (7) 4/0 AAC (7)	5-1/4	654	—	U654 (3)
YCS321RL	336.4 ACSR (18-1) 336.4 AAC (19)	5-1/4	655	—	U655 (3)
YCS341RL	397.5 AAC (19) 397.5 ACSR (18-1) 400 AAC (37, 61) 336.4 ACSR (18-1) 336.4 ACSR (26-7) 336.4 ACSR (30-7)	5-5/8	327	—	U327 (4)

* MD6 NON-BOW Dies produce straight sleeves without rotating tool.

† U Die with adapter PT6515

‡ U Die with adapter PUADP1.

††† Accommodates ACSR with aluminized steel core.

For faster installations use
BURNDY® PATRIOT® family of
battery tools, dies and cutters.



HYSPLICE™ Jumper Loop, Type YCS-A For AAC (Stranded, Compressed, Compact)

Material: Aluminum

Tension Rating: ANSI C119.4 Class 1A
 (Normal Tension)



HYSPLICE™ sleeve designed to withstand jumper loop tensile and vibration stresses up to 60% RBS. Made of aluminum with staked-in cable stop. Installed with same die as equivalent full-tension sleeve. Made from electrolytic grade aluminum. Surface oxides removed at factory and sealed. Pre-filled with PENETROX™ A joint compound, stripsealed and capped to limit oxide growth and to increase life of connection. For ACSR splices use the YCS-R or YCS-RL.

- † U Die with adapter PT-6515
- ‡ U Die with adapter PUADP-1.

For faster installations use BURNDY® PATRIOT® family of battery tools, dies and cutters.



Catalog Number	Conductor	L	Die Index	Tool Series, Die Set Catalog Number, & (Crimps per End)				
				MD7, MD6	35, 750	Y45	46	60
YCS26A	2/0 (7)	5-1/8	245	W245 (4)	U245 (2)	†	‡	—
YCS28A	4/0 (7, 19)	4	249	W249 (4)	U249 (2)	†	‡	L249 (1)
YCS301A	336.4 (19, 37)	4-3/8	321	—	U321 (3)	†	‡	L321 (2)
YCS311A	397.5 (19)	5-5/8	468	—	U468 (4)	†	‡	—
YCS331A	477 (19, 37, 61) 500 (19, 37, 61)	6-1/4	317	—	U317 (4)	†	‡	L317 (2)
YCS351A	556.5 (19, 37)	8-3/4	261	—	U261 (6)	†	‡	L261 (2)
YCS361A	636 (37)	7-3/8	469	—	—	S469 (4)	P469 (4)	L469 (2)
YCS391A	795 (37, 61)	10-1/2	342	—	—	S342 (4)	P342 (6)	L342 (3)

Jumper Sleeve Reducer, Type YCR For Copper

Material: Copper

Tension Rating: ANSI C119.4 Class 1A
 (Normal Tension)

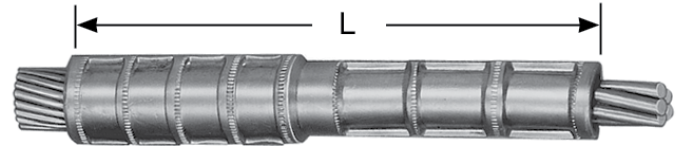

Copper sleeve designed to join different size copper conductors on transmission jumper applications. Installed with same dies as full-tension sleeves.

* Multiple crimp die set; makes more than one crimp per tool compression. Figure indicates number of compressions.

- † UDie with adapter PT6515.
- ‡ U Die with adapter PUADP1.

For faster installations use BURNDY® PATRIOT® family of battery tools, dies and cutters.



Catalog Number	Copper Conductor		L	Tool Series, Die Set Catalog Number, & (Crimps per End)							
				Side A				Side B			
	Side A	Side B		Die Index	MD7, MD6	35, 750, Y45†, 46‡	60	Die Index	MD6	35, 750, Y45†, 46‡	60
YCR2625	2/0 (7, 12, 19)	1/0 (7, 19)	3-3/8	166	W166 (6)	U166/U459	L166 (1)	165	W165 (3)	U165/U205	L165 (1)
YCR2725	3/0 (7, 19)	1/0 (7, 19)	3-1/2	167	—	U167/U568	L167 (1)	165	W165 (3)	U165/U205	L165 (1)
YCR2825	4/0 (7, 12, 19)	1/0 (7, 19)	3-3/8	168	—	U168 (3)	L168 (1)	165	W165 (3)	U165/U205	L165 (1)

Overhead Distribution

Compression Reducer - Single Sleeve Jumper Partial Tension
HYSPLICE™ Type YCR-R-G

HYSPLICE™ Single Sleeve Reducer Jumper, Type YCR-R-G

For AAC (Stranded, Compressed), ACSR, AAAC, Copper

Material: Aluminum

Tension Rating: ANSI C119.4 Class 2
(Partial Tension)

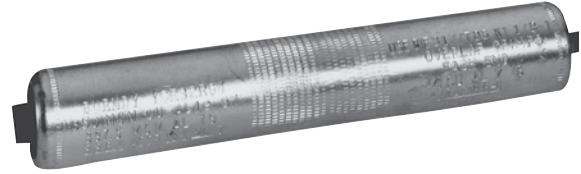

Heavy-walled aluminum sleeve designed to connect all aluminum or ACSR to copper conductors, in all service conditions encountered in transmission and distribution. Sleeve has solid center barrier and is prefilled with PENETROX™ joint compound, stripsealed and capped to limit oxide growth and increase life of connection.

* Crimps overlap on both ends.

† U Die with adapter PT6515

‡ U Die with adapter PUADP1

For faster installations use BURNDY® PATRIOT® family of battery tools, dies and cutters.



Catalog Number	Side A		Side B		L	O.D.	Tool Series, Die Set Catalog Number, & (Crimps per End)		
	ACSR, 6201, 5005	Aluminum, Copper	ACSR, 6201, 5005	Aluminum, Copper			Die Index	35, 750, Y45 †, 46 ‡	60
YCR25RG6	1/0 (6-1)	1/0 (7, 12, 19)	1/0 (6-1)	1/0 (7, 12, 19)	6-3/8	1-1/16	654 or 705	U654 U705 Crimps Overlap	L654 Crimps Overlap
YCR26RG2	2/0 (6-1)	2/0 (7, 12, 19)	1/0 (6-1)	1/0 (7, 12, 19)					
YCR26RG3			2/0 (6-1)	2/0 (7, 12, 19)					
YCR27RG5	3/0 (6-1)	3/0 (7, 12, 19)	1/0 (6-1)	1/0 (7, 12, 19)					
YCR27RG6			2/0 (6-1)	2/0 (7, 12, 19)					
YCR28RG5	4/0 (6-1)	4/0 (7, 12, 19)	1/0 (6-1)	1/0 (7, 12, 19)					
YCR28RG6			2/0 (6-1)	2/0 (7, 12, 19)					
YCR28RG7			3/0 (6-1)	3/0 (7, 12, 19)					
YCR28RG8			4/0 (6-1)	4/0 (7, 12, 19)					
YCR291RG2	266.8 (18-1)	250 (19, 37) 266.8 (7, 12, 19)	2/0 (6-1)	2/0 (7, 12, 19)	7-3/8	1-1/4	317 or 705	U317 U705 Crimps Overlap	L317 Crimps Overlap
YCR291RG3			3/0 (6-1)	3/0 (7, 12, 19)					
YCR291RG4			4/0 (6-1)	4/0 (7, 12, 19)					
YCR291RG5			266.8 (18-1)	250 (19, 37) 266.8 (7, 12, 19)					
YCR30RG4	266.8 (26-7)	300 (19, 37) 366.4 (19)	1/0 (6-1)	1/0 (7, 12, 19)					
YCR30RG6			3/0 (6-1)	3/0 (7, 12, 19)					
YCR30RG7			4/0 (6-1)	4/0 (7, 12, 19)					
YCR32RG1	336.4 (18-1) (26-7)	350 (19, 37) 397.5 (19)	1/0 (6-1)	1/0 (7, 12, 19)					
YCR32RG2			2/0 (6-1)	2/0 (7, 12, 19)					
YCR32RG3			3/0 (6-1)	3/0 (7, 12, 19)					
YCR32RG4			4/0 (6-1)	4/0 (7, 12, 19)					
YCR32RG5			266.8 (18-1)	250 (19, 37) 266.8 (7, 12, 19)					
YCR32RG6			266.8 (26-7)	300 (19, 37) 366.4 (19)					
YCR32RG7			336.4 (18-1) (26-7)	350 (19, 37) 397.5 (19)					

Compression Repair Sleeve, Types YCU-R, YOU-R For ACSR (Stranded, Compressed, Compact)

Material: Aluminum

For restoring conductivity to damaged conductors. Made of cast aluminum. Sizes up through 266.8 are U-shaped. For 300 and larger, sleeves are two-piece interlocking elements. Use same dies as equivalent full-tension sleeve. Use of PENETROX™ joint compound required.

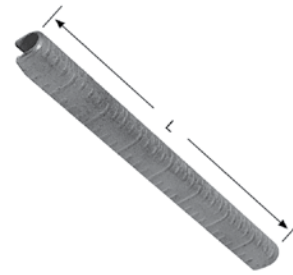

Catalog Number	Conductor	L	Die Index	Tool Series, Die Set Catalog Number & (Number of Crimps)				
				MD7, MD6	35, 750	Y45	Y46	60
YCU4R	4 (6-1), (7-1) 4AAC	6-1/4	237	W237 (12)	U237 (6)	†	‡	—
YCU4RG1	4 (7-1)	8-1/4	239	W239 (16)	U239 (8)	†	‡	—
YCU2R	2 (6-1, 7-1)	8-1/4	239	W239 (16)	U239 (8)	†	‡	—
YCU25R	1/0 (6-1)	8-3/4	243	W243 (20)	U243 (10)	†	‡	—
YCU26R	2/0 (6-1)	10	245	W245 (24)	U245 (12)	†	‡	—
YCU27R	3/0 (6-1)	10	247	W247 (24)	U247 (12)	†	‡	—
YCU28R	4/0 (6-1)	11-7/8	249	W249 (28)	U249 (14)	†	‡	L249 (7)
YCU30R	266.8 (6-1, 18-1, 26-7)	11-5/8	251	—	U251 (20)	†	‡	L251 (10)
YOU32R	300 (26-7)	13	316	—	U316 (21)	†	‡	L316 (7)
YCU321R	336.4 (18-1)	11-5/8	547, 655, 490	—	U490 (20)	†	‡	L490 (10)
YOU33R	336.4 (26-7, 30-7)	13	316	—	U316 (21)	†	‡	L316 (7)
YOU35R	397.5 (18-1, 26-7, 30-7)	13	317, 426	—	U317 (21)	†	‡	L317 (7)
YOU361R	477 (18-1)	12-47/50	327	—	U327 (21)	†	‡	L327 (7)
YOU37R	477 (24-7, 26-7, 30-7)	12-47/50	261, 318	—	U261 (21)	†	‡	L261 (7)
YOU39R	556.5 (24-7, 26-7)	13-3/4	608	—	U608 (24)	†	‡	L608 (8)
YOU41R	605 (24-7, 54-7)	13-3/4	292, 578, 319	—	—	S292 (24)	P292 (24)	L292 (8)
YOU43R	605 (30-19) 636 (26-7, 30-19) 666.6 (24-7, 54-7)	13-3/4	292, 319, 578	—	—	S292 (24) S319 (24)	P292 (24) P319 (24)	L292 (8) L319 (8)
YOU421R	636 (36-1)	13-3/4	292, 578	—	—	S292 (24)	P292 (24)	L292 (8)
YOU453R	715.5 (26-7) 795 (36-1)	13-3/4	292, 578	—	—	S292 (24)	P292 (24)	L292 (8) L578 (8)
YOU44R	715.5 (54-7)	13-3/4	319	—	—	S319 (24)	P319 (24)	L319 (8)
YOU45R	795 (26-7, 54-7)	13-3/4	352, 579	—	—	S352 (24) S579 (24)	P352 (24) P579 (24)	L352 (8) L579 (8)
YOU48R	900 (54-7) 954 (54-7)	14-1/4	575	—	—	—	—	L575 (10)
YOU49R	1033.5 (54-7)	14-1/4	422	—	—	—	—	L422 (10)

† U Die with adapter PT6515.
‡ U Die with adapter PUADP1.

For faster installations use BURNDY® PATRIOT® family of battery tools, dies and cutters.



HYSPLICE™ Repair Sleeve Type YCU-R For ACSR "Static Wire"

Material: Aluminum with Staked-In Cable Stop

HYSPLICE™ sleeve designed to withstand jumper loop tensile and vibration stresses. Made of aluminum with staked-in cable stop. Installed with same die as equivalent full tension sleeves. Prefilled with PENETROX™ joint compound.

RUS Accepted

† U Die with adapter PT-6515.
‡ U Die with adapter PUADP-1.
For faster installations use BURNDY® PATRIOT® family of battery tools.

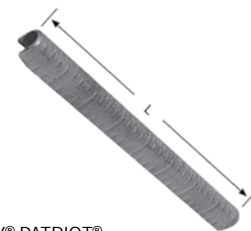

Catalog Number	Conductor	L	Die Index	Tool Series, Die Set Catalog Number & (Number of Crimps)		
				MD7, MD6	35, 750, Y45†, 46‡	60
YCU27R	110.8 (12-7)	10	247	W247 (24)	U247 (12)	—
YCU28R	159 (12-7)	11-7/8	249	W249 (28)	U249 (14)	L249 (7)
YCU30R	190.8 (12-7)	11-5/8	251	—	U251 (20)	L251 (10)

HYSPLICE™ Single Sleeve, Types YDS-W, YDS For Solid Copper

Material: Copper

Tension Rating: ANSI C119.4 Class 1
(Full Tension)

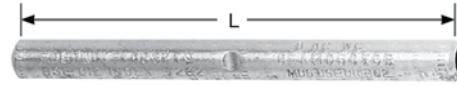

RUS Accepted

Type YDS-W sleeves are designed to develop full rated breaking strength of hard drawn and medium hard drawn solid copper conductor. Made of pure copper tubing, installed with standard tooling.

Catalog Number	Solid Conductor	L	Die Index	Tool Series, Die Set Catalog Number, & (Crimps per End)		
				MD7, MD6	35, 750, Y45†, 46‡	60
YDS8WG1	8 Sol.	1-7/8	161	W161 (1)	U161 (1)	—
YDS8W	8 Sol.	1-1/2	171	W171 (1)	U171 (1)*	—
YDS6W	6 Sol.	2-5/8	161	W161 (2)	U161 (1)*	—
YDS4W	4 Sol.	2-1/2	162	W162 (4)	U162 (1)*	—
YDS3W	3 Sol.	2-7/8	163, 308	W163 (4)	U163 (2)* U308 (2)*	—
YDS2W	2 Sol.	3-3/4	163	W163 (6)	U163 (2)*	—
YDS1W	1 Sol.	5-7/8	164	W164 (8)	U164 (4)*	—
YDS75	1/0 Sol.	6-1/4	165	W165 (6)	U165/U205 (6)	—
YDS76	2/0 Sol.	6-5/8	166	W166 (12)	U166/U459 (6)	—
YDS78	4/0 Sol.	7-7/8	168	—	U168 (9)	L168 (3)

* Multiple crimp die set; makes more than one crimp per tool compression.

Figure indicates number of compressions.

† U Die with adapter PT6515.

‡ U Die with adapter PUADP1.

For faster installations use
BURNDY® PATRIOT® family of
battery tools, dies and cutters.



HYSPLICE™ Single Sleeve, Types YDS, YDS-C For Stranded Copper

Material: Copper

Tension Rating: ANSI C119.4 Class 1
 (Full Tension)



Made of pure copper tubing. Designed to develop the full rated breaking strength of hard drawn or medium hard drawn copper conductor. Installed with standard tooling.

Catalog Number	Stranded Conductor	L	Die Index	Tool Series, Die Set Catalog Number, & (Crimps per End)		
				MD7, MD6	35, 750, Y45†, 46‡	60
YDS6C	6 (7)	2-3/4	161	W161 (2)	U161 (1)*	—
YDS4C	4 (7)	2-5/8	162	W162 (4)	U162 (1)*	—
YDS3C3	3 (3)	5-1/4	163	W163 (9)	U163 (3)*	—
YDS2C	2 (7)	3-5/8	163	W163 (6)	U163 (2)*	—
YDS2C3	2 (3)	3-5/8	163	W163 (6)	U163 (2)*	—
YDS1C	1 (7, 19)	4-1/4	164	W164 (6)	U164 (3)*	—
YDS1C3	1 (3)	6-1/4	459	W166 (3)	U459 (6)	—
YDS25	1/0 (7, 19)	5-3/8	165	W165 (6)	U165 / U205 (6)	—
YDS26	2/0 (7, 12, 19)	6	166	W166 (12)	U166 / U459 (6)	—
YDS27	3/0 (7, 19)	6-3/4	167	—	U167 / U568 (7)	—
YDS28	4/0 (7, 12, 19)	6-7/8	168	—	U168 (9)	L168 (3)
YDS29	250 (7, 12, 37)	7-1/2	169	—	C169 (9)	L169 (3)
YDS30	300 (19, 37)	8-1/8	170	—	U170 (13)	L170 (3)
YDS31	350 (12, 19, 37)	10-1/4	267	—	U267 (12)	L267 (4)
YDS32	400 (19, 37)	12-3/4	209	—	U209 (15)	L209 (5)
YDS34	500 (19, 37)	11-5/8	210	—	U210 (15)	L210 (5)
YDS39	750 (37)	12-3/4	627	—	—	L627 (7)
YDS44	1000 (61, 37)	15-1/4	345	—	—	L345 (10)

* Multiple crimp die set; makes more than one crimp per tool compression.
 Figure indicates number of compressions.
 † U Die with adapter PT6515.
 ‡ U Die with adapter PUADP1.

For faster installations use
 BURNDY® PATRIOT® family of
 battery tools, dies and cutters.



HYSPLICE™ Single Sleeve, Types YDS-A, YDS-AT For AAC (Stranded, Compressed, Compact)

Material: Aluminum

Tension Rating: ANSI C119.4 Class 1
(Full Tension)



Full Tension HYSPLICE™ sleeve made of aluminum tubing with staked-in cable stop. Sizes 1/0 and large tapered for gradual transition of stress. Installed with standard tools and dies. Prefilled with PENETROX™ joint compound, stripsealed, and capped to limit oxide growth and increase connection life.

Catalog Number	Conductor	L	Die Index	Tool Series, Die Set Catalog Number & (Number of Crimps)				
				MD7, MD6	35, 750	Y45	46	60
YDS6WA	6 (1)	3	161	W161 (2)	U161 (1)*	†	‡	—
YDS4WA	4 (1)	2-5/8	162	W162 (4)	U162 (1)*	†	‡	—
YDS2WA	2 (1)	3-7/8	163	W163 (6)	U163 (2)	†	‡	—
YDS6CA	6 (7)	3	161	W161 (2)	U161 (1)*	†	‡	—
YDS4CA	4 (7)	2-5/8	162	W162 (4)	U162 (1)*	†	‡	—
YDS2CA	2 (7)	3-7/8	163	W163 (6)	U163 (2)	†	‡	—
YDS25AT	1/0 (7)	7-1/4	BG 243	WBG (12) W243 (6)	UBG (6) U243 (3)	†	‡	—
YDS26AT	2/0 (7)	9-1/4	245	W245 (9)	U245 (5)	†	‡	—
YDS27AT	3/0 (7,19)	7-1/4	247	W247 (8)	U247 (4)	†	‡	L247 (3)
YDS28AT	4/0 (7, 19)	10-1/2	249	W249 (12)	U249 (6)	†	‡	L249 (3)
YDS29AT	250 (19)	7-1/2	616	—	U616 (6)	†	‡	—
YDS291AT	266.8 (7,19)	8-5/8	251	—	U251 (7)	†	‡	L251 (4)
YDS301AT	336.4 (19, 37)	9-7/8	321	—	U321 (8)	†	‡	L321 (4)
YDS31AT	350 (19)	11	490	—	U490 (9)	†	‡	L490 (3)
YDS311AT	397.5 (19)	12-1/4	468	—	U468 (10)	†	‡	—
YDS331AT	477 (19)	12-3/4	317	—	U317 (9)	†	‡	L317 (3)
YDS351AT	556.5 (19, 37)	12-3/4	261	—	U261 (9)	†	‡	L261 (3)
YDS361AT	636 (37)	13-1/2	469	—	—	S469 (8)	P469 (8)	L469 (4)
YDS391AT	795 (37), 800 (61)	13-5/8	342	—	—	S342 (8)	P342 (8)	L342 (4)
YDS431AT	954 (37, 61)	17-5/8	352	—	—	S352 (10)	P352 (10)	L352 (5)

* Multiple crimp die set; makes more than one crimp per tool compression.

Figure indicates number of compressions.

† U Die with adapter PT6515.

‡ U Die with adapter PUADP1.

For faster installations use
BURNDY® PATRIOT® family of
battery tools, dies and cutters.



UNISPLICE™ Single Sleeve, Types YDS-RL, YDS-LT
For AAC (Stranded, Compressed), ACSR, AAAC

Material: Aluminum

Tension Rating: ANSI C119.4 Class 1
(Full Tension)

Single-sleeve aluminum UNISPLICE™ connector is designed to splice ACSR as simply as aluminum. Prefilled with PENETROX™ joint compound, stripsealed, and capped to limit oxide growth and increase the life of the connection. Eliminates strand stripping, installing separate steel sleeve and filling with joint compound. Ends ACSR joint failure due to faulty positioning of sleeve and lack of joint compound. Simplifies hot-line splicing. Electrical and mechanical performance equal to two-piece sleeves.

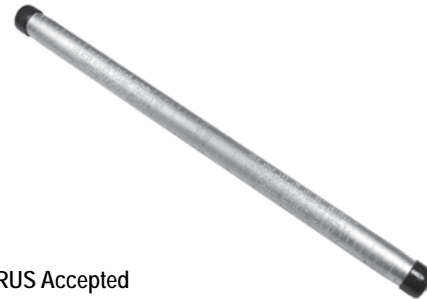

RUS Accepted

Catalog Number	Conductor †††	L	Die Index	Tool Series, Die Set Catalog Number, & (Crimps per End)			
				MD7, MD6	35, 750, Y45†, 46‡	60	644 and 444S Series
YDS4RL	4 ACSR (7-1) 4 ACSR (6-1) 4 6201 (7) 4 5005 (7) 4 AAC (7)	11-7/8	BG, or 243, or 687	BG (24) WBG (11)* W243 (9) W687 (11)**	UBG (9)* U243 (6)	L243 (3)	4
YDS2RL	2 ACSR (6-1) (7-1) 2 6201 (7) 2 5005 (7) 2 AAC (7)	10-1/4	BG, or 243, or 687	BG (20) WBG (10)* W243 (10) W687 (10)**	UBG (8)* U243 (5)	L243 (3)	4
YDS021RL	2 ACSR (7-1) 2 ACSR (6-1) 2 6201 (7) 2 AAC (7)	11-1/4	C, or 167, or 247, or 702	WC (30) W247 (14) W702 (11)**	U167/U568 (16) U247 (7)	L167 (7)	4
YDS25RL	1/0 ACSR (6-1) 1/0 6201 (7) 1/0 5005 (7) 1/0 AAC (7)	13-7/8	C, or 167, or 247, or 660, or 702	WC (30) W660 (14) W702 (12)**	U167/U568 (14) U660 (7) U247 (7)	L167 (5)	5
YDS26RL	2/0 ACSR (6-1) 2/0 6201 (7) 2/0 5005 (7) 2/0 AAC (7)	13-1/2	659	—	U659 (11) Crimps Overlap	—	5
YDS27RL	3/0 ACSR (6-1) 3/0 6201 (7) 3/0 5005 (7) 3/0 AAC (7)	18-1/4	658	—	U658 (16) Crimps Overlap	—	7
YDS28RL	4/0 ACSR (6-1) 4/0 6201 (7) 4/0 5005 (7) 4/0 AAC (7)	18-1/4	654	—	U654 (18) Crimps Overlap	—	7
YDS321RL	336.4 ACSR (18-1) 336.4 AAC (19) 350 AAC	18-1/4	655	—	U655 (21) Crimps Overlap	—	7

* Multiple crimp die set; makes more than one crimp per tool compression. Figure indicates number of compressions.

** MD6 NON-BOW Dies produce straight sleeves without rotating tool.

‡ U Die with adapter PUADP1.

† U Die with adapter PT6515.

†† Accommodates compact conductor.

††† Accommodates ACSR with aluminized steel core.

For faster installations use
BURNDY® PATRIOT® family of
battery tools, dies and cutters.



UNISPLICE™ Single Sleeve, Types YDS-RL, YDS-LT

For AAC (Stranded, Compressed), ACSR, AAAC

(Continued)

Catalog Number	Conductor	Code	L	Die Index	Tools, Die Set Catalog Number, & (Crimps per End)		
					35, 750, Y45†, 46‡	60	644 and 444S Series
YDS30LT	312.8 6201	BUTTE	—	317	U317	L317	—
YDS32LT	394.5 6201 394.5 5005 (336.4 E.C. Equiv.)	CANTON RADIANT	14-1/2	642	U642 (12)	L642 (4)	—
YDS341RL	397.5 ACSR (18-1) 419.6 5005	REDE	22	327	U327 (18)	—	9
YDS361RL	477 (18-1) 556.5 (18-1) 587.2 5005	RUBLE	23-1/4	720 788	U-788 (31) Crimps Overlap	L720 Crimps Overlap	9
YDS36LT	559.5 6201 559.5 5005 (477 E.C. Equiv.)	DARIEN REMEX	16	667	P667**	L667 Crimps Overlap	—

** 46 Series tools only.

For faster installations use
BURNDY® PATRIOT® family of
battery tools, dies and cutters.



UNISPLICE™ Single Sleeve, Type YDS-RLNI

For AAC (Stranded, Compressed) , ACSR, AAAC

Material: Aluminum

Tension Rating: ANSI C119.4 Class 1
(Full Tension)



RUS Accepted

Single-sleeve aluminum UNISPLICE™ connectors are designed to splice ACSR as simply as all aluminum. Prefilled with PENETROX™ joint compound, stripsealed, and capped to limited oxide growth and increase life of the connection. Eliminates strand stripping, installing separate steel sleeve and filling with joint compound. Ends ACSR joint failure due to faulty positioning of sleeve and lack of joint compound.

Simplifies hot-line splicing. Electrical and mechanical performance equal to two-piece sleeves. The UNISPLICE™ Type YDS-RLNI connectors are to be installed with the 644 or 444S family of next and indentor tools only.

Catalog Number	Conductor †††	L	Installation Tools / # of Crimps
			644 / 444S Series
YDS4RLNI	4 ACSR (7-1) 4 ACSR (6-1) 4 6201 (7) 4 5005 (7) 4 AAC (7)	10.2	4
YDS2RLNI	2 ACSR (6-1) (7-1) 2 6201 (7) 2 5005 (7) 2 AAC (7)	10.2	4
YDS021RLNI	2 ACSR (7-1) 2 ACSR (6-1) 2 6201 (7) 2 AAC (7)	10.2	4
YDS25RLNI	1/0 ACSR (6-1) 1/0 6201 (7) 1/0 5005 (7) 1/0 AAC (7)	12.4	5
YDS26RLNI	2/0 ACSR (6-1) 2/0 6201 (7) 2/0 5005 (7) 2/0 AAC (7)	12.4	5
YDS27RLNI	3/0 ACSR (6-1) 3/0 6201 (7) 3/0 5005 (7) 3/0 AAC (7)	17.4	7
YDS28RLNI	4/0 ACSR (6-1) 4/0 6201 (7) 4/0 5005 (7) 4/0 AAC (7)	17.4	7
YDS321RLNI	336.4 ACSR (18-1) 336.4 AAC (19) 350 AAC	17.5	7
YDS341RLNI	397.5 ACSR (18-1) 419.6 5005	22.0	9
YDS361RLNI	477 (18-1) 556.5 (18-1) 587.2 5005	23.3	9

†† Accommodates compact conductor.

††† Accommodates ACSR with aluminized steel core.

For faster installations use
BURNDY® PATRIOT® family of
battery tools, dies and cutters.



HYSPLICE™ Single Sleeve, Types YDS-A, YDS-AT

For AAC (Stranded, Compressed, Compact);

Installed with BURNDY or EEI Dies

Material: Aluminum

Tension Rating: ANSI C119.4 Class 1
(Full Tension)



Full-tension HYSPLICE™ sleeve made of aluminum tubing with staked-in cable stop. Sizes 1/0 and larger are tapered for gradual transition of stress. Installed with standard BURNDY® tooling. Prefilled with PENETROX™ joint compound, stripsealed and capped, to limit oxide growth and increase the life of the connection.

Catalog Number	Conductor	L	EEI Die Index	Index	Tools, Die Set Catalog Number (Crimps per End)	
					MD7, MD6	35, 750, Y45†, 46‡
YDS2CA	2 (7)	3-7/8	6A	693	W693 (8)	U693 (2)
YDS25AT	1/0 (7)	7-1/4	8A	243	W243(6)	U243(3)
YDS27AT	3/0 (7,19)	7-1/4	10A	694	W694 (8)	U694 (4)
YDS28AT	4/0 (7, 19)	10-1/2	11A	249	W249 (12)	U249 (6)
YDS311AT	397.5 (19)	12-1/4	13A	655	—	U655 (10)
YDS331AT	477 (19)	12-3/4	14A	317	—	U317 (9)

† U Die with adapter PT6515.

‡ U Die with adapter PUADP1.

For faster installations use BURNDY® PATRIOT® family of battery tools, dies and cutters.



UNISPLICE™ Single Sleeve, Type YDS-RLY For AAC (Stranded, Compressed), ACSR, AAAC

Material: Aluminum

Tension Rating: ANSI C119.4 Class 1
(Full Tension)

Similar to the single-sleeve aluminum UNISPLICE™ connectors Type YDS-RL in most ways, the Type YDS-RLY are specifically designed to eliminate possible conductor basketing (bird caging) on ACSR. Installed by crimping form end of connector towards center with standard installation tooling. Supplied prefilled with PENETROX™ joint compound, stripsealed, and capped to limit oxide growth and increase the life of the connection. Factory installed tape on pressure relief holes must be in place when conductors are inserted.

For faster installations use
BURNDY® PATRIOT® family of
battery tools, dies and cutters.

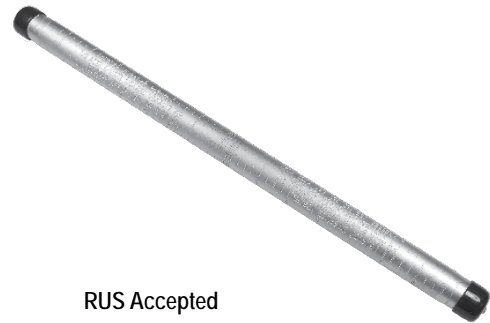

RUS Accepted

* Multiple crimp die set; makes more than one crimp per tool compression. Figure indicates number of compressions.

** MD6 NON-BOW Dies produce straight sleeves without rotating tool.

‡ U Die with adapter PUADP1.

† U Die with adapter PT6515.

††† Accommodates ACSR with aluminized steel core.

Catalog Number	Conductor †††	L	Die Index	Tool Series, Die Set Catalog Number, & (Crimps per End)			
				MD7, MD6	35, 750, Y45†, 46‡	60	644 and 444S Series
YDS4RLY	4ACSR (7-1) 4ACSR (6-1) 4 6201 (7) 4 5005 (7) 4AAC (7)	12-1/2	BG, or 243, or 687	BG (20) WBG (10)* W687 (10)**	UBG (8)* U243 (6)	L243 (3)	4
YDS2RLY	2ACSR (6-1) 2 6201 (7) 2 5005 (7) 2AAC (7)	12-3/8	BG, or 243, or 687	BG (20) WBG (10)* W687 (10)**	UBG (8)* U243 (6)	L243 (3)	4
YDS021RLY	2ACSR (7-1) 2ACSR (6-1) 2 6201 (7) 2AAC (7)	14-3/8	C, or 167, or 247, or 702	WC (24) W702 (11)**	U167 (12) U247 (6)	L167 (6)	4
YDS25RLY	1/0 ACSR (6-1) 1/0 6201 (7) 1/0 5005 (7) 1/0 AAC (7)	17	C, or 167, or 247, or 660, or 702	WC (30) W660 (14) W702 (12)**	U167/U568 (14) U660 (7) U247 (7)	L167 (5)	5
YDS26RLY	2/0 ACSR (6-1) 2/0 6201 (7) 2/0 5005 (7) 2/0 AAC (7)	15	659	—	U659 Crimps Overlap	—	5
YDS27RLY	3/0 ACSR (6-1) 3/0 6201 (7) 3/0 5005 (7) 3/0 AAC (7)	21	658	—	U658 Crimps Overlap	—	7
YDS28RLY	4/0 ACSR (6-1) 4/0 6201 (7) 4/0 5005 (7) 4/0 AAC (7)	21	654	—	U654 Crimps Overlap	—	7
YDS321RLY	336.4 ACSR (18-1) 336.4 AAC (19)	20-1/2	655	—	U655 Crimps Overlap	—	7

Overhead Distribution

Compression Splices - Two Sleeve Full Tension
HYSPLICE™ Types YDS-R SET, YDS-RP1, YDS-RP2

HYSPLICE™ Two Sleeve, Types YDS-R SET, YDS-RP1 (Aluminum), YDS-RP2 (Steel)

For ACSR (Stranded, Compressed, Compact)

Material: Aluminum (Outer Sleeve)
Steel (Inner Sleeve)

Tension Rating: ANSI C119.4 Class 1
(Full Tension)



RUS Accepted

Two-piece, full tension HYSPLICE™ connectors, consist of an aluminum outer sleeve and steel inner sleeve. Tapered outer sleeve provides gradual transition of stress. Filler holes provided for PENETROX™ joint compound. Sizes 1/0 and larger are supplied with plugs for filler hole. Installed with standard tooling and dies (Series 35 and Series 750 platforms install through 556). Aluminum and steel sleeves can be ordered separately or in sets.

* Multiple crimp die set; makes more than one crimp per tool compression.

Figure indicates number of compressions.

† U Die with adapter PT6515.

‡ U Die with adapter PUADP1.

For faster installations use
BURNDY® PATRIOT® family of
battery tools, dies and cutters.



Catalog Number			Conductor	L	Die Index	Tools, Die Set Catalog Number, & (Crimps per End)		
Set	Sleeves					MD7, MD6	35, 750, Y45†, 46‡	60
YDS021R	Steel Alum.	YDS25RP2 YDS021RP1	2 (7/1) Sparate	4.75" 17.00"	242 241	W242 (8) W241 (10)	U242 (4) U241 (5)	—
YDS1R	Steel Alum.	YDS1RP2 YDS1RP1	1 (6/1) Robin	4.13" 16.63"	240 241	W240 (6) W241 (10)	U240 (3) U241 (5)	—
YDS25R	Steel Alum.	YDS25RP2 YDS25RP1	1/0 (6/1) Raven	4.75" 17.00"	242 243	W242 (8) W243 (12)	U242 (4) U243 (6)	—
YDS26R	Steel Alum.	YDS26RP2 YDS26RP1	2/0 (6/1) Quail	5.25" 19.75"	242 245	W242 (8) W245 (15)	U242 (4) U245 (8)	—
YDS27R	Steel Alum.	YDS27RP2 YDS27RP1	3/0 (6/1) Pigeon	5.25" 16.75"	248 247	W248 (16) W247 (12)	U248 (8) U247 (6)	L248 (3)* L247 (4)*
YDS28R	Steel Alum.	YDS28RP2 YDS28RP1	4/0 (6/1) Penguin	5.13" 18.88"	248 249	W248 (14) W249 (14)	U248 (7) U249 (7)	L248 (4)* L249 (4)
YDS291R	Steel Alum.	YDS1RP2 YDS291RP1	266.8 (18 - 1)	4-1/8" 19-3/4"	240 251	W240 (6) —	U240 (3) U251 (12)	— L251 (6)
YDS30R	Steel Alum.	YDS30RP2 YDS30RP1	266.8 (26/7) Owl 266.8 (26/7) Partridge	6.00" 19.75"	250 251	—	U250 (10) U251 (10)	L250 (3) L251 (5)
YDS321R	Steel Alum.	YDS25RP2 YDS321RP1	336.4 (18/1) Merlin	4.75" 17.88"	242 490	W242 (8) —	U242 (4) U490 (10)	L242 (2)* L490 (4)
YDS32R	Steel Alum.	YDS32RP2 YDS33RP1	336.4 (26/7) Linnet 336.4 (30/7) Oriole	6.88" 22.25"	252 316	—	U252 (9) U316 (9)	L252 (3) L316 (3)
YDS33R	Steel Alum.	YDS41RP2 YDS33RP1	336.4 (30/7) Oriole	8.63" 22.25"	305 316	—	U305 (9) U316 (9)	L305 (3) L316 (3)
YDS34R	Steel Alum.	YDS34RP2 YDS35RP1	397.5 (26/7) Ibis 397.5 (30/7) Lark	6.25" 25.63"	253 317	—	U253 (9) U317 (12)	L253 (3) L317 (4)
YDS35R	Steel Alum.	YDS44RP2 YDS35RP1	397.5 (30/7) Lark	8.00" 25.63"	255 317	—	U255 (12) U317 (12)	L255 (4) L317 (4)
YDS361R	Steel Alum.	YDS27RP2 YDS361RP1	477.0 (18/1) Pelican	5.25" 25.63"	248 327	W248 (16) —	U248 (8) U327 (16)	L248 (4)* L327 (5)
YDS326R	Steel Alum.	YDS34RP2 YDS37RP1	477.0 (24/7) Flicker 477.0 (26/7) Hawk 477.0 (30/7) Hen	6.25" 26.38"	253 261	—	U253 (9) U261 (12)	L253 (3) L261 (4)
YDS36R	Steel Alum.	YDS36RP2 YDS37RP1	477.0 (26/7) Hawk	7.88" 26.38"	350 261	—	U350 (12) U261 (12)	L350 (4) L261 (4)

HYSPLICE™ Two Sleeve, Types YDS-R SET, YDS-RP1 (Aluminum), YDS-RP2 (Steel)

For ACSR (Stranded, Compressed, Compact)
 (Continued)

RUS Accepted



Catalog Number		Conductor	L	Die Index	Tool Series, Die Set Catalog Number, & (Crimps per End)				
Set	Sleeves				35, 750,	Y45	46	60	
YDS392R	Steel	YDS41RP2 YDS39RP1	556.5 (24-7)	8-5/8 26-1/8	305 608	U305 (9)	†	‡	L305 (3)
	Alum.					U608 (15)	†	‡	L608 (5)
YDS40R	Steel	YDS44RP2 YDS39RP1	556.5 (26-7)	8 26-1/8	255 608	U255 (12)	†	‡	L255 (4)
	Alum.					U608 (15)	†	‡	L608 (5)
YDS42R	Steel	YDS43RP2 YDS43RP1	636 (24-7)	8 32-1/2	254 319	—	S254 (15)	P254 (15)	L254 (5)
	Alum.					—	S319 (18)	P319 (18)	L319 (6)
YDS43R45RS	Steel	YDS45RP2 YDS43RP1	636 (26-7)	9 32-1/2	320 319	—	S320 (15)	P320 (15)	L320 (5)
	Alum.					—	S319 (18)	P319 (18)	L319 (6)
YDS43R43RS	Steel	YDS43RP2 YDS43RP1	666.6 (24-7)	8 32-1/2	254 319	—	S254 (15)	P254 (15)	L254 (5)
	Alum.					—	S319 (18)	P319 (18)	L319 (6)
YDS451R49RS	Steel	YDS49RP2 YDS451RP1	795 (26-7)	10 32-1/2	419 579	—	—	P419 (21)	L419 (7)
	Alum.					—	S579 (13)	P579 (13)	L579 (6)
YDS45R45RS	Steel	YDS45RP2 YDS45RP1	795 (54-7)	9 32-1/2	320 352	—	S320 (15)	P320 (15)	L320 (5)
	Alum.					—	S352 (12)	P352 (12)	L352 (6)
YDS451R34RS	Steel	YDS34RP2 YDS451RP1	900 (45-7)	6-1/4 32-1/2	253 579	U253 (9)	†	‡	L253 (3)
	Alum.					—	S579	P579	L579 (6)
YDS49R	Steel	YDS49RP2 YDS49RP1	1033.5 (54-7)	10 37	419 422	—	—	—	L419 (7)
	Alum.					—	—	—	L422 (8)
YDS50R	Steel	YDS36RP2 YDS49RP1	1113 (45-7)	7-7/8 37	350 422	U350 (12)	†	‡	L350 (4)
	Alum.					—	—	—	L422 (8)

† U Die with adapter PT6515.
 ‡ U Die with adapter PUADP1.

For faster installations use
 BURNDY® PATRIOT® family of
 battery tools, dies and cutters.



For ACSR "Static" Wire

Catalog Number		Conductor	L	Die Index	Tool Series, Die Set Catalog Number, & (Crimps per End)			
Set	Sleeves				MD7, MD6	35, 750, Y45†, 46‡	60	
YDS011R	Steel	YDS27RP2 YDS011RP1	80 (8/1)	5-1/4 19-3/4	248 245	W248 (16)	U248 (8)	—
	Alum.					W245 (12)	U245 (6)	—
YDS251R	Steel	YDS34RP2 YDS251RP1	101.8 (12/7)	6-1/4 22-1/4	253 316	—	U253 (9)	L253 (3)
	Alum.					—	U316 (9)	L316 (3)
YDS261R	Steel	YDS41RP2 YDS261RP1	134.6 (12/7)	8-5/8 22-1/4	305 316	—	U305 (9)	L305 (3)
	Alum.					—	U316 (9)	L316 (3)
YDS271R	Steel	YDS44RP2 YDS271RP1	159 (12/7)	8 25-5/8	255 317	—	U255 (12)	L255 (4)
	Alum.					—	U317 (12)	L317 (4)

† U Die with adapter PT6515.
 ‡ U Die with adapter PUADP1.

HYSPLICE™ Two Sleeve, Types YDS-R, YDS-RE For ACSR

Material: Aluminum (Outer Splice)
Steel (Inner Splice)

Tension Rating: ANSI C119.4 Class 1
(Full Tension)



Two-piece, full tension HYSPLICE™ splices, made of aluminum outer sleeve and steel sleeve for steel core. Designed to be installed with BURNDY® EEI dies. BURNDY® and EEI die index numbers are clearly marked on the sleeve.

Catalog Number Aluminum & Steel Sleeve Set	Catalog Number Aluminum Sleeve	Conductor	Aluminum Outer Sleeve					Catalog Number Steel Sleeve	Steel Inner Sleeve				
			L	EEI Die #	Die Index	Tools, Die Set Catalog No., & (Crimps per End)			LL	EEI Die #	Die Index	Tools, Die Set Catalog No., & (Crimps per End)	
						MD6	35, 750, Y45†, 46‡					MD6	35, Y750, Y45†, 46‡
YDS2RE	YDS021REP1	2 (6-1)	17-1/8	6A	693	W693 (20)	U693 (5)	YDS2REP2	4-1/8	1S	690	W690 (8)	U690 (4)
YDS021RE	—	2 (7-1)		8A	243	W243 (10)	U243 (5)	YDS25REP2	4-3/4	2S	691	W691 (9)	U691 (3)
—	YDS25RP1	1/0 (6-1)	19-3/4	9A	245	W245 (12)	U245 (6)	—	5-1/4	4S	692	W692 (12)	U692 (6)
—	YDS26RP1	2/0 (6-1)		10A	694	W694 (12)	U694 (6)	YDS27RP2	5-1/4	5S	248	W248 (8)	U248 (8)
YDS27RE	YDS27RP1	3/0 (6-1)	18-7/8	11A	249	W249 (14)	U249 (7)	YD28REP2	5-1/4	5S	248	W248 (8)	U248 (8)
YDS28RE	YDS28RP1	4/0 (6-1)	17-7/8	13A	655	—	U655 (9)	YDS25REP2	4-3/4	2S	691	W691 (9)	U691 (3)
—	—	336.4 (18-1)		14A	327	W327	U327 (16)	YDS27RP2	5-1/4	5S	248	W248 (8)	U248 (3)
YDS361R	YDS361RP1	477 (18-1)											

† U Die with adapter PT6515.
‡ U Die with adapter PUADP1.

For faster installations use BURNDY® PATRIOT® family of battery tools, dies and cutters.



HYSPLICE™ Two Sleeve, Types YDS-E, YDS-H, YDS-U For Steel

Material: Steel

Tension Rating: ANSI C119.4 Class 1
(Full Tension)



* Multiple crimp die set; makes more than one crimp per tool compression. Figure indicates number of compressions.
† U Die with adapter PT6515.
‡ U Die with adapter PUADP1.

Full tension HYSPLICE™ sleeves designed for HS, EHS, Utilities (UT), or Siemens-Martin (SM) galvanized steel guy, messenger, and "Static" conductor. Made of hot-rip galvanized seamless milled steel tubing lined with silicone carbide particles.

For faster installations use BURNDY® PATRIOT® family of battery tools, dies and cutters.



Catalog Number	Conductor			L	Die Index	Tools, Die Set Catalog Number, & (Crimps per End)	
	Size	Str.	Grade			35, 750, Y45†, 46‡	60
YDS250E	1/4	7	EHS	6-3/4	609	U609 (10)	—
YDS312H	5/16	7	HS	10-5/8	257	U257 (20)	L257 (5)*
YDS312E	5/16	7	EHS	8-1/2	305	U305 (6)	L305 (3)
YDS375H	3/8	7	HS, UT	9	304	U304 (12)	L304 (4)
YDS500H	1/2	7	HS	9-5/8	293	—	L293 (6)

**UNISPLICE™ Single Sleeve Replacement Splice,
Type YDSR-RL**

For AAC (Stranded, Compact), ACSR, AAAC

Material: Aluminum

Tension Rating: ANSI C119.4 Class 1A
(Full Tension)

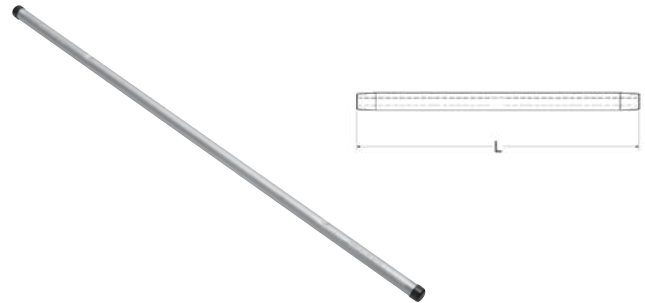

Single sleeve aluminum UNISPLICE™ replacement splices are designed to facilitate the permanent replacement of existing line splices, including automatic type. Utilizing all the benefits of the standard UNISPLICE™ connectors, the extra long Replacement UNISPLICE™ Type YDSR-RL fills the gap of a cutout splice and eliminates the need to find like conductor. It also reduces installation time of the current standard methods by half, reducing the total number of splices necessary from two to one. All splices are prefilled with PENETROX™ joint compound, stripsealed, and capped to limit oxide growth and to increase the life of the connection.

- ① U Die with adapter PT-6515.
- ② U Die with adapter PUADP-1.
- * Multiple crimp die set; makes more than one crimp per tool compression. Figure indicates number of compressions.
- ** MD6 NON-BOW Dies produce straight sleeves without rotating tool.
- † Overlap Crimps
- For faster installations use BURNDY® PATRIOT® family of battery tools.

Catalog Number	Conductor		L	Die Index	Installation Tooling Data (# of crimps per end)					
	AWG / kcmil	Str.			MD7, MD6 HYTOOL™	35	750	Y45 ①	46 ②	644 and 444S Series
YDSR4RL	4 ACSR 4 6201 4 5005 4 AAC	6-1; 7-1 7 7 7	24.63"	BG 687 243	WBG (11)* W687 (9)** W243 (11)	UBG (9)* U243 (6)	UBG (9) U243 (6)	UBG (9) U243 (6)	UBG (9) U243 (6)	4
YDSR2RL	2 ACSR 2 6201 2 5005 2 AAC	6-1; 7-1 7 7 7	28.00"	BG 687 243	WBG (20) W687 (10)** W243 (10)	UBG (8)* U243 (5)	UBG (8) U243 (5)	UBG (8) U243 (5)	UBG (8) U243 (5)	4
YDSR25RL	1/0 ACSR 1/0 6201 1/0 5005 1/0 AAC	6-1 7 7 7	34.13"	C 167 247 660 702	WC (30) W247 (14) W660 (15) W702 (14)**	U167/U568 (15) U247 (8) U660 (8)	U167/U568 (15) U247 (8) U660 (8)	U167/U568 (15) U247 (8) U660 (8)	U167/U568 (15) U247 (8) U660 (8)	4
YDSR26RL	2/0 ACSR 2/0 6201 2/0 5005 2/0 AAC	6-1 7 7 7	35.50"	659	—	U659 † (11)	U659 † (11)	U659 † (11)	U659 † (11)	5
YDSR27RL	3/0 ACSR 3/0 6201 3/0 5005 3/0 AAC	6-1 7 7 7	42.25"	658	—	U658 † (16)	U658 † (16)	U658 † (16)	U658 † (16)	5
YDSR28RL	4/0 ACSR 4/0 6201 4/0 5005 4/0 AAC	6-1 7 7 7	45.75"	654	—	U654 † (18)	U654 † (18)	U654 † (18)	U654 † (18)	7
YDSR321RL	336.4 ACSR 336.4 AAC 350.0 AAC	18-1 19 19	45.75"	655	—	U655 † (21)	U655 † (21)	U655 † (21)	U655 † (21)	7
YDSR341RL	397.5 ACSR 419.6 5005	18-1 19	49.50"	327	—	U327 (18)	U327 (18)	U327 (18)	U327 (18)	7
YDS361RL	477 (18-1) 556.5 (18-1) 587.2 5005	18-1 18-1 19	23.21"	720 788	—	U-788 † (31)	U-788 † (31)	U-788 † (31)	U-788 † (31)	9

UNISPLICE™ Reducer Splice; Type YDR-R For AAC (Stranded, Compressed), ACSR, AAAC

Material: Aluminum

Tension Rating: ANSI C119.4 Class 1
(Full Tension)

Single-sleeve aluminum UNISPLICE™ reducer is designed to splice ACSR as simply as all aluminum. Prefilled with PENETROX™ joint compound, stripsealed, and capped to limit oxide growth and increase the life of the connection. Eliminates strand stripping, installing separate steel sleeve and filling with joint compound. Electrical and mechanical performance equal to two-piece sleeves.

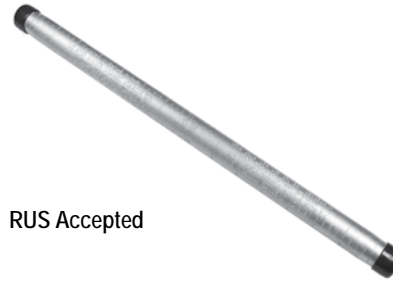

RUS Accepted

Catalog Number	Side A		Side B		L	OD	Tools, Die Set Catalog Number (# crimps per side)			
	ACSR, 6201, 5005	Aluminum	ACSR, 6201, 5005	Aluminum			Die Index	MD6 / MD7 Series	35 and 750 Series	644 and 444S Series
YDR2R4RG1	#2 (6/1)	#2	#4 (6/1)	#4	11.91	0.66	BG 243	WBG (10) W243 (12)	UBG (1) U243 (6)	4
YDR25R4RL	1/0 (6/1)	1/0	#4 (6/1)	#4	12.93	0.80	167 247 K737	W167 (32) W247 (16) WK737 (32)	U167 (14) U247 (7) UK737 (14)	5
YDR25R2RL	1/0 (6/1)	1/0	#2 (6/1)	#2	12.93	0.80	167 247 K737	W167 (32) W247 (16) WK737 (32)	U167 (14) U247 (7) UK737 (14)	5
YDR27R25RL	3/0 (6/1)	3/0	1/0 (6/1)	1/0	18.18	0.91	658	—	U658 (16 overlap) U658 (11 spaced)	7
YDR28R26R	4/0 (6/1)	4/0	2/0 (6/1)	2/0	18.65	1.02	654	—	U654 (18 overlap) U654 (12 spaced)	7
YDR28R27R	4/0 (6/1)	4/0	3/0 (6/1)	3/0	18.65	1.02	654	—	U654 (18 overlap) U654 (12 spaced)	7
YDR391RL321RL	556.5 (18/1)	—	336.4 (18/1)	—	16.27	1.40	318/261	—	U261 (12)	7

* Multiple crimp die set; makes more than one crimp per tool compression. Figure indicates number of compressions.

For faster installations use
BURNDY® PATRIOT® family of
battery tools, dies and cutters.



HYSPLICE™, Type YDS-K For Copperweld

Material: Copper

Tension Rating: ANSI C119.4 Class 1
 (Full Tension)

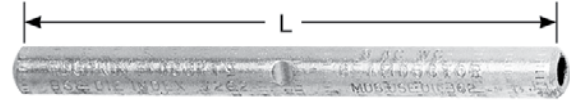

Full tension HYSPLICE™ designed to exceed the minimum rated breaking strength of 30% conductivity extra high strength Copperweld and lower strength conductors. Made of pure copper tubing. Installed with standard BURNDY® tools and dies.

* Multiple crimp die set; makes more than one crimp per tool compression. Figure indicates number of compressions.
 † U Die with adapter PT-6515.
 ‡ U Die with adapter PUADP-1

For faster installations use BURNDY® PATRIOT® family of battery tools, dies and cutters.



Catalog Number	Conductor	L	Die Index	Tool Series, Die Set Catalog Number, & (Crimps per End)		
				MD7, MD6	35, 750, Y45†, 46‡	60
YDS8WK	8 Sol.	3-3/4	285, or 162	W162 (6)	U285 (2)	—
YDS6WK	6 Sol.	4-3/8	276, or 162	W162 (6)	U276 (6)	—
YDS3K10	(3 #10)	4-7/8	403	—	U403 (3)*	—
YDS3K8	(3 #8)	5-5/8	205	—	U205 (5)	—
YDS3K7	5/16 (7 #10) (3 #7)	10	167	—	U167/U568 (10)	L167 (4)
YDS3K6	11/32 (7#9) (3#6)	9-1/2	331	—	U331 (9)	L331 (3)
YDS3K5	3/8 (7 #8) (3 #5)	6-7/8	259	—	U259 (6)	L259 (2)
YDS7K7	7/16 (7 #7)	6-7/8	328	—	—	L328 (3)
YDS7K6	1/2 (7 #6)	9-3/8	260	—	—	L260 (4)
YDS7K5	9/16 (7 #5)	11-3/8	344	—	—	L344 (6)

Single Sleeve Splice, Type YTS-E For EHS Steel

Material: Aluminum

Tension Rating: ANSI C119.4 Class 1
 (Full Tension)

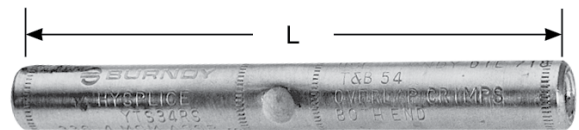

RUS Accepted

Full tension splice for EHS steel guy, messenger, or "static" cable. Sleeve is prefilled with PENETROX™ joint compound, stripsealed, and capped to limit oxide growth and increase the life of the connection.

Catalog Number	Conductor †	L	Tool Series, Die Sets	
	EHS Steel		Die Index	60*
YTS375E	3/8" 7 Str.	10-3/8	723	L723
YTS438E	7/16" 7 Str.	11-7/8	726	L726

* Overlap crimps.
 † Sleeve is high strength aluminum alloy for optimum corrosion resistance.
 For faster installations use BURNDY® PATRIOT® family of battery tools.

For faster installations use BURNDY® PATRIOT® family of battery tools, dies and cutters.



HYSPLICE™, Types YDS-KT, YDS-F For Copperweld, Copper

Material: Copper

Tension Rating: ANSI C119.4 Class 1
(Full Tension)

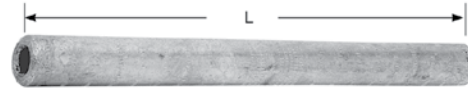

RUS Accepted

Full tension HYSPLICE™ splice is made of pure copper tubing. Type YDS-KT is tapered to provide gradual transition of stress on Type "A" conductor. HYSPLICE™ Type YDS-F connectors are recommended for Type "F" conductor.

Catalog Number	Conductor	L	Die Index	Tools, Die Set Catalog Number, & (Crimps per End)		
				MD7, MD6	35, 750, Y45†, 46‡	60
YDS8KT	8A	5	162 or 202	W162 (4)	U202 (4)*	—
YDS6KT	6A	6-1/8	162 or 203	W162 (5)	U203 (5)*	—
YDS4KT	4A	6-3/8	163 or 204	W163 (5)	U204 (10)	—
YDS2KT	2A	7-3/4	205	—	U205	—
YDS3K6	11/32 (7#9) (3#6)	9-1/2	331	—	U331 (9)	L331 (3)
YDS2F	2F	6-1/4	329	—	U329 (4)	—
YDS25F	1/0F	8-3/4	568	—	U167/U568 (8)	—
YDS26F	2/0F	9-5/8	552	—	U552 (11)	—
YDS28F	4/0F	11-7/8	331	—	U331 (12)	L331(4)

* Multiple crimp die set; makes more than one crimp per tool compression. Figure indicates number of compressions.

† U Die with adapter PT6515.

‡ U Die with adapter PUADP1.

For faster installations use BURNDY® PATRIOT® family of battery tools, dies and cutters.



Single Sleeve Splice, Type YDS-M-T For Alumoweld

Material: Aluminum

Tension Rating: ANSI C119.4 Class 1
(Full Tension)



RUS Accepted

Full tension splice for Alumoweld transmission lines. Five connectors accommodate eight conductor sizes. Sleeve is pre-filled with PENETROX™ joint compound and capped.

* Overlap crimps.

† U Die with adapter PT6515.

‡ U Die with adapter PUADP1.

††† Sleeve is high strength aluminum alloy for optimum corrosion resistance.

For faster installations use BURNDY® PATRIOT® family of battery tools, dies and cutters.



Catalog ††† Number	Conductor ALUMOWELD	L	Tools, Die Sets		
			Die Index	35, 750, Y45†, 46‡	60
YDS7M10T	7 #10, 3 #7	10	676 or 721	U676 (8)	L721
YDS7M9T	7 #9, 3 #6	10-3/8	677	U677 (10)	—
YDS7M8T	7 #8, 3 #5	12-1/4	668 or 723	U668 (13)	L723
YDS7M7T	7 #7	14-1/2	678 or 726	U678 (19)	L726
YDS7M6T	7 #6	15-1/8	679 or 726	U679 (2)	L726

Table of Contents

Deadend Fitting and Accessories.....	H-72
Loop	
Type UP-R.....	H-72
Type BC.....	H-73
Type M.....	H-73
Primary and Bus Strain	
Type CUW-E.....	H-74
Type DUW.....	H-74
Types CUW-A-E, CUW-R-E.....	H-75
Types DUW-A, DUW-A-E.....	H-75

Most frequently ordered catalog numbers are highlighted in BLUE

Deadend Fittings and Accessories

General Overview

The deadend method selected for any particular application will depend upon the nature of the application, the size of the conductor, holding strength required, and preference for mechanical or compression devices.

Secondaries are commonly deadended by bending wire around a spool insulator and snubbing with the same connectors used for the secondary to service drop connection. On copper conductor, connectors such as U-bolt deadend Type BC, SERVIT® Type KS, OKLIP™ connector Type KVS or CRIMPIT™ Type YC-C are recommended. These connectors provide high holding strength without damaging conductor strands. On aluminum wires, CLIPIT™ UW-R, mechanical connector is recommended.

The same methods can also be used on primaries. However, the straight line clamp Type CUW-A-E is more popular for this application. They are easier to install on either hot or de-energized lines. They are particularly well suited to hot-line maintenance, and allow easy re-sagging of conductors.

Straight line types are also popular for deadending strain buses. These are normally large, hard to handle conductors that do not lend themselves to snub or "quadrant" types. Types DUW or CUW-E are recommended for copper conductor and DUW-A and DUW-AE for aluminum and ACSR. The pulling eye on the DUW-A-E is in line with the cable to make installation easier.

Heavy Duty Parallel Clamp Type UP-R

For AAC (Stranded, Compressed, Compact†), ACSR†, AAAC, Copper

Material: Aluminum

Heavy duty aluminum connector for feeder, subtransmission, and primary distribution. Massive design and large spacer give maximum protection against galvanic action and overload conditions. Spacing of U-bolts, tapered bell mouths, and modified V groove minimize cold flow, eliminate cable damage, and produce wiping action on conductors. Spacer taps confine cable strands to prevent splaying. Captured, heat treated aluminum alloy U-bolts. PENETROX™ joint compound recommended for all combinations.

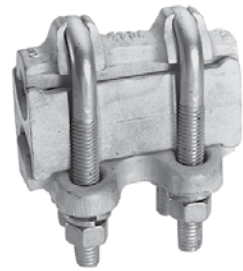

RUS Accepted

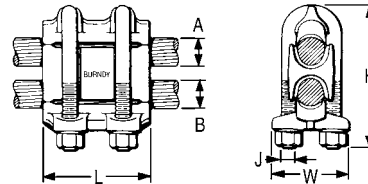

Catalog Number	Groove A		Groove B		Dimensions			
	ACSR †, 6201, 5005	Copper or Aluminum †	ACSR †, 6201, 5005	Copper or Aluminum †	H	J	L	W
UP34R	110.8 (12-7) - 397.5 (18-1)	3/0 Str. - 400	110.8 (12.7) - 397.5 (18-1)	3/0 Str. - 400	4-5/8	1/2-13	4	2-5/8
UP45R36R	336.4 (30-7) - 795 (30-19)	397.5 - 954	110.8 (12-7) - 447 (18-1)	3/0 Str. - 500	5-1/4	1/2-13	4	2-7/8
UP45R	336.4 (30-7) - 795 (30-19)	397.5 - 954	336.4 (30-7) - 795 (30-19)	397.5 - 954	6-1/4	5/8-11	4-1/2	3-1/4

† Accommodates compact and compressed conductors within diameter range.
To ensure proper tightening torque use BURNDY® BTW torque wrenches.

Deadend Clamp, Type BC For Guy Wire

Material: Copper

Deadend clamp for Guy Wire, Type BC is supplied with DURIMUM™ silicon bronze U-bolt, nuts, and washers. Saddle is made of high strength corrosion resistant copper alloy.

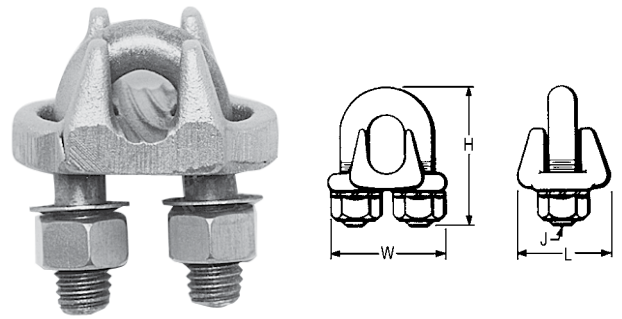

Catalog Number	Copper	Guy Wire	Dimensions			
			H	J	L	W
BC2C	2 Sol.	5/16	2	3/8	1-1/4	1-3/4
BC25	1/0 Str.	3/8			1-3/8	
BC28	2/0 Str. - 4/0 Str.	1/2	2-3/8	1/2	1-3/4	2-1/4

Deadend Thimble, Type M For Copper, Guy Wire

Material: Copper

High strength corrosion resistant copper alloy thimble groove to fit any size guy wire used for deadending. Generous radius prevents kinking or overstressing outer strands of wire.

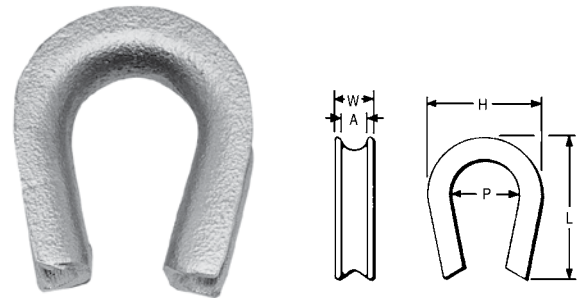

Catalog Number	Groove Size A	Dimensions			
		H	L	P	W
M20	5/16	1-5/8	1-7/8	7/8	5/8
M30	3/8	1-7/8	2-1/8	1	
M40	7/16	1-3/4	2-5/8	1-1/8	
M50	1/2	1-7/8	2-1/4		
M60	5/8	2-1/4	2-5/8	1-3/8	7/8
M70	3/4	2-5/8	3-1/4	1-1/2	1
M80	7/8	3	3-3/8	1-3/4	1-1/4
M90	1	3-3/8	3-3/4	2	1-3/8

Deadend Clamp, Type CUW-E For Copper

Material: Copper

High strength, two-bolt, cast copper alloy strain clamp with single saddle designed for short span distribution and strain bus application. Galvanized steel clevis pin, and U-bolts.

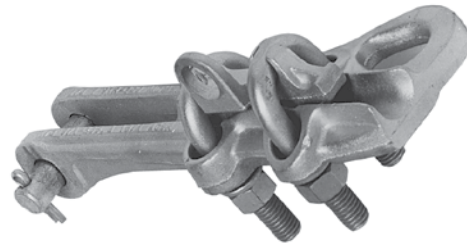

Catalog Number	Conductor Range	Dimensions		
		H	L	W
CUW34E	4/0 Str. - 500	3	7-3/8	4
CUW44E	500 - 1000	3-3/8	8-3/4	4-1/2

To ensure proper tightening torque use BURNDY® BTW torque wrenches.

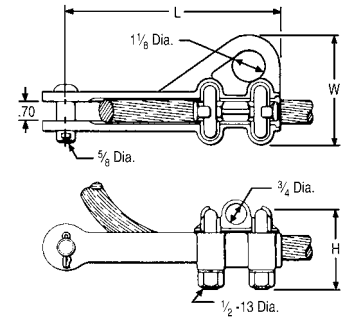

Deadend Clamp, Type DUW For Copper

Material: Copper

High strength, corrosion resistant copper alloy strain clamp with three DURIMUM™ silicon bronze U-bolts and single serrated saddle. Galvanized steel clevis pin.



Catalog Number	Conductor	Dimensions			
		H	J	L	W
DUW28	1 Str. - 4/0 Str.	2-1/2	3/8	9-7/8	2-1/4
DUW31	4/0 Str. - 350	2			2-3/8
DUW34	350-500	2-5/8	1/2		2-3/4
DUW44	500-1000	2-7/8		11-3/8	3-1/4

To ensure proper tightening torque use BURNDY® BTW torque wrenches.

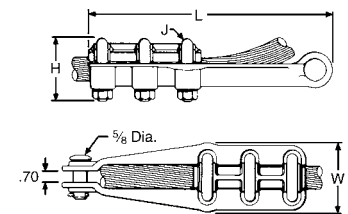

Deadend Clamp, Types CUW-A-E, CUW-R-E For AAC (Stranded, Compressed†), ACSR†, AAAC

Material: Aluminum

High strength, aluminum clamp for deadending primary distribution lines. Straight-line design with hot stick lifting-eye, pulling-eye, and captured, angled U-bolts, facilitates installation and maintenance, especially on hot-line work. Snub-pocket V-shaped, range-taking conductor groove, and galvanized steel U-bolts provide high holding strength.

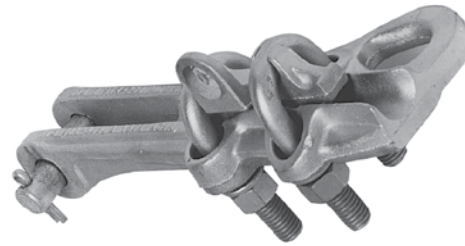

RUS Accepted

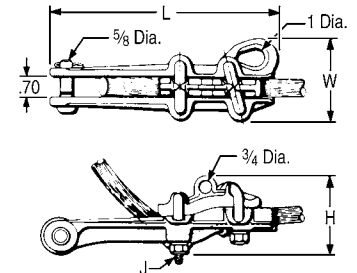

Catalog Number	Aluminum †	ACSR †, 6201, 5005	Dimensions			
			H	J	L	W
CUW26RE1	2 Str. - 2/0 (19)	4 - 2/0	3	3/8-16	8	3
CUW30AE	1/0 (7) - 300	1/0 - 266.8 (18-1)	3-5/8	1/2-13	10	3-1/2
CUW32RE	3/0 (7) - 350	3/0 - 336.4 (26-7)	4	1/2-13	10	3-5/8
CUW361RE	4/0 - 500	4/0 - 477 (18-1)	4-1/8	1/2-13	11	3-5/8
CUW391AE	336.4 - 795	300 (26-7) 636 (26-7)	4-7/8	1/2-13	11	4-1/8

† Accommodates compressed conductors within diameter range.
To ensure proper tightening torque use BURNDY® BTW torque wrenches.

Deadend Clamp, Types DUW-A, DUW-A-E For AAC (Stranded, Compressed†), ACSR†, AAAC

Material: Aluminum

High strength cast aluminum alloy clamp recommended for strain bus applications. Three galvanized steel U-bolts, single saddle, and headed clevis pin provide high holding strength. Type DUW-A-E has a pulling-eye in line with conductor for easier installation.

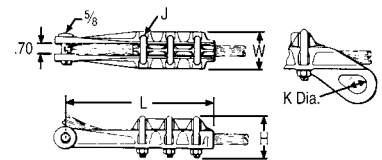
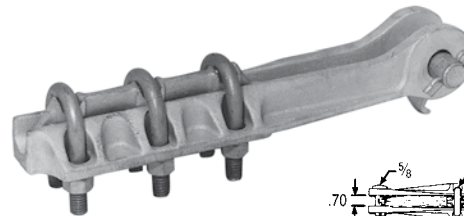

Catalog Number		Conductor		Dimensions				
Without Pulling Eye	With Pulling Eye	Aluminum †	ACSR †, 6201, 5005	H	J	K	L	W
DUW28A	—	1 - 4/0	2 (7-1) - 4/0	2	3/8	0.88	9-1/2	2-1/4
DUW44A	DUW44AE	500-1000	397.5 (30.7) - 900 (54-7)	3-3/8	1/2	1.25	11-1/4	3-5/8

† Accommodates compressed conductors within diameter range.
To ensure proper tightening torque use BURNDY® BTW torque wrenches.

Table of Contents

Compression Terminals and Accessories.....	H-77
Types YCA-2N, YCAB-4N.....	H-77
Type YCA-RL-2N.....	H-78
Types YCA-R-N, YCAK-R-N.....	H-79
Type YAK-A-2G.....	H-81
Types YCAK-A, YRA.....	H-82

Most frequently ordered catalog numbers are highlighted in BLUE

Compression Terminals and Accessories General Overview

Compression terminals are used to make convenient and reliable connections to switch pads, transformers, and other electrical equipment. They accommodate either copper, aluminum, ACSR, ACAR, Alumoweld, or steel conductor and come with one, two, or four hole NEMA drilled pads to match the equipment drilling. Standard copper and aluminum terminals are also listed in the compression section (Section C of BURNDY® Master Catalog).

HYLUG™ Terminals, Types YCA-2N, YCAB-4N For Copper

Material: Copper

Compression HYLUG™ terminals designed for terminating copper conductors to switch pads and other substation or switch yard apparatus. NEMA standard mounting holes. Made of pure copper. Installed with same die as equivalent full-tension jumper loop and repair sleeves.



Catalog Number	Conductor	Fig. No.	C	L	T	Die Index	Tool Series, Die Set Catalog Number, & (Number of Crimps)		
							MD7, MD6	35, 750, Y45†, 46‡	60
YCA252N	1/0 (7, 19)	1	7/8	5-3/8	1/8	165	W165 (3)	U165/U205 (3)	—
YCA262N	2/0 (7, 19, 37)		1	5-1/4	1/4	166	W166 (6)	U166/U459 (3)	—
YCA272N	3/0 (7, 19)		1-1/8	5-3/8		167	—	U167/U568 (3)	L167 (1)
YCA282N	4/0 (7, 12, 19)		1-1/4		3/8	168	—	U168 (3)	L168 (1)
YCAB284N	4/0 (7, 12, 19)	2	3	5-5/8		3/8	—	—	—
YCA292N	250 (7, 19, 37)	1	1-3/8		5-1/2		169	—	U169 (4)
YCA302N	300 (19, 37)		1-1/2	1/2	170	—	U170 (5)	L170 (1)	
YCA312N	350 (12, 19, 37)		1-5/8		6-1/2	267	—	U267 (6)	L267 (2)
YCA322N	400 (19, 37)	2	3	6-3/4	3/8	209	—	U209 (6)	L209 (2)
YCAB324N	400 (19, 37)			7-1/8		—	—		
YCA342N	500 (19, 37)	1	1-7/8	6-1/2	1/2	210	—	U210 (6)	L210 (2)
YCAB344N	500 (19, 37)	2	3	6-7/8	1/2	—	—	—	—
YCA392N	750 (37, 61)	2	3	7-1/4	5/8	627	—	—	L627 (3)
YCAB394N	750 (37, 61)			7-1/2		1/2	—	—	—
YCAB444N	1000 (61)			7-7/8	5/8	345	—	—	L345 (4)

YCAB have brazed pads.
† U Die with adapter PT6515
‡ U Die with adapter PUADP1

For faster installations use
BURNDY® PATRIOT® family of
battery tools, dies and cutters.

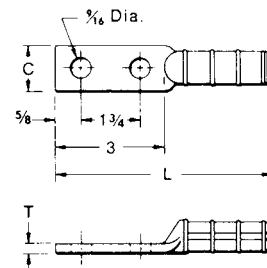

Fig. 1

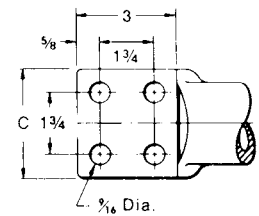

Fig. 2

HYLUG™ Terminals, Type YCA-RL-2N

For AAC (Stranded, Compressed, Compact), ACSR, AAAC

Material: Aluminum

Aluminum compression HYLUG™ for terminating overhead conductors to switch pads and other substation or switch yard apparatus. NEMA standard mounting holes. Installed with same die as equivalent full tension UNISPLICE™. Prefilled with PENETROX™ joint compound, stripsealed, and capped to limit oxide growth and increase the life of the connection.

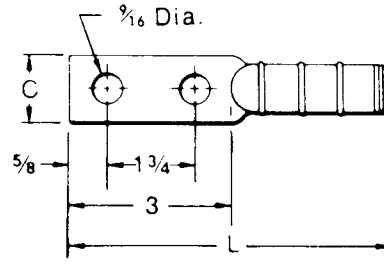
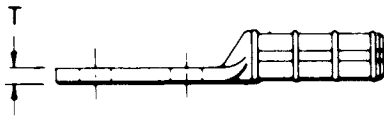

Catalog Number	Conductor	C	L	T	Die Index	Tools, Die Set Catalog Number, & (Number of Crimps)	
						MD7, MD6	35, 750, Y45†, 46‡
YCA4RL2N	4 ACSR (6-1, 7-1) 4 6201 (7) 4 AAC (7)	7/8	6	3/8	BG, 243, 687	WBG (8) Fixed BG (8) W687 (4)	U243
YCA2RL2N	2 ACSR (6-1, 7-1) 2 6201 (7) 2 AAC (7)						
YCA25RL2N	1/0 ACSR (6-1) 1/0 6201 (7) 1/0 AAC (7) 1/0 5005 (7)	1-1/8	7		C, 247, 702	WC (12) W702 (4)**	U247 (3)
YCA26RL2N	2/0 ACSR (6-1) 2/0 6201 (7) 2/0 AAC (7) 2/0 5005 (7)				6-1/2	659	U659 (3)
YCA27RL2N	3/0 ACSR (6-1) 3/0 6201 (7) 3/0 AAC (7)	1-1/4	658			U658 (3)	
YCA28RL2N	4/0 ACSR (6-1) 4/0 6201 (7) 4/0 AAC (7) 4/0 5005 (7)	1-1/2	654			U654 (3)	
YCA321RL2N	336.4 ACSR (18-1) 336.4 AAC (19) 500 AAC	1-5/8	655			U655 (3)	

† U Die with adapter PT6515.

‡ U Die with adapter PUADP1.

** MD6 NON-BOW Dies produce straight sleeves without rotating tool.

For faster installations use
BURNDY® PATRIOT® family of
battery tools, dies and cutters.



HYLUG™ Terminals, Types YCA-R-N, YCAK-R-N For AAC (Stranded, Compressed, Compact), ACSR, AAAC

Material: Aluminum

Aluminum compression HYLUG™ for terminating jumper loops and equipment taps at switchpads and other substation apparatus, or to Type YDW-R deadends. NEMA standard mounting holes. Installed with same dies as equivalent full-tension sleeves. Prefilled with PENETROX™ joint compound, stripealed, and capped to limit oxide growth and increase the life of the connection.

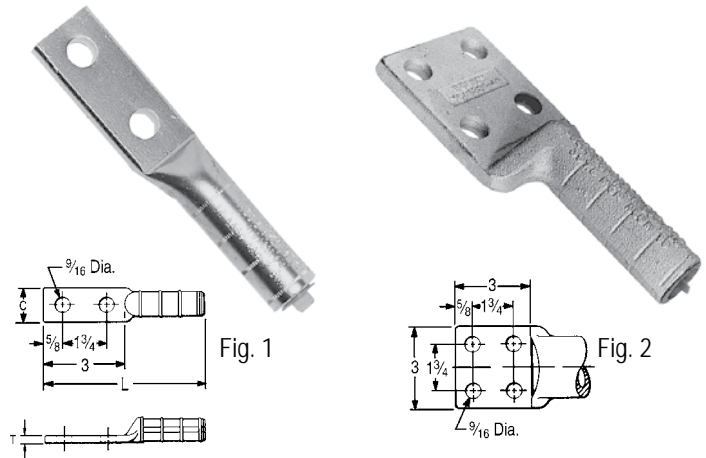

Catalog Number	Conductor		Fig No.	C	L	T	Die Index	Die Set, Tool Series Catalog Number, & (Number of Crimps)				
	ACSR, 6201, 5005	Aluminum						MD7, MD6 Series	35, 750	Y45	46	60
YCA4R2N	4	4 (7)	1	1-1/4	5-5/8	1/4	237	W237 (3)	U237 (2)	†	‡	—
YCA2R2N	2	2 (7)		7/8	6-1/4		239	W239 (3)	U239 (2)	†	‡	—
YCA25R2N	1/0	1/0 (7,19)	2	3	6-7/8	3/8	KS18 243 BG or 8A	BG (8) WBG (4)* U243 (2)	U-BG (4)	†	‡	—
YCAK25R4N				3	6-7/8	3/8		BG (8) WBG (4)* U243 (2)	U243 (2)	†	‡	L243 (1)
YCA26R2N	2/0	2/0 (7,19)	1	1	6-3/8	1/4	245AA	W245 (4)	U245 (2)	†	‡	L245 (1)
YCA27R2N	3/0 - 110.8 (12-7)	3/0 (7,19)		1-1/8	6-3/4		247	W247 (6)	U247 (3)	†	‡	L247 (2)
YCA28R2N	4/0 (6-1, 6-7)	4/0 (7,19)	2	3	7-3/8	3/8	249	K840 249 11A	U249 (3)	†	‡	L249 (2)
YCAK28R4N				3	7-3/8		249	†	‡	L249 (2)		
YCA30R2N	266.8 (18-1, 6-7 26-7)	266.8 (7,19)	2	1	1-1/2	3/8	251	—	U251 (4)	†	‡	L251 (2)
YCAK30R4N				3	7-3/8		251	—	†	‡	L251 (2)	
YCA321R2N	336.4 (18-1)	336.4 (19) - 350 (19, 37, 61)	2	1	1-1/2	7/16	321	—	U321 (4)	†	‡	L321 (2)
YCAK321R4N				3	7-1/8		321	—	†	‡	L321 (2)	
YCA33R2N	336.4 (26-7, 30-7) 397.5 (18-1)	397.5 (19)	2	1	1-5/8	3/8	316	—	U316 (4)	†	‡	L316 (2)
YCAK33R4N				3	7-3/8		316	—	†	‡	L316 (2)	
YCA35R2N	397.5 (26-7, 30-7)	477 (19, 37) - 500 (37, 61)	2	1	1-7/8	1/2	317	—	U317 (4)	†	‡	L317 (2)
YCAK35R4N				3	7-3/8		317	—	†	‡	L317 (2)	
YCA361R2N	477 (18-1)	500 (37, 61)	2	1	1-7/8	7/16	327	—	U327 (4)	†	‡	L327 (2)
YCAK361R4N				3	7-5/8		327	—	†	‡	L327 (2)	
YCA37R2N	556.5 (18-1) 477 (24-7, 26-7, 30-7)	556.5 (19, 37)	2	1	2	3/8	261	—	U261 (5)	†	‡	L261 (2)
YCAK37R4N				3	8-1/8		261	—	†	‡	L261 (2)	
YCA39R2N	556.5 (24-7, 26-7)	—	2	1	2-1/8	1/2	608	—	U608 (6)	†	‡	L608 (2)
YCAK39R4N				3	8-1/8		608	—	†	‡	L608 (2)	
YCAK361A4N	—	636 (37)	2	3	8-1/8	1/2	469	—	—	—	P469 (6)	L469 (2)

* Multiple crimp die set; makes more than one crimp per tool compression. Figure indicates number of compressions.
 † U Die with adapter PT6515.
 ‡ U Die with adapter PUADP1.
 YCA HYLUGS™ are made from heavy walled tubing.
 YCA4R-2N, YCA2R-2N and all YCAK HYLUGS™ are cast aluminum alloy.

For faster installations use BURNDY® PATRIOT® family of battery tools, dies and cutters.



(Table continued on next page.)

Overhead Distribution

Compression Terminals
Aluminum HYLUG™ Terminals Types YCA-R-N, YCAK-R-N

HYLUG™ Terminals, Types YCA-R-N, YCAK-R-N
For AAC (Stranded, Compressed, Compact), ACSR, AAAC
(Continued)

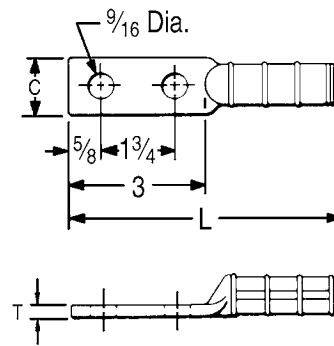

Fig. 1

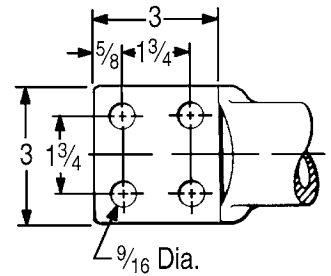

Fig. 2

Catalog Number	Conductor		Fig No.	C	L	T	Die Index	Die Set, Tools Catalog Number, & (Number of Crimps)		
	ACSR, 6201, 5005	Aluminum						Y45	46	60
YCA43R2N	605 (30-19)	795 (37, 61)	1	2-1/2	10-1/4	3/4	292 or 319	S292 (6) S319 (6)	P292 (6) P319 (6)	L292 (3) L319 (3)
YCAK43R4N	636 (24-7, 26-7, 30-19) 666.6 (24-7)	700 (61) 750 (61)	2	3	9-5/8					
YCA391A2N	—	795 (37)	1	2-3/8	10-1/8	5/8	342	S342 (6)	P342 (6)	L342 (3)
YCAK391A4N	—	750 (61)			9-7/8					
YCAK453R4N	795 (36-1) 715.5 (26-7) 795 (45-7)	—	2	3	9-5/8	5/8	292*, 578	S292 (6)	P292 (6)	L292 (3)
YCA44A2NG2	—	1000	1	2-3/8	11	5/8	342	S342 (6)	P342 (6)	L342 (3)
YCA45R2N	795 (26-7, 54-7)	900 (61, 91) 954 (37, 61)			2-1/2					
YCAK45R4N		1000 (61)	9-5/8							
YCA48R4N	900 (54-7) 954 (54-7) (45-7) 1033.5 (45-7) (36-1)	—	2	3	10	3/4	575	—	—	L575 (3)
YCA441A4N	—	1033.5 (37, 61) - 113 (61)								
YCA451A4N	1113 (54-19)	1272 (61)			10-1/4	5/8	422	—	—	L422 (3)

* Multiple crimp die set; makes more than one crimp per tool compression.
Figure indicates number of compressions.
YCA HYLUGS™ are made from heavy walled tubing.
YCA4R-2N, YCA2R-2N and all YCAK HYLUGS™ are cast aluminum alloy.

For faster installations use
BURNDY® PATRIOT® family of
battery tools, dies and cutters.



Stacking HYLUG™ Terminals, Type YAK-A-2G
For AAC (Stranded, Compressed)

Material: Aluminum

Cast aluminum HYLUG™ with a special tongue configuration for stacking of conductors on two and four hole NEMA transformer or equipment terminal pads. Up to eight conductors may be staked on one four hole NEMA pad. These stackable HYLUG™ terminals are prefilled with PENETROX™ joint compound, stripsealed, and capped to limit oxide growth and increase the life of the connection.

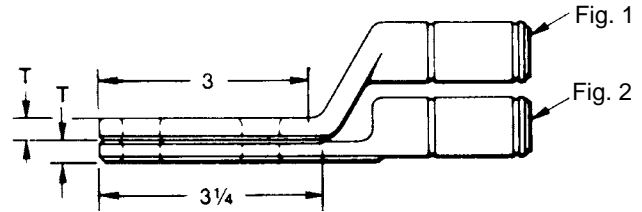
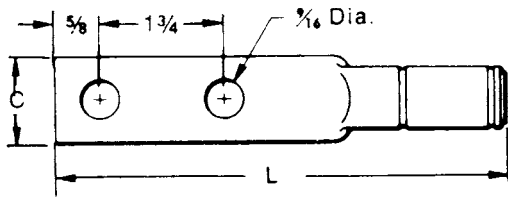
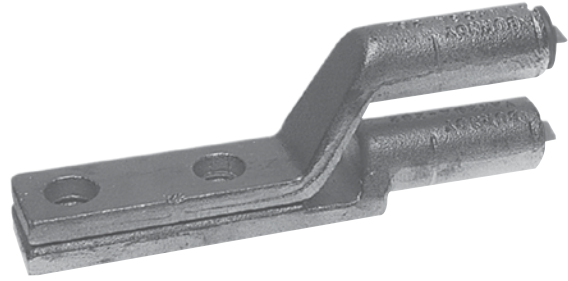

Catalog Number	Fig No.	Conductor	C	L	T	Die Index	Tool Series, Die Set & (Number of Crimps)			
							MD7, MD6 Series	35, 750	Y45	46
YAK2CA2G1	1	2 Str.	7/8	5-5/8	1/4	BG K-5/8 243	BG (3) WBG (1) W243 (1)	UBG (1) UK581T (3) U243 (1)	†	‡
YAK2CA2G2	2									
YAK25A2G1	1	1/0 Str.	7/8	5-5/8	1/4	BG K-5/8 243	BG (3) WBG (1) W243 (1)	UBG (1) UK581T (3) U243 (1)	†	‡
YAK25A2G2	2									
YAK28A2G1	1	4/0 Str.**	1-1/8	6-1/4	5/16	249 K-840	W249* WK840*	U249*	†	‡
YAK28A2G2	2									
YAK29A2G1	1	250	1-5/8	6-7/8	3/8	299 705	—	U31ART* U705	†	‡
YAK31A2G1	1	350								
YAK31A2G2	2	350	1-5/8	7-3/4	7/16	317 705	—	U317* U705*	†	‡
YAK311A2G1	1	397.5								
YAK311A2G2	2	397.5	1-5/8	7-3/4	7/16	317 705	—	U317* U705*	†	‡
YAK34A2G1	1	500								
YAK34A2G2	2	500	1-5/8	8-1/4	5/8	608 722 786	—	U608* U786*	† S786* S722*	‡ P786* P722*
YAK361A2G1	1	600								
YAK361A2G2	2	636	1-5/8	8-1/4	5/8	608 722 786	—	U608* U786*	† S786* S722*	‡ P786* P722*
YAK39A2G1	1	700								
YAK39A2G2	2	750	1-5/8	8-1/4	5/8	608 722 786	—	U608* U786*	† S786* S722*	‡ P786* P722*
YAK44A2NG8	1	1000								
YAK44A2NG7	2	1000	1-5/8	8-7/8	—	302	—	S44ART*	—	P44ART*

* Overlap crimps.
** Accommodates 4/0 Str., Al or Cu.
† U Die with adapter PT6515.
‡ U Die with adapter PUADP1.

For faster installations use
BURNDY® PATRIOT® family of
battery tools, dies and cutters.



Aluminum HYLUG™ Terminals, Types YCAK-A, YRA For AAC (Stranded, Compressed), ACSR, Copper

Material: Aluminum

Aluminum HYLUG™ terminals for joining aluminum and copper cable to transformer and equipment pads. HYLUG™ terminals are pre-filled with PENETROX™ joint compound, stripsealed, and capped to limit oxide growth and increase the life of the connection. Installed with standard tooling, five die sets install fourteen terminal sizes.

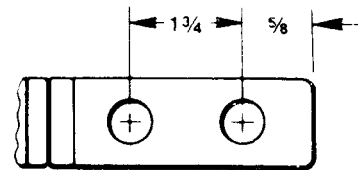
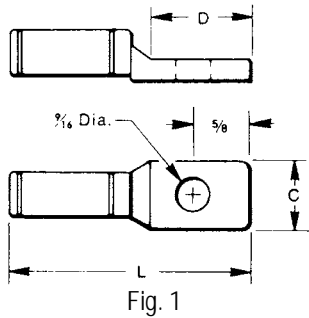
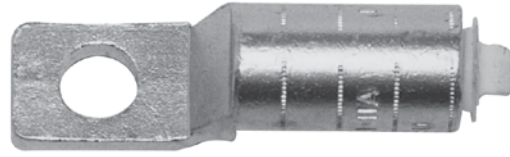

Fig. 2

Catalog Number	Fig No.	Conductor			C	D	L	Die Index	Die Set, Tool Catalog Number & (Number of Crimps)					
		Copper	Aluminum Conc. & Compact	ACSR					MD7, MD6 Series	35, 750	Y45	46		
YRA8CU1	1	6 Sol. - 8 Sol.	8 Str.	—	15/16	1-1/16	2-9/16	BG 243	BG (3) K 5/8 243 (1)	UBG (1) UK5/81T (3) U243 (1)	†	‡		
YRA6CU1		4 Sol. - 6 Str.	4 Sol. - 6 Str.	6 (6-1)										
YRA4CU1		2 Sol. - 4 Str.	2 Sol. - 4 Str.	4 (6-1, 7-1)										
YRA1CU1		1 Str. - 2 Str.	1 Str. - 2 Str.**	2 (6-1, 7-1)										
YRA25A1		—	1/0 Str.	—		1-1/4	3-1/4	249 K840	W249* WK840*	U249* UK840	†	‡		
YRAL4CU		2 Sol. - 4 Str.	2 Sol. - 4 Str.	4 (6-1, 7-1)										
YRAL1CU		1 Str. - 2 Str.	1 Str. - 2 Str.	2 (6-1, 7-1)										
YRA25U		1/0 Str.	1/0 Str.	1/0 (6-1)										
YRA26U		2/0 Str.	2/0 Str.	2/0 (6-1)										
YRA27U		3/0 Str.	3/0 Str.	—										
YRA28U		4/0 Str.	4/0 Str.	—		1-1/4	3	5-5/8	317 705	—	U317* U705*	† S705*	‡ P705*	
YCAK28A2G1*		4/0 Str.	4/0 Str.	—										
YCAK29A2G1*	250	250	4/0 (6-1)											
YCAK31AG1*	350	350	—											
YCAK31A2G1*	2	500	500	—	1-1/2	3	608 786	—	U608* U786*	† S786*	‡ P786*			
YCAK34A2G3*												—	600	—
YCAK36A2G1*												—	750	—
YCAK39A2G2*												—	1000	—
YCAK44A2G2*	—	—	—	1-11/16	—	7-1/2	302	—	—	S44ART*	P44ART*			

* Overlap crimps.

** YRA1CU-1 not recommended for 2 comp. conductor.

† U Die with adapter PT6515.

‡ U Die with adapter PUADP1.

For faster installations use
BURNDY® PATRIOT® family of
battery tools, dies and cutters.



Table of Contents

Full Tension EHV Splice Kits for ACSR ConductorI-3

Terminals for ACSR ConductorI-4

Terminals, EHV, for ACSR ConductorI-5

Jumper Sleeves, EHV, for ACSR ConductorI-6

Full Tension EHV Splice Kits for ACSS ConductorI-7

Terminals for ACSS ConductorI-8

Terminals, EHV, for ACSS ConductorI-9

Jumper Sleeves, EHV, for ACSS ConductorI-10

Full Tension EHV Splices for AAC / ACAR ConductorI-11

Terminals for ACAR Stranded Aluminum CableI-12

Terminals, EHV, for ACAR Stranded Aluminum CableI-13

Jumper Sleeves, EHV, for ACAR Stranded Aluminum CableI-14

Terminals for Alumoweld, EHS SteelI-15

Full Tension Sleeves for AlumoweldI-16

Full Tension Splices for EHS Steel Guy, Messenger, "Static" CableI-17

Full Tension Deadend Kits for ACCC® ConductorI-18

Full Tension Compression Splice Kits for ACCC® ConductorI-20

Terminals for ACCC® ConductorI-21

T-Tap with Pad Connectors for ACCC® ConductorI-23

Repair Sleeves for ACCC® ConductorI-24

Terminal Pad Caps (one piece)I-25

Bolted Bundled Cable SpacersI-26

Bolted Bundled Cable Spacers (Three Conductor)I-28

ACCC is a Registered Trade Mark of CTC Cable Corp.

This page intentionally left blank

Type YTS-RT-RS EHV

Full Tension EHV Splice Kit for ACSR Conductor

Full tension, two-piece, compression splice for ACSR transmission lines at 345 kV and over. Outer aluminum sleeve has filler hole and plug for PENETROX™ joint compound. Kit includes the outer aluminum and inner steel sleeves.

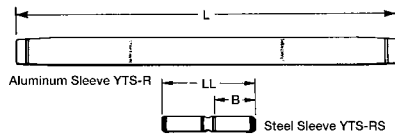

Conductor Name	Size kcmil	ACSR Stranding		Splice Kit	Aluminum Sleeve			Steel Sleeve		
		Alum.	Steel		Inches		Die*‡	Inches		Die*
					L	O.D.		LL	B	
Linnet	336.4	26	7	YTS32RT34RS	17.92	1.19	L717	5.74	2.45	L718
Oriole	336.4	30	7	YTS32RT33RS	17.92	1.19	L717	5.74	2.45	L718
Ibis	397.5	26	7	YTS34RT34RS	17.92	1.28	L719	5.74	2.45	L718
Flicker	477	24	7	YTS36RT362RS	18.92	1.41	L720	5.88	2.46	L721
Hawk	477	26	7	YTS36RT36RS	18.92	1.41	L720	5.76	2.46	L721
Parakeet	556.5	24	7	YTS39RT43RS	20.74	1.50	L722	5.90	2.47	L723
Dove	556.5	26	7	YTS39RT43RS	20.74	1.50	L722	5.90	2.47	L723
Peacock	605	24	7	YTS43RT43RS	22.28	1.61	L724	5.90	2.47	L723
Squab	605	26	7	YTS43RT43RS	22.28	1.61	L724	5.90	2.47	L723
Rook	636	24	7	YTS43RT43RS	22.28	1.61	L724	5.90	2.47	L723
Grosbeak	636	26	7	YTS43RT43RS	22.28	1.61	L724	5.90	2.47	L723
Flamingo	666.6	24	7	YTS43RT43RS	22.28	1.61	L724	5.90	2.47	L723
Starling	715.5	26	7	YTS451RT48RS	28.96	1.80	L725	9.00	4.00	L726
Cuckoo	795	24	7	YTS451RT449RS	28.96	1.80	L725	9.00	4.00	L726
Drake	795	26	7	YTS451RT48RS	28.96	1.80	L725	9.00	4.00	L726
Tern	795	45	7	YTS451RT481RS	28.96	1.80	L725	9.00	4.00	L726
Condor	795	54	7	YTS451RT449RS	28.96	1.80	L725	9.00	4.00	L726
Rail	954	45	7	YTS48RT481RS	29.16	1.97	L727	9.00	4.01	L726
Cardinal	954	54	7	YTS48RT48RS	29.16	1.97	L727	9.00	4.00	L726
Ortolan	1033.5	45	7	YTS49RT483RS	29.02	1.97	L727	9.00	4.01	L726
Curlew	1033.5	54	7	YTS49RT48RS	29.02	1.97	L727	9.00	4.00	L726
Bluejay	1113	45	7	YTS49RT483RS	29.02	1.97	L727	9.00	4.01	L726
Finch	1113	54	19	YTS52RT48RS	42.33	2.25	L728	9.00	4.00	L726
Bunting	1192.5	45	7	YTS52RT521RS	42.33	2.25	L728	9.00	4.00	L726
Bittern	1272	45	7	YTS52RT521RS	42.33	2.25	L728	9.00	4.00	L726
Pheasant	1272	54	19	YTS52RT59RS	42.33	2.25	L728	9.00	4.07	L726
Dipper	1351.5	45	7	YTS52RT521RS	42.33	2.25	L728	9.00	4.00	L726
Martin	1351.5	54	19	YTS52RT59RS	42.33	2.25	L728	9.00	4.07	L726
Nuthatch	1510.5	45	7	YTS549RT521RS	34.13	2.50	L729	9.00	4.00	L726
Parrot	1510.5	54	19	YTS549RT59RS	34.13	2.50	L729	9.10	4.07	L726
Lapwing	1590	45	7	YTS549RT549RS	34.13	2.50	L729	9.00	4.00	L726
Falcon	1590	54	19	YTS56RT59RS	34.13	2.50	L729	9.10	4.07	L726
Chukar	1780	84	19	YTS58RT48RS	35.46	2.50	L735	9.00	4.00	L726
Bluebird	2156	84	19	YTS59RT59RS	42.91	2.50	L735	9.10	4.07	L726
Kiwi	2167	72	7	YTS59RT521RS	42.91	2.50	L735	9.00	4.00	L726

Splice Kit: Includes aluminum sleeve and steel sleeve.

* Overlap crimps.

‡ Wide dies may be used on aluminum only (no steel), add suffix "W" to part number (example: L725W).

NOTE: Remove "T" from middle of part number for non-EHV <230kV version. (Example: YTS56R59RS)

Types YNA-R15, YNA-R

Compression Terminals for ACSR Conductor

Compression terminal for ACSR transmission lines up to and including 230 kV. Two hole NEMA tongue through 556.5 kcmil and four hole on larger sizes. Includes PENETROX™ joint compound in barrel and oxide retardant on pad.

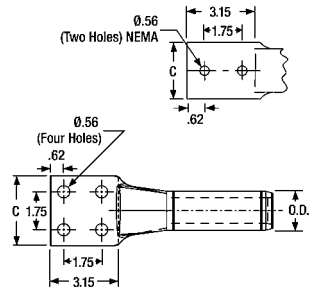
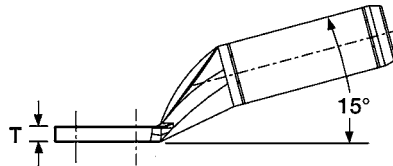
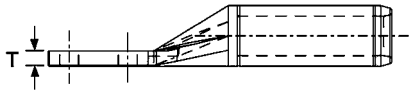

Conductor Name	ACSR		Stranding		15° Terminal		Straight Terminal		Inches		Die*†
	Size kcmil	Alum.	Steel	Catalog Number	Inches L	Catalog Number	Inches L	C†	T		
Linnet	336.4	26	7	YNA32R15	8.92	YNA32R	8.96	1.68	0.39	L717	
Oriole	336.4	30	7	YNA32R15	8.92	YNA32R	8.96	1.68	0.39	L717	
Ibis	397.5	26	7	YNA34R15	9.31	YNA34R	9.08	1.78	0.46	L719	
Flicker	477	24	7	YNA36R15	9.62	YNA36R	9.47	1.96	0.48	L720	
Hawk	477	26	7	YNA36R15	9.62	YNA36R	9.47	1.96	0.48	L720	
Parakeet	556.5	24	7	YNA39R15	10.09	YNA39R	9.84	2.08	0.53	L722	
Dove	556.5	26	7	YNA39R15	10.09	YNA39R	9.84	2.08	0.53	L722	
Peacock	605	24	7	YNA43R15	10.16	YNA43R	10.07	3.07	0.36	L724	
Squab	605	26	7	YNA43R15	10.16	YNA43R	10.07	3.07	0.36	L724	
Rook	636	24	7	YNA43R15	10.16	YNA43R	10.07	3.07	0.36	L724	
Grosbeak	636	26	7	YNA43R15	10.16	YNA43R	10.07	3.07	0.36	L724	
Flamingo	666.6	24	7	YNA43R15	10.16	YNA43R	10.07	3.07	0.36	L724	
Starling	715.5	26	7	YNA451R15	10.21	YNA451R	10.28	3.22	0.45	L725	
Cuckoo	795	24	7	YNA451R15	10.21	YNA451R	10.28	3.22	0.45	L725	
Drake	795	26	7	YNA451R15	10.21	YNA451R	10.28	3.22	0.45	L725	
Tern	795	45	7	YNA451R15	10.21	YNA451R	10.28	3.22	0.45	L725	
Condor	795	54	7	YNA451R15	10.21	YNA451R	10.28	3.22	0.45	L725	
Ruddy	900	45	7	YNA49R15	10.35	YNA49R	10.46	3.22	0.52	L727	
Rail	954	45	7	YNA49R15	10.35	YNA49R	10.46	3.22	0.52	L727	
Cardinal	954	54	7	YNA49R15	10.35	YNA49R	10.46	3.22	0.52	L727	
Ortolan	1033.5	45	7	YNA49R15	10.35	YNA49R	10.46	3.22	0.52	L727	
Curlew	1033.5	54	7	YNA49R15	10.35	YNA49R	10.46	3.22	0.52	L727	
Bluejay	1113	45	7	YNA49R15	10.35	YNA49R	10.46	3.22	0.52	L727	
Finch	1113	54	19	YNA52R15	12.09	YNA52R	12.24	3.22	0.71	L728	
Bunting	1192.5	45	7	YNA52R15	12.09	YNA52R	12.24	3.22	0.71	L728	
Bittern	1272	45	7	YNA52R15	12.09	YNA52R	12.24	3.22	0.71	L728	
Pheasant	1272	54	19	YNA52R15	12.09	YNA52R	12.24	3.22	0.71	L728	
Dipper	1351.5	45	7	YNA52R15	12.09	YNA52R	12.24	3.22	0.71	L728	
Martin	1351.5	54	19	YNA52R15	12.09	YNA52R	12.24	3.22	0.71	L728	
Nuthatch	1510.5	45	7	YNA56R15	12.50	YNA56R	12.74	3.44	0.81	L729	
Parrot	1510.5	54	19	YNA56R15	12.50	YNA56R	12.74	3.44	0.81	L729	
Lapwing	1590	45	7	YNA56R15	12.50	YNA56R	12.74	3.44	0.81	L729	
Falcon	1590	54	19	YNA56R15	12.50	YNA56R	12.74	3.44	0.81	L729	
Chukar	1780	84	19	YNA58R15	13.25	YNA58R	13.34	3.47	0.76	L735	
Bluebird	2156	84	19	YNA59R15	13.12	YNA59R	13.25	3.57	0.61	L735	
Kiwi	2167	72	7	YNA59R15	13.12	YNA59R	13.25	3.57	0.61	L735	

† Two hole NEMA pads standard on conductors up to 556.5 kcmil; Four hole NEMA pads on larger conductor sizes.
To specify hardware for bolting to corresponding Deadends add the suffix H to the catalog number (example: YNA52RH).
* Overlap crimps.
‡ Wide dies may be used on aluminum only (no steel), add suffix "W" to part number (example: L725W).

Types YNA-RT15, YNA-RT EHV
Compression Terminals for ACSR Conductor

Compression terminal for ACSR transmission lines at 345 kV and over. Two hole NEMA tongue supplied through 636 kcmil and four hole on larger sizes. Includes PENETROX™ joint compound in barrel and oxide retardant on pad.

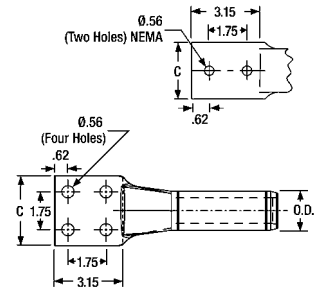
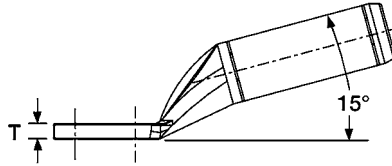
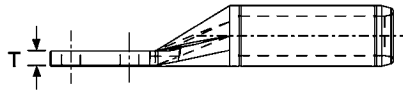

Conductor Name	ACSR		15° Terminal		Straight Terminal		Inches		Die†‡	
	Size kcmil	Stranding		Catalog Number	Inches L	Catalog Number	Inches L	C†		T
		Alum.	Steel							
Linnnet	336.4	26	7	YNA32RT15	9.04	YNA32RT	9.14	1.68	0.39	L717
Oriole	336.4	30	7	YNA32RT15	9.04	YNA32RT	9.14	1.68	0.39	L717
Ibis	397.5	26	7	YNA34RT15	9.21	YNA34RT	9.3	1.78	0.46	L719
Flicker	477	24	7	YNA36RT15	9.63	YNA36RT	9.7	1.96	0.48	L720
Hawk	477	26	7	YNA36RT15	9.63	YNA36RT	9.7	1.96	0.48	L720
Parakeet	556.5	24	7	YNA39RT15	10.02	YNA39RT	10.09	2.08	0.53	L722
Dove	556.5	26	7	YNA39RT15	10.02	YNA39RT	10.09	2.08	0.53	L722
Peacock	605	24	7	YNA43RT15	10.21	YNA43RT	10.32	3.22	0.36	L724
Squab	605	26	7	YNA43RT15	10.21	YNA43RT	10.32	3.22	0.36	L724
Rook	636	24	7	YNA43RT15	10.21	YNA43RT	10.32	3.22	0.36	L724
Grosbeak	636	26	7	YNA43RT15	10.21	YNA43RT	10.32	3.22	0.36	L724
Flamingo	666.6	24	7	YNA43RT15	10.21	YNA43RT	10.32	3.22	0.36	L724
Starling	715.5	26	7	YNA451RT15	10.65	YNA451RT	10.57	3.22	0.45	L725
Cuckoo	795	24	7	YNA451RT15	10.65	YNA451RT	10.57	3.22	0.45	L725
Drake	795	26	7	YNA451RT15	10.65	YNA451RT	10.57	3.22	0.45	L725
Tern	795	45	7	YNA451RT15	10.65	YNA451RT	10.57	3.22	0.45	L725
Condor	795	54	7	YNA451RT15	10.65	YNA451RT	10.57	3.22	0.45	L725
Ruddy	900	45	7	YNA49RT15	10.94	YNA49RT	10.77	3.22	0.52	L727
Rail	954	45	7	YNA49RT15	10.94	YNA49RT	10.77	3.22	0.52	L727
Cardinal	954	54	7	YNA49RT15	10.94	YNA49RT	10.77	3.22	0.52	L727
Oortolan	1033.5	45	7	YNA49RT15	10.94	YNA49RT	10.77	3.22	0.52	L727
Curlew	1033.5	54	7	YNA49RT15	10.94	YNA49RT	10.77	3.22	0.52	L727
Bluejay	1113	45	7	YNA49RT15	10.94	YNA49RT	10.77	3.22	0.52	L727
Finch	1113	54	19	YNA52RT15	12.62	YNA52RT	13.82	3.22	0.71	L728
Bunting	1192.5	45	7	YNA52RT15	12.62	YNA52RT	13.82	3.22	0.71	L728
Bittern	1272	45	7	YNA52RT15	12.62	YNA52RT	13.82	3.22	0.71	L728
Pheasant	1272	54	19	YNA52RT15	12.62	YNA52RT	13.82	3.22	0.71	L728
Dipper	1351.5	45	7	YNA52RT15	12.62	YNA52RT	13.82	3.22	0.71	L728
Martin	1351.5	54	19	YNA52RT15	12.62	YNA52RT	13.82	3.22	0.71	L728
Nuthatch	1510.5	45	7	YNA56RT15	13.36	YNA56RT	13.76	3.44	0.86	L729
Parrot	1510.5	54	19	YNA56RT15	13.36	YNA56RT	13.76	3.44	0.86	L729
Lapwing	1590	45	7	YNA56RT15	13.36	YNA56RT	13.76	3.44	0.86	L729
Falcon	1590	54	19	YNA56RT15	13.36	YNA56RT	13.76	3.44	0.86	L729
Chukar	1780	84	19	YNA58RT15	14.08	YNA58RT	13.7	3.47	0.80	L735
Bluebird	2156	84	19	YNA59RT15	13.75	YNA59RT	13.54	3.57	0.64	L735
Kiwi	2167	72	7	YNA59RT15	13.75	YNA59RT	13.54	3.57	0.64	L735

† Two hole NEMA pads standard for conductors up to 556.5 kcmil; Four hole NEMA pads on larger conductor sizes. Shielding cap STS43A-4N required for EHV applications (two caps required). To specify hardware for bolting to corresponding Deadends add the suffix H to catalog number (example: YNA52RTH).

* Overlap crimps.

‡ Wide dies may be used on aluminum only (no steel), add suffix "W" to part number (example: L725W).

Type YNS-RT EHV Jumper Loop Sleeve for ACSR Conductor

Compression terminal for ACSR transmission lines over 230 kV. Sleeve is pre-filled with PENETROX™ joint compound and capped.

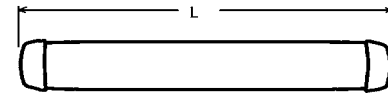

Conductor Name	ACSR		Jumper Sleeve	Inches		Die*†	
	Size kcmil	Stranding		L	O.D.		
		Alum.					Steel
Linnet	336.4	26	7	YNS32RT	8.96	1.19	L717
Oriole	336.4	30	7	YNS32RT	8.96	1.19	L717
Ibis	397.5	26	7	YNS34RT	9.10	1.30	L719
Flicker	477	24	7	YNS36RT	9.64	1.41	L720
Hawk	477	26	7	YNS36RT	9.64	1.41	L720
Parakeet	556.5	24	7	YNS39RT	10.26	1.50	L722
Dove	556.5	26	7	YNS39RT	10.26	1.50	L722
Peacock	605	24	7	YNS43RT	10.48	1.61	L724
Squab	605	26	7	YNS43RT	10.48	1.61	L724
Rook	636	24	7	YNS43RT	10.48	1.61	L724
Grosbeak	636	26	7	YNS43RT	10.48	1.61	L724
Flamingo	666.6	24	7	YNS43RT	10.48	1.61	L724
Starling	715.5	26	7	YNS451RT	10.60	1.80	L725
Cuckoo	795	24	7	YNS451RT	10.60	1.80	L725
Drake	795	26	7	YNS451RT	10.60	1.80	L725
Tern	795	45	7	YNS451RT	10.60	1.80	L725
Condor	795	54	7	YNS451RT	10.60	1.80	L725
Ruddy	900	45	7	YNS49RT	10.66	1.97	L727
Rail	954	45	7	YNS49RT	10.66	1.97	L727
Cardinal	954	54	7	YNS49RT	10.66	1.97	L727
Ortolan	1033.5	45	7	YNS49RT	10.66	1.97	L727
Curlew	1033.5	54	7	YNS49RT	10.66	1.97	L727
Bluejay	1113	45	7	YNS49RT	10.66	1.97	L727
Finch	1113	54	19	YNS52RT	16.20	2.25	L728
Bunting	1192.5	45	7	YNS52RT	16.20	2.25	L728
Bittern	1272	45	7	YNS52RT	16.20	2.25	L728
Pheasant	1272	54	19	YNS52RT	16.20	2.25	L728
Dipper	1351.5	45	7	YNS52RT	16.20	2.25	L728
Martin	1351.5	54	19	YNS52RT	16.20	2.25	L728
Nuthatch	1510.5	45	7	YNS56RT	15.58	2.50	L729
Parrot	1510.5	54	19	YNS56RT	15.58	2.50	L729
Lapwing	1590	45	7	YNS56RT	15.58	2.50	L729
Falcon	1590	54	19	YNS56RT	15.58	2.50	L729
Chukar	1780	84	19	YNS58RT	15.46	2.50	L735
Bluebird	2156	84	19	YNS59RT	15.14	2.50	L735
Kiwi	2167	72	7	YNS59RT	15.14	2.50	L735

* Overlap crimps.

† Wide dies may be used on aluminum only, add suffix "W" to part number (example: L725W).

NOTE: Remove "T" suffix for part number for non-EHV <230kV version. (Example: YNS58R)

Type YTS-RT-RSHT EHV
Full Tension EHV Splice Kit for ACSS Conductor

Full tension, two-piece, compression splice for 250° C ACSS transmission lines at 345 kV and over. Outer aluminum sleeve has filler hole and plug for PENETROX™ joint compound. Kit includes the outer aluminum and inner steel sleeves.

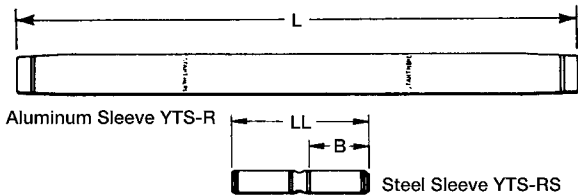
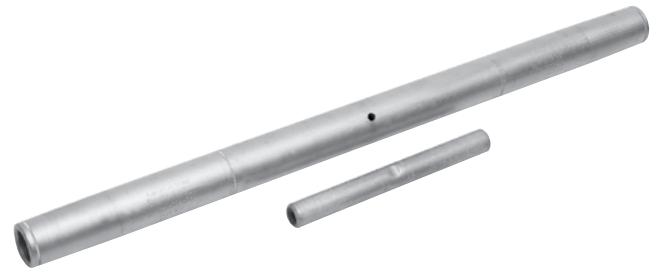

Conductor Name	ACSS		Splice Kit	Aluminum Sleeve			Steel Sleeve			
	Size kcmil	Stranding		Inches		Die* ‡	Inches		Die*	
		Alum.		Steel	L		O.D.	LL		B
Linnet	336.4	26	7	YTS32RT34RSHT	25.92	1.19	L717	5.74	2.45	L718
Oriole	336.4	30	7	YTS32RT33RSHT	25.92	1.19	L717	5.74	2.45	L718
Ibis	397.5	26	7	YTS34RT34RSHT	25.92	1.28	L719	5.74	2.45	L718
Flicker	477	24	7	YTS36RT362RSHT	26.92	1.41	L720	5.88	2.46	L721
Hawk	477	26	7	YTS36RT36RSHT	26.92	1.41	L720	5.76	2.46	L721
Parakeet	556.5	24	7	YTS39RT43RSHT	28.74	1.50	L722	5.90	2.47	L723
Dove	556.5	26	7	YTS39RT43RSHT	28.74	1.50	L722	5.90	2.47	L723
Peacock	605	24	7	YTS43RT43RSHT	30.28	1.61	L724	5.90	2.47	L723
Squab	605	26	7	YTS43RT43RSHT	30.28	1.61	L724	5.90	2.47	L723
Rook	636	24	7	YTS43RT43RSHT	30.28	1.61	L724	5.90	2.47	L723
Grosbeak	636	26	7	YTS43RT43RSHT	30.28	1.61	L724	5.90	2.47	L723
Flamingo	666.6	24	7	YTS43RT43RSHT	30.28	1.61	L724	5.90	2.47	L723
Starling	715.5	26	7	YTS451RT48RSHT	36.96	1.80	L725	9.00	4.00	L726
Cuckoo	795	24	7	YTS451RT449RSHT	36.96	1.80	L725	9.00	4.00	L726
Drake	795	26	7	YTS451RT48RSHT	36.96	1.80	L725	9.00	4.00	L726
Tern	795	45	7	YTS451RT481RSHT	36.96	1.80	L725	9.00	4.00	L726
Condor	795	54	7	YTS451RT449RSHT	36.96	1.80	L725	9.00	4.00	L726
Rail	954	45	7	YTS48RT481RSHT	37.96	1.97	L727	9.00	4.01	L726
Cardinal	954	54	7	YTS48RT48RSHT	37.96	1.97	L727	9.00	4.01	L726
Ortolan	1033.5	45	7	YTS49RT483RSHT	37.02	1.97	L727	9.00	4.01	L726
Curlew	1033.5	54	7	YTS49RT48RSHT	37.02	1.97	L727	9.00	4.00	L726
Bluejay	1113	45	7	YTS49RT483RSHT	37.02	1.97	L727	9.00	4.01	L726
Finch	1113	54	19	YTS52RT48RSHT	50.33	2.25	L728	9.00	4.00	L726
Bunting	1192.5	45	7	YTS52RT521RSHT	50.33	2.25	L728	9.00	4.00	L726
Bittern	1272	45	7	YTS52RT521RSHT	50.33	2.25	L728	9.00	4.00	L726
Pheasant	1272	54	19	YTS52RT59RSHT	50.33	2.25	L728	9.10	4.07	L726
Dipper	1351.5	45	7	YTS52RT521RSHT	50.33	2.25	L728	9.00	4.00	L726
Martin	1351.5	54	19	YTS52RT59RSHT	50.33	2.25	L728	9.10	4.07	L726
Nuthatch	1510.5	45	7	YTS549RT521RSHT	42.13	2.50	L729	9.00	4.00	L726
Parrot	1510.5	54	19	YTS549RT59RSHT	42.13	2.50	L729	9.10	4.07	L726
Lapwing	1590	45	7	YTS549RT549RSHT	42.13	2.50	L729	9.00	4.00	L726
Falcon	1590	54	19	YTS56RT59RSHT	42.13	2.50	L729	9.10	4.07	L726
Chukar	1780	84	19	YTS58RT48RSHT	43.46	2.50	L735	9.00	4.00	L726
Bluebird	2156	84	19	YTS59RT59RSHT	50.91	2.50	L735	9.10	4.07	L726
Kiwi	2167	72	7	YTS59RT521RSHT	50.91	2.50	L735	9.00	4.00	L726

Splice Kit: Includes aluminum sleeve and steel sleeve.

* Overlap crimps.

‡ Wide dies may be used on aluminum only (no steel), add suffix "W" to part number (example: L725W).

NOTE: Remove "T" from middle of part number for non-EHV <230kV version. (Example: YTS56R59RSHT)

Types BYNA-R15HT, BYNA-RHT Compression Terminals for ACSS Conductor

Compression terminal for ACSS transmission lines up to and including 230 kV.

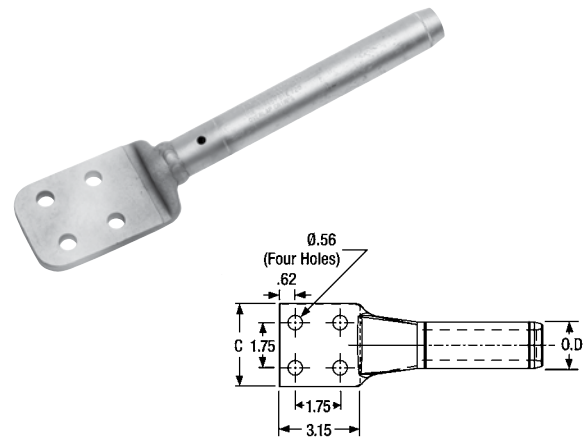
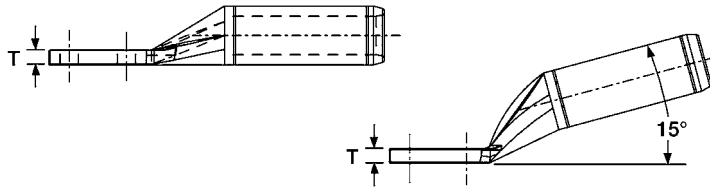

Conductor Name	ACSS Size kcmil	Stranding		15° Terminal		Straight Terminal		Inches			Die†‡
		Alum.	Steel	Catalog Number	Inches L	Catalog Number	Inches L	C	D	T	
Linnet	336.4	26	7	BYNA32R15HT	16.21	BYNA32RHT	16.56	3.25	4.50	0.75	L717
Oriole	336.4	30	7	BYNA32R15HT	16.21	BYNA32RHT	16.56	3.25	4.50	0.75	L717
Ibis	397.5	26	7	BYNA34R15HT	16.24	BYNA34RHT	16.60	3.25	4.50	0.75	L719
Flicker	477	24	7	BYNA36R15HT	16.51	BYNA36RHT	16.92	3.25	4.50	0.75	L720
Hawk	477	26	7	BYNA36R15HT	16.51	BYNA36RHT	16.92	3.25	4.50	0.75	L720
Parakeet	556.5	24	7	BYNA39R15HT	16.89	BYNA39RHT	17.30	3.25	4.50	0.75	L722
Dove	556.5	26	7	BYNA39R15HT	16.89	BYNA39RHT	17.30	3.25	4.50	0.75	L722
Peacock	605	24	7	BYNA43R15HT	14.41	BYNA43RHT	15.46	3.07	3.95	0.36	L724
Squab	605	26	7	BYNA43R15HT	14.41	BYNA43RHT	15.46	3.07	3.95	0.36	L724
Rook	636	24	7	BYNA43R15HT	14.41	BYNA43RHT	15.46	3.07	3.95	0.36	L724
Grosbeak	636	26	7	BYNA43R15HT	14.41	BYNA43RHT	15.46	3.07	3.95	0.36	L724
Flamingo	666.6	24	7	BYNA43R15HT	14.41	BYNA43RHT	15.46	3.07	3.95	0.36	L724
Starling	715.5	26	7	BYNA451R15HT	15.10	BYNA451RHT	15.46	3.22	3.95	0.45	L725
Cuckoo	795	24	7	BYNA451R15HT	15.10	BYNA451RHT	15.46	3.22	3.95	0.45	L725
Drake	795	26	7	BYNA451R15HT	15.10	BYNA451RHT	15.46	3.22	3.95	0.45	L725
Tern	795	45	7	BYNA451R15HT	15.10	BYNA451RHT	15.46	3.22	3.95	0.45	L725
Condor	795	54	7	BYNA451R15HT	15.10	BYNA451RHT	15.46	3.22	3.95	0.45	L725
Ruddy	900	45	7	BYNA49R15HT	15.14	BYNA49RHT	15.66	3.22	3.95	0.52	L727
Rail	954	45	7	BYNA49R15HT	15.14	BYNA49RHT	15.66	3.22	3.95	0.52	L727
Cardinal	954	54	7	BYNA49R15HT	15.14	BYNA49RHT	15.66	3.22	3.95	0.52	L727
Ortolan	1033.5	45	7	BYNA49R15HT	15.14	BYNA49RHT	15.66	3.22	3.95	0.52	L727
Curlew	1033.5	54	7	BYNA49R15HT	15.14	BYNA49RHT	15.66	3.22	3.95	0.52	L727
Bluejay	1113	45	7	BYNA49R15HT	15.14	BYNA49RHT	15.66	3.22	3.95	0.52	L727
Finch	1113	54	19	BYNA52R15HT	16.81	BYNA52RHT	18.71	3.22	3.95	0.71	L728
Bunting	1192.5	45	7	BYNA52R15HT	16.81	BYNA52RHT	18.71	3.22	3.95	0.71	L728
Bittern	1272	45	7	BYNA52R15HT	16.81	BYNA52RHT	18.71	3.22	3.95	0.71	L728
Pheasant	1272	54	19	BYNA52R15HT	16.81	BYNA52RHT	18.71	3.22	3.95	0.71	L728
Dipper	1351.5	45	7	BYNA52R15HT	16.81	BYNA52RHT	18.71	3.22	3.95	0.71	L728
Martin	1351.5	54	19	BYNA52R15HT	16.81	BYNA52RHT	18.71	3.22	3.95	0.71	L728
Nuthatch	1510.5	45	7	BYNA56R15HT	17.56	BYNA56RHT	18.65	3.44	3.95	0.86	L729
Parrot	1510.5	54	19	BYNA56R15HT	17.56	BYNA56RHT	18.65	3.44	3.95	0.86	L729
Lapwing	1590	45	7	BYNA56R15HT	17.56	BYNA56RHT	18.65	3.44	3.95	0.86	L729
Falcon	1590	54	19	BYNA56R15HT	17.56	BYNA56RHT	18.65	3.44	3.95	0.86	L729
Chukar	1780	84	19	BYNA58R15HT	18.28	BYNA58RHT	18.59	3.47	3.95	0.80	L735
Bluebird	2156	84	19	BYNA59R15HT	17.95	BYNA59RHT	18.43	3.57	3.95	0.64	L735
Kiwi	2167	72	7	BYNA59R15HT	17.95	BYNA59RHT	18.43	3.57	3.95	0.64	L735

To specify hardware for bolting to corresponding dead-ends add the suffix "H" to the catalog number (example: BYNA52RHHT).

* Overlap crimps.

‡ Wide dies may be used on aluminum only (no steel), add suffix "W" to part number (example: L725W).

Types BYNA-RT15HT, BYNA-RTHT EHV
Compression Terminals for ACSS Conductor

Compression terminal for 250° C ACSS transmission lines at 345 kV and over.

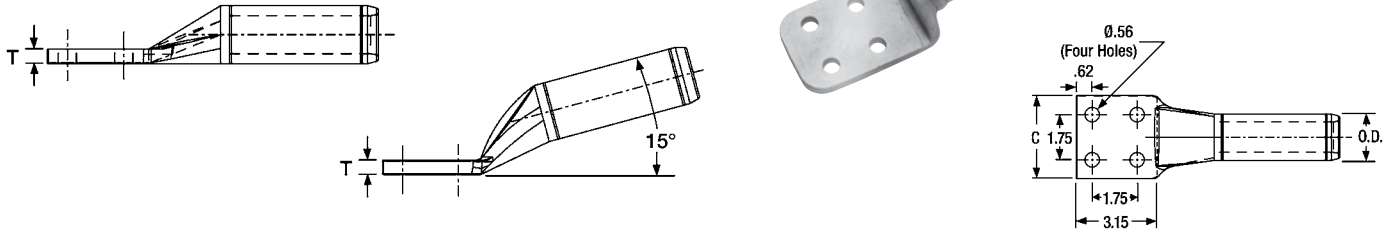

Conductor Name	ACSS		15° Terminal		Straight Terminal		Inches			Die*†	
	Size kcmil	Stranding		Catalog Number	Inches L	Catalog Number	Inches L	C	D		T
		Alum.	Steel								
Linnnet	336.4	26	7	BYNA32RT15HT	16.41	BYNA32RTHT	16.56	3.25	4.50	0.75	L717
Oriole	336.4	30	7	BYNA32RT15HT	16.41	BYNA32RTHT	16.56	3.25	4.50	0.75	L717
Ibis	397.5	26	7	BYNA34RT15HT	16.45	BYNA34RTHT	16.60	3.25	4.50	0.75	L719
Flicker	477	24	7	BYNA36RT15HT	16.76	BYNA36RTHT	16.92	3.25	4.50	0.75	L720
Hawk	477	26	7	BYNA36RT15HT	16.76	BYNA36RTHT	16.92	3.25	4.50	0.75	L720
Parakeet	556.5	24	7	BYNA39RT15HT	17.12	BYNA39RTHT	17.30	3.25	4.50	0.75	L722
Dove	556.5	26	7	BYNA39RT15HT	17.12	BYNA39RTHT	17.30	3.25	4.50	0.75	L722
Peacock	605	24	7	BYNA43RT15HT	14.41	BYNA43RTHT	15.46	3.07	3.95	0.36	L724
Squab	605	26	7	BYNA43RT15HT	14.41	BYNA43RTHT	15.46	3.07	3.95	0.36	L724
Rook	636	24	7	BYNA43RT15HT	14.41	BYNA43RTHT	15.46	3.07	3.95	0.36	L724
Grosbeak	636	26	7	BYNA43RT15HT	14.41	BYNA43RTHT	15.46	3.07	3.95	0.36	L724
Flamingo	666.6	24	7	BYNA43RT15HT	14.41	BYNA43RTHT	15.46	3.07	3.95	0.36	L724
Starling	715.5	26	7	BYNA451RT15HT	15.10	BYNA451RTHT	15.46	3.22	3.95	0.45	L725
Cuckoo	795	24	7	BYNA451RT15HT	15.10	BYNA451RTHT	15.46	3.22	3.95	0.45	L725
Drake	795	26	7	BYNA451RT15HT	15.10	BYNA451RTHT	15.46	3.22	3.95	0.45	L725
Tern	795	45	7	BYNA451RT15HT	15.10	BYNA451RTHT	15.46	3.22	3.95	0.45	L725
Condor	795	54	7	BYNA451RT15HT	15.10	BYNA451RTHT	15.46	3.22	3.95	0.45	L725
Ruddy	900	45	7	BYNA49RT15HT	15.14	BYNA49RTHT	15.66	3.22	3.95	0.52	L727
Rail	954	45	7	BYNA49RT15HT	15.14	BYNA49RTHT	15.66	3.22	3.95	0.52	L727
Cardinal	954	54	7	BYNA49RT15HT	15.14	BYNA49RTHT	15.66	3.22	3.95	0.52	L727
Ortolan	1033.5	45	7	BYNA49RT15HT	15.14	BYNA49RTHT	15.66	3.22	3.95	0.52	L727
Curlew	1033.5	54	7	BYNA49RT15HT	15.14	BYNA49RTHT	15.66	3.22	3.95	0.52	L727
Bluejay	1113	45	7	BYNA49RT15HT	15.14	BYNA49RTHT	15.66	3.22	3.95	0.52	L727
Finch	1113	54	19	BYNA52RT15HT	16.81	BYNA52RTHT	18.71	3.22	3.95	0.71	L728
Bunting	1192.5	45	7	BYNA52RT15HT	16.81	BYNA52RTHT	18.71	3.22	3.95	0.71	L728
Bittern	1272	45	7	BYNA52RT15HT	16.81	BYNA52RTHT	18.71	3.22	3.95	0.71	L728
Pheasant	1272	54	19	BYNA52RT15HT	16.81	BYNA52RTHT	18.71	3.22	3.95	0.71	L728
Dipper	1351.5	45	7	BYNA52RT15HT	16.81	BYNA52RTHT	18.71	3.22	3.95	0.71	L728
Martin	1351.5	54	19	BYNA52RT15HT	16.81	BYNA52RTHT	18.71	3.22	3.95	0.71	L728
Nuthatch	1510.5	45	7	BYNA56RT15HT	17.56	BYNA56RTHT	18.65	3.44	3.95	0.86	L729
Parrot	1510.5	54	19	BYNA56RT15HT	17.56	BYNA56RTHT	18.65	3.44	3.95	0.86	L729
Lapwing	1590	45	7	BYNA56RT15HT	17.56	BYNA56RTHT	18.65	3.44	3.95	0.86	L729
Falcon	1590	54	19	BYNA56RT15HT	17.56	BYNA56RTHT	18.65	3.44	3.95	0.86	L729
Chukar	1780	84	19	BYNA58RT15HT	18.28	BYNA58RTHT	18.59	3.47	3.95	0.80	L735
Bluebird	2156	84	19	BYNA59RT15HT	17.95	BYNA59RTHT	18.43	3.57	3.95	0.64	L735
Kiwi	2167	72	7	BYNA59RT15HT	17.95	BYNA59RTHT	18.43	3.57	3.95	0.64	L735

To specify hardware for bolting to corresponding dead-ends add the suffix "H" to the catalog number (example: BYNA52RHHT).

* Overlap crimps.

† Wide dies may be used on aluminum only (no steel), add suffix "W" to part number (example: L725W).

Type BYNS-RTHT EHV Jumper Loop Sleeve for ACSS Conductor

Jumper sleeve for 250° C ACSS transmission lines uat 345 kV and over. Sleeve is pre-filled with PENETROX™ joint compound and capped.



Conductor Name	Size kcmil	ACSS		Jumper Sleeve	Inches L	Die*‡
		Stranding				
		Alum.	Steel			
Linnet	336.4	26	7	BYNS32RTHT	18.84	L717
Oriole	336.4	30	7	BYNS32RTHT	18.84	L717
Ibis	397.5	26	7	BYNS34RTHT	18.98	L719
Flicker	477	24	7	BYNS36RTHT	19.52	L720
Hawk	477	26	7	BYNS36RTHT	19.52	L720
Parakeet	556.5	24	7	BYNS39RTHT	20.12	L722
Dove	556.5	26	7	BYNS39RTHT	20.12	L722
Peacock	605	24	7	BYNS43RTHT	20.24	L724
Squab	605	26	7	BYNS43RTHT	20.24	L724
Rook	636	24	7	BYNS43RTHT	20.24	L724
Grosbeak	636	26	7	BYNS43RTHT	20.24	L724
Flamingo	666.6	24	7	BYNS43RTHT	20.24	L724
Starling	715.5	26	7	BYNS451RTHT	20.36	L725
Cuckoo	795	24	7	BYNS451RTHT	20.36	L725
Drake	795	26	7	BYNS451RTHT	20.36	L725
Tern	795	45	7	BYNS451RTHT	20.36	L725
Condor	795	54	7	BYNS451RTHT	20.36	L725
Ruddy	900	45	7	BYNS49RTHT	20.42	L727
Rail	954	45	7	BYNS49RTHT	20.42	L727
Cardinal	954	54	7	BYNS49RTHT	20.42	L727
Ortolan	1033.5	45	7	BYNS49RTHT	20.42	L727
Curlew	1033.5	54	7	BYNS49RTHT	20.42	L727
Bluejay	1113	45	7	BYNS49RTHT	20.42	L727
Finch	1113	54	19	BYNS52RTHT	25.96	L728
Bunting	1192.5	45	7	BYNS52RTHT	25.96	L728
Bittern	1272	45	7	BYNS52RTHT	25.96	L728
Pheasant	1272	54	19	BYNS52RTHT	25.96	L728
Dipper	1351.5	45	7	BYNS52RTHT	25.96	L728
Martin	1351.5	54	19	BYNS52RTHT	25.96	L728
Nuthatch	1510.5	45	7	BYNS56RTHT	25.34	L729
Parrot	1510.5	54	19	BYNS56RTHT	25.34	L729
Lapwing	1590	45	7	BYNS56RTHT	25.34	L729
Falcon	1590	54	19	BYNS56RTHT	25.34	L729
Chukar	1780	84	19	BYNS58RTHT	25.22	L735
Bluebird	2156	84	19	BYNS59RTHT	24.9	L735
Kiwi	2167	72	7	BYNS59RTHT	24.9	L735



* Overlap crimps.

‡ Wide dies may be used on aluminum only (no steel), add suffix "W" to part number (example: L725W).

NOTE: Remove "T" from middle of part number for non-EHV <230kV version. (Example: BYNS58RHT)

Type YTS-AT EHV

Full Tension Splice for AAC/ACAR

Full tension splice for Stranded Aluminum Transmission line at 345 kV and over. Manufactured of aluminum tube with staked-in cable stop. Prefilled with PENETROX™ joint compound and capped.

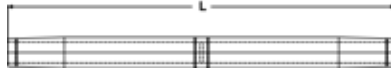

Catalog Number	Conductor			Inches L	Tool, Die Sets			
	Conductor Name	Aluminum			Die Index	Y45*	46* Series	Y60LW* †
		kcmil	Strands					
YTS301AT	Tulip	336.4	19	9.75	717	S725	P725	L717
YTS301AT		350	37			S725	P725	
YTS311AT	Canna	397.5	19	9.99	719	S719	P719	L719
YTS311AT		400	37			S719	P719	
YTS331AT	Cosmos	450	37	10.01	719	S719	P719	
YTS331AT		477	19			S719	P719	
YTS331AT	Syringa	477	37			S719	P719	
YTS351AT	Hyacinth	500	37	11.88	720	S720	P720	L720
YTS351AT	Dahlia	556.5	19			S720	P720	
YTS351AT	Mistletoe	556.5	37			S720	P720	
YTS361AT	Orchid	600	61	12.92	722	S722	P722	L722
YTS361AT		636	37			S722	P722	
YTS39AT	Violet	715.5	37	14.36	724	S724	P724	L724
YTS39AT	Nasturtium	715.5	61			S724	P724	
YTS39AT	Cattail	750	61			S724	P724	
YTS391AT	Arbutus	795	37	16.36	724	S724	P724	
YTS391AT	Lilac	795	61			S724	P724	
YTS391AT		800	61			S724	P724	
YTS431AT	Anemone	874.5	37	17.92	725	S725	P725	L725
YTS431AT	Crocus	874.5	61			S725	P725	
YTS431AT	Magnolia	954	37			S725	P725	
YTS431AT	Goldenrod	954	61			S725	P725	
YTS445AT	Bluebell	1033.5	37	19.57	727	—	—	L727
YTS445AT	Larkspur	1033.5	61			—	—	
YTS445AT	Marigold	1113	37			—	—	
YTS445AT		1113	61			—	—	
YTS451AT	Hawthorn	1192.6	61	19.24	728	—	—	L728
YTS451AT	Nacrcissus	1272	61			—	—	
YTS457AT	Columbine	1351.5	61	21.08	728	—	—	L728
YTS457AT	Carnation	1431	61			—	—	
YTS463AT	Coreopsis	1590	61	22.56		—	—	
YTS47AT	Jessamine	1750	61	21.08	728	—	—	L728
YTS48AT		2000	169	23.02	735	—	—	L735
YTS484AT		2300	61	23.00		—	—	
YTS486AT	Lupine	2500	91	24.28	740	—	—	L740

* Overlap Crimp.

† Wide dies may be used on aluminum only, add suffix "W" to part number (example: L725W).

Types YNA-R15, YNA-R

Compression Terminal for ACAR, Stranded Aluminum Cable

Compression terminal for ACAR and Stranded Aluminum Cable. Two hole NEMA tongue supplied through 650 kcmil Aluminum for transmission line up to and including 230 kV. Four hole NEMA supplied on sizes above 650 kcmil. When used with YTW Deadends, the 15° angle tongue provides either a 0° or 30° tap. Uses same dies as equivalent full tension sleeve or deadend. Barrel pre-filled with PENETROX™ joint compound and capped. Pad coated with oxide retardant.

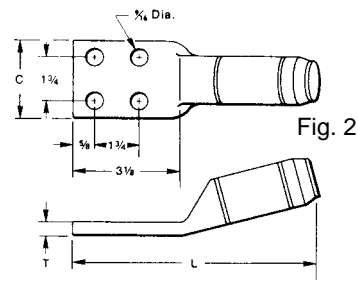
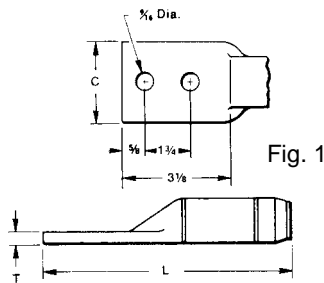

Catalog Number †		Conductor		Fig. #	C	L 15°	L Straight	T	Tools, Die Sets			
									Die Index	Y45*	46* Series	Y60LW*‡
15°	Straight	ACAR	Aluminum	1	1.68"	8.92"	8.96"	0.39"	717	S717	P717	L717
YNA32R15	YNA32R	395.1 - 395.2	336.4 - 350		1.78"	9.31"	9.08"	0.46"	719	S719	P719	L719
YNA34R15	YNA34R	—	397.5 - 477		1.96"	9.62"	9.47"	0.48"	720	S720	P720	L720
YNA36R15	YNA36R	—	500 - 556.5		2.08"	10.09"	9.84"	0.53"	722	S722	P722	L722
YNA39R15	YNA39R	634.9 - 653.1	600 - 650	2	3.07"	10.16"	10.07"	0.36"	724	S724	P724	L724
YNA43R15	YNA43R	—	700 - 800		3.22"	10.21"	10.28"	0.45"	725	S725	P725	L725
YNA451R15	YNA451R	840.2 - 927.2	795 - 1000			10.35"	10.46"	0.52"	727			L727
YNA49R15	YNA49R	983.1 - 1198	1033.5 - 1272			12.09"	12.24"	0.71"	728			L728
YNA52R15	YNA52R	1277 - 1280	1351.5 - 1510	1	13.30"	13.46"	0.71"	728			L728	
YNA54R15	YNA54R	1534	1590 - 1600		3.44"	12.50"	12.74"	0.86"	729	—	—	L729
YNA56R15	YNA56R	1650 (42/19 STR)	1700 - 1800	2	3.47"	13.25"	13.34"	0.76"	735			L735
YNA58R15	YNA58R	—	2000	1	3.57"	13.12"	13.25"	0.61"	735			L735
YNA59R15	YNA59R	—	2250 - 2300		3.70"	12.81"	14.35"	0.68"	740			L740
YNA594R15	YNA594R	2267 - 2500	2500									

† To specify mounting hardware for bolting to corresponding deadend pad, add suffix "H" to catalog number (example: YNA54RTH)

* Overlap Crimp.

‡ Wide dies may be used on aluminum only, add suffix "W" to part number (example: L725W).

Types YNA-RT15, YNA-RT EHV

Compression Terminal for EHV ACAR, Stranded Aluminum Cable

Compression terminal for ACAR and Stranded Aluminum Cable. Two hole NEMA tongue supplied through 650 kcmil Aluminum for transmission line at 345 kV and above. Four hole NEMA supplied on sizes above 650 kcmil. When used with YTW Deadends, the 15° angle tongue provides either a 0° or 30° tap. Uses same dies as equivalent full tension sleeve or deadend. Barrel pre-filled with PENETROX™ joint compound and capped. Pad coated with oxide retardant.

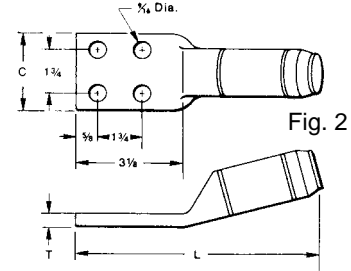
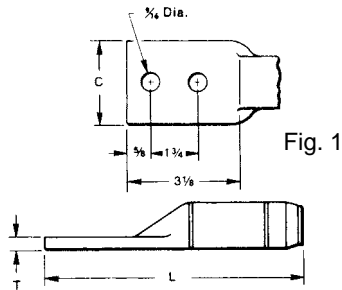

Catalog Number †		Conductor		Fig. No.	C	L 15°	L Straight	T	T 15	Tools, Die Sets				
15°	Straight	ACAR	Aluminum							Die Index	Y45*	46* Series	Y60LW*‡	
YNA32RT15	YNA32RT	395.1 - 395.2	336.4 - 350	1	1.68"	9.04"	9.14"	0.39"	0.39"	717	S717	P717	L717	
YNA34RT15	YNA34RT	—	397.5 - 477		1.78"	9.21"	9.30"	0.46"	0.46"	719	S719	P719	L719	
YNA36RT15	YNA36RT	—	500 - 556.5		1.96"	9.63"	9.70"	0.48"	0.48"	720	S720	P720	L720	
YNA39RT15	YNA39RT	650 (37)	600 - 650		2.08"	10.02"	10.09"	0.53"	0.53"	722	S722	P722	L722	
YNA43RT15	YNA43RT	—	700 - 800	2	3.22"	10.21"	10.32"	0.36"	0.36"	724	S724	P724	L724	
YNA451RT15 ‡‡	YNA451RT ‡‡	850 (37) 900 (37)	795 - 1000			10.65"	10.57"	0.45"	0.45"	725	S725	P725	L725	
YNA49RT15 ‡‡	YNA49RT ‡‡	1000 (61) 1100 (61)	1033.5 - 1272			10.94"	10.77"	0.52"	0.52"	727	—	—	L727	
YNA52RT15 ‡‡	YNA52RT ‡‡	4 (7)	1351.5 - 1510			12.62"	13.82"	0.71"	0.71"	728	—	—	L728	
YNA54RT15 ‡‡	YNA54RT ‡‡	1534	1590 - 1600			—	—	0.71"	0.71"	728	—	—	L728	
YNA56RT15 ‡‡	YNA56RT ‡‡	1650 (42/19 STR)	1700 - 1800			3.44"	13.36"	13.76"	0.86"	0.86"	729	—	—	L729
YNA58RT15 ‡‡	YNA58RT ‡‡	—	2000			3.47"	14.08"	13.70"	0.80"	0.80"	735	—	—	L735
YNA59RT15 ‡‡	YNA59RT ‡‡	—	2250 - 2300			3.57"	13.75"	13.54"	0.64"	0.64"	735	—	—	L735
YNA594RT15 ‡‡	YNA594RT ‡‡	2267 - 2500	2500			3.70"	—	—	0.68"	0.68"	740	—	—	L740

† To specify mounting hardware for bolting to corresponding deadend pad, add suffix "H" to catalog number (example: YNA54RTH)

* Overlap crimps

‡ Wide dies may be used, add suffix "W" to part number (example: L725W)

‡‡ If shielding caps are required for this item, use Catalog Number STS43A-4N

Type YNS-RT EHV

Jumper Loop Sleeve for EHV ACAR, Stranded Aluminum Cable

Jumper sleeve for ACAR and Stranded Aluminum Cable. over 230 kV. Sleeve prefilled with PENETROX™ joint compound and capped.

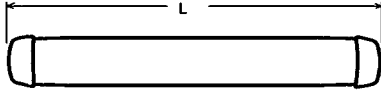

Catalog Number	Conductor (Kcmil)		Inches L	Tools, Die Sets			
	ACAR	Aluminum		Die Index	Y45*	46* Series	Y60LW*‡
YNS32RT	395.1 - 395.2	336.4 - 350	8.96	717	S717	P717	L717
YNS34RT	-	397.5 - 477	9.10	719	S719	P719	L719
YNS36RT	-	500 - 556.5	9.64	720	S720	P720	L720
YNS39RT	634.9 - 653.1	600 - 650	10.26	722	S722	P722	L722
YNS43RT	-	700 - 800	10.48	724	S724	P724	L724
YNS451RT	840.2 - 927.2	795 - 1000	10.60	725	S725	P725	L725
YNS49RT	983.1 - 1198	1033.5 - 1272	10.66	727	—	—	L727
YNS52RT	1277 - 1280	1351.5 - 1510	16.20	728	—	—	L728
YNS54RT	1534	1590 - 1600	16.11	728	—	—	L728
YNS56RT	1650 (42-19 STR)	1700 - 1800	15.58	729	—	—	L729
YNS58RT	-	2000	15.46	735	—	—	L735
YNS59RT	-	2250 - 2300	15.14	735	—	—	L735
YNS594RT	2267 - 2500	2500	16.53	740	—	—	L740

* Overlap crimps

‡ Wide dies may be used, add suffix "W" to part number (example: L725W).

NOTE: Remove "T" suffix for non-EHV <230kV version. (Example: YNS39R)

Type YNA-M-T

Terminal for Alumoweld, EHS Steel

Compression terminal for joining Alumoweld and EHS Steel to Types YTW-M-T and YTW-E deadends. Installed with same dies as equivalent full tension splice and deadend. Barrel is prefilled with PENETROX™ joint compound and capped.

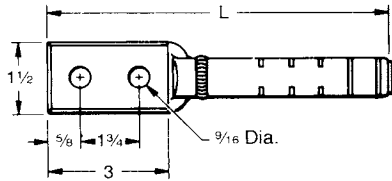

Catalog Number	Conductor		L (IN)	Die Index	Tools Dies and Sets (Number of Crimps)	
	Alumoweld	EHS Steel			35, 750, 45†, 46‡‡ Series	Y60LW*
YNA7M10T	7 #10, 3 #7	5/16" 7 str.	8.50	676 or 721	U676 (4)	L721
YNA7M8T	7 #8, 3 #5	3/8" 7 str.	9.81	668 or 723	U668 (7)	L723
YNA7M7T	7 #7, 3 #5	7/16" 7 str.	9.95	678 or 726	U678 (10)	L726
YNA7M6T	7 #6	1/2" 7 str.	9.80	679 or 726	U679 (11)	L789

* Overlap crimps.

† U Die with adapter PT6515.

‡‡ U Die with adapter PUADP1.

Type YDS-M-T

Full Tension Sleeve for Alumoweld

Full tension splice for Alumoweld transmission lines. Five connectors accommodate eight conductor sizes. Sleeve is prefilled with PENETROX™ joint compound and capped.



RUS Accepted

Catalog Number †††	Conductor	L (in)	Tools Dies and Sets (Number of Crimps)		
	Alumoweld		Die Index	Y35	Y60LW*
YDS7M10T	7 #10, 3 #7	9.91	676 or	U676 (8)	—
			721	—	L721
YDS7M9T	7 #9, 3 #6	10.41	677	U677 (10)	—
YDS7M8T	7 #8, 3 #5	12.21	668 or	U668 (13)	—
			723	—	L723
YDS7M7T	7 #7	14.56	678 or	U678 (19)	—
			726	—	L726
YDS7M6T	7 #6	15.17	679 or	U679 (2)	—
			726	—	L726

* Overlap crimps.

††† Sleeve is high strength aluminum alloy for optimum corrosion resistance.

Type YTS-E

Full Tension Splice for EHS Steel, Messenger, "Static" Cable

Full tension splice for EHS Steel Guy, Messenger, or "Static" Cable. Sleeve is prefilled with PENETROX™ joint compound and capped.

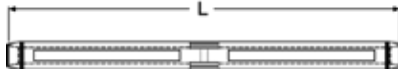

Catalog Number †	Accommodates EHS Steel	L (in)	Tools, Die Sets	
			Die Index	Y60LW*
YTS312E	5/16" 7 Str	11.30	721	L721
YTS375E	3/8" 7 Str.	10.38	723	L723
YTS438E	7/16" 7 Str.	11.78	726	L726
YTS500E	1/2" 7 Str	16.63	789	L789

* Overlap crimps.

† Sleeve is high strength aluminum alloy for optimum corrosion resistance.

Full Tension Deadend Kits

For ACCC® Conductor; Single / Double Pads available

Full tension deadends for ACCC® transmission lines up to and including 230 kV. Standard 15° NEMA tap pad provides either 0° or 30° tap when Type BYNA-RT15HACCC terminal is used.

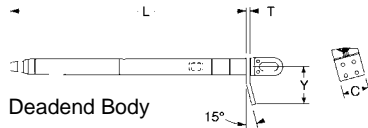
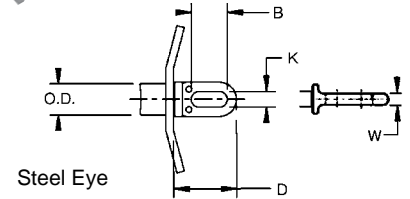
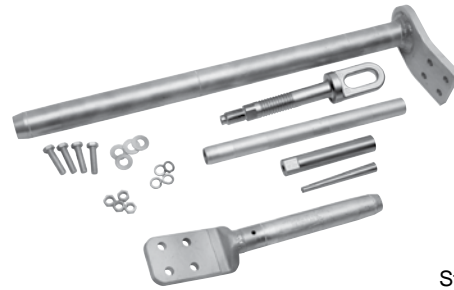

ACCC® Conductor Name	Size kcmil	Single Pad Deadend Kit Including Composite Core Grip Components (See Note 2 for Double Pad)	15 Degree Terminal with Aluminum Hardware Included in Kit	Installation Tooling Using 60 Ton Y60LW	
				Die* Deadend	Die* Terminal
Helsinki	297	YTW160MRE15ACK6	BYNA106MM2T15HACCC	L727W	L725W
Pasadena	297				
Jaipur	307	YTW165MRE15ACK6	BYNA32RT15HACCC	L727W	L717W
Zadar	350	YTW320RE15ACCCK4			
Linnet	430	YTW32RE15ACCCK4			
Copenhagen	434	YTW320RE15ACCC4			
Oriole	439	YTW320RE15ACCC4	BYNA235MMT15HACCC	L735W	L720W
Reykjavik	440	YTW235MRE15ACK5			
Monte Carlo	451	YTW245MRE15ACK6	BYNA245MM2T15HACCC	L727W	L725W
Waco	454	YTW245MRE15ACK6			
Glasgow	467	YTW36RE15ACCCK4	BYNA36RT15HACCC	L727W	L720W
Laredo	530				
Casablanca	540	YTW330MRE15ACK6	BYNA39RT15HACCC	L735W	L722W
Irving	609				
Hawk	611	YTW36RE15ACCCK4	BYNA36RT15HACCC	L727W	L720W
Oslo	619	YTW330MRE15ACK6			
Lisbon	623	YTW36RE15ACCCK4	BYNA39RT15HACCC	L735W	L722W
Dove	714	YTW36RE15ACCCK4			
Amsterdam	725	YTW39RE15ACCCK4	BYNA39RT15HACCC	L727W	L722W
Grosbeak	821	YTW43RE15ACCCK4			
Brussels	832	YTW43RE15ACCCK4	BYNA43RT15HACCC	L727W	L724W
Stockholm 3L	895	YTW470MRE15ACK5			
Lubbock	904	YTW470MRE15ACK5	BYNA451RT15HACCC	L735W	L725W
Stockholm 2L	914				
Warsaw	1002	YTW530MRE15ACK5			
Galveston	1011	YTW451RE15ACCCK4			
Drake	1026				
Dublin	1035				

Notes:
ACCC is a Registered Trade Mark of CTC Cable Corp.

* Overlap Crimps

- Other styles may be available. Please contact customer service for products or conductor sizes not shown.
- Dual (2) Pad Deadend catalog numbers have "D" in the middle after "E". Example for Drake Dual Pad Kit = YTW451RED15ACCCK4

- Deadend Kit Contains: Aluminum Body, Steel Eye, Terminal with Hardware, and Composite Core Grip Components
- Designed for corona free operation up to 230 kV without accessories. Contact factory for 345 kV and 500 kV operation.
- For stainless steel hardware, contact customer service.
- Dimensions in brackets [] denote metric units and are rounded to nearest whole number.

Full Tension ACCC® Deadend Kits
(Continued)

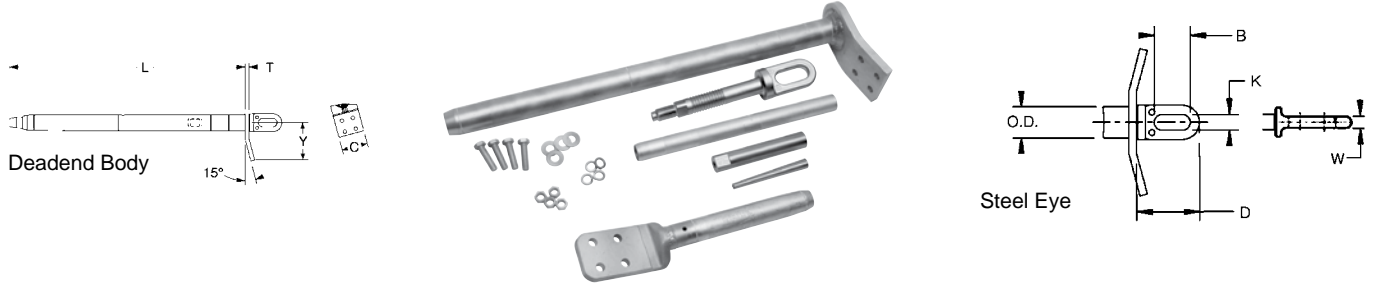

ACCC® Conductor Name	Size kcmil	Single Pad Deadend Kit Including Composite Core Grip Components (See Note 2 for Double Pad)	15 Degree Terminal with Aluminum Hardware Included in Kit	Installation Tooling	
				Using 60 Ton Y60LW	
				Die* Deadend	Die* Terminal
Plano	1059	YTW570MRE15ACK5	BYNA590MRT15HACCC	L727W	
Mahakam	1075	YTW545MRE15ACK5			
Hamburg	1078	YTW570MRE15ACK5			
Corpus Christi	1103	YTW590MRE15ACK5			
Milan	1120				
Arlington	1151	YTW610MRE15ACK5			
Rome	1169				
Cardinal	1222	YTW48RE15ACCCK4	BYNA49RT15HACCC	L735W	
Vienna	1242				
Fort Worth	1300	YTW690MRE15ACK5			
Budapest	1319				
El Paso	1350	YTW710MRE15ACK5			
Prague	1363		BYNA760MRT15HACCC	L728W	
Beaumont	1429	YTW760MRE15ACK5			
Munich	1447				
San Antonio	1475	YTW780MRE15ACK5			
London	1498		BYNA52RT15HACCC		
Bittern	1582	YTW52RE15ACCCK4			
Paris	1606				
Lapwing	1949	YTW549RE15ACCCK4	BYNA56RT15HACCC	L735W	L735W
Madrid	1999				
Falcon	2045	YTW56RE15ACCCK4	BYNA56RT15HACCC	L735W	L735W
Bluebird	2741				
Athens	2782	YTW59RE15ACCCK4	BYNA59RT15HACCC	L729W	L729W

Notes:
ACCC is a Registered Trade Mark of CTC Cable Corp.

* Overlap Crimps

- Other styles may be available. Please contact customer service for products or conductor sizes not shown.
- Dual (2) Pad Deadend catalog numbers have "D" in the middle after "E". Example for Drake Dual Pad Kit = YTW451RED15ACCCK4

- Deadend Kit Contains: Aluminum Body, Steel Eye, Terminal with Hardware, and Composite Core Grip Components
- Designed for corona free operation up to 230 kV without accessories. Contact factory for 345 kV and 500 kV operation.
- For stainless steel hardware, contact customer service.
- Dimensions in brackets [] denote metric units and are rounded to nearest whole number.

Full Tension Splice Kits For ACCC® Conductor

Two-piece, full tension splices for ACCC® transmission lines up to and including 230 kV.

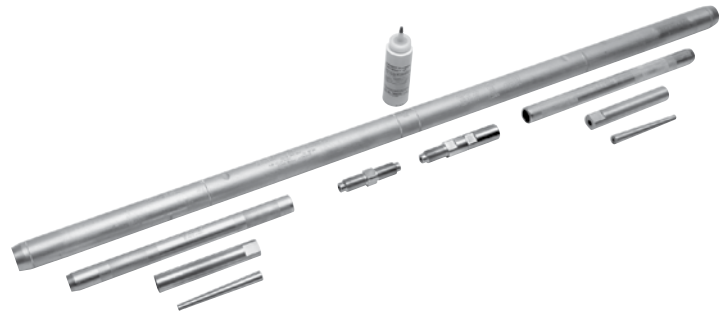
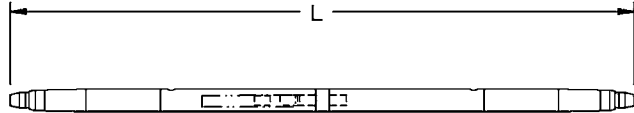

Conductor Name	Size kcmil	Catalog Number	Die*	
			Using Y60LW tool	
Helsinki	297	YTS160MRTAC5	L727W	
Pasadena	297			
Jaipur	307	YTS165MRTAC5		
Zadar	350	YTS320RTACCC2		
Linnet	430	YTS32RTACCC2		
Copenhagen	434			
Oriole	439	YTS320RTACCC2		
Reykjavik	440			
Monte Carlo	451	YTS235MRTAC5		
Waco	454	YTS245MRTAC5		
Glasgow	467			
Laredo	530	YTS36RTACCC2		
Casablanca	540			
Irving	609	YTS330MRTAC5		L735W
Hawk	611	YTS36RTACCC2		L727W
Oslo	619	YTS330MRTAC5	L735W	
Lisbon	623	YTS36RTACCC2	L727W	
Dove	714	YTS39RTACCC2		
Amsterdam	725			
Grosbeak	821	YTS43RTACCC2		
Brussels	832			
Stockholm 3L	895	YTS470MRTAC5	L735W	
Lubbock	904			
Stockholm 2L	914			
Warsaw	1002	YTS530MRTAC5		
Galveston	1011			

Conductor Name	Size kcmil	Catalog Number	Die*
			Using Y60LW tool
Drake	1026	YTS451RTACCC2	L735W
Dublin	1035		
Plano	1059	YTS570MRTAC5	
Mahakam	1075	YTS545MRTAC5	
Hamburg	1078	YTS570MRTAC5	
Corpus Christi	1103		
Milan	1120		
Arlington	1151	YTS610MRTAC5	
Rome	1169		
Cardinal	1222	YTS48RTACCC2	
Vienna	1242		
Fort Worth	1300	YTS690MRTAC5	
Budapest	1319		
El Paso	1350	YTS710MRTAC5	
Prague	1363		
Beaumont	1429	YTS760MRTAC5	
Munich	1447		
San Antonio	1475	YTS780MRTAC5	
London	1498		
Bittern	1582	YTS52RTACCC2	
Paris	1606		
Lapwing	1949	YTS549RTACCC2	L735W
Madrid	1999		
Falcon	2045	YTS56RTACCC2	L735W
Bluebird	2741	YTS59RTACCC2	L735W
Athens	2782		

Notes:
ACCC is a Registered Trade Mark of CTC Cable Corp.

* Overlap Crimps

- Other styles may be available. Please contact customer service for products or conductor sizes not shown.
- Splice Kit Contains: Aluminum Body and Composite Core Grip Components
- Designed for corona free operation up to 230 kV without accessories. Contact factory for 345 kV and 500 kV operation.
- Dimensions in brackets [] denote metric units and are rounded to nearest whole number.

Types BYNA-RTACCC, BYNA-RT15ACCC
Terminals for ACCC®, Straight and 15 Degree

Compression terminal for ACCC® transmission lines up to and including 230 kV.

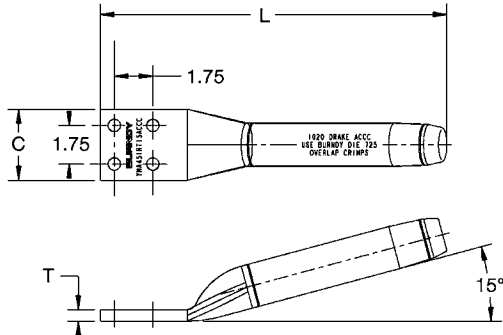

Conductor Name	Size kcmil	15 Degree Terminal Catalog Number with AL Hardware	Straight Terminal Catalog Number with AL Hardware	Installation Tooling			
				Die Index	Y45*	46 Series*	Y60LW*
Helsinki	297	BYNA160MM2T15HACCC	BYNA160MM2THACCC	725	S725	P725	L725W
Pasadena	297						
Jaipur	307						
Zadar	350	BYNA32RT15HACCC	BYNA32RTHACCC	717	S717	P717	L717W
Linnet	430						
Copenhagen	434						
Oriole	439						
Reykjavik	440						
Monte Carlo	451	BYNA235MMT15HACCC	BYNA235MMTHACCC	720	S720	P720	L720W
Waco	454	BYNA245MM2T15HACCC	BYNA245MM2THACCC	725	S725	P725	L725W
Glasgow	467						
Laredo	530	BYNA36RT15HACCC	BYNA36RTHACCC	720	S720	P720	L720W
Casablanca	540	BYNA39RT15HACCC	BYNA39RTHACCC	722	S722	P722	L722W
Irving	609						
Hawk	611						
Oslo	619						
Lisbon	623						
Dove	714						
Amsterdam	725						
Grosbeak	821	BYNA43RT15HACCC	BYNA43RTHACCC	724	S724	P724	L724W
Brussels	832						

Notes:
ACCC is a Registered Trade Mark of CTC Cable Corp.

* Overlap Crimps

- Other styles may be available. Please contact customer service for products or conductor sizes not shown.
- Designed for corona free operation up to 230 kV without accessories. Contact factory for 345 kV and 500 kV operation.
- For stainless steel hardware, contact customer service.
- Dimensions in brackets [] denote metric units and are rounded to nearest whole number.

Compression Terminals for ACCC® (Continued)



Conductor Name	Size kcmil	15 Degree Terminal Catalog Number with AL Hardware	Straight Terminal Catalog Number with AL Hardware	Installation Tooling			
				Die Index	Y45*	46 Series*	Y60LW*
Stockholm 3L	895	BYNA451RT15HACCC	BYNA451RTHACCC	725	S725	P725	L725W
Lubbock	904						
Stockholm 2L	914						
Warsaw	1002						
Galveston	1011						
Drake	1026						
Dublin	1035						
Plano	1059	BYNA590MRT15HACCC	BYNA590MRTHACCC	727	—	—	L727W
Mahakam	1075						
Hamburg	1078						
Corpus Christi	1103						
Milan	1120						
Arlington	1151						
Rome	1169						
Cardinal	1222	BYNA49RT15HACCC	BYNA49RTHACCC	727	—	—	L727W
Vienna	1242						
Fort Worth	1300						
Budapest	1319						
El Paso	1350						
Prague	1363	BYNA760MRT15HACCC	BYNA760MRTHACCC	728	—	—	L728W
Beaumont	1429						
Munich	1447	BYNA52RT15HACCC	BYNA52RTHACCC	728	—	—	L728W
San Antonio	1475						
London	1498						
Bittern	1582						
Paris	1606	BYNA56RT15HACCC	BYNA56RTHACCC	735	—	—	L735W
Lapwing	1949						
Madrid	1999	BYNA56RT15HACCC	BYNA56RTHACCC	735	—	—	L735W
Falcon	2045						
Bluebird	2741	BYNA59RT15HACCC	BYNA59RTHACCC	729	—	—	L729W
Athens	2782						

Notes:
ACCC is a Registered Trade Mark of CTC Cable Corp.

* Overlap Crimps

- Other styles may be available. Please contact customer service for products or conductor sizes not shown.
- Designed for corona free operation up to 230 kV without accessories. Contact factory for 345 kV and 500 kV operation.
- For stainless steel hardware, contact customer service.
- Dimensions in brackets [] denote metric units and are rounded to nearest whole number.

Type YNTA-RTACCC

T-Tap Connector with Pad for ACCC®

Two-piece compression T-Tap connector to a NEMA pad for ACCC® transmission lines up to and including 230 kV.

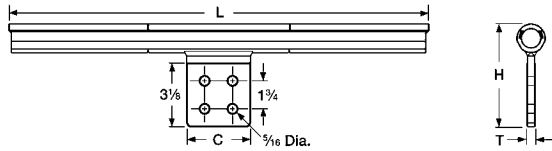

Conductor Name	Size kcmil	Catalog Number	Dimensions (Inches)				Installation Tooling			
			L	C	H	T	Die Index	Y45*	46* Series	Y60LW*
Waco	454	YNTA245MRTACCC	25.50 [648]	4.00	5.93 [150]	0.56 [14]	719	S719	P719	L719W
Glasgow	467				6.03 [153]					
Laredo	530	YNTA36RTACCC	25.50 [648]	4.00	6.03 [153]	0.56 [14]	720	S720	P720	L720W
Casablanca	540				6.13 [156]					
Hawk	611				6.24 [158]					
Lisbon	623	YNTA39RTACCC	26.06 [662]	4.00	6.13 [156]	0.56 [14]	722	S722	P722	L722W
Oslo	619				6.24 [158]					
Dove	714	YNTA43RTACCC	26.28 [667]	4.00	6.24 [158]	0.56 [14]	724	S724	P724	L724W
Amsterdam	725				6.43 [163]					
Grosbeak	821	YNTA451RTACCC	26.38 [670]	4.00	6.43 [163]	0.56 [14]	725	S725	P725	L725W
Brussels	832				6.60 [168]					
Stockholm 3L	895				6.60 [168]					
Lubbock	904				6.60 [168]					
Stockholm 2L	914				6.60 [168]					
Warsaw	1002				6.60 [168]					
Galveston	1011				6.60 [168]					
Drake	1026				6.60 [168]					
Dublin	1035	YNTA49RTACCC	26.36 [669]	4.00	6.60 [168]	0.56 [14]	727	—	—	L727W
Mahakam	1075				6.60 [168]					
Hamburg	1078				6.60 [168]					
Milan	1120				6.60 [168]					
Arlington	1151				6.60 [168]					
Rome	1169				6.60 [168]					
Cardinal	1222				6.60 [168]					
Vienna	1242				6.60 [168]					
Fort Worth	1300				6.60 [168]					
Budapest	1319				6.60 [168]					
El Paso	1350	YNTA52RTACCC	29.32 [745]	4.00	7.00 [178]	0.69 [17]	728	—	—	L728W
Prague	1363				7.00 [178]					
Beaumont	1429				7.00 [178]					
Munich	1447				7.00 [178]					
San Antonio	1475				7.00 [178]					
London	1498				7.00 [178]					
Bittern	1582	7.00 [178]								
Paris	1606	7.00 [178]								

Notes:
ACCC is a Registered Trade Mark of CTC Cable Corp.

* Overlap Crimps

1. Other styles may be available. Please contact customer service for products or conductor sizes not shown.
2. Designed for corona free operation up to 230 kV without accessories. Contact factory for 345 kV and 500 kV operation.
3. Dimensions in brackets [] denote metric units and are rounded to nearest whole number.

Type YNU-RACCC Compression Repair Sleeve for ACCC®

Two-piece compression repair sleeves for temporary restoration of conductivity to damaged ACCC® transmission lines.

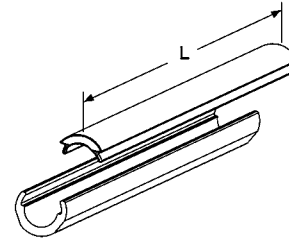

Conductor Name	Size kcmil	Catalog Number	Installation Tooling			
			Die Index	Y45*	Y46*	Y60BHU*
Glasgow	473	YNU245MRACCC	719	S719	P719	L719W
Casablanca	546	YNU36RACCC	720	S720	P720	L720W
Hawk	611					
Lisbon	629					
Oslo	627	YNU39RACCC	722	S722	P722	L722W
Dove	713					
Amsterdam	733					
Grosbeak	816	YNU43RACCC	724	S724	P724	L724W
Brussels	839					
Stockholm	913	YNU451RACCC	725	S725	P725	L725W
Warsaw	1016					
Drake	1020					
Dublin	1043					
Hamburg	1092	YNU49RACCC	727	—	—	L727W
Milan	1134					
Rome	1183					
Cardinal	1222					
Vienna	1255					
Budapest	1332					
Prague	1377					
Munich	1461	YNU52RACCC	728	—	—	L728W
London	1512					
Bittern	1572					
Paris	1620					

ACCC is a Registered Trade Mark of CTC Cable Corp.

Dimensions in brackets [] denotes metric units and are rounded to nearest whole number.

* Overlap crimps.

Type STS-A-NCG, Single Piece
Terminal Pad Cap; EHV

Bolted 1-piece terminal pad cap of cast Aluminum; Stainless Steel Hardware.

Material: Cast 356 Aluminum Alloy

EHV Rated: Self Shielding up to 550 kV

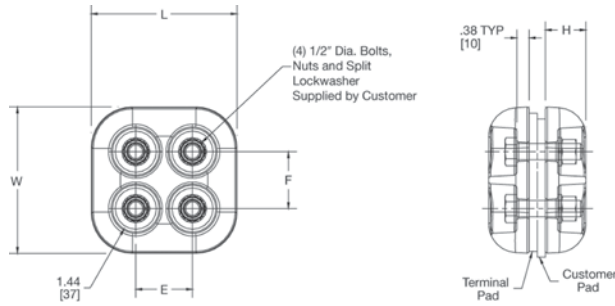
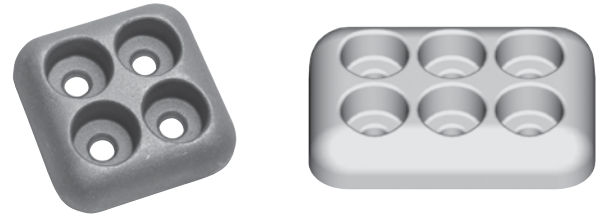

Catalog Number	E	F	H	L	W	Maximum Shielded Area
STS44ACG10	1.75 [44]	1.75 [44]	1.50 [38]	4.00 [102]	4.00 [102]	3.5 x 3.5
STS44A4NCG2	1.75 [44]	1.75 [44]	1.25 [32]	4.50 [114]	4.50 [114]	4 x 4
STS46A6NCG1	1.75 [44]	1.75 [44]	1.25 [32]	4.50 [114]	6.50 [165]	6 x 4

NOTES:

1. Dimensions in brackets [] are in millimeters.
2. Catalog number is for one shielding cap only. If more than one is required, specify total quantity.

Type S2GPB-A (Spacer); Type S2GBPA-A (Terminal Tap); Type SH2GBP-A (Bus Support) Bolted Bundled Cable Spacers

Bolted Cable-to-Cable Spacer (Two Cables), cable spacer with four hole pad, and cable spacer to insulator.

Material: Cast 356 Aluminum Alloy
Hardware: Aluminum Alloy

EHV Rated: Self Shielding up to 550 kV



Fig. 1

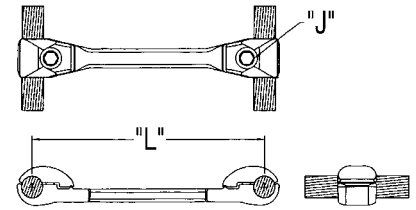

Fig. 1

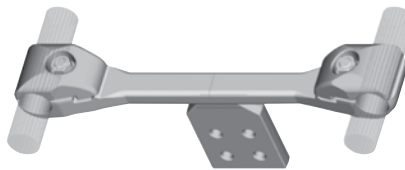

Fig. 2

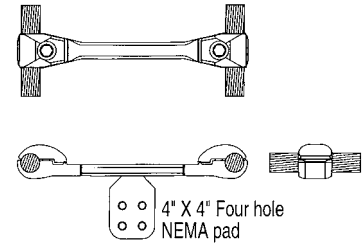

Fig. 2

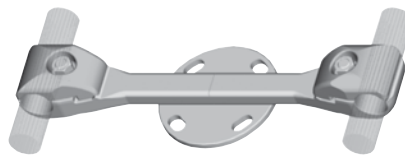

Fig. 3

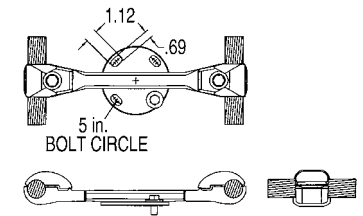

Fig. 3

Catalog Number			Cable Range		Cable Dia.		"L"	"J" Dia.
Fig. 1	Fig. 2	Fig. 3	AAC	ACSR	Min.	Max.		
S2GBP41A	S2GBPA41A	SH2GBP41A5	795 kcmil 37 Str. (1.026 Dia.)	715 kcmil 24/7 Str. (1.036 Dia.)	1.026 [26]	1.092 [28]	18.00 [457]	5/8"-11 X 1-3/4" LG. Alum. Alloy
S2GBP41A12	S2GBPA41A12	SH2GBP41A512	874.5 kcmil 61 Str. (1.077 Dia.)	715.5 kcmil 26/7 Str. (1.051 Dia.)			12.00 [305]	
S2GBP44A	S2GBPA44A	SH2GBP44A5	954 kcmil 61 Str. (1.126 Dia.)	795 kcmil 24/7 Str. (1.092 Dia.)	1.092 [28]	1.165 [30]	18.00 [457]	5/8"-11 X 2" LG. Alum. Alloy
S2GBP44A12	S2GBPA44A12	SH2GBP44A512		795 kcmil 54/7 Str. (1.093 Dia.)			12.00 [305]	
S2GBP445A	S2GBPA445A	SH2GBP445A5	1033.5 kcmil 37 Str. (1.170 Dia.)	954 kcmil 45/7 Str. (1.165 Dia.)	1.165 [30]	1.246 [32]	18.00 [457]	
S2GBP445A12	S2GBPA445A12	SH2GBP445A512		1033.5 kcmil 45/7 Str. (1.213 Dia.)			12.00 [305]	
S2GBP45A	S2GBPA45A	SH2GBP45A5	1192 kcmil 61 Str. (1.258 Dia.)	1033.5 kcmil 54/7 Str. (1.246 Dia.)	1.246 [32]	1.382 [35]	18.00 [457]	
S2GBP45A12	S2GBPA45A12	SH2GBP45A512		1192.5 kcmil 54/19 Str. (1.333 Dia.)			12.00 [305]	

NOTES:

- Dimensions in brackets [] are in millimeters.
- For stainless steel hardware add SUFFIX "SS" to catalog number (example: S2GBP41ASS).
- For variations in cable spacing contact factory.
- For pad rotated 90° on S2GBPA-A add suffix R90 to the catalog number (example: S2GBPA44AR90).
- For Bolt Circles other than 5 inch on type SH2GBP-A contact factory.
- S2GBPA-A connectors rated 550 kV when used with type "STS" Shielding Caps. Ordered separately.

Type S2GPB-A (Spacer);
 Type S2GBPA-A (Terminal Tap);
 Type SH2GBP-A (Bus Support)
 (Continued)

Catalog Number			Cable Range		Cable Dia.		"L"	"J" Dia.
Fig. 1	Fig. 2	Fig. 3	AAC	ACSR	Min.	Max.		
S2GBP46A	S2GBPA46A	SH2GBP46A5	1590 kcmil 61 Str. (1.453 Dia.)	1272 kcmil 54/19 Str. (1.382 Dia.)	1.382 [35]	1.504 [38]	18.00 [457]	5/8"-11 X 1-3/4" LG. Alum. Alloy
S2GBP46A12	S2GBPA46A12	SH2GBP46A512	1600 kcmil 127 Str. (1.454 Dia.)	1431 kcmil 54/19 Str. (1.465 Dia.)			12.00 [305]	
S2GBP48A	S2GBPA48A	SH2GBP48A5	1750 kcmil 127 Str. (1.526 Dia.)	1590 kcmil 45/7 Str. (1.502 Dia.)	1.504 [38]	1.632 [41]	18.00 [457]	5/8"-11 X 2" LG. Alum. Alloy
S2GBP48A12	S2GBPA48A12	SH2GBP48A512	2000 kcmil 91 Str. (1.630 Dia.)	1750 kcmil 84/19 Str. (1.602 Dia.)			12.00 [305]	
S2GBP483A	S2GBPA483A	SH2GBP483A5	2000 kcmil 91 Str. (1.630 Dia.)	1890 kcmil 84/19 Str. (1.650 Dia.)	1.632 [41]	1.737 [44]	18.00 [457]	
S2GBP483A12	S2GBPA483A12	SH2GBP483A512	2250 kcmil 91 Str. (1.729 Dia.)	2167 kcmil 72/7 Str. (1.737 Dia.)			12.00 [305]	
S2GBP486A	S2GBPA486A	SH2GBP486A5	2300 kcmil 61 Str. (1.750 Dia.)	2167 kcmil 72/7 Str. (1.737 Dia.)	1.737 [44]	1.824 [46]	18.00 [457]	
S2GBP486A12	S2GBPA486A12	SH2GBP486A512	2500 kcmil 127 Str. (1.823 Dia.)	2156 kcmil 84/19 Str. (1.762 Dia.)			12.00 [305]	

NOTES:

1. Dimensions in brackets [] are in millimeters.
2. For stainless steel hardware add SUFFIX "SS" to catalog number (example: S2GBP41ASS).
3. For variations in cable spacing contact factory.
4. For pad rotated 90° on S2GBPA-A add suffix R90 to the catalog number (example: S2GBPA44AR90).
5. For Bolt Circles other than 5 inch on type SH2GBP-A contact factory.
6. S2GBPA-A connectors rated 550 kV when used with type "STS" Shielding Caps. Ordered separately.

Type S3GPB-A

Bolted Bundled Cable Spacers (3 Conductor)

Bolted Cable-to-Cable Spacer (Three Cables).

Material: Cast 356 Aluminum Alloy

Hardware: Aluminum Alloy

EHV Rated: Self Shielding up to 550 kV

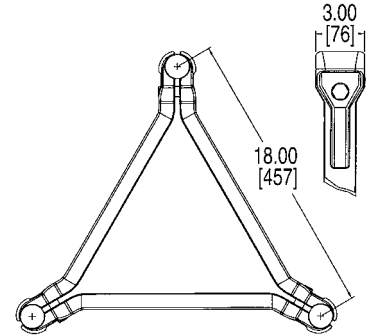

Catalog Number	Cable Range		Cable Dia.		"J" Dia.
	AAC	ACSR	Min.	Max.	
S3GBP41A	795 kcmil 37 Str. (1.036 Dia.) 874.5 kcmil 61 Str. (1.077 Dia.)	715 kcmil 24/7 Str. (1.036 Dia.) 715.5 kcmil 26/7 Str. (1.051 Dia.)	1.026 [26]	1.092 [28]	5/8"-11 x 1-1/2" LG. Alum. Alloy
S3GBP44A	954 kcmil 61 Str. (1.126 Dia.)	795 kcmil 24/7 Str. (1.092 Dia.) 795 kcmil 54/7 Str. (1.093 Dia.)	1.092 [28]	1.165 [30]	5/8"-11 x 1-3/4" LG. Alum. Alloy
S3GBP445A	1033.5 kcmil 37 Str. (1.170 Dia.) 1113 kcmil 61 Str. (1.216 Dia.)	954 kcmil 45/7 Str. (1.165 Dia.) 1033.5 kcmil 45/7 Str. (1.213 Dia.)	1.165 [30]	1.246 [32]	
S3GBP45A	1192 kcmil 61 Str. (1.258 Dia.) 1272 kcmil 61 Str. (1.300 Dia.)	1033.5 kcmil 54/7 Str. (1.246 Dia.) 1192.5 kcmil 54/19 Str. (1.333 Dia.)	1.246 [32]	1.382 [35]	
S3GBP46A	1590 kcmil 61 Str. (1.453 Dia.) 1600 kcmil 127 Str. (1.454 Dia.)	1272 kcmil 54/19 Str. (1.382 Dia.) 1431 kcmil 54/19 Str. (1.465 Dia.)	1.382 [35]	1.504 [38]	"5/8"-11 x 2" LG. Alum. Alloy"
S3GBP48A	1750 kcmil 127 Str. (1.526 Dia.) 2000 kcmil 91 Str. (1.630 Dia.)	1590 kcmil 47/7 Str. (1.502 Dia.) 1750 kcmil 84/19 Str. (1.602 Dia.)	1.504 [38]	1.632 [41]	
S3GBP483A	2000 kcmil 91 Str. (1.630 Dia.) 2250 kcmil 91 Str. (1.729 Dia.)	1890 kcmil 84/19 Str. (1.650 Dia.) 2167 kcmil 72/7 Str. (1.737 Dia.)	1.632 [41]	1.737 [44]	"5/8"-11 x 2" LG. Alum. Alloy"
S3GBP486A	2300 kcmil 61 Str. (1.750 Dia.) 2500 kcmil 127 Str. (1.823 Dia.)	2167 kcmil 72/7 Str. (1.737 Dia.) 2156 kcmil 84/19 Str. (1.762 Dia.)	1.737 [44]	1.824 [46]	

NOTES:

1. Dimensions in brackets [] are in millimeters.
2. For stainless steel hardware add SUFFIX "SS" to catalog number (example: S3GBP48ASS).
3. For variations in cable spacing contact factory.
4. For four hole straight pad tap or 90° version or bus support three bundled cable spacer, contact the factory.



Table of Contents

WEJTAP™ Connection System OverviewJ-3

WEJTAP™ System; Test DataJ-4

WEJTAP™ Ordering Information.....J-5

WEJTAP™ CoversJ-5

WEJTAP™ Selection Chart
by DiameterJ-6

WEJTAP™ for CopperJ-9

WEJTAP™ for Copper; Run/Tap
Ranges by ConnectorJ-10

WEJTAP™ STIRRUP™J-11

WEJTAP™ STIRRUP™ Selection Chart
by DiameterJ-11

WEJTAP™ Installation Tooling
and Accessories.....J-12

WEJTAP™ POWERLUG™J-13

WEJTAP™ Hotstick Accessories.....J-14

WEJTAP™ Kit Chart and Ordering
InstructionsJ-15

WEJTAP™ In-Line Disconnect Switch
.....J-16

WEJTAP™ Bolted Wedge In-Line
Disconnect SwitchJ-17



WEJTAP™ Booster Function Video
:55 Seconds



Closing the Breach Video
:22 Seconds



Removal of Booster Video
:27 Seconds



Connector Installation Video
2 min. 19 Seconds



Connector Removal Video
1 min. 57 Seconds



Slow Motion Installation Video
:18 Seconds



WEJTAP™ Tool Cleaning Video
2 min. 50 Sec.



Tightening of Tool Video
:26 Seconds



CPI Products.....J-19

WEJTAP™ Connection System

The WEJTAP™ System adds further dimension to the existing group of proven, reliable connection systems BURNDY has manufactured for over 70 years.

WEJTAP™ Components

WEJTAP™ Components are designed to provide a reliable system connection. The system consists of WEJTAP™ connectors, installation tooling (including a variety of hotline and lineman accessories) and a unique power booster.

WEJTAP™ Connectors

WEJTAP™ Connectors use an aluminum alloy wedge that is power-driven between the run and the tap cables locking them into a "C" shaped tempered aluminum alloy spring body. The spring body maintains consistent pressure throughout the life of the connection to ensure reliability during severe electrical and climatic conditions. The wedge's wiping action, combined with factory installed PENTX 1530, provides superior contact integrity. The wedge is automatically locked onto the spring body by a skiving action produced by a lance at the forward end of the WEJTAP™ installation tool.

WEJTAP™ Installation Tooling

The WEJTAP™ Installation Tool is a one-piece assembly that consists of a head and power unit. Two color-coded interchangeable heads accept all WEJTAP™ connectors and STIRRUP™. The design of the tool recognizes the need for simplicity and speed of operation as well as outstanding safety features, such as automatic gas release being vented away from the operator, fast simple breech loading, and fast advance when engaging the connector assembly. No loose parts to drop or misplace along with a booster ejector system that provides further safety to the operator. Fewer, simplified, hotline devices and handy lineman accessories complete the outstanding WEJTAP™ tooling package.



WEJTAP™ Power Booster

The WEJTAP™ Power Booster is a patented, self-contained device that provides the force necessary to drive the wedge into direct contact with the conductors. The booster is activated only when properly positioned in the tool assembly. A power cell in the booster is recessed to guard against premature discharge. The tool/booster system is designed to activate and deactivate the booster automatically should the operator decide to remove the tool from a connector prior to completing the installation. The deactivated booster may be safely removed from the tool.



Features and Benefits

- Large conductor chamfer on ends of wedge provide instant hand or visual identification of large run grooves; also ensure correct wedge orientation
- Color-coded WEJTAP™ connector and booster are packaged together for easy selection by the installer
- Factory inserted PENTX 1530 in grooves maintains low contact resistance, assists in protection against climatic conditions and is compatible with common insulations
- One piece installation tool, no project delays due to dropped or lost tool parts
- Fewer, and improved, hotstick accessories simplifies hotline installation and saves time
- Contained booster ejection system provides safety for the operator against the booster being ejected in the direction of the installer
- Automatic gas release vents away from the operator and eliminates manual gas venting improving safety
- Simplified loading speeds installation; no threading, just depress safety bar, twist and pull open; load by pushing and twisting prior to applying connector
- Features Acme-type threads providing smooth, fast engagement of tool and connector saving installation time

WEJTAP™ System; Test Data

The WEJTAP™ connectors have been subjected to extensive tests simulating the most severe service and weather conditions. In addition, the WEJTAP™ System meets or exceeds the industry standards of ANSI C119.4 Class 3, NEMA CC3 1973 Class AA, 500 Heat Cycles.

As with all BURNDY® connectors, the WEJTAP™ connectors have been designed to operate cooler than the attached conductors. The WEJTAP™ connectors have also been subjected to the ASTM B117-73 Salt Spray Test.

WEJTAP™ Information

WEJTAP™ C-member bodies are color-coded and marked with nominal conductor run and tap ranges. WEJTAP™ connector packages are labeled with a variety of common conductors with their nominal ranges.

WEJTAP™ connector wedges are marked with nominal ACSR, Aluminum, and Copper concentric standard conductors:

- Red WEJTAP™ connector range is Run: #8-1/0; Tap: #8-2
- Blue WEJTAP™ connector range is Run: #2-300 kcmil; Tap: #6-300 kcmil
- Yellow WEJTAP™ connector range is Run: 266.8-1590 kcmil; Tap: #6-1590 kcmil

All WEJTAP™ wedges contain a clearly defined chamfer on the large end of the run conductor groove to identify the "large run" groove. Installers will appreciate the convenience of visual or hand identification for correct wedge positioning.

WEJTAP™ wedges are driven between the run and tap conductors and activate the spring characteristics of the "C" shaped body. This action maintains contact pressure even when the connection is subjected to severe climatic and electrical conditions.



RUS Accepted

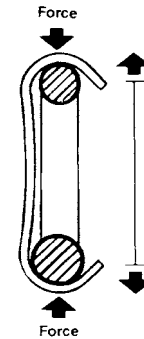
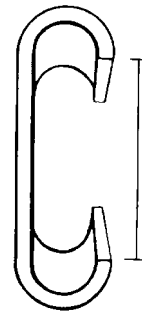

ANSI C119.4 - 1986 Heat Cycle Test

Average Temperature Rise vs. Current Cycles

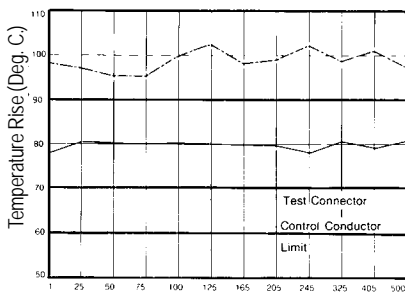

Detailed test report packages are available upon request.

ASTM Salt Spray Test

Average % Relative Resistance vs. Hours of Salt Spray Exposure

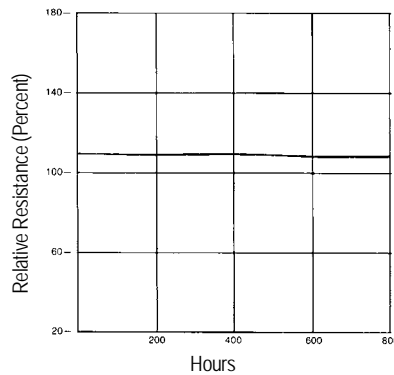

WEJTAP™ Connection System

The BURNDY® WEJTAP™ Connection System has a wide variety of connectors available for many different conductor ranges.

Color coded boosters and connectors ensure proper matching during installation.

The BURNDY® Power Booster is designed and engineered for the highest reliability and safety. Proven rimfire design means misfires are almost nonexistent. Close manufacturing component tolerances provide maximum resistance to moisture or submersion.

WEJTAP™ Ordering Information

Power boosters may be ordered separately in boxes of 25.

Red Boosters: **WPBRNBOX25**
Blue Boosters: **WPBBNBOX25**
Yellow Boosters: **WPBYNBOX25**

Select appropriate connector, match with equal number of color coded boosters.

For information about conductors which are not listed, or further information, contact BURNDY® Customer Service at 1-800-346-4175.



WEJTAP™ Cover

BURNDY® WEJTAP™ Covers are installed on WEJTAP™ connectors to prevent them from coming in contact with other taps or exposed ground points. The covers are rugged snap-on devices available in four sizes to cover all connector sizes.



Cover Catalog Number	WEJTAP™ Size	Nominal Conductor Range Run	Nominal Conductor Range Tap	Cover Color
WCCR	Small Old Style Red	8-10	8-2	Black Weather Rated
WCCB	Red & Blue	2-300	6-300	
WCCSY	Small (Yellow)	300-556.50	6-556.50	
WCCLY	Large (Yellow)	556.50-1033.50	556.5-1033.50	

WEJTAP™ Selection Chart
By Diameter

Catalog Number	Sum of Diameters		Run		Tap	
	Max	Min	Max	Min	Max	Min
Installed with red booster						
WCR29	0.723	0.584	0.398	0.257	0.398	0.257
WCR30	0.649	0.516	0.398	0.257	0.325	0.206
WCR31	0.602	0.464	0.398	0.257	0.258	0.162
WCR32	0.530	0.410	0.326	0.204	0.258	0.162
WCR33	0.459	0.331	0.258	0.169	0.230	0.162
WCR34	0.324	0.256	0.162	0.128	0.162	0.128
WCR35	0.560	0.452	0.398	0.257	0.162	0.128
WCR36	0.487	0.387	0.398	0.257	0.162	0.128
WCR37	0.416	0.297	0.258	0.169	0.162	0.128
Installed with blue booster						
WCB10	0.795	0.621	0.482	0.316	0.437	0.257
WCB11	0.901	0.763	0.568	0.364	0.457	0.257
WCB12	0.707	0.526	0.568	0.364	0.204	0.162
WCB13	0.761	0.600	0.568	0.364	0.258	0.204
WCB14	0.839	0.690	0.568	0.364	0.398	0.257
WCB15	0.769	0.622	0.568	0.364	0.204	0.162
WCB16	0.823	0.664	0.568	0.364	0.258	0.204
WCB17	0.963	0.804	0.568	0.364	0.464	0.257
WCB18	1.011	0.867	0.568	0.364	0.572	0.364
WCB19	1.068	0.938	0.568	0.364	0.572	0.379
WCB20	1.130	0.975	0.568	0.364	0.572	0.386
WCB21	0.846	0.711	0.650	0.532	0.204	0.162
WCB22	0.900	0.765	0.650	0.532	0.258	0.204
WCB23	0.972	0.818	0.650	0.532	0.330	0.257
WCB24	1.052	0.897	0.650	0.532	0.500	0.324
WCB25	1.104	0.963	0.650	0.532	0.562	0.364
WCB26	1.163	1.015	0.650	0.532	0.562	0.409
WCB27	1.221	1.080	0.650	0.532	0.575	0.460
WCB28	1.284	1.141	0.650	0.532	0.650	0.525
WCB40	0.888	0.762	0.684	0.603	0.204	0.162
WCB41	0.942	0.794	0.684	0.600	0.258	0.204
WCB42	1.011	0.857	0.684	0.600	0.333	0.257
WCB43	1.094	0.936	0.684	0.600	0.500	0.324
WCB44	1.146	1.009	0.684	0.600	0.562	0.364
WCB45	1.204	1.057	0.684	0.600	0.562	0.409
WCB46	1.284	1.119	0.684	0.600	0.592	0.460
WCB47	1.368	1.188	0.684	0.600	0.684	0.600
Installed with yellow booster						
WCY48	0.932	0.765	0.750	0.537	0.204	0.162
WCY49	1.012	0.807	0.750	0.537	0.271	0.203
WCY50	1.069	0.860	0.750	0.537	0.355	0.257
WCY51	1.141	0.927	0.750	0.537	0.557	0.324
WCY52	1.190	1.001	0.750	0.537	0.588	0.364

WEJTAP™ Selection Chart
By Diameter (Continued)

Catalog Number	Sum of Diameters		Run		Tap	
	Max	Min	Max	Min	Max	Min
Installed with yellow booster						
WCY53	1.236	1.012	0.750	0.537	0.619	0.409
WCY54	1.302	1.063	0.750	0.537	0.630	0.46
WCY55	1.370	1.140	0.750	0.537	0.714	0.499
WCY56	1.456	1.245	0.750	0.537	0.750	0.524
WCY57	1.190	0.979	0.893	0.666	0.326	0.257
WCY58	1.087	0.931	0.893	0.666	0.258	0.198
WCY59	1.061	0.891	0.893	0.666	0.199	0.162
WCY60	1.854	1.686	0.950	0.722	0.950	0.722
WCY61	1.741	1.524	0.940	0.683	0.940	0.666
WCY62	1.594	1.379	0.940	0.683	0.750	0.573
WCY63	1.500	1.297	0.940	0.683	0.750	0.481
WCY64	1.421	1.216	0.940	0.683	0.650	0.436
WCY65	1.360	1.147	0.940	0.683	0.562	0.382
WCY66	1.305	1.097	0.940	0.683	0.562	0.336
WCY67	1.270	1.054	0.940	0.683	0.450	0.315
WCY68	1.253	1.115	0.940	0.683	0.326	0.257
WCY69	1.187	1.059	0.940	0.683	0.262	0.204
WCY70	1.130	1.013	0.940	0.683	0.204	0.162
WCY71	2.216	2.074	1.133	0.907	1.156	0.947
WCY72	2.133	1.999	1.133	0.907	1.142	0.927
WCY73	2.098	1.946	1.133	0.907	1.142	0.907
WCY74	2.035	1.891	1.133	0.907	1.142	0.858
WCY75	1.969	1.822	1.133	0.889	0.927	0.763
WCY76	1.901	1.741	1.133	0.889	0.900	0.700
WCY77	1.829	1.677	1.133	0.889	0.750	0.575
WCY78	1.750	1.599	1.133	0.889	0.729	0.525
WCY79	1.670	1.526	1.133	0.889	0.722	0.364
WCY80	1.610	1.466	1.133	0.889	0.608	0.364
WCY81	1.555	1.411	1.133	0.889	0.608	0.364
WCY82	1.506	1.362	1.133	0.889	0.436	0.324
WCY83	1.440	1.288	1.133	0.889	0.398	0.257
WCY84	1.369	1.221	1.133	0.889	0.333	0.203
WCY85	1.306	1.158	1.133	0.889	0.258	0.162
WCY86	2.496	2.332	1.250	0.893	1.250	1.000
WCY87	2.418	2.251	1.250	0.893	1.250	0.856
WCY88	2.354	2.194	1.250	0.893	1.211	0.971
WCY89	2.297	2.137	1.250	0.893	1.200	0.923
WCY90	2.238	2.083	1.250	0.893	1.159	0.868
WCY91	2.173	2.013	1.250	0.893	1.130	0.856
WCY92	2.104	1.950	1.250	0.893	0.904	0.720
WCY93	2.029	1.869	1.250	0.893	0.900	0.700
WCY94	1.967	1.831	1.250	0.893	0.750	0.588
WCY95	1.888	1.728	1.250	0.893	0.722	0.525
WCY96	1.811	1.648	1.250	0.893	0.609	0.364
WCY97	1.748	1.591	1.250	0.893	0.598	0.385
WCY98	1.695	1.533	1.250	0.893	0.598	0.364
WCY99	1.644	1.489	1.250	0.893	0.398	0.324
WCY100	1.572	1.400	1.250	0.893	0.351	0.257

WEJTAP™ Selection Chart
By Diameter (Continued)

Catalog Number	Sum of Diameters		Run		Tap	
	Max	Min	Max	Min	Max	Min
Installed with yellow booster						
WCY101	1.503	1.343	1.250	0.893	0.261	0.204
WCY102	1.454	1.284	1.250	0.893	0.198	0.162
WCY103	2.604	2.484	1.302	1.242	1.302	1.242
WCY104	2.567	2.407	1.302	1.242	1.265	1.165
WCY105	2.489	2.329	1.302	1.242	1.187	1.087
WCY106	2.418	2.258	1.302	1.242	1.116	1.016
WCY107	2.373	2.213	1.302	1.242	1.071	0.971
WCY108	2.318	2.158	1.302	1.242	1.016	0.916
WCY109	2.255	2.095	1.302	1.242	0.953	0.853
WCY110	2.179	2.019	1.302	1.242	0.877	0.777
WCY111	2.102	1.942	1.302	1.242	0.800	0.700
WCY112	2.044	1.884	1.302	1.242	0.742	0.642
WCY113	1.961	1.801	1.302	1.242	0.659	0.559
WCY114	1.940	1.740	1.350	1.242	0.590	0.498
WCY115	1.863	1.663	1.350	1.242	0.513	0.421
WCY116	1.812	1.612	1.350	1.242	0.462	0.370
WCY117	1.762	1.562	1.350	1.242	0.412	0.320
WCY118	1.703	1.503	1.350	1.242	0.353	0.261
WCY119	1.631	1.431	1.350	1.242	0.281	0.189
WCY120	1.580	1.380	1.350	1.242	0.230	0.138
WCY121	2.844	2.642	1.422	1.314	1.422	1.328
WCY122	2.764	2.562	1.422	1.314	1.342	1.248
WCY123	2.680	2.479	1.422	1.314	1.258	1.164
WCY124	2.596	2.394	1.422	1.314	1.174	1.080
WCY125	2.535	2.333	1.422	1.314	1.113	1.019
WCY126	2.481	2.279	1.422	1.314	1.059	0.965
WCY127	2.426	2.224	1.422	1.314	1.004	0.910
WCY128	2.376	2.174	1.422	1.314	0.954	0.860
WCY129	2.286	2.084	1.422	1.314	0.864	0.770
WCY130	2.216	2.014	1.422	1.314	0.794	0.700
WCY131	2.152	1.950	1.422	1.314	0.730	0.636
WCY132	2.070	1.868	1.422	1.314	0.648	0.554
WCY133	1.990	1.786	1.422	1.314	0.568	0.472
WCY134	1.931	1.729	1.422	1.314	0.509	0.415
WCY135	1.876	1.674	1.422	1.314	0.454	0.360
WCY136	1.831	1.629	1.422	1.314	0.409	0.315
WCY137	1.771	1.569	1.422	1.314	0.349	0.255
WCY138	1.706	1.504	1.422	1.314	0.284	0.190
WCY139	1.664	1.462	1.422	1.314	0.242	0.148
WCY140	3.045	2.090	1.533	1.471	1.547	1.471
WCY145	2.596	2.534	1.533	1.032	1.094	1.032

WEJTAP™ for Copper, Type WCB-C
Connection System for Copper

The BURNDY® Copper WEJTAP™ powder actuated copper connectors are designed for overhead copper-to-copper tap applications.

Features and Benefits

- Expanded range taking capabilities
- Larger size connector for #6 to #2 applications
- Uses standard WEJTAP™ installation tooling
- Meets latest ANSI C119.4 (2011) including optional fault current test annex
- Prefilled with PENETROX™ E to improve the performance over the life of the connection

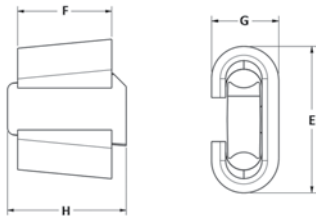

Catalog Number	Copper Conductor Dia. Accommodated (in)			Dimensions				Tooling	Installation Booster Color	Fault Current Rating (KA)
	Run Range	Tap Range	Sum Range	E	F	G	H			
WCB4C4	0.162 - 0.258	0.162 - 0.232	0.324 - 0.464	2.40	1.63	1.02	2.05	WTHRB-1S	Blue	12.50
WCB2C2	0.258 - 0.368	0.162 - 0.292	0.452 - 0.600							
WCB10C2	0.292 - 0.376	0.162 - 0.292	0.524 - 0.665							
WCB20C2	0.300 - 0.430	0.162 - 0.292	0.576 - 0.734							
WCB20C20		0.300 - 0.414	0.710 - 0.844							
WCB30C2	0.360 - 0.516	0.162 - 0.292	0.622 - 0.775							12.50
WCB40C2	0.375 - 0.538	0.162 - 0.292	0.680 - 0.822							
WCB40C20		0.330 - 0.464	0.814 - 0.952							
WCB40C40		0.375 - 0.538	0.936 - 1.072							
WCB250C2	0.435 - 0.574	0.162 - 0.292	0.730 - 0.875							12.50
WCB250C20		0.293 - 0.430	0.875 - 1.033							
WCB250C250		0.431 - 0.574	1.033 - 1.150							



BURNDY Catalog Number:
WCB4C4

RUN	TAP
#6 CU SOL	#6 CU SOL
#6 CU STR	#6 CU SOL - #6 CU STR
#4 CU SOL	#6 CU SOL - #4 CU SOL
#4 CU STR	#4 CU STR - #6 CU SOL
#2 CU SOL	#6 CU SOL - #6 CU STR

BURNDY Catalog Number:
WCB2C2

RUN	TAP
#2 CU SOL	#4 CU SOL - #2 CU SOL
#2 CU STR	#6 CU SOL - #2 CU STR
1/0 CU STR	#6 CU SOL - #4 CU STR

BURNDY Catalog Number:
WCB10C2

RUN	TAP
#2 CU STR	#4 CCS* - #2 CU STR
1/0 CU SOL	#6 CU SOL - #2 CU STR
1/0 CU STR	#6 CU SOL - #2 CU STR

BURNDY Catalog Number:
WCB20C2

RUN	TAP
1/0 CU STR	#2 CU SOL - #2 CU STR
2/0 CU STR	#6 CU SOL - #2 CU STR

BURNDY Catalog Number:
WCB20C20

RUN	TAP
1/0 CU STR	1/0 CU STR
2/0 CU STR	1/0 CU STR - 2/0 CU STR

BURNDY Catalog Number:
WCB30C2

RUN	TAP
4/0 CU SOL	#6 CU SOL - #2 CU STR

BURNDY Catalog Number:
WCB40C2

RUN	TAP
4/0 CU STR	#6 CU SOL - #2 CU STR

BURNDY Catalog Number:
WCB40C20

RUN	TAP
3/0 CU STR	1/0 CU STR - 3/0 CU STR
4/0 CU STR	1/0 CU STR - 2/0 CU STR

BURNDY Catalog Number:
WCB40C40

RUN	TAP
4/0 CU STR	4/0 CU SOL - 4/0 CU STR

BURNDY Catalog Number:
WCB250C2

RUN	TAP
250 CU STR	#6 CU SOL - #2 CU STR

BURNDY Catalog Number:
WCB250C20

RUN	TAP
250 CU STR	1/0 CU STR - 2/0 CU STR

BURNDY Catalog Number:
WCB250C250

RUN	TAP
250 CU STR	4/0 CU SOL - 250 CU STR

* Copper Clad Steel

WEJTAP™ STIRRUP™

Large Run Conductor position is identified on all wedges via a distinct chamfer.

QIK Selector - for common ACSR, Aluminum and Copper Conductors



Catalog Number	Nominal Cable Range	Bail Size
Small Red Cable Range 6-2		
WSS1	6	2
WSS2	5, 4, 2	
Medium Blue Cable Range 1-300		
* WSM1	2, 1, 1/0, 2/0	2
WSM2	2/0, 3/0	2
WSM3	3/0 - 4/0	2
WSM4		2/0
WSM5	266.8	2
WSM6		1/0
WSM7	350	1/0
WSM11	266.8 - 336.4	4/0

Catalog Number	Nominal Cable Range	Bail Size
Large Yellow Cable Range 300-1033.5		
WSL1	336.4	1/0
WSL2		2/0
WSL3		4/0
WSL4	397.5 - 477	1/0
WSL5		2/0
WSL6		4/0
WSL7	556.5	1/0
WSL8		2/0
WSL9		4/0
WSL10	636	4/0
WSL11		2/0
WSL12	795	2/0
WSL13		4/0
WSL14	1033.5	4/0

* WSM1 now accepts #2 conductor

WEJTAP™ STIRRUP™ Selection Chart

By Diameter

Catalog Number	Sum of Diameters		Run		Tap	
	Max.	Min.	Max.	Min.	Max.	Min.
Small stirrups						
WSS1	0.454	0.412	0.204	0.162	0.250	0.250
WSS2	0.575	0.456	0.325	0.206	0.250	0.250
Medium sized stirrups						
WSM1	0.697	0.575	0.447	0.325	0.250	0.250
WSM10	0.887	0.784	0.563	0.460	0.324	0.324
WSM2	0.752	0.615	0.502	0.365	0.250	0.250
WSM3	0.813	0.660	0.563	0.410	0.250	0.250
WSM4	0.938	0.835	0.563	0.460	0.375	0.375
WSM5	0.892	0.787	0.642	0.537	0.250	0.250
WSM6	0.968	0.861	0.642	0.537	0.324	0.324
WSM7	1.008	0.898	0.684	0.574	0.324	0.324
WSM8	0.934	0.824	0.684	0.574	0.250	0.250
WSM9	0.771	0.649	0.447	0.325	0.324	0.324
Large stirrups						
WSL1	1.050	0.927	0.726	0.603	0.324	0.324
WSL10	1.479	1.389	1.019	0.929	0.460	0.460
WSL11	1.394	1.304	1.019	0.929	0.375	0.375
WSL12	1.515	1.399	1.140	1.024	0.375	0.375
WSL13	1.600	1.484	1.140	1.024	0.460	0.460
WSL14	1.708	1.606	1.248	1.146	0.460	0.460
WSL2	1.101	0.978	0.726	0.603	0.375	0.375
WSL3	1.186	1.063	0.726	0.603	0.460	0.460
WSL4	1.186	1.046	0.862	0.722	0.324	0.324
WSL5	1.237	1.097	0.862	0.722	0.375	0.375
WSL6	1.322	1.182	0.862	0.722	0.460	0.460
WSL7	1.251	1.170	0.927	0.846	0.324	0.324
WSL8	1.302	1.221	0.927	0.846	0.375	0.375
WSL9	1.387	1.306	0.927	0.846	0.460	0.460

WEJTAP™ Installation Tooling and Accessories



Type WTB

The WEJTAP™ patented tool body is a one-piece assembly basic drive mechanism used to install WEJTAP™ and STIRRUP™ connectors ranging from #8 AWG through 1590 kcmil ACSR.



Type WTHRB1S

WEJTAP™ tool head operating platform for small and medium range (red/blue coded) connectors.



Type WTHY1S

WEJTAP™ tool head operating platform for medium and large range (yellow coded) connectors.



Type WTOCY

WEJTAP™ removal clip for red type II and medium (blue coded) tap connectors used with type WTHRB tool head.



Type WTOCBR

WEJTAP™ removal clip for large (yellow coded) tap connectors used with type WTHY tool head.



Type WTCK

WEJTAP™ tool cleaning/maintenance kit for use with type WTB tool body.



Type WTBASY1

WEJTAP™ ram replacement assembly.

WEJTAP™ POWERLUG™

WEJTAP™ POWERLUG™ terminals are made of cast aluminum alloy for termination of ACSR and aluminum conductors.

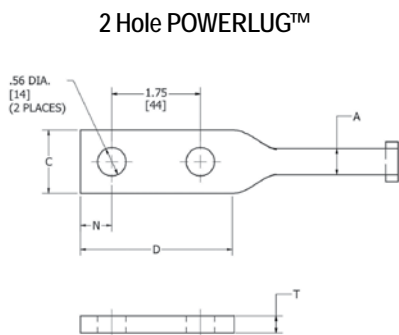

Fig. 1

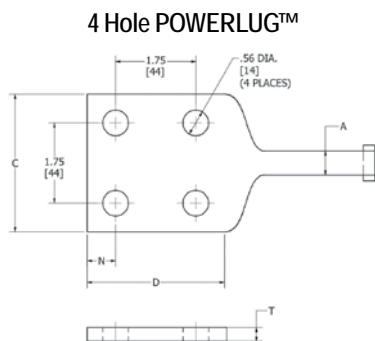

Fig. 2

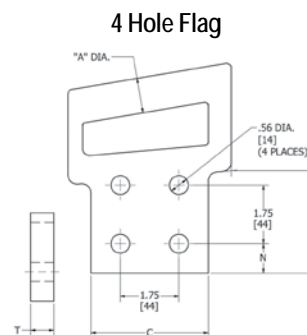

Fig. 3

Catalog Number	Tap Groove for Connector Selection	Standard Conductor		Figure No.	Holes in Pad	Dimension			
		ACSR	ASC/AAC			C	D	N	T
WCAB30R2N	4/0 Standard ACSR (.563 in OD)	6 Str. - 266.8	6 Str. - 300	1	2	1-1/4	3	5/8	0.34
WCAB30R4N				2	4	3	3	5/8	0.30
WCBB30R4N				3	4	3	3	5/8	0.30
WCAY39R2N	336.4 Standard ACSR (.721 in OD)	266.8 - 556.5	336.4 - 636	1	2	1-3/4	3	5/8	0.34
WCAY39R4N				2	4	3	3	5/8	0.30
WCBY39R4N				3	4	3	3	5/8	0.30
WCAY49R2N	795 Standard ACSR (1.06 in OD)	605 - 1033.5	715.5 - 1113	1	2	1-3/4	3-1/2	7/8	0.69
WCAY49R4N				2	4	3-1/2	3-1/2	7/8	0.69
WCBY49R4N				3	4	3-1/2	3-1/2	7/8	0.69

NOTE: The recommended connector and booster are ordered separately. Catalog number is for the POWERLUG™ only. Use the Tap Groove Connector diameter, along with the application run conductor diameter, to choose the correct WEJTAP™ connector.

MULTIPLE CONDUCTOR TAP APPLICATION

Connector	*Run Groove	*Tap Groove
WCY64PB	Three - 1/0 ACSR (6/1) Diameter = 0.398	One - 4/0 ACSR (6/1) Diameter = 0.563
WCY65PB	Three - 1/0 ACSR (6/1) Diameter = 0.398	One - 3/0 ACSR (6/1) Diameter = 0.502
WCY63PB	Three - 2/0 ACSR (6/1) Diameter = 0.447	One - 4/0 ACSR (6/1) Diameter = 0.563
WCB11PB	Three - #4 stranded Diameter = 0.232	One - 1/0 ACSR (6/1) Diameter = 0.398
WCY54PB	Three - 1/0 stranded Diameter = 0.368	One - 4/0 stranded Diameter = 0.522
WCY53PB	Three - 1/0 stranded Diameter = 0.368	One - 3/0 stranded Diameter = 0.464
WCY64PB	Three - 2/0 stranded Diameter = 0.414	One - 4/0 stranded Diameter = 0.522
WCB11PB	Three - #4 stranded Diameter = 0.232	One - 1/0 stranded Diameter = 0.368

* Electrically, the three smaller conductors are the likely taps, however, during installation, they are located in the larger run groove due to their larger aggregate sum.



Type WHSCWH

WEJTAP™ hotstick connector clamp used to hold the tap connector spring-body and wedge for installation on energized lines with the shotgun hotstick.



Type WHSWHADP

WEJTAP™ hotstick angle wedge holder adapter attaches wedge clamp to universal hotstick for hotline installation.



Type WHSWB

WEJTAP™ hotstick wirebrush attaches to the universal hotstick for cleaning the contact surface of the line conductor.



Type WHSPBC

WEJTAP™ hotstick dual cable clamp used to hold run and tap conductors in position during hotline installation. Universal for all applications from #8-1272 ACSR.

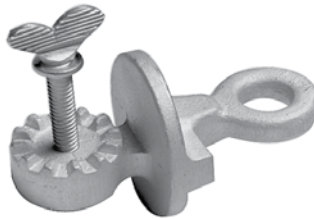

Type WCHAWAS

WEJTAP™ hotstick angle wedge holder adapter attaches wedge clamp to universal hotstick for hotline installation with shotgun stick.



Type WHSGB

WEJTAP™ hotstick breech drive. Geared shotgun hotstick adapter easily latches to the breech end of WEJTAP™ installation tool with disassembly for use on energized lines.



Type WHSSADP

WEJTAP™ hotstick spring loaded 90 degree adapter, used to attach tool to universal hot-stick for hotline installations.



Type WHSTA

WEJTAP™ hotstick tool (actuator) hammer attaches to the universal hotstick for striking the tool actuator button to complete the installation.

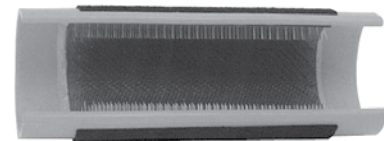

Type WHHWB

WEJTAP™ hand-held wire brush for cleaning surface contact areas on non-energized conductors.

WEJTAP™ KIT ORDERING INSTRUCTIONS



Type WTCC
(Carrying Case Only)

WEJTAP™ plastic carrying case. Designed for rugged use in all weather conditions. It accommodates WEJTAP™ installation tool, removal clips, and cleaning kit.



Type WABAG

WEJTAP™ accessories bag is designed for use in carrying installation tool(s), removal clips, and cleaning kit. Hotstick accessories may be accommodated as well. Holders for power boosters are conveniently located on the outside of the bag.

	*Non-Hot Stick Power Unit	Hot Stick Power Unit	Self-Firing Tool	Large Frame (Yellows)	Large Frame Take Off Clip	Small Frame (Red, Blue)	Cleaning Kit	Small Frame Take Off Clip	Molded Carrying Case	Canvas Style Tool Bag
Component Kit Catalog No.	WTBNHS	WTB	WTBGBW	WTHY1S	WTOCY	WTHRB1S	WTCK	WTOCBR	WTCC	WABAG
WT2B2RBYWABAG		2		1	1	1	1	1		1
WT2BRBYWABAG		2				1	1	1		1
WTRBYK		1		1	1	1	1	1	1	
WTRBYKNHS	1			1	1	1	1	1	1	
WTYK		1		1	1		1			
WTYKNHS	1			1	1		1			
WTRBK		1				1	1	1	1	
WTRBKNHS	1					1	1	1	1	
WT2BRBYK		2		1	1	1	1	1	1	
WT2B2RBYK		2		1	1	2	1	1	1	
WTY		1		1			1			
WTRB		1				1	1			
WTYWABAG		1		1	1		1			1
WTYKNHSBAG	1			1	1		1			1
WTRBWABAG		1				1	1	1		1
WTRBKNHSBAG	1					1	1	1		1
WTBGBWRBYK			1	1	1	1	1	1	1	
WTRBYWABAG		1		1	1	1	1	1		1
WTRBYKNHSBAG	1			1	1	1	1	1		1

* Non-Hotstick power units do not contain features allowing activation with Hotsticks. They are not upgradeable.

**Contact your BURNDY® representative for a WEJTAP™ demonstration
or contact the factory at 1-800-346-4175**

WEJTAP™ In-Line Disconnect

The BURNDY® In-Line Disconnect utilizes proven WEJTAP™ technology in combination with industry standard components to provide reliable performance of switch applications.

1. Utilizes WEJTAP™ connectors for securing the switch to the distribution line in tension applications.
2. Utilizes industry recognized and proven GST&D Products, LTD. blade components along with dual Advance Rubber Products, Inc., Insulators attached to a BURNDY® designed yoke plate assembly.
3. WEJTAP™ In-Line Disconnect designed for use in gloving and hot stick applications in conjunction with an industry standard load break tool.
4. Dual insulators minimize the switch movement during opening and closing of the blade.
5. Installation steps are minimized. The switch can be snapped directly on the line and secured with our conductor pivot retainer, designed into the switch frame.
6. WEJTAP™ tooling is used to secure the "C Member" to the built-in wedge feature of the frame. Providing reliable mechanical and electrical performance.
7. The blade is positioned on the switch to simplify cutting the conductor during installation.
8. In-Line Disconnect is removable and reuseable.
9. Other conductor sizes available. Please contact factory.



Product Specifications

Voltage:	15 kV (110 kV BIL), 29 kV (150 kV BIL), 35 kV (200 kV BIL)
Current:	900 Ampere RMS
Short Circuit:	Momentary Current 40,000 Ampere RMS, Asymmetrical Three Second Current 25,000 Ampere RMS, Symmetrical
Strength:	Body 10,000 lbs. Pulling Eye 6,000 lbs.
Insulators:	Silicone
Meets Industry Standards:	ANSI C119.4, C37.32 IEEE C37.30, C37.34 CSA C83.71 ASTM B117 Salt Fog

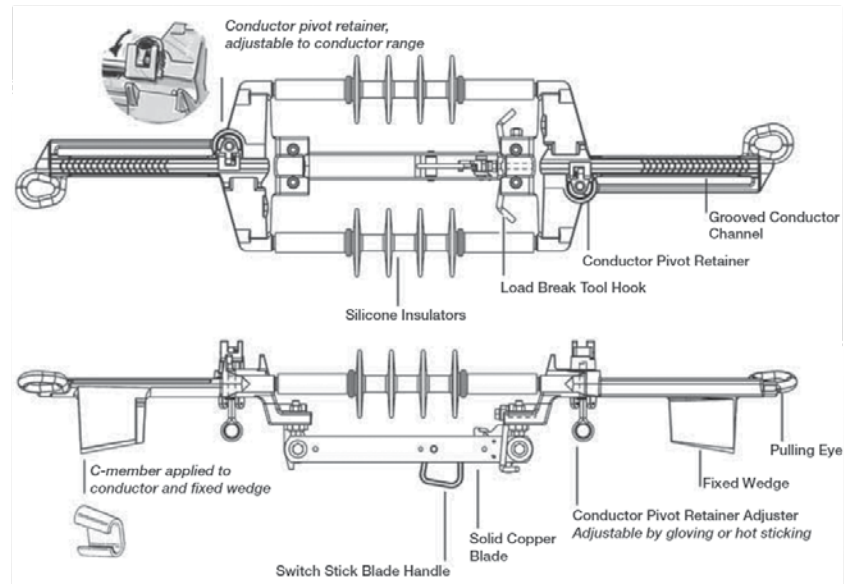

Catalog Number	KV/BIL Ratings	Conductor Dia. Range	Common Conductors		Replacement Tap
			ACSR	AAC	
WAD1015	15 kV/110 kV BIL	0.398" - 0.502"	1/0 (6/1), 2/0 (6/1), 3/0 (6/1)	2/0, 3/0	WADRT1
WAD1029	29 kV/150 kV BIL				
WAD1035	35 kV/200 kV BIL				
WAD4015	15 kV/110 kV BIL	0.522" - 0.609"	4/0 (6/1), 266.8 (18/1)	4/0, 250, 266.8 (7 Str. , 19 Str.), 336 compact	WADRT1
WAD4029	29 kV/150 kV BIL				
WAD4035	35 kV/200 kV BIL				
WAD33615	15 kV/110 kV BIL	0.642" - 0.723"	266.8 (26/7, 30/7) 336.4 (18/1, 26/7)	336, 350, 397.5, 477 compact	WADRT2
WAD33629	29 kV/150 kV BIL				
WAD33635	35 kV/200 kV BIL				
WAD47715	15 kV/110 kV BIL	0.741" - 0.814"	336.4 (30/7), 397.5 (All Str.), 477 (18/1)	477 (19 Str. , 37 Str.), 500 (19 Str. , 37 Str.), 556 compact	WADRT1
WAD47729	29 kV/150 kV BIL				
WAD47735	35 kV/200 kV BIL				
WAD55615	15 kV/110 kV BIL	0.846" - 0.883"	477 (24/7, 26/7, 30/7), 556 (18/1)	556 (19 Str. , 37 Str.)	WADRT2
WAD55629	29 kV/150 kV BIL				
WAD55635	35 kV/200 kV BIL				
WAD79515	15 kV/110 kV BIL	0.953" - 1.040"	556 (26/7, 30/7), 795 (36/1)	795 (37 Str. , 61 Str.)	WADRT3
WAD79529	29 kV/150 kV BIL				
WAD79535	35 kV/200 kV BIL				

Type WAD-M
Bolted Wedge In-Line Disconnect Switch

Combining the best features of the WEJTAP™ In-Line Disconnect Switch, the Type WAD-M Bolted Wedge enhances the range taking capabilities with an innovative hybrid bolted connector while maintaining the time savings features.

1. Bolted hybrid connector combines bolted technology with wedge features to make a reliable connection while taking the guess work of knowing when "tight is tight".
2. Spring loaded pivot retainer snaps onto the conductor freeing the hands of the installer to quickly and safely complete the installation.
3. Dual insulators minimize the switch rotation during opening and closing, especially in mid-span applications.
4. The switch can be easily removed and reused (reconditioning required).

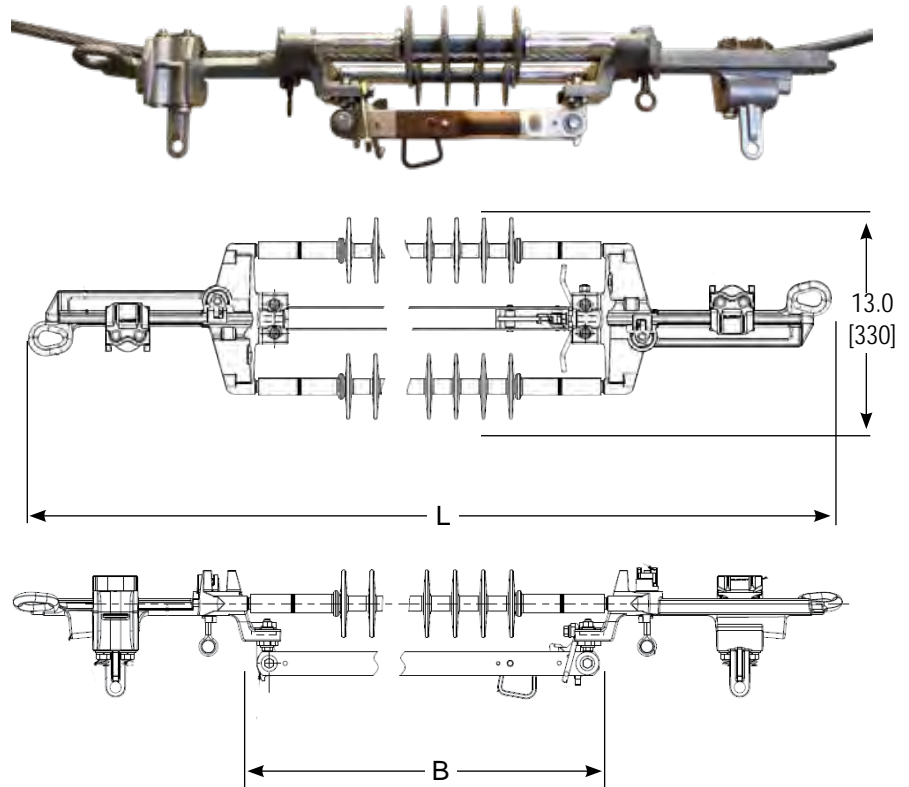

Product Specifications

Voltage: 15 kV (110 kV BIL)
29 kV (150 kV BIL)
35 kV (200 kV BIL)

Current: 900 Ampere RMS

Strength: Body 10,000 lbs

Catalog Number	kV / BIL Ratings	Conductor Dia. Range	Conductors		Replacement Connector	Dimensions	
			ACSR	AAC		L (in) [mm]	B (in) [mm]
WADM33615	15 kV / 110 kV BIL	0.398" - 0.72"	1/0 (6/1) to 336.4 (18/1)	2/0 (7) (19) to 350 (19)	WADM336CON	45 [1140]	13.4 [340]
WADM33629	29 kV / 150 kV BIL					49 [1250]	17.9 [455]
WADM33635	35 kV / 200 kV BIL					54 [1370]	22.4 [569]
WADM55615	15 kV / 110 kV BIL	0.721" - 0.927"	336.4 (26/7) to 556.5 (26/7)	397.5 (19) to 556 (19)	WADM556CON	45 [1140]	13.4 [340]
WADM55629	29 kV / 150 kV BIL					49 [1250]	17.9 [455]
WADM55635	35 kV / 200 kV BIL					54 [1370]	22.4 [569]
WADM79515	15 kV / 110 kV BIL	0.927" - 1.040"	556.5 (26/7) to 795 (36/1)	650 (37) to 795 (37)	WADM795CON	45 [1140]	13.4 [340]
WADM79529	29 kV / 150 kV BIL					49 [1250]	173.9 [445]
WADM79535	35 kV / 200 kV BIL					54 [1370]	22.4 [569]

Tightening torque for all sizes is 480 in-lbs; 3/4" wrench

OH Distribution & Transmission

This Page Intentionally Left Blank



Table of Contents



CPI Shear Bolt Wedge Tap Connectors - Aluminum
 #4-4/0 Series Aluminum Tap J-20
 350 kcmil Series Aluminum Tap J-21
 336.4-636 kcmil Series Aluminum Tap J-22
 795-1272 Series Aluminum Tap J-23
 Shear Bolt Wedge Tap Connector Selection Chart J-24

CPI Shear Bolt Wedge Tap Connectors - Copper
 #4-350 kcmil Series Copper Tap J-26

CPI Tap Cover
 Fits Connectors 336.4-1272 AAC J-27

CPI Bolted Wedge Terminals - Aluminum
 #6-795 AAC Expanded Range Taking; fit 2-hole NEMA pads J-28

CPI Shear Bolt Wedge Stirrups
 #6-4/0 ACSR; Available with 1/0 or 2/0 Bail J-29

CPI Shear Bolt Wedge Stirrups - Aluminum
 #4-397.5 AAC J-30
 226.8 ACSR 30/7 - 1272 AAC J-31

CPI Bolted Wedge Stirrups - Copper
 #6-350 kcmil J-32

CPI Paddle Stirrups
 Bronze, Tin-Plated, Bi-Metallic J-33

CPI Bolted Wedge Aluminum Pad Tap Connectors
 #2-1590 AAC 61 J-34

CPI Bolted Wedge Piggy-Back Clamps - Aluminum
 #8-653.9 ACSR J-35

CPI Bolted Wedge Hotline Tap Connectors - Straight
 HTC Straight Series, #6 Cu-954 AAC J-36

CPI Bolted Wedge Hotline Tap Connectors - Angled
 HTC Angled Series, #6-954 ACSR J-37

CPI Bolted Wedge Hotline Bail Connectors
 HTC B Series, #6 Cu-954 AAC J-38

CPI Automatic Splice Connectors
 #6 AAC-556.5 AAC J-39

CPI Bolted Distribution Dead Ends
 #4 AAC-556.5 ACSR J-40

CPI OPGW Bolted Dead Ends
 .354"-.750" J-41
 XL .583"-.871" J-42

CPI Ground Grid Connectors
 .232"-.681" Dia. Range (Vert) / .184"-.575" (Horiz) J-43
 .679"-.813" Dia. Range (Vert) / .368"-.813" (Horiz) J-44

CPI Running Rail Connectors
 Single and Two-Conductor Styles J-45

CPI Contact Rail Connectors
 Single and Two-Conductor Styles J-46

CPI 2000 kcmil Cathode Connector & Cover
 "Pot Head" Connector & Cover J-47

CPI Single Cable Support Spring Rail Clips
 Support for Signal Cables Near Rail J-48

CPI™ Shear Bolt Wedge Tap Connectors #4 - 4/0 Series Aluminum Tap

CPI Aluminum Taps are designed for use as a permanent connection on copper wire or solid rod. CPI wedge connectors use high strength bronze alloy, pure copper and a unique shear head bolt for a mechanically strong, electrically conductive and easy to install connection.

Features and Benefits

- Industry-proven spring wedge technology easily installed with common socket or impact wrench - No Special Tools Required!
- "Spring Like" high strength C-Body ensures permanent connection with consistent pressure on the conductors
- Meets or exceeds current carrying capacity of conductors being connected
- Corrosion resistant highly conductive copper and bronze alloys with a pure copper insert between conductors increases conductivity and lower electrical resistance
- Corrosion inhibitor factory applied for ease of installation
- Remains permanently locked through fault current or power surges
- Easy to remove without damage to conductor
- May be used in non-corrosive environments to connect copper conductors
- Excellent option for emergency restoration where outside crews might not have Shoot-On or compression tooling

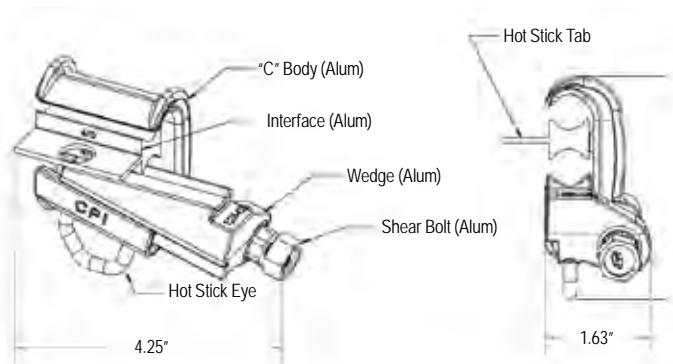

Catalog Number	Conductor			
	Main	Main Dia. Range	Tap	Tap Dia. Range
210104	3/8" guy wire 2/0 AAC	.358" - .418"	#2 Cu	.257" - .292"
640101	#6	.162" - .232"	#6, #4 Sol	.162" - .204"
240100	#4	.232" - .328"	#6, #4 Sol	.162" - .204"
240101	#2		#4	.232" - .257"
240102	#1 AAC		#2, #1 AAC	.292" - .328"
210103	#1 ACSR 1/0 2/0 AAC	.354" - .414"	#6 ACSR, #4 AAC	.198" - .232"
210104			#4, #2 AAC	.257" - .292"
210105			#4 AAC, #2, #1 AAC	.232" - .328"
210106			#1 ACSR, 1/0, 2/0 AAC	.354" - .414"
230107	2/0 ACSR 3/0	.447" - .502"	#6 ACSR, #4 AAC	.198" - .232"
230108			#4, #2 AAC	.232" - .292"
230109			#2 AAC, #1	.292" - .354"
230110			#1 ACSR, 1/0, 2/0 AAC	.354" - .414"
230111			2/0 ACSR, 3/0	.447" - .502"
264111	3/0 ACSR 4/0 250 AAC	.502" - .574"	#6 ACSR, #4 AAC	.198" - .232"
264112			#4 ACSR, #2, #1 AAC	.250" - .328"
264113			#1 ACSR, 1/0, 2/0 AAC	.354" - .414"
264114			2/0 ACSR, 3/0	.447" - .502"
264115			4/0, 250 AAC	.522" - .574"

CPI™ Shear Bolt Wedge Tap Connectors 350 kcmil Series Aluminum Tap

CPI Aluminum Taps are designed for use as a permanent connection on copper wire or solid rod. CPI wedge connectors use high strength bronze alloy, pure copper and a unique shear head bolt for a mechanically strong, electrically conductive and easy to install connection.

Features and Benefits

- Industry-proven spring wedge technology easily installed with common socket or impact wrench - No Special Tools Required!
- “Spring Like” high strength C-Body ensures permanent connection with consistent pressure on the conductors
- Meets or exceeds current carrying capacity of conductors being connected
- Corrosion resistant highly conductive copper and bronze alloys with a pure copper insert between conductors increases conductivity and lower electrical resistance
- Corrosion inhibitor factory applied for ease of installation
- Remains permanently locked through fault current or power surges
- Easy to remove without damage to conductor
- May be used in non-corrosive environments to connect copper conductors
- Excellent option for emergency restoration where outside crews might not have Shoot-On or compression tooling

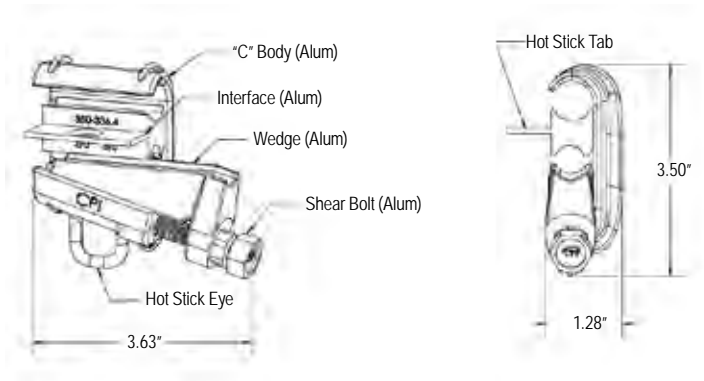

Catalog Number	Conductor			
	Main	Main Dia. Range	Tap	Tap Dia. Range
350117	266.8 ACSR 300 kcmil 336.4 AAC 336.4 ACSR (18/1) 350 kcmil	.609" - .684"	#6, #4 AAC	.162" - .232"
350118			#4	.232" - .257"
350119			#2, #1 AAC	.292" - .328"
350120			#1, 1/0 AAC	.328" - .368"
350121			1/0 ACSR, 2/0	.398" - .447"
350122			2/0 ACSR, 3/0	.447" - .502"
350123			4/0, 250	.522" - .574"
350124			266.8-19 AAC, 300 AAC, 266.8 ACSR	.592" - .642"
350125			300 ACSR 26/7, 350, 336.4 18/1	.665" - .684"

CPI™ Shear Bolt Wedge Tap Connectors 336.4 - 636 kcmil Series Aluminum Tap

CPI Aluminum Taps are designed for use as a permanent connection on copper wire or solid rod. CPI wedge connectors use high strength bronze alloy, pure copper and a unique shear head bolt for a mechanically strong, electrically conductive and easy to install connection.

Features and Benefits

- Industry-proven spring wedge technology easily installed with common socket or impact wrench - No Special Tools Required!
- “Spring Like” high strength C-Body ensures permanent connection with consistent pressure on the conductors
- Meets or exceeds current carrying capacity of conductors being connected
- Corrosion resistant highly conductive copper and bronze alloys with a pure copper insert between conductors increases conductivity and lower electrical resistance
- Corrosion inhibitor factory applied for ease of installation
- Remains permanently locked through fault current or power surges
- Easy to remove without damage to conductor
- May be used in non-corrosive environments to connect copper conductors
- Excellent option for emergency restoration where outside crews might not have Shoot-On or compression tooling

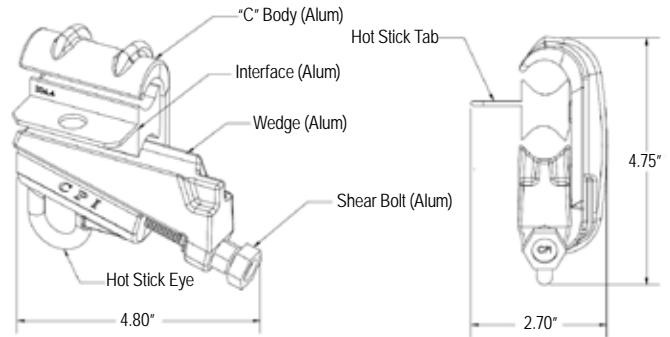

Catalog Number	Conductor			
	Main	Main Dia. Range	Tap	Tap Dia. Range
336222	300 AAC 350 AAC	.63" - .68"	#2 Cu	.257" - .292"
336200	336.4 350 kcmil 397 ACSR 18/1	.666" - .743"	#6, #4	.162" - .257"
336104			#4 ACSR, #2, 1/0 AAC	.257" - .368"
336012			1/0, 2/0, 3/0	.368" - .502"
336866			4/0 ACSR, 266.8 AAC	.522" - .592"
336718			266.8 ACSR 36/7, 336.4, 397.5	.642" - .806"
477057	397 ACSR 24/7 450 kcmil 477 500 kcmil 556.5 AAC	.769" - .858"	#6, #4, #2	.162" - .316"
477962			#2, 1/0	.292" - .398"
477853			1/0 ACSR, 2/0, 3/0 AAC	.398" - .464"
477724			3/0 ACSR, 4/0, 250, 266.8, 300 AAC	.502" - .628"
477633			266.8 ACSR 36/7, 300 AAC, 336.4, 397.5 ACSR 24/7	.628" - .772"
477434			336.4 ACSR 26/7, 397, 477, 500 kcmil, 556 AAC	.720" - .858"
556956			477 ACSR 26/7 556 600 kcmil 636 ACSR 18/1 605 ACSR	.856" - .953"
556892	#2, #1, 1/0	.292" - .398"		
556783	1/0, 2/0, 3/0, 4/0 AAC	.368" - .522"		
556638	4/0, 250, 266.8, 300 kcmil, 336 AAC, 350 kcmil	.522" - .680"		
556504	350 kcmil 336.4, 397.5, 477 AAC	.680" - .806"		
556294	397 ACSR 30/7, 44, 500 kcmil, 556.5, 636 AAC	.795" - .918"		
556294-1	556.5 ACSR 24/7, 636 AAC, 636 ACSR 18/1, 605	.914" - .952"		

CPI™ Shear Bolt Wedge Tap Connectors 795 - 1272 Series Aluminum Tap

CPI Aluminum Taps are designed for use as a permanent connection on copper wire or solid rod. CPI wedge connectors use high strength bronze alloy, pure copper and a unique shear head bolt for a mechanically strong, electrically conductive and easy to install connection.

Features and Benefits

- Industry-proven spring wedge technology easily installed with common socket or impact wrench - No Special Tools Required!
- “Spring Like” high strength C-Body ensures permanent connection with consistent pressure on the conductors
- Meets or exceeds current carrying capacity of conductors being connected
- Corrosion resistant highly conductive copper and bronze alloys with a pure copper insert between conductors increases conductivity and lower electrical resistance
- Corrosion inhibitor factory applied for ease of installation
- Remains permanently locked through fault current or power surges
- Easy to remove without damage to conductor
- May be used in non-corrosive environments to connect copper conductors
- Excellent option for emergency restoration where outside crews might not have Shoot-On or compression tooling

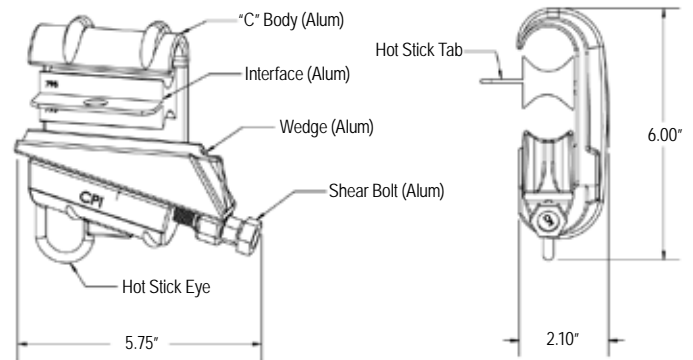
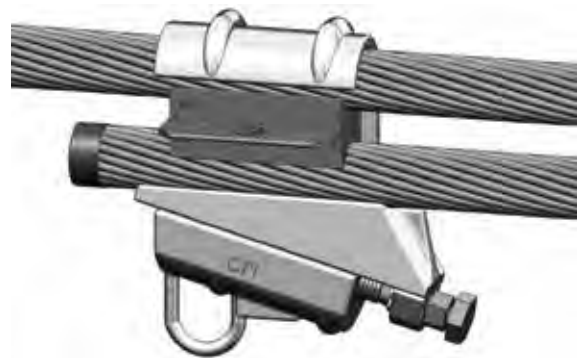

Catalog Number	Conductor					
	Main	Main Dia. Range	Tap	Tap Dia. Range		
795454	636 ACSR 715 750 kcmil 795 900 kcmil	.973" - 1.108"	#6, #4, #2 AAC	.162" - .292"		
795360			#2 ACSR, #1, 1/0, 2/0 AAC	.316" - .414"		
795218			2/0 ACSR, 3/0, 4/0, 250 AAC	.447" - .574"		
795050			266.8, 300 kcmil, 350 kcmil, 336.4 ACSR 18/1	.586" - .684"		
795920			336.4 ACSR 26/7, 450 kcmil, 500 kcmil, 477, 556.5 AAC	.720" - .858"		
795730			477 ACSR 30/7, 556.5 ACSR, 600 kcmil, 605 kcmil, 636 ACSR 18/1, 715.5 AAC	.879" - .975"		
795594			636 ACSR 26/7, 750 kcmil, 715, 795, 900 kcmil	.991" - 1.108"		
954420			954 900 ACSR 1000 kcmil 1113 AAC 1033.5 AAC	1.124" - 1.196"	#6, #4, #2 AAC	.162" - .292"
954320	#2 ACSR, #1, 1/0, 2/0 AAC	.316" - .414"				
954175	2/0 ACSR, 3/0, 4/0, 250 AAC	.447" - .574"				
954030	266.8, 300 kcmil, 350 kcmil, 336.4 ACSR 18/1	.586" - .684"				
954870	336.4 ACSR 26/7, 450 kcmil, 500 kcmil, 477, 556.5 AAC	.720" - .856"				
954660	477 ACSR 26/7, 556, 605, 715 AAC, 636 ACSR 26/7	.858" - .991"				
954484	666.6 ACSR 24/7, 715 ACSR, 795, 900 AAC	1.000" - 1.093"				
954390	795 ACSR 26/7, 954, 1113 kcmil, 900 ACSR, 1000 kcmil, 1033.5 AAC	1.107" - 1.196"				
103370	1-33/5 ACSR 1113 ACSR 1102 AAC 1282 AAC	1.212" - 1.300"			#6, #4, #2 AAC	.162" - .292"
103260					#2 ACSR, #1, 1/0, 2/0 ACSR	.316" - .414"
103110			2/0 ACSR, 3/0, 4/0 AAC	.447" - .522"		
103945			4/0 ACSR, 250 kcmil, 266.8, 300 kcmil	.563" - .642"		
103780			350 kcmil, 336.4, 397.5, 450 kcmil	.665" - .783"		
119793			397.5 ACSR 30/7, 477, 500 kcmil, 556 AAC, 600 kcmil	.795" - .893"		
103680			556.5 ACSR 24/7, 363, 715 ACSR 24/7, 750 kcmil, 795 AAC	.914" - 1.036"		
103580			795 ACSR 36/1, 900, 954 AAC, 1000 AAC, 1113 kcmil	1.040" - 1.151"		
103380			900 ACSR 45/7, 1033.5, 954 ACSR, 1192.5 AAC	1.162" - 1.258"		
119250			1113 ACSR, 1272 AAC	1.212" - 1.300"		

CPI™ Shear Bolt Wedge Tap Connector Selection Chart

Catalog Number	Conductor			
	Main	Main Dia. Range	Tap	Tap Dia. Range
210104	3/8" guy wire 2/0 AAC	.358" - .418"	#2 Cu	.257" - .292"
640101	#6	.162" - .232"	#6 #4 Solid	.162" - .213"
240100	#4 AAC	.232" - .328"	#6 Sol., #4 Solid	.162" - .204"
240101	#4 ACSR		#4, #2 Solid	.232" - .257"
240102	#2 ACSR		#2, #1 AAC	.292" - .328"
210103	#1 ACSR	.354" - .414"	#6 ACSR, #4 AAC	.198" - .232"
210105	1/0 AAC		#4, #2, #1 AAC	.232" - .325"
210106	2/0 AAC		#1 ACSR, 1/0, 2/0 AAC	.355" - .414"
230107	2/0 ACSR 3/0 ACSR	.447" - .502"	#6 ACSR, #4 AAC	.198" - .232"
230108			#4, #2 AAC	.232" - .292"
230109			#2 ACSR, #1	.292" - .354"
230110			1/0, 2/0 AAC	.354" - .414"
230111			2/0, 3/0	.447" - .502"
264111	4/0 AAC 4/0 ACSR 250 kcmil	.502" - .570"	#6 ACSR, #4 AAC	.198" - .232"
264112			#4 ACSR, #2, #1 AAC	.250" - .328"
264113			#1 ACSR, 1/0, 2/0 AAC	.354" - .414"
264114			2/0, 3/0	.447" - .502"
264115			4/0, 250 AAC	.522" - .574"
350117	266.8 ACSR 300 kcmil 336.4 AAC 336.4 ACSR (18/1) 350 kcmil	.609" - .684"	#6 SOL, #4 AAC	.162" - .232"
350118			#4	.232" - .257"
350119			#2, #1 AAC	.276" - .328"
350120			#1, 1/0 AAC	.328" - .382"
350121			1/0 ACSR, 2/0	.398" - .447"
350122			2/0 ACSR, 3/0	.447" - .502"
350123			4/0, 250	.522" - .574"
350124			266.8 -19 AAC, 300 AAC, 266.8 ACSR	.592" - .642"
350125			350, 336.4 (18/1)	.665" - .684"
336222			300 ACC - 350 AAC	.63" - .68"
336200	366 AAC 336 ACSR 350 kcmil 397 ACSR (18/1)	.666" - .743"	#6 SOL, #4	.162" - .257"
336104			#4 ACSR, #2, 1/0 AAC	.257" - .368"
336012			1/0 AAC, 2/0, 3/0	.368" - .502"
336866			4/0 ACSR, 266.8 AAC	.522" - .592"
336718			266.8 ACSR (36/7), 336.4, 397.5	.642" - .806"
477057	450 kcmil 477 AAC 500 kcmil 556.5 AAC	.770" - .858"	#6 SOL, #4, #2	.162" - .316"
477962			#2 AAC, 1/0 ACSR	.292" - .398"
477853			1/0 ACSR, 2/0, 3/0 AAC	.398" - .464"
477724			3/0 ACSR, 4/0, 300 AAC	.502" - .628"
477633			300 AAC, 336.4, 397.5 ACSR (24/7)	.628" - .772"
477434			336.4 ACSR (26/7), 477, 556 AAC (37 str)	.720" - .858"
556956			477 ACSR (26/7) 556 AAC 600 kcmil 556 ACSR (30/7) 636 ACSR (18/1)	.856" - .953"
556892	#2, 1/0	.292" - .398"		
556783	1/0, 2/0, 3/0, 4/0 AAC	.368" - .522"		
556638	4/0, 266.8, 300 kcmil, 336 AAC, 350 kcmil	.522" - .680"		
556504	350 kcmil, 336.4 AAC, 397.5	.680" - .806"		
556294	477, 556.5, 636 AAC (37)	.795" - .918"		
556294-1	556.5 ACSR (24/7), 636 AAC, 605	.914" - .952"		

CPI™ Shear Bolt Wedge Tap Connector Selection Chart (continued)

Catalog Number	Conductor			
	Main	Main Dia. Range	Tap	Tap Dia. Range
795454	715 AAC 750 kcmil 795 AAC 795 ACSR	.973" - 1.108"	#6 SOL, #2 AAC	.162" - .292"
795360			#2 ACSR, 1/0, 2/0 AAC	.316" - .414"
795218			2/0 ACSR, 3/0, 250 AAC	.447" - .574"
795050			266.8 AAC (7 str), 336.4 ACSR (18/1)	.586" - .684"
795920			336.4 ACSR (26/7), 477, 556.5 AAC (37)	.720" - .858"
795730			556.5 ACSR (18/1), 636, 715.5 AAC (61 str)	.879" - .975"
795594			636 ACSR (26/7), 795 ACSR (26/7)	.991" - 1.108"
954420	954 AAC 954 ACSR 1000 kcmil 1033.5 AAC	1.124" - 1.196"	#6 SOL, #2 AAC	.162" - .292"
954320			#2 ACSR (6/1), 1/0, 2/0 AAC	.316" - .414"
954175			2/0 ACSR (6/1), 3/0, 250 AAC (7)	.447" - .574"
954030			266.8 AAC (7 Astr), 366.4 ACSR (18/1)	.586" - .684"
954870			366.4 ACSR (26/7), 397.5, 556.5 AAC (19)	.720" - .856"
954660			477 ACSR (26/7), 636 ACSR (26/7)	.858" - .991"
954484			666.6 ACSR (24/7) 900 AAC (61 str)	1.000" - 1.093"
954390			795 ACSR (26/7), 954 ACSR (54/7)	1.107" - 1.196"
103370	1033.5 AAC (45/7) 1033.5 ACSR 1113 AAC 1113 ACSR 103680 1192 AAC 103580 1272 AAC	1.212" - 1.300"	#6 SOL, #2 AAC	.162" - .292"
103260			#2 ACSR (6/1), 3/0, 250 AAC (7)	.316" - .414"
103110			2/0 ACSR, 3/0, 4/0 AAC	.447" - .522"
103945			4/0 ACSR, 266.8 ACSR (36/7)	.563" - .642"
103780			336.4 AAC, 397.5 ACSR (26/7)	.665" - .783"
119793			477 AAC, 600 kcmil	.795" - .893"
103680			556.5 ACSR (24/7), 715.5 ACSR (24/7)	.914" - 1.036"
103580			795 ACSR (36/1), 795, 900 ACSR (45/7), 1000 AAC	1.040" - 1.151"
103380			900 ACSR (54/7), 1033.5, 954 ACSR (54/7), 1192.5 AAC	1.162" - 1.258"
103580-1			795 ACSR (36/1), 795, 900 ACSR (45/7)	1.040" - 1.151"
119250			1113 ACSR, 1272 AAC (54/19), 1272 AAC (61 str)	1.212" - 1.300"

CPI™ Shear Bolt Wedge Tap Connectors #4 - 350 kcmil Series Copper Tap

CPI Copper Taps are designed for use as a permanent connection on copper wire or solid rod. CPI wedge connectors use high strength bronze alloy, pure copper and a unique shear head bolt for a mechanically strong, electrically conductive and easy to install connection.

Features and Benefits

- Industry-proven spring wedge technology easily installed with common socket or impact wrench
- Installed overhead
- Meets or exceeds current carrying capacity of conductors being connected
- "Spring Like" high strength C-Body ensures permanent connection with consistent pressure on the conductors
- Corrosion resistant highly conductive copper and bronze alloys with a pure copper insert between conductors increases conductivity and lower electrical resistance
- Corrosion inhibitor factory applied for ease of installation
- Remains permanently locked through fault current or power surges
- Easy to remove without damage to conductor

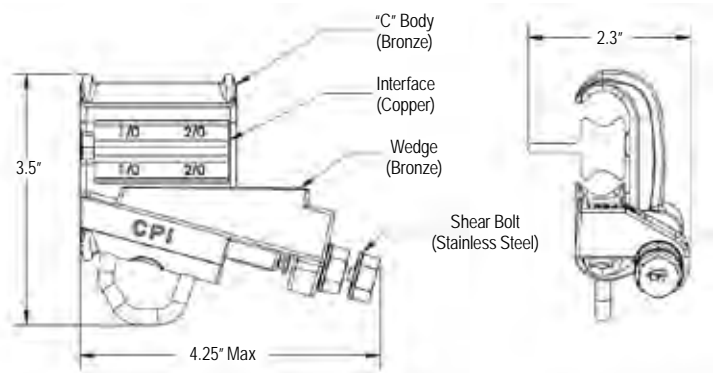

Catalog Number	Copper Conductor			
	Main	Main Dia. Range	Tap	Tap Dia. Range
240100C	#4 - #1 (7 Str)	.232" - .328"	#6-#4 Sol	.162" - .204"
240101C			#4 Str-#2 Sol	.232" - .260"
240102C			#1-#2 Str	.281" - .325"
210103C	1/0 - 2/0	.368" - .419"	#6-#4 Sol	.162" - .204"
210104C			#4 Str-#2 Sol	.232" - .260"
210105C			#1-#2 Str	.281" - .325"
210106C			1/0-2/0	.368" - .419"
230107C	3/0	.464" - .500"	#6-#4 Sol	.162" - .204"
230108C			#4 Str-#2 Sol	.232" - .260"
230109C			#1-#2 Str	.281" - .325"
230110C			1/0-2/0	.368" - .419"
230111C			3/0	.464" - .474"
264110C	4/0	.500" - .530"	#6-#4 Sol	.162" - .204"
264111C			#4 Str-#2 Sol	.232" - .260"
264112C			#1-#2 Str	.281" - .325"
264113C			1/0-2/0	.368" - .419"
264114C			3/0	.464" - .474"
264115C			4/0	.500" - .530"

Catalog Number	Copper Conductor			
	Main	Main Dia. Range	Tap	Tap Dia. Range
350117C	300 - 350	.628" - .679"	#6-#4 Sol	.162" - .204"
350118C			#4 Str-#2 Sol	.232" - .260"
350119C			#1-#2 Str	.281" - .325"
350120C			1/0-2/0	.368" - .414"
350121C			2/0	.414" - .418"
350122C			3/0	.464" - .500"
350123C			4/0-250 kcmil	.522" - .575"
350124C			300 kcmil	.600" - .628"
350125C			350 kcmil	.650" - .679"

CPI™ Tap Cover

Fits Connectors 336.4 through 1272 AAC

CPI Aluminum Tap Covers electrically insulate CPI Shear Bolt Wedge Tap connectors from neighboring connectors on adjacent phases, exposed ground conductors, and nearby grounded structures or vegetation. These covers are intended for casual contact only and are not for use as personal protection. Type applications are 600-Volt maximum insulated-conductor overhead applications.



Features and Benefits

- 600-Volt maximum overhead application rating
- One size fits connectors ranging from 336.4 through 1272 AAC
- Easy one hinge design with self-locking closure
- Louvered side panels for ventilation and ease of installation
- Made from UV-inhibited, injection-molded polypropylene for durability and resistance to cold cracking

Catalog Number: 336100

CPI™ Shear Bolted Wedge Terminals

#6 - 795 AAC Expanded Range Taking; Fit 2-hole NEMA pads

CPI Aluminum Bolted Wedge Terminals feature 2-hole NEMA pad with aluminum shear bolt with no interface required. Only 4 sizes cover #6 through 795 AAC.

Features and Benefits

- No interface required
- Simplified installation, no special tools required
- Expanded range-taking design, only 4 sizes needed to cover from #6 through 795 AAC
- Fits 2-hole NEMA pad
- Easily removable

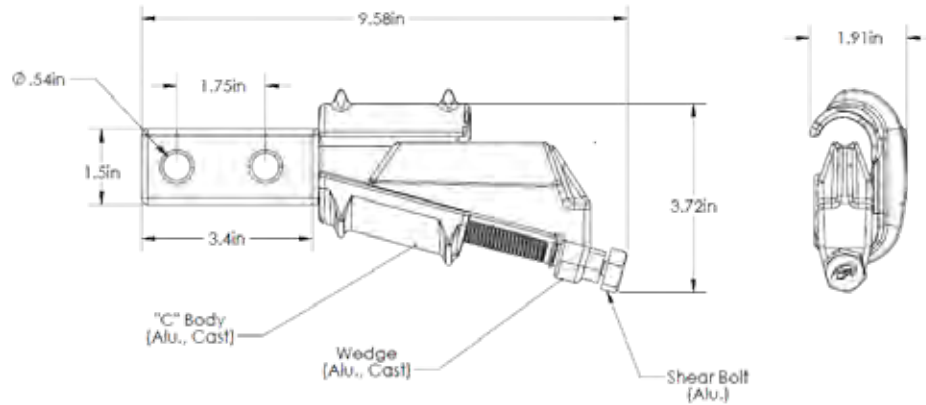

Catalog Number	Conductor		Dimensions		
	Nominal Wire Range	Wire Diameter	L	W	H
TP100	#6 - 2/0 AAC	.162" - .414"	9.58"	1.91"	3.72"
TP200	2/0 AAC - 336.4 AAC	.414" - .656"			
TP300	336.4 AAC - 636 AAC	.656" - .918"			
TP400	636 AAC - 795 AAC	.918" - 1.027"			

CPI™ Shear Bolt Wedge Stirrups

Accommodates #6 - 4/0 ACSR; Available with 1/0 or 2/0 Bail

CPI Bolted Wedge Stirrups require no loose interface for connection and an expanded wire range reduces the total number of SKUs from four to one compared with standard product. Available with a 1/0 or 2/0 tin plated copper bail for easy connection with a bronze hot line clamp. Mainly used in utility overhead distribution primary line tapping used with standard bronze hot line clamps (sold separately).

Features and Benefits

- No loose interface required for connection
- Simplified installation, no special tools required
- Expanded range-taking design, only 1 size covers from #6 solid through 4/0 ACSR
- Aluminum shear bolt guarantees proper torque without the need of a torque wrench
- Aluminum triple lead threads reduces the number of turns to install the connector
- Connector is easily removable with a standard wrench

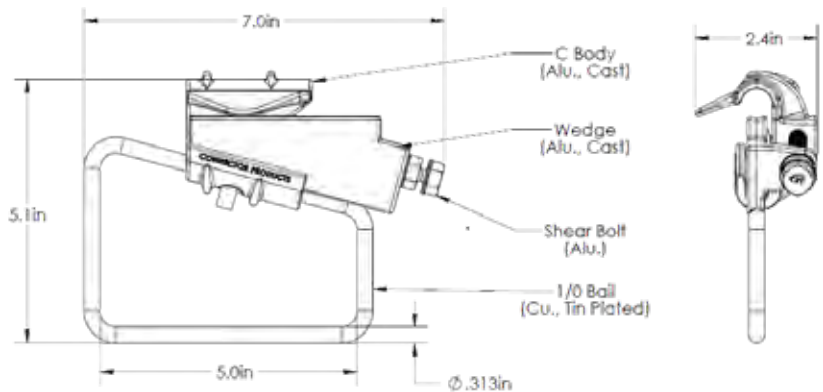

Catalog Number	Nominal Wire Range	Wire Diameter	Bail Size	Dimensions		
				L	W	H
120000	#6 Sol - 4/0 ACSR	.162" - .574"	1/0 Bail	7.0	2.4	5.1
120100			2/0 Bail	6.8	2.4	5.2

CPI™ Shear Bolt Wedge Stirrups, Aluminum

Accommodates #4 - 397.5 AAC

CPI Aluminum Stirrup Connectors are designed for connecting to aluminum or copper conductors. Stirrups are intended to protect the main line conductor from damage and arcing as hot line clamps are connected and disconnected. During installation, when proper spring tension and torque is achieved, the shear head bolt will break off giving the install a positive indication of a corrected completed connection.

Features and Benefits

- Easy to remove and re-use without damaging the conductor
- Heavy duty tin plated bail has a large loop to allow for multiple connection positions while also eliminating galvanic reaction
- Easy to install with standard socket or impact wrench, requires no special tools
- Easy adaptable to standard hot stick tools
- High-conductivity grit corrosion inhibitor is factory applied for ease of installation and longevity while the connector is in service
- Remains permanently locked through fault current or power surges
- May be used in non-corrosive environments to connect copper conductors
- Excellent option for emergency restoration where outside crews might not have shoot-on or compression tooling

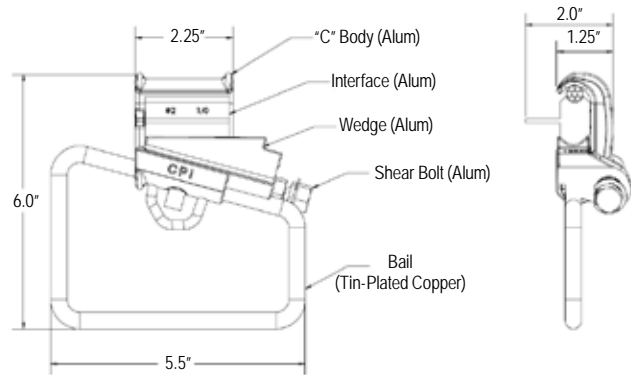

Catalog Number	Conductor			
	Main	Main Dia. Range	Bail Size	Ampacity
102011-2	#6, #4, #2 AAC	.162" - .292"	#2	400
102011			1/0	550
102011-3			2/0	700
102011-4			4/0	850
102010-2	#2, #1, 1/0	.292" - .398"	#2	400
102010			1/0	550
102010-3			2/0	700
102040			4/0	850
102009-2	2/0, 3/0, 4/0 AAC	.414" - .522"	#2	400
102009			1/0	550
102009-3			2/0	700
102009-4			4/0	850
264124-2	3/0 ACSR, 250, 4/0	.502" - .574"	#2	400
264124			1/0	550
264124-3			2/0	700
264424			4/0	850
336915-2	226.8, 300, 336.4, 397.5 AAC	.586" - .724"	#2	400
336915-1			1/0	550
336915-3			2/0	700
336915-4			4/0	850

CPI™ Shear Bolt Wedge Stirrups, Aluminum

Accommodates 226.8 ACSR 30/7 - 1272 AAC

CPI Aluminum Stirrup Connectors are designed for connecting to aluminum or copper conductors. Stirrups are intended to protect the main line conductor from damage and arcing as hot line clamps are connected and disconnected. During installation, when proper spring tension and torque is achieved, the shear head bolt will break off giving the install a positive indication of a corrected completed connection.

Features and Benefits

- Easy to remove and re-use without damaging the conductor
- Heavy duty tin plated bail has a large loop to allow for multiple connection positions while also eliminating galvanic reaction
- Easy to install with standard socket or impact wrench, requires no special tools
- Easy adaptable to standard hot stick tools
- High-conductivity grit corrosion inhibitor is factory applied for ease of installation and longevity while the connector is in service
- Remains permanently locked through fault current or power surges
- May be used in non-corrosive environments to connect copper conductors
- Excellent option for emergency restoration where outside crews might not have shoot-on or compression tooling

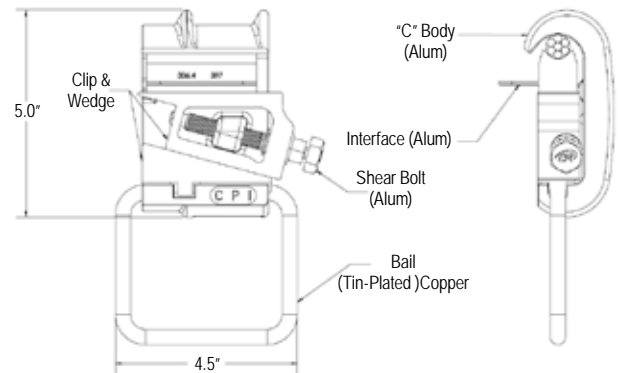

Catalog Number	Conductor			
	Main	Main Dia. Range	Bail Size	Ampacity
336781	226.8 ACSR 30/7,	.642" - .743"	1/0	550
336875	336.4, 397.5 AAC,		2/0	700
336780	397.5 ACSR 18/1		4/0	850
556581	450, 397.5 ACSR, 477,	.769" - .883"	1/0	550
556580	500, 556.5 AAC,		2/0	700
556595	556.5 ACSR 18/1		4/0	850
636551	477 ACSR 26/7, 30/7,	.856" - .991"	1/0	550
636556	556.6, 600, 636, 605,		2/0	700
636556-1	715 AAC		4/0	850
795501	636 ACSR, 750, 666.6, 715, 795, 900	.990" - 1.108"	1/0	550
795500			2/0	700
795405			4/0	850
103228	715.5 ACSR, 795	1.036" - 1.162"	2/0	700
103228-1	ACSR, 900, 954, 1113 AAC, 1000		4/0	850
119375	954, 1113, 900 ACSR,	1.124" - 1.302"	2/0	700
119375-1	1033.5, 1113, 1272 AAC		4/0	850

CPI™ Shear Bolt Wedge Stirrups, Copper

Accommodates #6 - 350 kcmil

CPI Copper Stirrup Connectors are designed for connecting to copper conductors. Stirrups are intended to protect the main line conductor from damage and arcing as hot line clamps are connected and disconnected. During installation, when proper spring tension and torque is achieved, the shear head bolt will break off giving the install a positive indication of a corrected completed connection.

Features and Benefits

- Easy to remove and re-use without damaging the conductor
- Heavy duty tin plated bail has a large loop to allow for multiple connection positions while also eliminating galvanic reaction
- Easy to install with standard socket or impact wrench, requires no special tools
- Easy adaptable to standard hot stick tools
- Remains permanently locked through fault current or power surges
- Excellent option for emergency restoration where outside crews might not have shoot-on or compression tooling

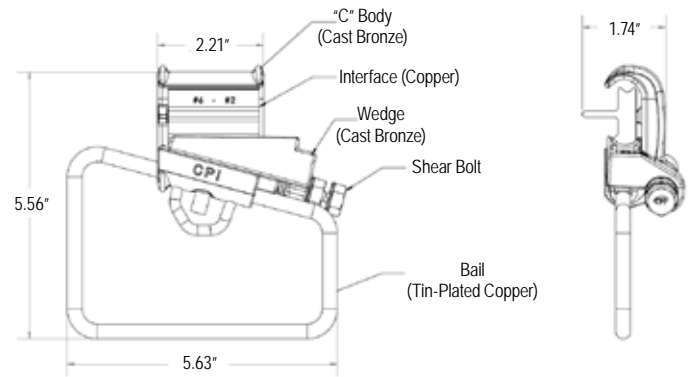

Catalog Number	Conductor			
	Main	Main Dia. Range	Bail Size	Ampacity
102012-2C	#6 Cu - #4 Cu	.162" - .232"	#2	400
102012C			1/0	550
102012-3C			2/0	700
102012-4C			4/0	850
102011-2C	#4 Cu - #2 Cu	.232" - .292"	#2	400
102011C			1/0	550
102011-3C			2/0	700
102011-4C			4/0	850
102010-2C	#2 Cu - 1/0 Cu	.292" - .368"	#2	400
102010C			1/0	550
102010-3C			2/0	700
102040C			4/0	850
102009-2C	2/0 Cu 7 Str - 4/0 Cu	.414" - .528"	#2	400
102009C			1/0	550
102009-3C			2/0	700
102009-4C			4/0	850
264124-2C	4/0 Cu 7 Str - 250 Cu 19 Str	.522" - .574"	#2	400
264124C			1/0	550
264124-3C			2/0	700
264424C			4/0	850
336915-2C	250 Cu - 350 Cu	.574" - .679"	#2	400
336915-1C			1/0	550
336915-3C			2/0	700
336915-4C			4/0	850

CPI™ Cast Paddle Stirrups

Available in Bronze, or Tin-Plated Bronze

CPI Paddle Stirrups are designed to easily attach hot line clamps or grounding clamps onto various system components. Stirrups are used to protect the main conductor as hot line or grounding clamps are installed and removed. Typical applications are to connect hot line taps, lightning arrestors, re-closer connections and pigtails.

Special applications can include installation on equipment such as cut-outs, riser pole disconnect switches and pad-mounted switch gear for safe grounding and maintenance purposes.

Features and Benefits

- CPI Paddle Stirrups are available in longer lengths than traditional versions allowing for multiple connection points on one unit
- Multiple lengths available, contact the factory for availability
- Slotted holes allow connection to terminals or spaces with standard NEMA spacing

Catalog Number	Material	Handle Length
802525	Bronze	5.25"
802525T	Tin-Plated Bronze	
802526	Bronze	3.25"
802526T	Tin-Plated Bronze	

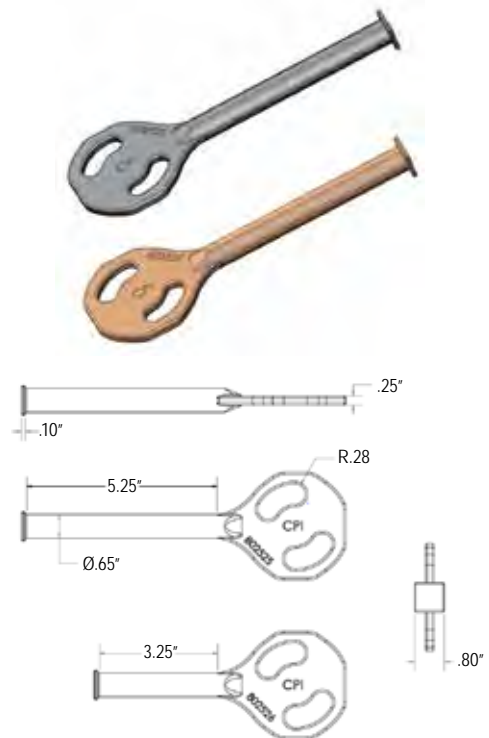

CPI™ Cast Paddle Stirrups

Bi-Metallic Construction

CPI Bi-Metallic Paddle Stirrups are designed to easily attach hot line clamps or grounding clamps onto various system components. Stirrups are used to protect the main conductor as hot line or grounding clamps are installed and removed. Typical applications are to connect hot line taps, lightning arrestors, re-closer connections and pigtails. Special applications can include installation on equipment such as cut-outs, riser pole disconnect switches and pad-mounted switch gear for safe grounding and maintenance purposes.

Bi-Metallic construction allows connection between aluminum system components and bronze hot line clamps while preventing galvanic reaction.

Features and Benefits

- Bi-Metallic construction allows connection between aluminum system components and bronze hot line clamps while preventing galvanic reaction
- The stirrup is fault current rated at 10K amps for a 2-second duration
- Standard or slotted hole configuration allows connection to terminals or spades with standard NEMA spacing
- Fully CNC machined from EC grade aluminum and pure 110% copper for maximum conductivity
- Copper rod is tin-plated and coated with corrosion inhibitor before it is threaded and crimped into the aluminum body

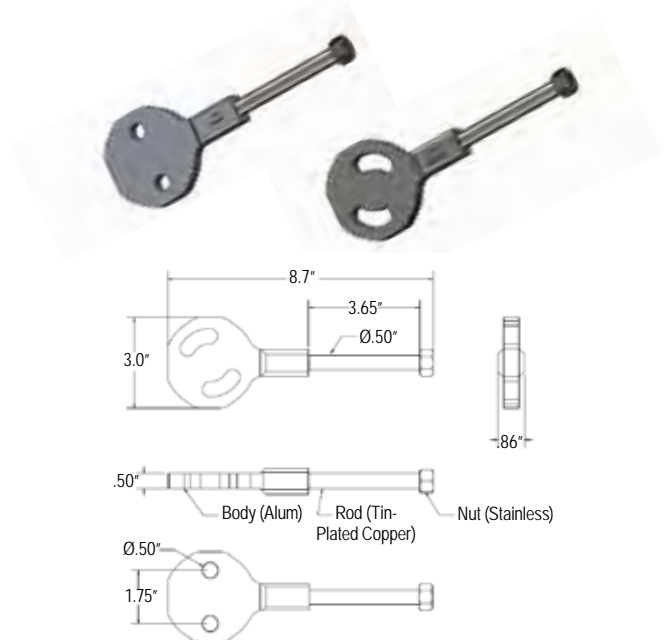

Catalog Number	Material	Pad Configuration	Handle Length
801450	Bi-Metallic	Standard	3.65"
801450S		Slotted	

CPI™ Shear Bolt Wedge Pad Tap Connectors

Accommodates #2 - 1590 AAC 61

CPI Aluminum Pad Tap Connectors connect aluminum or copper conductor to a variety of 2- or 4-hole NEMA devices. Perfect for use in mounting sectionalizing switches, to connect compression lugs for risers or many different uses in substations. Pad Tap Connectors are extremely beneficial in applications that may need to be disconnected.

Features and Benefits

- Easy to remove and re-use without damaging the conductor
- Available in NEMA standard 2- or 4-hole patterns
- Industry-proven wedge technology for quick and easy installation without the need for special tools
- Easily adaptable to standard hotstick tools
- High-conductivity grit corrosion inhibitor is factory applied for ease of installation and longevity while the connector is in service
- Meets or exceeds the current carrying capacity of the conductors being connected
- Remains permanently locked through fault current or power surges
- May be used in non-corrosive environments to connect copper conductors
- Excellent option for emergency restoration applications where outside crews might not have shoot-on or compression tooling

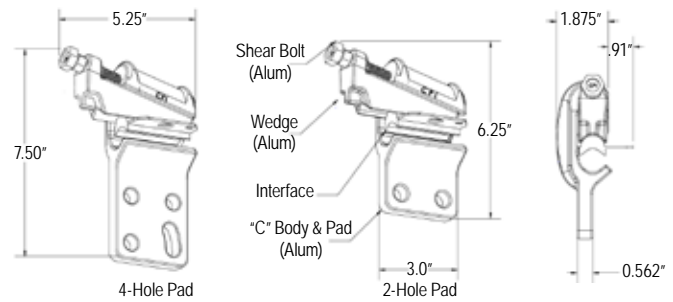

Catalog Number	Pad Hole Configuration	Conductor	
		Main	Main Dia. Range
723210	4 Hole	#2, 1/0, 2/0 AAC	.292" - .414"
723210-1	2 Hole		
723003	4 Hole	1/0, 2/0, 3/0, 4/0 AAC	.368" - .522"
723003-1	2 Hole		
723004	4 Hole	4/0, 250, 266.8, 300, 350, 336.4 AAC, 336.4 ACSR 18/1 & 26/7	.522" - .720"
723004-1	2 Hole		
723005	4 Hole	336.4 ACSR 30/7, 397.5, 450, 477, 500, 556.5 AAC, 556.5 ACSR 18/1 & 24/7, 636 AAC	.720" - .918"
723005-1	2 Hole		
723006	4 Hole	556.5 ACSR 26 & 30/7, 605, 715, 750, 636, 666.6, 795, 900, 954 AAC	.918" - 1.125"
723006-1	2 Hole		
723007	4 Hole	954, 1000 kcmil, 1033 AAC	1.125" - 1.196"
723007-1	2 Hole		
723008	4 Hole	1033 ACSR, 1192 AAC, 1272 AAC	1.216" - 1.302"
723008-1	2 Hole		
723009	4 Hole	1590 AAC 61	1.454"
723009-1	2 Hole		

CPI™ Piggy-Back Clamp

#8 - 653.9 ACSR

CPI Aluminum Piggy-Back Clamps are designed to temporarily hold the tap conductor in position with the main conductor while a permanent connection is made elsewhere. This versatile temporary clamp assist the Lineman with with the installation of many types of tap connectors, especially in Hot-Stick applications.

Features and Benefits

- Easy to remove and re-use without damaging the conductor
- Main Line can be held in either jaw
- **Temporary Connection Only**, not intended as a permanent connector
- Accommodates wire sizes #8 - 653.9 ACSR
- Aluminum body with stainless steel eye bolt

Catalog Number	For connectors that accommodate wires
	Nominal Wire Range
6002248	#8 - 653.9 ACSR

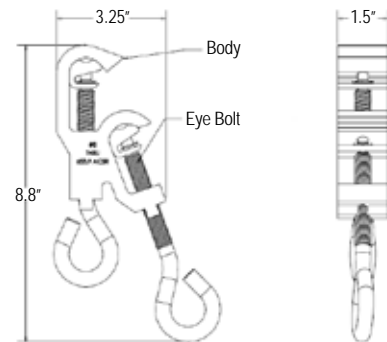

CPI™ Hotline Tap Connectors

HTC Straight Series; #6 Cu - 954 AAC

CPI Hotline Tap Connectors, HTC Straight Series, are designed for use as a permanent or temporary connection on aluminum or copper wire. Featuring the wedge principal, the HTC Series tap connectors maximize connecting force on the conductor with a self-maintaining spring wedge connection.

The elastic spring connecting force created by the connector ensure the HTC connector will stay tight during service by overcoming issues with heat cycling.



Features and Benefits

- Full-current rated connector for use as an in-line jumper or a device tap
- Increased conductive path and surface contact area between the main and tap line increases current ampacity rating
- Can be installed directly to the main with no need for bail or stirrup
- Stainless steel eye bolt increases strength and corrosion resistance
- High-conductivity grit type corrosion inhibitor is factory applied for ease of installation and longevity while connector is in service
- Remains permanently locked through fault current or power surges
- Horizontal wedge action prevents the conductor from "sticking" during the removal process
- Easy to remove without damaging cable

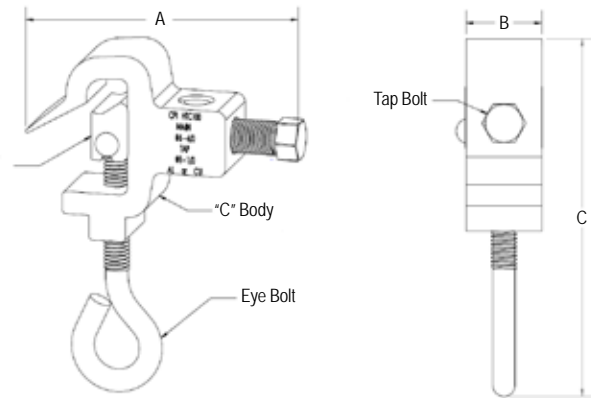

Catalog Number	Conductor				Dimensions		
	Main	Main Dia. Range	Tap	Tap Dia. Range	A	B	C
HTC100	#6 Cu - 4/0	.162" - .563"	#8 - 1/0	.128" - .398"	3.5"	1.125"	5.0"
HTC100-4			#8 - 4/0	.128" - .563"			
HTC200	2/0 - 556.5 AAC	.414" - .858"	#8 - 2/0	.128" - .447"	4.14"	1.5"	6.5"
HTC200-4			#8 - 4/0	.128" - .563"			
HTC300	4/0 - 954 AAC	.522" - 1.125"	#8 - 4/0	.128" - .563"	5.125"	1.75"	7.5"

Available options:

- Add suffix "R" to add full radius edges for transmission applications
- Add suffix "E" to replace tap bolt with 1/2" eyebolt
- Add suffix "T" for Tin Plating

CPI™ Bolted Wedge Hotline Tap Connectors HTC Angled Series; #6 - 954 ACSR

CPI Hotline Tap Connectors, HTC Angled Series, are designed for use as a permanent or temporary connection on aluminum or copper wire. Featuring the wedge principal, the HTC Series tap connectors maximize connecting force on the conductor with a self-maintaining spring wedge connection. Angled tap side allows extra clearance of the tap conductor when using a shotgun stick.

Features and Benefits

- Angled tap side allows extra clearance of the tap conductor when using a shotgun stick
- Full-current rated connector for use as an in-line jumper or a device tap
- Increased conductive path and surface contact area between the main and tap line increases current ampacity rating
- Can be installed directly to the main with no need for bail or stirrup
- Stainless steel eye bolt increases strength and corrosion resistance
- High-conductivity grit type corrosion inhibitor is factory applied for ease of installation and longevity while connector is in service
- Remains permanently locked through fault current or power surges
- Horizontal wedge action prevents the conductor from "sticking" during the removal process
- Easy to remove without damaging cable

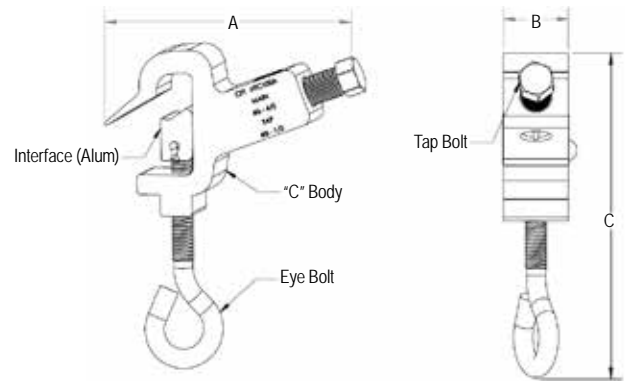

Catalog Number	Conductor				Dimensions		
	Main	Main Dia. Range	Tap	Tap Dia. Range	A	B	C
HTC100A	#6 - 4/0	.162" - .563"	#8 - 1/0	.128" - .398"	4.4"	1.125"	5.85"
HTC100-4A			#8 - 4/0	.128" - .563"			
HTC200A	2/0 - 556.5 AAC	.414" - .858"	#8 - 2/0	.128" - .447"	5"	1.5"	8"
HTC200-4A			#8 - 4/0	.128" - .563"			
HTC212A	#6 - 636 AAC	.162" - .905"	#8 - 266.8 AAC	.128" - .593"	7"	1.75"	8.8"
HTC300A	4/0 - 954 AAC	.522" - 1.125"	#8 - 4/0	.128" - .563"			
HTC350A	477 AAC - 954 ACSR	.792" - 1.196"	#8 - 4/0	.128" - .563"			

Available options:

- Add suffix "E" to replace tap bolt with 1/2" eyebolt
- Add suffix "T" for Tin Plating

CPI™ Hotline Tap Bail Connectors HTC B Series; #6 Cu - 954 AAC

CPI Hotline Tap Bail Connectors (HTC B Series), are designed for connecting to aluminum or copper conductors. Stirrups are intended to protect the main line conductor from damage and arcing as Hot Line Clamps are connected and disconnected.

Features and Benefits

- Incorporates stainless steel eye bolt for increased strength and corrosion resistance
- Copper bail is Tin Plated to prevent galvanic reaction between dissimilar metals
- The bail is locked into the connector using threaded set screws preventing excessive deformation while maximizing surface contact area for maximum conductivity
- High conductivity grit type corrosion inhibitor is factory applied for ease of installation and longevity while the connector is in service
- Remains permanently locked through fault current or power surges
- Horizontal wedge action prevents the conductor from "sticking" during the removal process
- Easy to remove without damaging cables

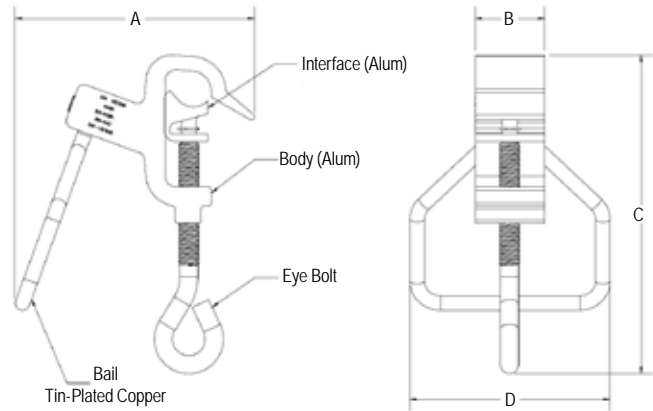

Catalog Number	Conductor				Dimensions			
	Main	Main Dia. Range	Bail Size	Ampacity	A	B	C	D
HTC10B	#6 Cu - 4/0	.162" - .563"	#2	400	4"	1.125"	5.5"	3.75"
HTC11B			#1	465				
HTC20B	1/0 - 556.5 AAC	.398" - .858"	1/0	550	5"	1.5"	6.5"	4.312"
HTC30B	4/0 - 954 AAC	.522" - 1.125"	1/0	550	5.375"	1.75	7.25"	4.312"
HTC32B			2/0	640				

CPI™ Automatic Splice Connectors

Accommodates #6 AAC - 556.5 AAC

CPI Automatic Splice Connectors are designed as a permanent or temporary connection on AAC, ACSR, or AAAC conductor in full or partial tension applications. The unique open design helps overcome the two most common reasons for splice failure: improper installation and corrosion. The window allows the installer to see when the wire is fully inserted properly and prevents water and other contamination from building up inside the connector.

The splice is made of the finest aluminum alloys for optimal conductivity and corrosion resistance.

Features and Benefits

- Only automatic splice available where you can see that the wire is fully inserted and installed properly
- No need to mark and measure the depth of cable insertion
- Open design helps prevent corrosion by allowing water and contamination to drain
- Stainless steel springs resist corrosion
- Tested to ANSI C119.4 specification*
- Minimum 5% tension needed to maintain electrical connection
- Positive center stop for conductor
- Minimal distance lost when sagging conductor
- Chamfered wedge aids cable insertion
- 4:1 surface area vs. cable for optimal conductivity
- Slider handle allows the splice to be released if needed
- Individually packaged in sealed plastic bags to prevent contamination before use

*Contact BURNDY Product Management for product performance data

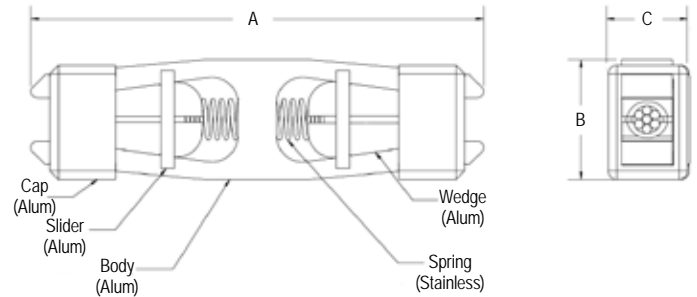

Catalog Number	Conductor		Dimensions		
	Main	Main Dia. Range	A	B	C
S500	#6 AAC/ACSR/AAAC #4 AAC/ACSR/AAAC	.184" - .257"	6.500"	1.75"	1.25"
S750	#4 ACSR/AAC/AAAC #2AAC/ACSR/AAAC	.250" - .316"			
S1000	#2 AAC/ACSR/AAAC 1/0 AAC/ACSR/AAAC 2/0 AAC	.292" - .414"			
S1500	2/0	.414" - .447"	.8.625"	2.44"	1.50"
S2000	3/0 AAC/ACSR/AAAC 4/0 AAC/ACSR/AAAC 266.8 AAC	.464" - .586"			
S3000	266.8 ACSR/AAAC 336.4 AAC/ACSR 18/1 AAAC 397.5 AAC/ACSR 18/1	.609" - .743"	12.375"	3.00"	1.94"
S4000	397.5 ACSR 18/1 477 ACSR 26/7 556.5 AAC	.743" - .858"	11.000"	3.00"	1.75"

CPI™ Bolted Distribution Dead Ends

Accommodates #4 AAC - 556.5 ACSR

CPI Bolted Distribution Dead Ends are used for distribution or transmission construction to terminate on ACSR, AAC, or AAAC conductors. Unlike traditional U-bolt style units, the CPI Dead End features independent bolts that can be fully tightened without having to alternate between bolts. This prevents the possibility of casting breakage due to offset U-bolt over-tightening. Optional torque control shear-head bolts prevent over-tightening that is common with today's impact wrenches.

Features and Benefits

- Body is made of heat-treated aluminum alloy
- Captive stainless steel hardware provided
- Pulling eye rated to 6,000 pounds included in assembly
- Side loading for ease of installation
- Spring-loaded design maintains clearance of conductors during installation
- Unique independent bolts prevents casting breakage by allowing full tightening without having to alternate; this time saving feature also eliminates any lineman confusion
- Optional torque control shear-head nuts available



Figure 1



Figure 2

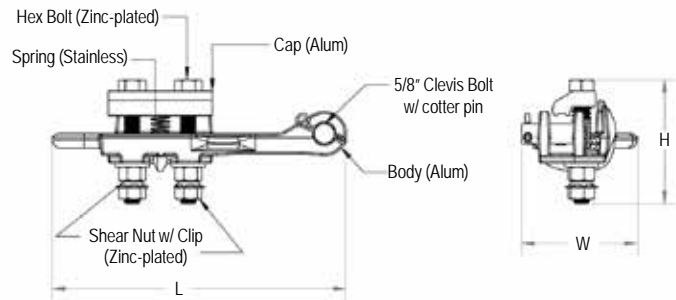

Catalog Number	Figure	Conductor		Dimensions			Ultimate Strength (lbs)	
		Main	Main Dia. Range	L	W	H	Body	Pulling Eye
SBDE410	1	#4 AAC - 1/0 AAC	.232" - .368"	9.25"	3.30"	4.00"	10,000	5,500
SBDE440	1	#4 AAC - 4/0 ACSR	.232" - .563"	9.25"	3.30"	4.00"	10,000	5,500
SBDE556.5-2	2	3/0 ACSR - 556.5 ACSR	.502" - .888"	14.75"	3.55"	4.25"	12,500	8,500

Available options:

- Add suffix "S" for Shear Nuts
- Add suffix "T" for Tin Plating

Example: SBDE556.5-2S

CPI™ OPGW Bolted Dead Ends

Accommodates .354" - .750"

CPI Optical Grounding Wire Spans (OPGW) Bolted Dead Ends are designed as a full tension termination. The patented Left and Right Hand gripper design allows the dead end to hold 95% of the cable's RBS (Rated Breaking Strength). Break-Away shear head bolts are used to ensure the proper gripping force is applied to the cable without attenuating the fibers and optical performance.

Please provide cable specification sheet when ordering.

Features and Benefits

- Rubber grommets suppress Aeolian vibration fatigue at the cable exit point
- Compact length allows for complete installation from the structure
- Shear Head bolts ensure proper torquing necessary to achieve maximum holding strength without damaging the fibers
- Optional Cable Down Guide helps to train the cable down or around the structure without exceeding the minimum bend radius of the cable
- Shorter and easier to install than formed wire dead ends allowing installation directly from the tower
- Standard drilled and tapped grounding lug attachment point eliminates the need for additional bonding accessories
- Unique cable gripper insert system greatly reduces manufacturing lead times
 - most sizes are typically available in stock directly from the factory
- Design Criteria:
 - Sustained load, 95% of cable RBS
 - Ultimate Mechanical Strength 35,000 lbs
 - Cable Diameter Range .350" - .750"
- Dead ends for larger cable may be available, please contact the factory

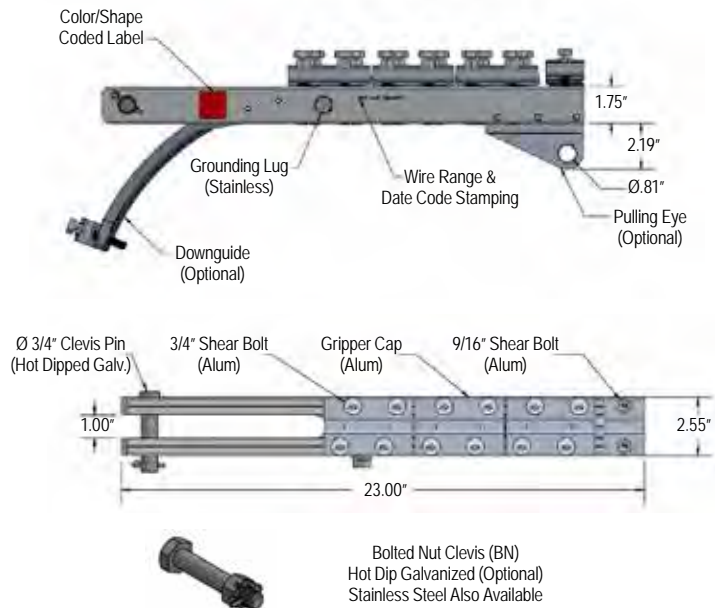

Catalog Number	Dia. Range (mm)		Dia. Range (in)		Label (per wire size)	
	Min	Max	Min	Max	Color	Shape
OBDE8.98-9.75	8.98	9.75	0.354	0.384	White	Circle
OBDE9.75-10.7	9.75	10.7	0.384	0.422	Teal	S
OBDE10.7-11.5	10.7	11.5	0.422	0.453	Light Green	Heart
OBDE11.5-12.7	11.5	12.7	0.453	0.500	Dark Green	Triangle
OBDE12.7-13.7	12.7	13.7	0.500	0.540	Yellow	X
OBDE13.7-14.3	13.7	14.3	0.540	0.563	Black	#
OBDE14.3-14.8	14.3	14.8	0.563	0.583	Red	Square
OBDE14.8-15.5	14.8	15.5	0.583	0.611	Dark Blue	D
OBDE15.5-16.2	15.5	16.2	0.611	0.638	Orange	A
OBDE16.2-17.0	16.2	17.0	0.638	0.670	Brown	M
OBDE17.0-17.9	17.0	17.9	0.670	0.705	Pink	Star
OBDE17.9-19.0	17.9	19.0	0.705	0.750	Grey	P

Available options:

- Add suffix "DG" for the Downguide Option
- Add suffix "BN" for the Bolt Nut Clevis Option
- Add suffix "PE" for Pulling Eye Option

CPI™ XL OPGW Bolted Dead Ends

Accommodates .583" - .871"

CPI Extra Large (XL) Optical Grounding Wire Spans (OPGW) Bolted Dead Ends are designed as a full tension termination. The patented Left and Right Hand gripper design allows the dead end to hold 95% of the cable's RBS (Rated Breaking Strength). Break-Away shear head bolts are used to ensure the proper gripping force is applied to the cable without attenuating the fibers and optical performance.

Please provide cable specification sheet when ordering.

Features and Benefits

- Compact length allows for complete installation from the structure
- Shear Head bolts ensure proper torquing necessary to achieve maximum holding strength without damaging the fibers
- Shorter and easier to install than formed wire dead ends allowing installation directly from the tower
- Design Criteria:
 - Sustained load, 95% of cable RBS
 - Ultimate Mechanical Strength 60,000 lbs
 - Cable Diameter Range .625" - 1.125" overall diameter
- Must be used in conjunction with the CPI Grounding Jumpers
- All OBDE-XL Bolted Dead Ends are supplied with a clevis bolt, hex nut, and cotter pin

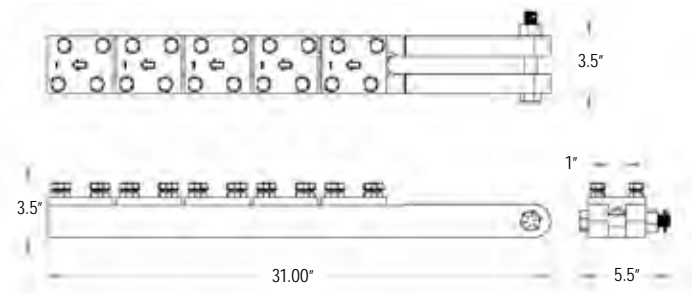
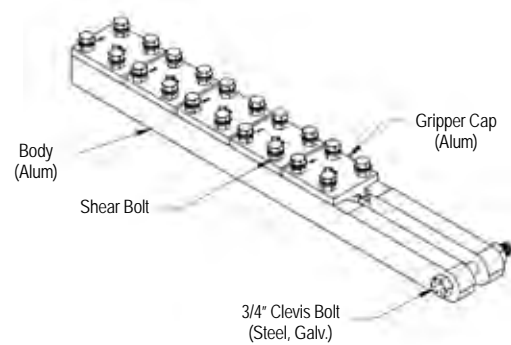

Catalog Number	Dia. Range (mm)		Dia. Range (in)	
	Min	Max	Min	Max
OBDE-XL-14.8-15.5	14.8	15.5	0.583	0.611
OBDE-XL-15.5-16.2	15.5	16.2	0.611	0.638
OBDE-XL-16.2-17.0	16.2	17.0	0.638	0.670
OBDE-XL-17.0-17.9	17.0	17.9	0.670	0.705
OBDE-XL-17.9-19.0	17.9	19.0	0.705	0.749
OBDE-XL-19.0-21.1	19.0	21.1	0.749	0.831
OBDE-XL-21.1-22.1	21.1	22.1	0.831	0.871

CPI™ Ground Grid Connectors

Accommodates .232" - .681" Diameter Range (Vertical)

.184" - .575" Diameter Range (Horizontal)

CPI Ground Grid Connectors are a safe, fast, and dependable method of making permanent wire-to-wire and wire-to-rod connections for a variety of grounding applications. Using a special shear-head bolt to drive a wedge into the connector activates the connector. When the proper torque and spring tension is achieved, the bolt head shears off, giving the installer a positive indication of an optimum connection.

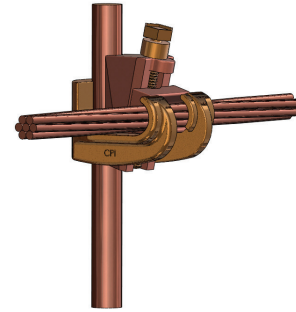

Features and Benefits

- No special molds, chemicals, tools, dies or fired-on charges necessary for installation; installed with a common socket, impact or ratchet wrench
- No temperature or weather restrictions for installation; can be installed no matter what environment exists at the job site
- Shear-head bolt ensures consistency of application and positive verification of a completed connection
- Typical applications:
 - Substation ground grids
 - Pole grounds transmission line grounding
 - Industrial/Residential service grounds
 - Pad Mount Transformers
 - Telco distribution / CATV grounds
 - Wind Farms

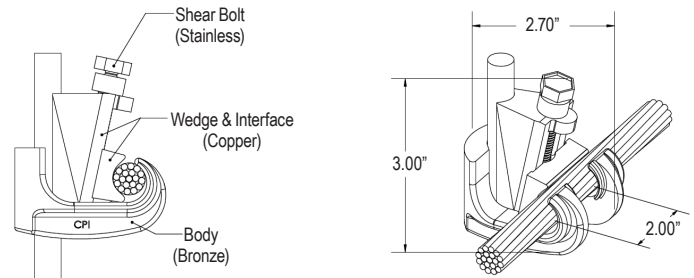

Catalog Number	Conductor			
	Vertical	Vertical Dia. Range	Horizontal	Horizontal Dia. Range
900100	350 kcmil - 3/4" Rod 300 kcmil	.681" - .680" .630"	250 kcmil - 5/8" Rod 4/0 Str	.575" - .556" .522"
	250 kcmil	.575"	250 kcmil	.575"
900101	250 kcmil - 4/0 Str	.575" - .522"	250 kcmil - 5/8" Rod 4/0 Str	.575" - .556" .522"
	250 kcmil	.575"	1/2" Rod	.368"
900102	250 kcmil - 5/8" Rod 4/0 Str	.575" - .556" .522"	2/0 kcmil - 1/0 Str	.419" - .368"
	1/2" Rod	.472"		.368"
900103	2/0 Str - 1/0 Str	.419" - .368"	2/0 Str - 1/0 Str	.419" - .368"
	5/8" Rod - 1/2" Rod 4/0 Str	.556" - .472" .522"	#2 Str	.292"
900104	250 kcmil - 4/0 Str #1 Str	.575" - .522" .328"	#4 Str - #6 Str #1 Str	.232" - .184" .328"
900105	#4 Str = #2 Str	.232" - .282"	#4 Str - #2 Str	.232" - .282"

CPI™ Ground Grid Connectors

Accommodates .679" - .813" Diameter Range (Vertical)

.368" - .813" Diameter Range (Horizontal)

CPI Ground Grid Connectors are a safe, fast, and dependable method of making permanent wire-to-wire and wire-to-rod connections for a variety of grounding applications. Using a special shear-head bolt to drive a wedge into the connector activates the connector. When the proper torque and spring tension is achieved, the bolt head shears off, giving the installer a positive indication of an optimum connection.

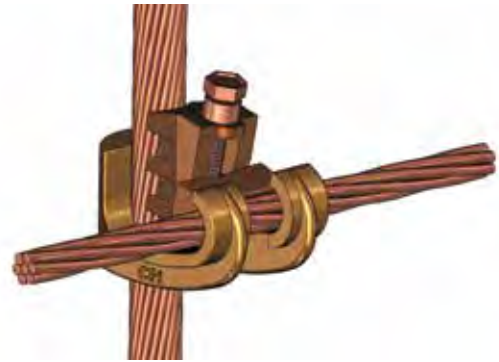

Features and Benefits

- No special molds, chemicals, tools, dies or fired-on charges necessary for installation; installed with a common socket, impact or ratchet wrench
- No temperature or weather restrictions for installation; can be installed no matter what environment exists at the job site
- Shear-head bolt ensures consistency of application and positive verification of a completed connection
- Fully tested to IEEE standard 837 for:
 - Mechanical Pullout
 - Electromagnetic Force
 - Current-Temperature Cycling
 - Freeze-Thaw
 - Corrosion-Nitric Acid
 - Fault Current, 35 kA rms. sym. at .02 sec.
 - Thermal Shock and Accelerated Corrosion
- Typical applications:
 - Substation ground grids
 - Pole grounds transmission line grounding
 - Industrial/Residential service grounds
 - Pad Mount Transformers
 - Telco distribution / CATV grounds
 - Wind Farms

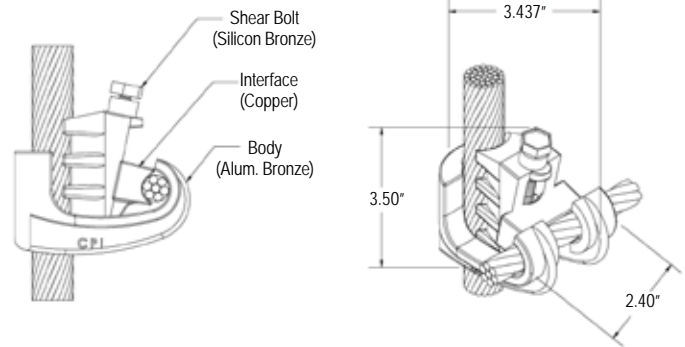

Catalog Number	Conductor			
	Vertical	Vertical Dia. Range	Horizontal	Horizontal Dia. Range
900200	500 kcmil, 450 kcmil	.813", .769"	500 kcmil, 450 kcmil	.813", .769"
	500 kcmil	.813"	400 kcmil	.726"
900201	500 kcmil, 450 kcmil	.813", .769"	350 kcmil, 300 kcmil, 3/4 Rod	.679", .629", .680"
	450 kcmil, 400 kcmil	.769", .726"	400 kcmil	.726"
900202	500 kcmil, 450 kcmil	.813", .769"	250 kcmil, 5/8" Rod, 4/0 Str	.574", .556", .522"
	350 kcmil	.679"	350 kcmil, 300 kcmil, 3/4 Rod	.679", .629", .680"
	400 kcmil	.726"	250 kcmil, 5/8" Rod	.574", .556"
900203	500 kcmil, 450 kcmil	.813", .769"	1/0 Str, 2/0 Str	.368", .419"

CPI™ Running Rail Connectors Single and Two-Conductor Styles

CPI Running Rail Connectors are designed as a permanent connection for copper conductor to a variety of rails used in Heavy Rail Mass Transit systems. Constructed with a heavy duty aircraft-quality steel spring member, copper cable nest, indenter, hex head bolt and locking nut.

Features and Benefits

- No drilling in rail or need to weld conductor to the rail!
- Rail is not subjected to warping by excessive heat or to weakening by drilling
- Labor saving, installation time can take as little as 10 minutes per connection
- Fewer rail connections required due to large conductor capacity (Single conductors up to 1000 kcmil; Dual conductors up to 750 kcmil)
- Large conductors can be bent away from the rail after installation without the risk of damaging the connector
- The clamp is an active spring applying a consistent force on the conductor ensuring a positive connection through heat cycling and train vibration
- The J-shaped spring member of the connector helps overcoming loosening issues problems associated with harsh train vibration by flexing rather than breaking; a static-type connection doesn't have this resiliency and could crack under prolonged vibration
- Consistent spring pressure prevents moisture and contamination from seeping into the connection
- All copper components are tin plated and steel components are galvanized

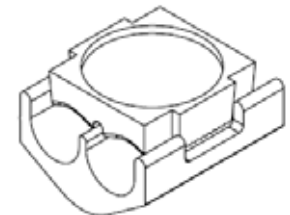
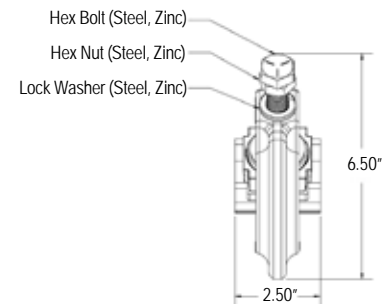
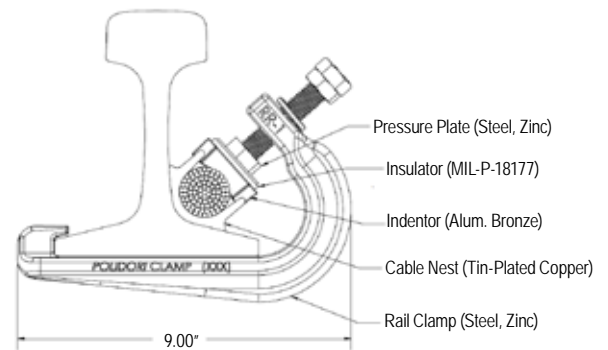

115-2-500 Nest Configuration

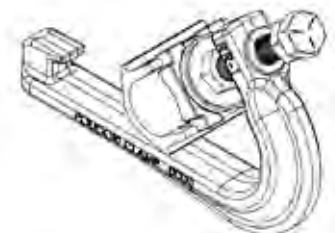

115-1000A Nest Configuration

Single Conductor Connectors		
Catalog Number	Rail Size & Type	Conductor Size Range
85-1000	85 lb ASCE	1000 kcmil
90-1000	90 lb ASCE	1000 kcmil
115-500	115 lb AREMA, 119 lb AREMA	500 kcmil
115-750	115 lb AREMA, 119 lb AREMA	750 kcmil
115-1000A	115 lb AREMA, 119 lb AREMA	1000 kcmil - 1250 kcmil
136-500	136 lb AREMA	500 kcmil
Two Conductor Connectors		
85-2-500	85 lb ASCE	TWO: 250 kcmil - 500 kcmil
90-2-500	90 lb ASCE	TWO: 250 kcmil - 500 kcmil
115-2-500	115 lb AREMA, 119 lb AREMA	TWO: 250 kcmil - 500 kcmil
115-2-750	115 lb AREMA, 119 lb AREMA	TWO: 750 kcmil
136-2-500	136 lb AREMA	TWO: 250 kcmil - 500 kcmil

Contact the factory for any rail or conductor combination not listed

CPI™ Contact Rail Connectors Single and Two-Conductor Styles

CPI Contact Rail Connectors are designed as a permanent connection for copper conductor to a variety of rails used in heavy rail Mass Transit systems. Constructed using a heavy duty aircraft-quality steel spring member, copper cable nest, indenter, hex head bolt and locking nut.

Features and Benefits

- No drilling in rail or need to weld conductor to the rail!
- Rail is not subjected to warping by excessive heat or to weakening by drilling
- Labor saving, installation time is 1/6 man hours
- Fewer rail connections required due to large conductor capacity (Single conductors up to 2000 kcmil; Dual conductors up to 750 kcmil)
- Large conductors can be bent away from the rail after installation without the risk of damaging the connector
- The clamp is an active spring applying a consistent force on the conductor ensuring a positive connection through heat cycling and train vibration
- The J-shaped spring member of the connector helps overcoming loosening issues problems associated with harsh train vibration by flexing rather than breaking; a static-type connection doesn't have this resiliency and could crack under prolonged vibration
- Consistent spring pressure prevents moisture and contamination from seeping into the connection
- All copper components are tin plated and steel components are galvanized

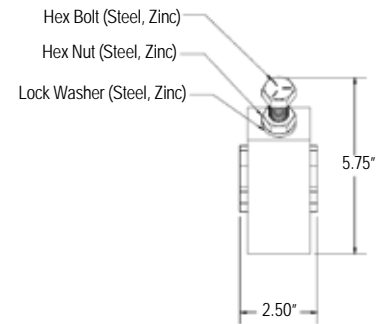
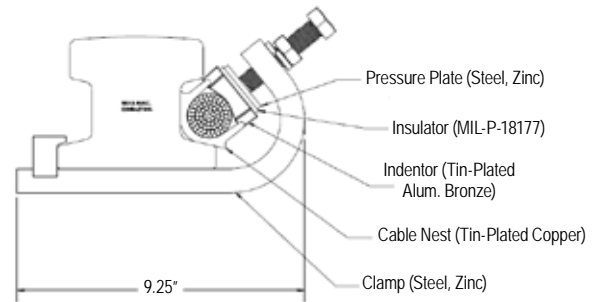
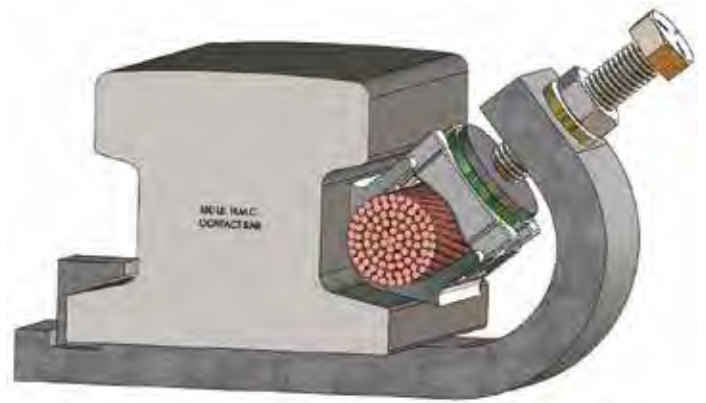

Single Conductor Connectors		
Catalog Number	Rail Size & Type	Conductor Size Range
150-1000	150 lb NMC	1000 kcmil
150-2000	150 lb NMC	2000 kcmil
Two Conductor Connectors		
150-2-500	150 lb NMC	TWO: 250 kcmil - 500 kcmil

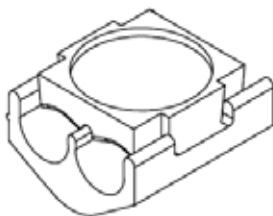

150-2-500 Nest Configuration

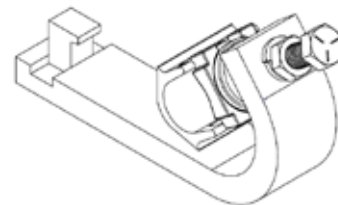

150-1000 Nest Configuration

CPI™ 2000 kcmil Cathode Connector “Pot Head” Connector

CPI Cathode Connector (also known as “Pot Head” connector) is designed to connect a single 2000 kcmil conductor from the main feeder directly to the Third Rail. Used in conjunction with the CPI Contact Rail Clamp, a Pot Head connector can replace the need for having 4 separate 500 kcmil connections with one single 2000 kcmil connection.

Features and Benefits

- Constructed of high conductivity copper
- The assembly comes standard with a tin-plated finish (image shows unplated)
- Incorporates the use of stainless steel hardware for increased strength and corrosion resistance
- Optional molded fiberglass cover is also available
- Simple 4-bolt installation
- Eliminates the need for any welding
- Recommended for use with the CPI 2000 kcmil Contact Rail Connector

Catalog Number	Description
22000	2000 kcmil Cathode Connector
750336	Fiberglass Insulated Cover

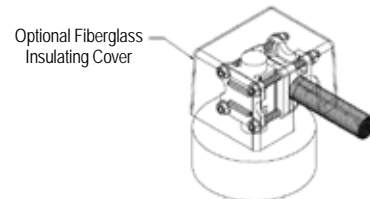
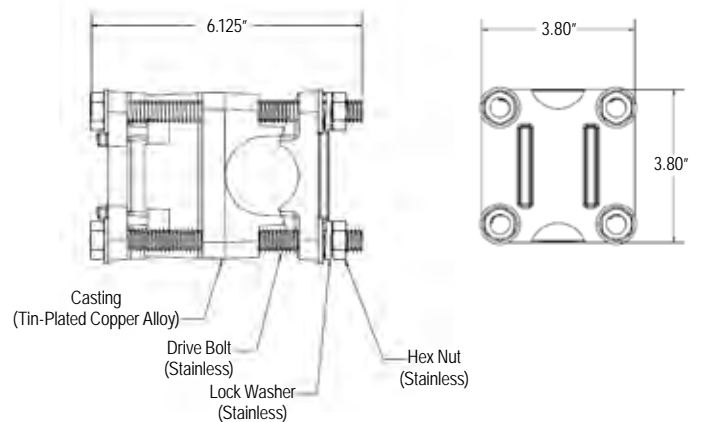

CPI™ Single Cable Support Spring Rail Clips Support for Signal Cables Near Rail

CPI Support Spring Rail Clips are designed to support and hold a variety of Signal cables or conductors in close proximity to the rail.

Features and Benefits

- Tempered spring steel wire construction
- All components are plated or galvanized to resist corrosion
- Quick and easy to install
- Removable and reusable
- Available in different configurations to accommodate different size rails and multiple conductor combinations

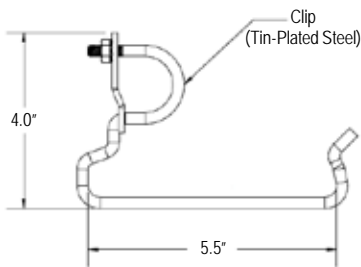

Figure 1

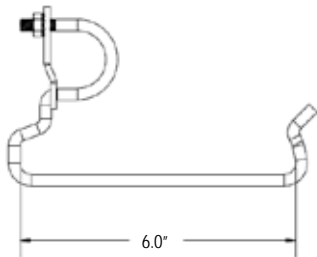

Figure 2

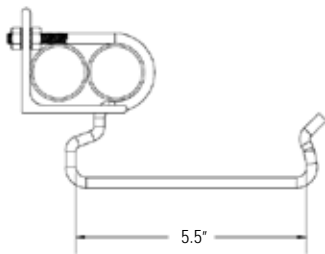

Figure 3

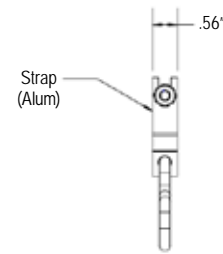

Figure 4

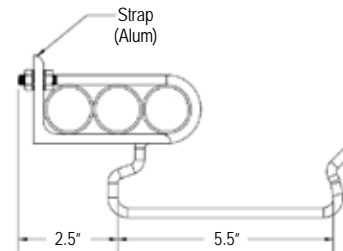
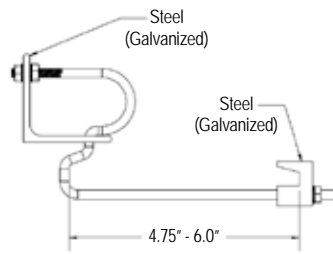

Figure 5



Catalog Number	Figure	Rail Size & Type	Cable O.D. & Capacity
115-250	1	115 lb AREA	1.25" x 1
140-375	2	140 lb AREA	1.375" x 1
115-250-2S	3	115 lb AREA	1.095" x 2 - 1.365" x 2
115-250-3	4	115 lb AREA	1.302" x 3
100-ARA-B-250-2	5	100 ARA-B	1.095" x 2 - 1.365" x 2

Options:

Add Suffix "N" to specify a stainless steel nylon insert nut.
(Standard is Zinc-plated kept nuts.)

Table of Contents

Underground Network Distribution Products

Technical Data: Underground System Connection & Protection..... K-3

Types of Underground Connectors & Accessories..... K-4

Multiple Outlet Connectors Technical Data..... K-5

BURNDY® MOLE™ Selection Considerations..... K-8

Bus Configuration Illustrations..... K-8

MOLE™ Ordering Matrix..... K-9

MOLE™ Types..... K-10

MOLE™ Stud Connector Types..... K-13

MOLE™ Accessories..... K-17

HYCRAB™ Technical Data..... K-23

HYCRAB™ and Accessories..... K-23

Network Protection General Information..... K-25

Limiters and Accessories..... K-27

High Capacity Limiters..... K-47

Underground Residential Distribution Products

Stud MOLE™, URD MOLE™ and Tap Kits..... K-49

Overhead or Underground Secondary Connectors

URD Insulated Splice Kit Type YS-CG..... K-51

HYREDUCER™ Splices Type YRB-U..... K-52

HYREDUCER™ Splices Type YRB-T..... K-55

URD Service Tap Types K-P-C..... K-56

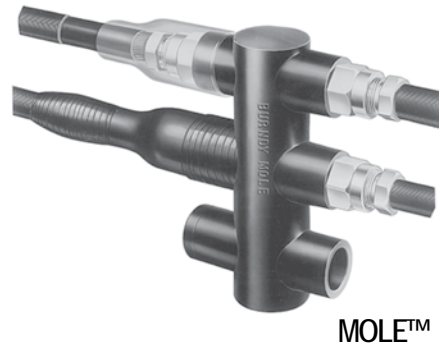

Table of Contents - Products for Underground Network Distribution Systems

MOLE™	
Type ZM.....	K-10
Type ZMT.....	K-11
Type ZMX.....	K-12
MOLE™ Stud Connectors	
Type ZMLDN.....	K-13
Type Z2MLDN.....	K-15
Type ZMDN.....	K-16
Type ZMTDN.....	K-17
MOLE™ Outlet Plugs	
Type Z-P.....	K-17
Socket and Nut Assembly	
Type Z-NR.....	K-18
MOLE™ Compression Cone	
Type Z (Concentric & Compressed Conductor).....	K-19
Type Z (Compact Conductor).....	K-20
MOLE™ Coupler	
Type ZMS.....	K-21
MOLE™ Sleeves	
Type Z-C (Outlet Insulating Sleeve).....	K-21
HYCRAB™	
Type YM.....	K-23
Type ZNM.....	K-24
Limiters	
Types YFS-CR, YFS-CP.....	K-27
Type YFS-CPL.....	K-28
Types YFSR, YFSP.....	K-29
Type YFSP-L.....	K-30
Types YFA-CR, YFA-CP.....	K-31
Type YFA-CPL.....	K-32
Types YFAR, YFAP.....	K-33
Type YFAP-L.....	K-34
Types YFM-CR, YFM-CP.....	K-35
Type YFM-CPL.....	K-36
Types YFMR, YFMP.....	K-37
Type YFMP-L.....	K-38
Type VYFT.....	K-39
Type NYFT.....	K-39
Type LYS.....	K-40
Type LYM.....	K-41
Type LF.....	K-42
Type LYBASEH.....	K-43
Type LYS34P2.....	K-43
Type LYS-P5.....	K-44
Type LYM34P3.....	K-45
Type LYS-P6.....	K-45
T-Connector	
Type NYT.....	K-46
High Capacity Limiter Information.....	K-47
Stud MOLE™, URD MOLE™	
Type RDMD-2858D.....	K-49
Type RDM-28.....	K-49
Types RA6UC-SL, RA6UCR-SL.....	K-49
MOLE™ Tap Kits	
Types RYA-UC, RYA-AC, RYA-UCR, RYA-ACR.....	K-50
URD Insulated Splice Kit	
Type YS-CG.....	K-51
HYREDUCER™ Splice	
Type YRB-U.....	K-52
Type YRB-T.....	K-55
URD Service Tap	
Type K-P-C.....	K-56
Variable Shear Shearbolt Splice	
Type NSSBA.....	K-57

Underground System Connection and Protection

Nowhere in the distribution of electrical power are the problems of connecting conductors and equipment against the effects of fault currents as complex as in underground systems. For more than 85 years, BURNDY® engineers have worked closely with utilities to develop devices for connecting and protecting conductors and associated equipment in underground systems. These devices, with their inherent dependability and economy, have contributed to the rapid growth of underground systems throughout the country. To assist utility personnel in more effectively selecting and applying these devices, the engineering talent and experience of BURNDY have been pooled to prepare this technical section, and the catalog information that follows.

These devices are designed for use in both radial and network type underground systems. Radial systems (Fig. 1) distribute power economically except in high load density areas where a high degree of service reliability is required.

Network systems (Fig. 2) have become standard for AC power distribution where load density is high and service continuity must be assured under nearly all conditions. The improved equipment and methods which are described in this catalog have been designed to meet these secondary network system requirements and to reduce the cost of installation and maintenance.

Early Problems in Underground Connections

Despite the many advantages of underground distribution, a major problem was that of making connections in congested manholes or junction boxes. The necessary procedure - soldering conductors, taping joints, and wiping lead covered cable - was so complex, that it demanded considerable skill and was time consuming and costly. This involved procedure had to be repeated each time a service was added to a main. When completed, the multiple-branch joints were excessively bulky and their electrical and mechanical performance suffered from the shortcomings of soldered connections.

The installation of underground distribution made greater strides as those early connection methods gave way to specialized products and techniques developed by BURNDY at the request of, and in close collaboration with, engineers of leading utilities. These specialized connectors were easier and more economical to install, more compact, and more dependable electrically and mechanically.

For installation in conjunction with these connectors, BURNDY also developed products to protect the secondary system from the effects of fault currents. The continuing improvement of these products based on field experience and laboratory research, is contributing to even greater dependability and economy in underground distribution.

Design Objectives in Connectors for Underground

While each of the principal types of equipment described in the following pages has been designed to meet particular service requirements, all have several basic objectives in common:

Reliability: To minimize outages and their serious consequences in the high load density areas serviced by underground systems.

Ease of Installation: Compact for easy installation in the confined space of a manhole and transformer vaults. Mechanical connections that eliminate difficult solder joints.

Economy: By reducing the time and skill required for installation of a dependable, insulated compact connection.

Versatility: For permitting easier changes, expansion, and additional services with a minimum of system shutdown.

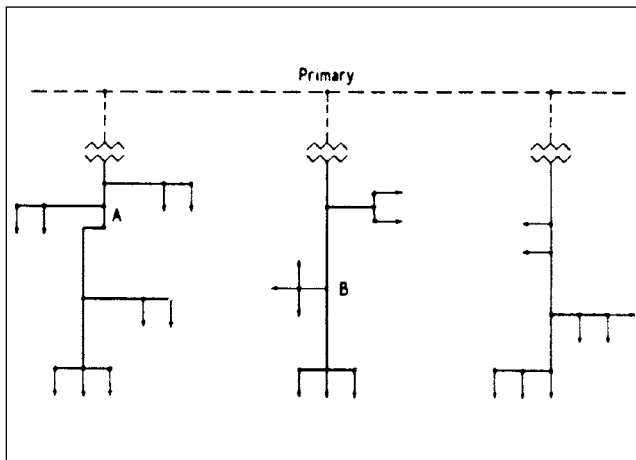

Figure 1: Radial Secondary Distribution System

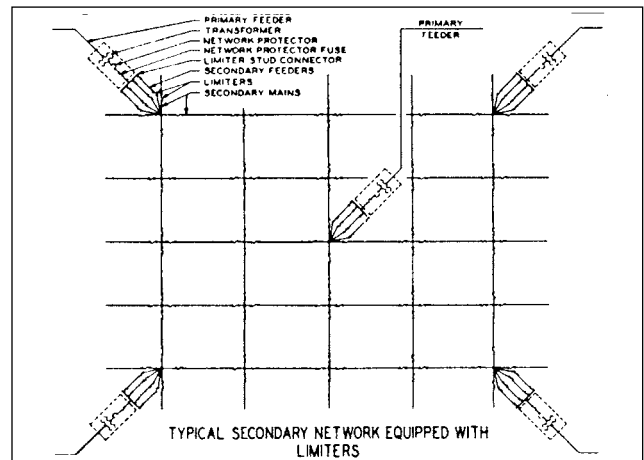

Figure 2: Typical Secondary network Equipped with Limiters

Underground Connectors and Accessories

The MOLE™ and HYCRAB™

The most popular of the engineered connectors developed specifically for underground manholes and transformer vaults are the MOLE™ and HYCRAB™ that provide for multiple connections at a single junction point of main, feeder, and service cables. Pre-insulated to eliminate extensive taping, these connectors are essentially bus bars with several cable outlets: mechanical installation of the MOLE™, and compression installation in the HYCRAB™.

Limiters and Fuses

To prevent "roasting" of cable insulation, resulting from fault current, BURNDY has developed cable limiters that are inserted in each secondary cable at all junction points. Network protector fuses have been designed to back up the protector breaker in the event of a malfunction during a transformer or primary cable fault. By coordinating the time current characteristics of the fuse with those of the cable limiters, the possibility of limiter blowing on primary faults is eliminated, which in turn reduces the fault finding task. Also, limiter, fuse, and cable insulation characteristics must be carefully coordinated to assure isolating a fault on the secondary before it can cause extensive damage or interrupt service in other sections of the secondary system.

High Capacity Limiter 200,000 Amperes at 600 Volts

The BURNDY® High Capacity Limiter is designed to economically protect electrical distribution systems from the destructive effect of high energy faults. The increasing number of 600 volt secondary network installations for industrial and commercial applications demand a cable limiter that can safely interrupt 200,000 amperes (symmetrical available) and one that will also completely coordinate with the higher voltage network protector fuses.

Available fault currents as high as 200,000 amperes rms at 600 volts across the fusible elements have been interrupted during tests on the BURNDY® High Capacity Limiter. The power factor during these tests was less than 15%, thereby imposing the most difficult clearing conditions. No external disturbance is experienced upon clearing fault currents from the "float" value to 200,000 amperes. The quartz filler absorbs the intense energy generated by interrupting the fault current. The quartz fuses into tubular fulgurites, with a high dielectric strength, and forms an insulating barrier between the melted link sections. This action prevents restrike of the internal arc. The rugged glass melamine housing provides a vessel that completely contains the developed energy.

This carefully developed time-current characteristics and rigid manufacturing tolerances assure proper coordination with the network protector fuses and the insulation damage characteristics of 4/0, 250, 350, 500, and 750 kcmil cable.

The High Capacity Limiter is available in four variations to accommodate a variety of installation practices. The Type HYS has cable sockets at both ends, which allow for indenting to the cable ends with a hydraulic BURNDY® HYPRESS™. The HYAO type has an offset lug on one end which permits back-to-back mounting on bus bar.

For those installations where the BURNDY® MOLE™ product is used for manhole junctions or transformer vault buses, the Type HYM permits a replaceable connection of the limiter directly to the MOLE outlet at one end and a compression cable connection at the other.

Modern electrical distribution systems require low cost protection to safeguard costly equipment and quickly isolate faults, so that the undamaged portions of the system may function normally. BURNDY® High Capacity Limiters assure positive, economical protection when installed in properly designed systems.

Compression Connectors

BURNDY® HYDENT™ compression type connectors, and installation tools, have been designed for splicing and terminating copper as well as aluminum underground cables, in both primary and secondary circuits. BURNDY tools and dies are custom designed to produce sound electrical, and mechanical joints on BURNDY connectors. The use of the BURNDY® Engineered System with matched tools, connectors and dies, assures optimum results.

Residential Underground

The trend toward improvement in neighborhood appearances, and the elimination of storm outages, tree trimming, etc. has created the need for residential underground distribution. To meet these needs, BURNDY offers: Mechanical type pre-insulated multi-conductor terminal connectors for submersible transformer locations; and compact multiconductor connectors for above ground transformer and enclosures. For service taps, BURNDY offers: Pre-insulated multi-conductor compression and mechanical connectors; and a range taking compression connector for below grade service. Power pedestals for direct burial, above ground application, and conduit systems are offered. Residential Underground Fuse Block assembly with replaceable fuse for each service cable is also available.

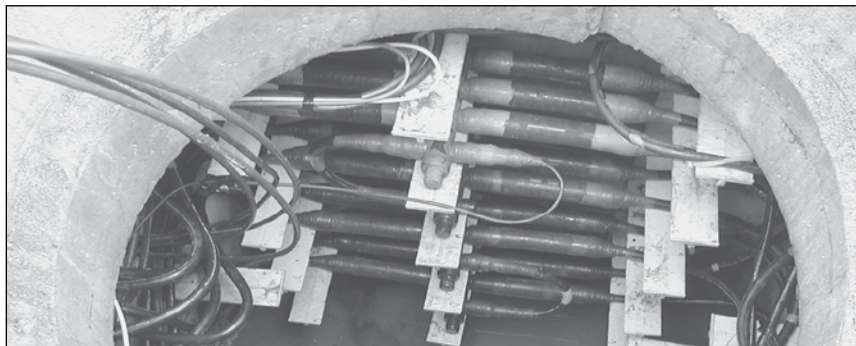

Multiple Outlet Connectors

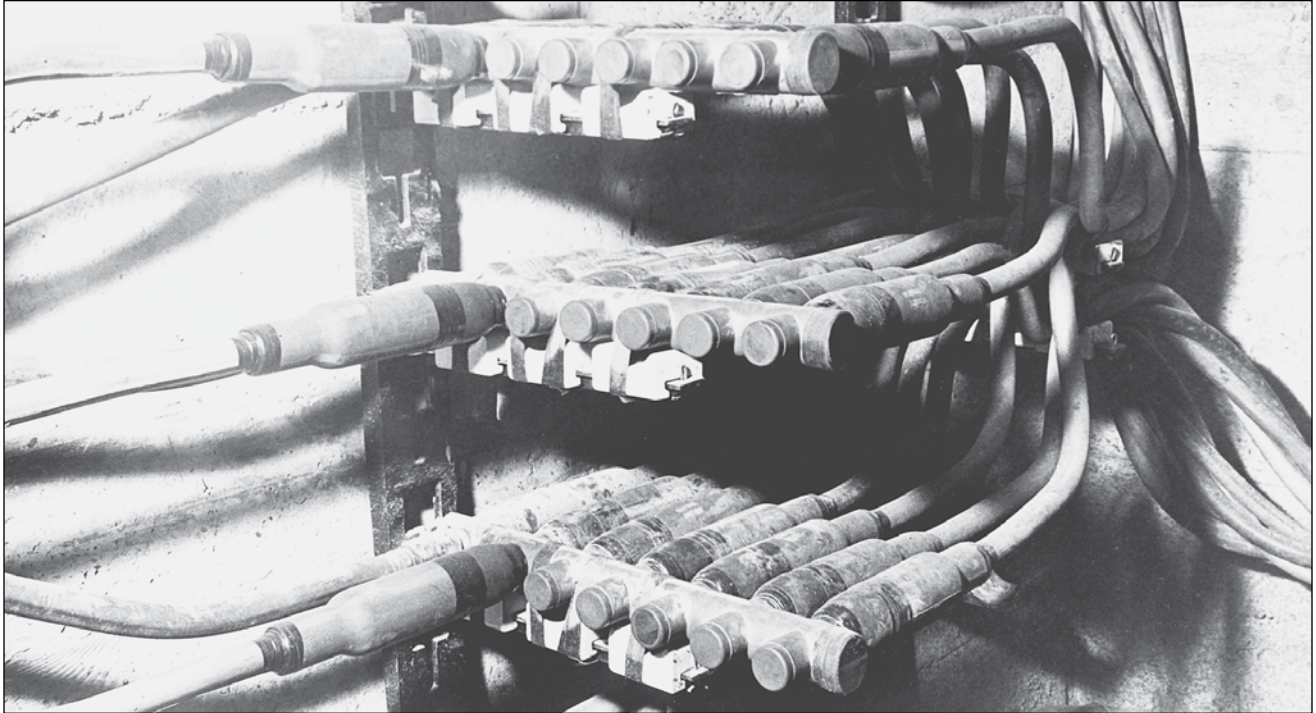

Connectors for Aluminum

For systems where aluminum is used, connectors especially designed for aluminum conductors are available in bolted and compression types: HYCRAB™, HYPLUG™, HYREDUCER™, and HYSOCKET. Aluminum conductors can be connected to standard MOLE™ connectors by using HYPLUG™ YE-R type adapters in catalog section H. Contact customer service for specific recommendations to connect aluminum conductor to MOLE™ and HYCRAB™ multiple outlet connectors.

Multiple Outlet Connectors

The increasing use in modern electrical distribution systems of junction points where several relatively large cables must be connected, has brought about the development of BURNDY® MOLE™ line equipment to speed up and simplify the making of such connections. The modern tendency toward network systems not only in underground utility practice but also in industrial wiring, has greatly increased the number of multi-connection joints.

The BURNDY® MOLE™ and HYCRAB™ connectors are insulated bus bars with multiple connector outlets for service cables, secondary mains or equipment leads. In the MOLE™, clamping action secures conductors to the connector; in the HYCRAB™, connections are made by indenting with a compression tool. Both lines of insulated connectors offer the following basic advantages:

1. **Ease of Economy and Installations:** The ease and reduction of time required to make and insulate dependable multi-connections greatly reduces the cost of installation. The compact design makes maximum use of space and provides for simplified racking.

2. **Versatility for System Modification:** The MOLE™ and HYCRAB™ are designed to accommodate the secondary main and service cables, and permit easy modification or later additions. The numerous available connector configurations permit a wide variety of arrangements of cables and equipment connections. The 600 volt rating of the MOLE™ and HYCRAB™ insulation provides for efficient operation at all standard utilization voltages.
3. **Efficient, Dependable Performance:** The MOLE™ and HYCRAB™ connectors assure permanent, high conductivity connections, good moisture seal, and insulation that resists the severest condition encountered in underground installations.

MOLE™ and HYCRAB™ Insulation

The location in vaults and manholes often exposes these connectors to immersion in water, chemical, and other contaminants, as well as to heat from overload or fault currents. The MOLE™ and HYCRAB™ insulations provide electrical, mechanical, and thermal properties essential to assure the service continuity of underground distribution systems.

Recognizing the importance of proper connection insulation, BURNDY established performance specifications exceeding those of 600 volt cable insulation.

Multiple Outlet Connectors (Continued)

The MOLE™ and MOLE™ Accessories

The BURNDY® MOLE™ is a multi-cable connectors that consists of a pre-insulated copper bus bar with threaded outlets that permit a minimum of two cables to be connected by means of a socket, nut, and cone assembly (Illustration A). The clamping action of the socket, nut, and cone assembly on the cable develops high contact pressures that maintain joint conductivities greater than 100% of the continuous conductor.

The MOLE™ design affords exceptional versatility in four ways:

1. MOLE™ outlets can be plugged-off until needed for the addition of cables.
2. Installed cables can be easily removed.
3. Cable sizes can be increased by changing the socket, nut, and cone assembly.
4. The number of outlets may be increased by joining MOLE™ connectors with a MOLE™ coupler.

Insulation

The copper bus bar insert is encased in a molded insulating jacket that eliminates copper crotch taping. The thickness of the jacket prevents any possibility of the insert weight to cause the insulation at the supports to flow away at the high temperatures of fault conditions.

Ratings

MOLE™ connectors are rated at 1500, 2000, 2500, and 3000 amperes, based on the maximum current the insert cross-section can carry. Each outlet can carry the full rated current of the cable connected to it.

To avoid exceeding the insert rating, the cables should be arranged in such a manner that most current flows directly across the insert. (See Illustration B.)

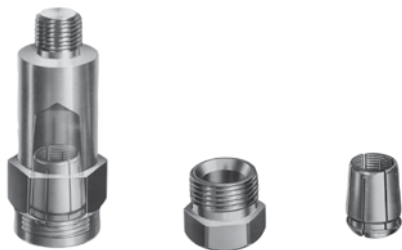

Illustration A

Installation

Cables are connected to the MOLE™ by means of a socket, nut and compression cone assembly. The socket is threaded into the MOLE™ insert. The stripped cable end is inserted into nut and compression cone, and then into the socket where it is securely clamped by tightening the nut. The joint is then sealed watertight in one of three ways:

- Taping;
- MOLE™ Outlet Insulating Sleeves, sealed with a minimum of taping;

Tests under flooding and other adverse conditions demonstrate that such joints are impervious to water.

Accessories

A socket, cone and nut assembly is screwed into each MOLE™ outlet to which a cable is to be connected. The socket has a tapered recess into which the clamping nut forces the cable into the compression cone. The cone is slotted to controlled widths and depths for maximum flexibility, and its inside surface is serrated for low contact resistance and high pullout strength.

Plug seal MOLE™ outlets not in use. The MOLE™ is delivered with one-fourth of its outlets sealed with plugs. Additional plugs may be ordered.

MOLE™ couplers facilitate system expansion by joining additional MOLE™ connectors to those already installed. Couplers are easily installed in end or side outlets of the MOLE™, and make connections that are effective both electrically and mechanically.

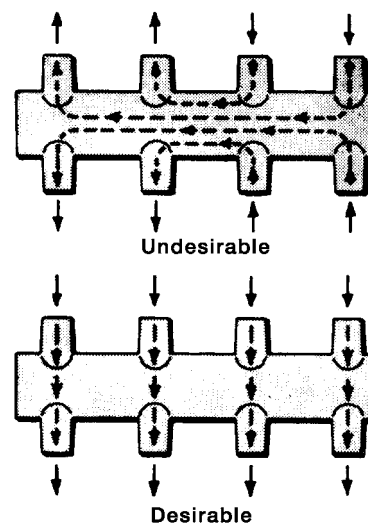
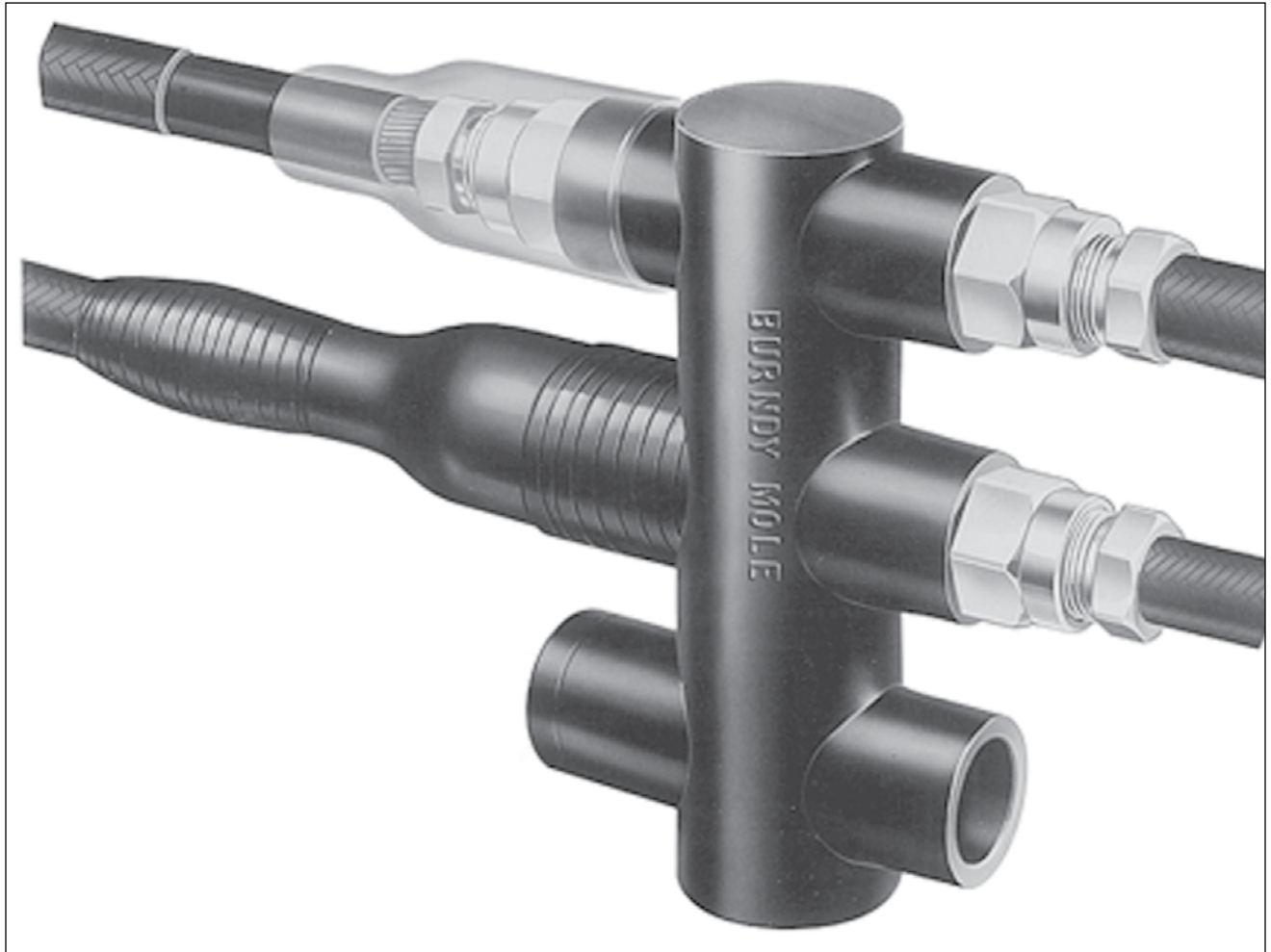

Illustration B

Multiple Outlet Connectors (Continued)



MOLE™ Connector Selection Considerations

Conductor Type:

- Copper Stranded - Adapts directly to MOLE™ using Z-NR type socket nut and Z MOLE™ compression cone
- Aluminum Stranded - Use type YE-R HYPLUG™ to adapt to Z-NR style socket nut and Z MOLE™ compression cone (contact customer service for recommendations)

Amperes:

- Ratings are for maximum current at any point along the cross section of the connector bus
- Each outlet is rated for the full current capability of the attached conductor or coupler
- This catalog shows 1500, 2500, and 3000A variations; contact customer service for other ampacity ratings

MOLE™ Bus Configuration:

- Selection based on desired conductor routing
- Determine if multiple MOLE™ connectors will be joined; End connection points (1) / (X) in ZMT, ZML, ZMX, and ZMK style configurations are often used for this purpose
- See descriptions in the ordering matrix and illustrations
- Contact customer service for ordering tables for configurations not included in this catalog

Number of Outlets:

- 2 to 18 outlets are available on a single MOLE™ depending on bus configuration
- Connect multiple MOLE™ bus together if a greater number of outlets is required

Connection Point Configuration:

- See "Connection Point Options" table to determine the size required

End connection point (1) / (X) size can be made different from those on the bus side(s) (2 - n) by changing the part number suffix.

Contact customer service for options to have different size connection points on the side(s) of the MOLE™ bus.

Bus Configuration Illustrations

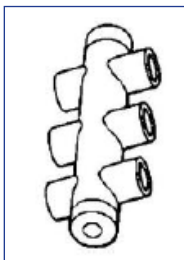

ZM

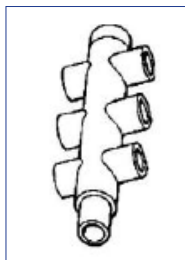

ZMT

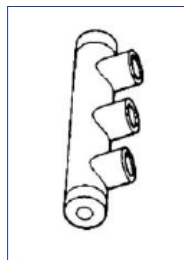

ZME

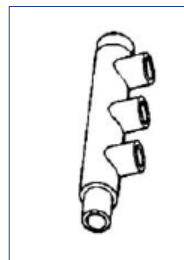

ZML

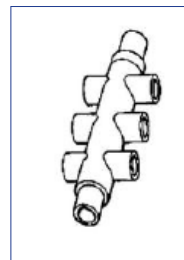

ZMX

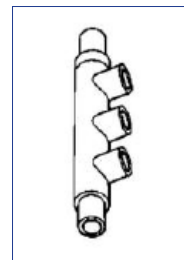

ZMK

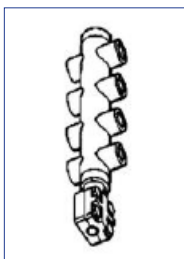

ZMTDN

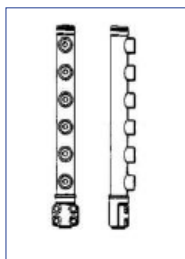

ZMLDN

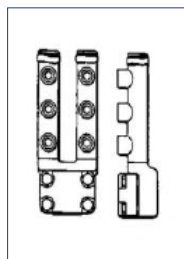

Z2MLDN

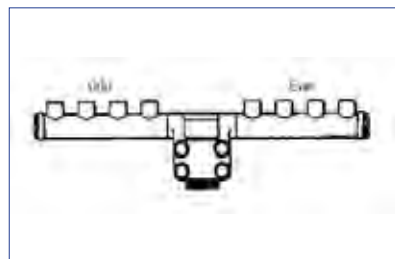

ZMDN

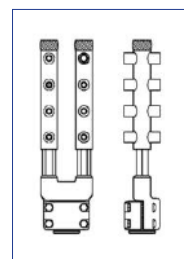

Z2MTDN

Ordering Matrix

Catalog Number Example: ZMT725A7			
ZMT	7	25	A7
Bus Configuration	Total Qty Connection Points	Amperage Rating	Connection Point Configuration

Bus Configuration (See Illustrations)	
Value	Description
ZM	Both Sides
ZMT	Both Sides + 1 End
ZMX	Both Sides + 2 Ends
ZME	One Side
ZML	One Side + 1 End
ZMK	One Side + 2 Ends
ZMDN	Horizontal Stud MOLE™
ZMLDN	One Side Vertical Stud MOLE™, 1 Tree
Z2MLDN	One Side Vertical Stud MOLE™, 2 Trees
ZMTDN	Both Sides Vertical Stud MOLE™, 1 Tree
Z2MTDN	Both Sides Vertical Stud MOLE™, 2 Trees

Ampere Rating	
Value	Amp Rating
15	1500
20	2000
25	2500
30	3000

Connection Point Configuration			
Value	Bus Config	Primary Size	End Size
None	All	A	A
B		B	B
C		C	C
A3	ZMT or ZML	A	B
A9		A	C
B12		B	A
B92	ZMX or ZMK	B	C
A4		A	B
A7		A	C
B72	B	C	

Connection Point Options			
Socket Size	Compact Stranding	Concentric / Compressed	MOLE™ to MOLE™ Coupler
A	#2 - 600 kcmil	#6 - 600 kcmil	ZMS29 (1200A)
B	2/0 - 750 kcmil	250 - 1000 kcmil	ZMS34 (1600A)
C	Contact Customer Service	1250 - 2000 kcmil	ZMS40 (2000A)

OUTLET HOLE NUMBERING

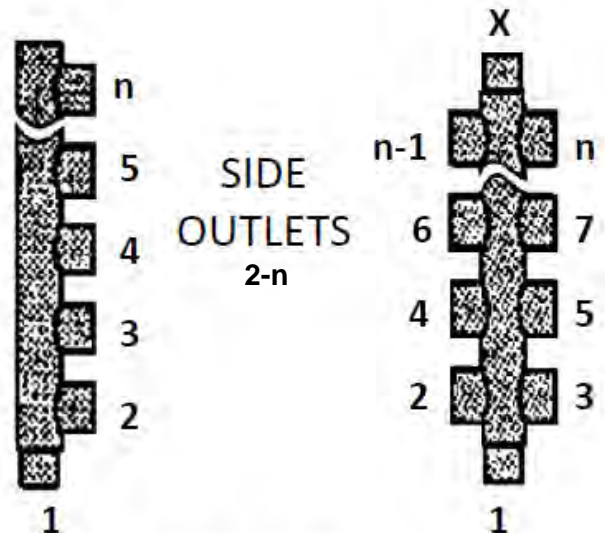

END OUTLETS
1 and X

MOLE™ Type ZM

MOLE™ Type ZM — A compact pre-insulated junction for secondary network cables, with multiple outlets for each cable clamping elements.

Outlet Plugs — MOLE™ outlet plugs that facilitate sealing outlets not being used are available. Type Z-P and Type K-P, sold separately.

Insulating Sleeves — Taping operations for watertight joints are greatly simplified by the use of BURNDY® Type CM or MOLE™ Insulating Sleeves Type Z-C, sold separately.

Clamping Elements — Outlet Symbols A or B, refer to socket and nut Type Z-NR, and Cone Type Z cable clamping elements accommodated. These must be ordered separately.

OUTLET RANGE: "A" 6 Str. - 600 kcmil
"B" 2 Str. - 1000 kcmil

Catalog Number	Ampere Capacity	Cable Outlet Arrangement	Qty of Outlets	Length "L" Inches
ZM415	1500	All Outlets A	4	7.1
ZM615			6	10.1
ZM815			8	13.1
ZM1015			10	16.1
ZM1215			12	19.1
ZM1415			14	22.1
ZM1615			16	25.1
ZM425	2500	All Outlets A	4	8.0
ZM625			6	11.5
ZM825			8	15.0
ZM1025			10	18.5
ZM1225			12	22.0
ZM1425			14	25.5
ZM1625			16	29.0
ZM430	3000	All Outlets A	4	6.9
ZM630			6	10.3
ZM830			8	13.7
ZM1030			10	17.1
ZM1230			12	20.4
ZM1430			14	23.8
ZM1630			16	27.2

MOLE™ DIMENSIONS

"W" Dimension: 4-1/8"
Center-to-Center distance between outlets: 3"

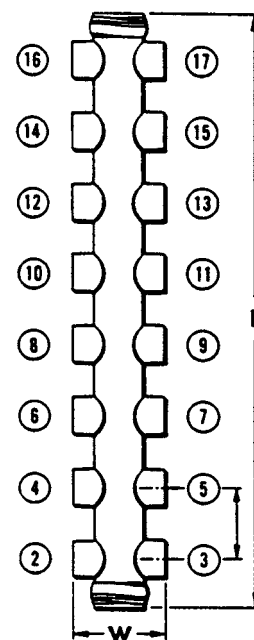

Catalog Number	Ampere Capacity	Cable Outlet Arrangement	Qty of Outlets	Length "L" Inches
ZM425B	2500	All Outlets B	4	8.0
ZM625B			6	11.5
ZM825B			8	15.0
ZM1025B			10	18.5
ZM1225B			12	22.0
ZM1425B			14	25.5
ZM1625B			16	29.0
ZM430B	3000	All Outlets B	4	6.9
ZM630B			6	10.3
ZM830B			8	13.7
ZM1030B			10	17.1
ZM1230B			12	20.4
ZM1430B			14	23.8
ZM1630B			16	27.2

Contact Customer Service for Additional Outlet Configurations



MOLE™ Type ZMT

MOLE™ Type ZMT — A compact pre-insulated junction for secondary network cables, with multiple outlets for cable clamping elements. Future expansion is provided for by an end outlet which can be joined to an additional MOLE™ by Type ZMS couplers.

Outlet Plugs — MOLE™ outlet plugs that facilitate sealing outlets not being used are available. Type Z-P and Type K-P, sold separately.

Insulating Sleeves — Taping operations for watertight joints are greatly simplified by the use of BURNDY® Type CM or MOLE™ Insulating Sleeves Type Z-C, sold separately.

Clamping Elements — Outlet Symbols A or B, refer to socket and nut Type Z-NR, and Cone Type Z cable clamping elements accommodated. These must be ordered separately.

OUTLET RANGE: "A" 6 Str. - 600 kcmil
"B" 2 Str. - 1000 kcmil

Catalog Number	Ampere Capacity	End ① *	Other	Qty of Outlets	Length "L" Inches
ZMT315	1500	A	A	3	5
ZMT515				5	8
ZMT715				7	11
ZMT915				9	14
ZMT1115				11	19
ZMT1315				13	20
ZMT1515				15	23
ZMT1715				17	26
ZMT325	2500	A	A	3	5.5
ZMT525				5	9
ZMT725				7	12.5
ZMT925				9	16
ZMT1125				11	19.5
ZMT1325				13	23
ZMT1525				15	26.5
ZMT1725				17	30
ZMT330	3000	A	A	3	5.5
ZMT530				5	9
ZMT730				7	12.5
ZMT930				9	16
ZMT1130				11	19.5
ZMT1330				13	23
ZMT1530				15	26.5
ZMT1730				17	30

MOLE™ DIMENSIONS

"W" Dimension: 4-1/2"
Center-to-Center distance between outlets: 3-1/2"

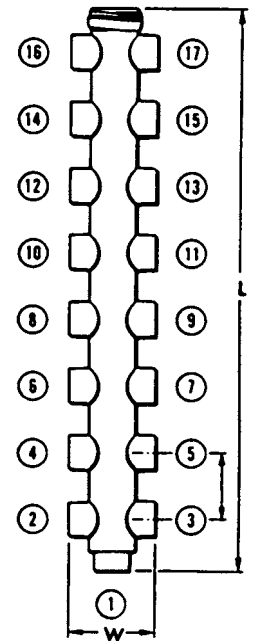

Catalog Number	Ampere Capacity	End ① *	Other	Qty of Outlets	Length "L" Inches
ZMT325B	2500	B	B	3	5.5
ZMT525B				5	9
ZMT725B				7	12.5
ZMT925B				9	16
ZMT1125B				11	19.5
ZMT1325B				13	23
ZMT1525B				15	26.5
ZMT1725B				17	30
ZMT330B	3000	B	B	3	5.5
ZMT530B				5	9
ZMT730B				7	12.5
ZMT930B				9	16
ZMT1130B				11	19.5
ZMT1330B				13	23
ZMT150B				15	26.5
ZMT1730B				17	30



*Add Suffix "A3" to Change End Outlet ① to Size B
*Add Suffix "A9" to Change End Outlet ① to Size C
Contact Customer Service for Additional Outlet Configurations.

MOLE™ Type ZMX

MOLE™ Type ZMX — A compact pre-insulated junction for secondary network cables, with multiple outlets for cable clamping elements. Future expansion is provided for by an end outlet which can be joined to an additional MOLE™ by Type ZMS couplers.

Outlet Plugs — MOLE™ outlet plugs that facilitate sealing outlets not being used are available. Type Z-P and Type K-P, sold separately.

Insulating Sleeves — Taping operations for watertight joints are greatly simplified by the use of BURNDY® Type CM or MOLE™ Insulating Sleeves Type Z-C, sold separately.

Clamping Elements — Outlet Symbols A or B, refer to socket and nut Type Z-NR, and Cone Type Z cable clamping elements accommodated. These must be ordered separately.

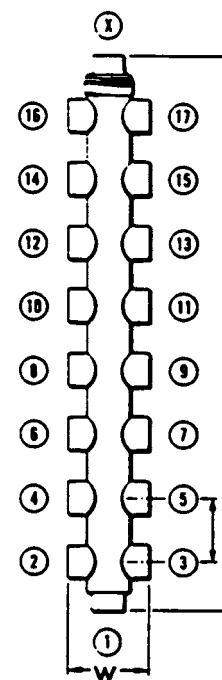

MOLE™ DIMENSIONS

“W” Dimension: 4-1/2”
Center-to-Center distance between outlets: 3-1/2”

OUTLET RANGE: “A” 6 Str. - 600 kcmil
“B” 2 Str. - 1000 kcmil

Catalog Number	Ampere Capacity	End ⓐ + (X)*	Other	Qty of Outlets	Length “L” Inches
ZMX415	1500	A	A	4	6
ZMX615				6	9
ZMX815				8	12
ZMX1015				10	15
ZMX1215				12	18
ZMX1415				14	21
ZMX1615				16	24
ZMX1815				18	27
ZMX425	2500	A	A	4	6.5
ZMX625				6	10
ZMX825				8	13.5
ZMX1025				10	17
ZMX1225				12	20.5
ZMX1425				14	24
ZMX1625				16	27.5
ZMX1825				18	31
ZMX430	3000	A	A	4	6.5
ZMX630				6	10.1
ZMX830				8	13.5
ZMX1030				10	16.9
ZMX1230				12	20.3
ZMX1430				14	23.6
ZMX1630				16	27
ZMX1830				18	30.4

Catalog Number	Ampere Capacity	End ⓐ + (X)*	Other	Qty of Outlets	Length “L” Inches
ZMX425B	2500	B	B	4	6.5
ZMX625B				6	10
ZMX825B				8	13.5
ZMX1025B				10	17
ZMX1225B				12	20.5
ZMX1425B				14	24
ZMX1625B				16	27.5
ZMX1825B				18	31
ZMX430B	3000	B	B	4	6.5
ZMX630B				6	10.1
ZMX830B				8	13.5
ZMX1030B				10	16.9
ZMX1230B				12	20.3
ZMX1430B				14	23.6
ZMX1630B				16	27
ZMX1830B				18	30.4



*Add Suffix “A4” to Change End Outlet ⓐ to Size B
*Add Suffix “A7” to Change End Outlet ⓐ to Size C
Contact Customer Service for Additional Outlet Configurations.

MOLE™ Stud Connector Type ZMLDN
For Connecting Copper Cables to Network Protector

To terminate one or more cables at the studs of distribution transformers, network protectors, or other apparatus. The body, except for the clamping element, is completed insulated. A separate clamping cap over the stud is provided that permits easy removal of the MOLE™ Stud Connector. This permits work to be done on the Network Protector without unduly disturbing the cables.

Outlet Plugs — MOLE™ outlet plugs that facilitate sealing outlets not being used are available. Type Z-P and Type K-P, sold separately.

Insulating Sleeves — Taping operations for watertight joints are greatly simplified by the use of BURNDY® Type CM or MOLE™ Insulating Sleeves Type Z-C, sold separately.

Clamping Elements — Outlet Symbols A or B, refer to socket and nut Type Z-NR, and Cone Type Z cable clamping elements accommodated. These must be ordered separately.

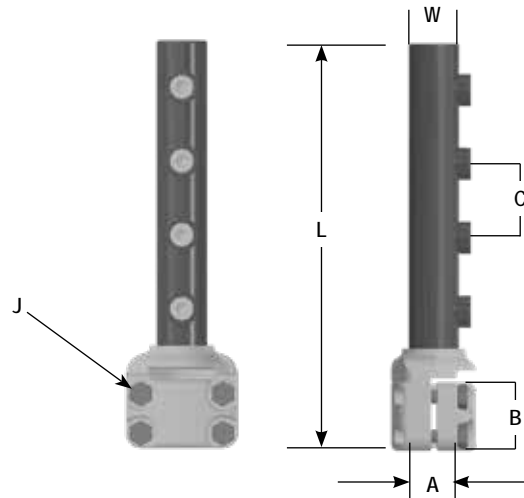

OUTLET RANGE: "A" 6 Str. - 600 kcmil
"B" 2 Str. - 1000 kcmil

Catalog Number	Ampere Capacity	Cable Outlet Arrangement	* No. of Outlets	A		Dimensions in Inches					
				Stud Dia.	Threads per Inch	B	C	J	L	W	
ZMLDN115	1500	All Outlets A	1	1-1/2	12	2.69	—	1/2	8.56	1.94	
ZMLDN215			2	1-1/2	12	2.69	3	1/2	11.56	1.94	
ZMLDN315			3	1-1/2	12	2.69	3	1/2	14.56	1.94	
ZMLDN415			4	1-1/2	12	2.69	3	1/2	17.56	1.94	
ZMLDN515			5	1-1/2	12	2.69	3	1/2	20.56	1.94	
ZMLDN615			6	1-1/2	12	2.69	3	1/2	23.56	1.94	
ZMLDN120	2000		All Outlets B	1	1-1/2	12	2.69	—	1/2	9.06	2.38
ZMLDN220				2	1-1/2	12	2.69	3-1/2	1/2	12.56	2.38
ZMLDN320				3	1-1/2	12	2.69	3-1/2	1/2	16.06	2.38
ZMLDN420				4	1-1/2	12	2.69	3-1/2	1/2	19.56	2.38
ZMLDN520				5	1-1/2	12	2.69	3-1/2	1/2	23.06	2.38
ZMLDN620				6	1-1/2	12	2.69	3-1/2	1/2	26.56	2.38
ZMLDN120B		1		1-1/2	12	2.69	—	1/2	7-7/8	2.38	
ZMLDN220B		2		1-1/2	12	2.69	3-1/2	1/2	11-3/8	2.38	
ZMLDN320B		3		1-1/2	12	2.69	3-1/2	1/2	14-7/8	2.38	
ZMLDN420B		4		1-1/2	12	2.69	3-1/2	1/2	18-3/8	2.38	
ZMLDN520B		5		1-1/2	12	2.69	3-1/2	1/2	21-7/8	2.38	
ZMLDN620B		6		1-1/2	12	2.69	3-1/2	1/2	25-3/8	2.38	

* Can be furnished with more than 6 outlets.

MOLE™ Stud Connector Type ZMLDN (Continued)

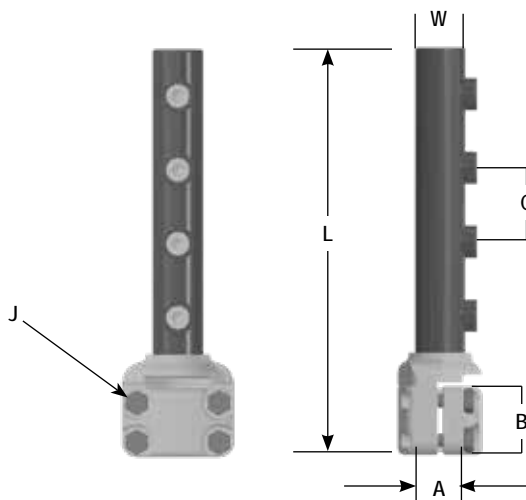

OUTLET RANGE: "A" 6 Str. - 600 kcmil
"B" 2 Str. - 1000 kcmil

Catalog Number	Ampere Capacity	Cable Outlet Arrangement	* No. of Outlets	A		Dimensions in Inches				
				Stud Dia.	Threads per Inch	B	C	J	L	W
ZMLDN125	2500	All Outlets A	1	3	12	3-1/4	—	5/8	8-27/32	3-7/16
ZMLDN225			2	3	12	3-1/4	3-1/2	5/8	12-11/32	3-7/16
ZMLDN325			3	3	12	3-1/4	3-1/2	5/8	15-27/32	3-7/16
ZMLDN425			4	3	12	3-1/4	3-1/2	5/8	19-11/32	3-7/16
ZMLDN525			5	3	12	3-1/4	3-1/2	5/8	22-27/32	3-7/16
ZMLDN625			6	3	12	3-1/4	3-1/2	5/8	26-11/32	3-7/16
ZMLDN125B		All Outlets B	1	3	12	3-1/4	—	5/8	8-27/32	3-7/16
ZMLDN225B			2	3	12	3-1/4	3-1/2	5/8	12-11/32	3-7/16
ZMLDN325B			3	3	12	3-1/4	3-1/2	5/8	15-27/32	3-7/16
ZMLDN425B			4	3	12	3-1/4	3-1/2	5/8	19-11/32	3-7/16
ZMLDN525B			5	3	12	3-1/4	3-1/2	5/8	22-27/32	3-7/16
ZMLDN625B			6	3	12	3-1/4	3-1/2	5/8	26-11/32	3-7/16
ZMLDN130	3000	All Outlets A	1	3	12	3-1/4	—	5/8	7-5/8	4
ZMLDN230			2	3	12	3-1/4	3-3/8	5/8	11-1/4	4
ZMLDN330			3	3	12	3-1/4	3-3/8	5/8	14-5/8	4
ZMLDN430			4	3	12	3-1/4	3-3/8	5/8	18	4
ZMLDN530			5	3	12	3-1/4	3-3/8	5/8	21-3/8	4
ZMLDN630			6	3	12	3-1/4	3-3/8	5/8	24-3/4	4
ZMLDN130B		All Outlets B	1	3	12	3-1/4	—	5/8	7-5/8	4
ZMLDN230B			2	3	12	3-1/4	3-3/8	5/8	11-1/4	4
ZMLDN330B			3	3	12	3-1/4	3-3/8	5/8	14-5/8	4
ZMLDN430B			4	3	12	3-1/4	3-3/8	5/8	18	4
ZMLDN530B			5	3	12	3-1/4	3-3/8	5/8	21-3/8	4
ZMLDN630B			6	3	12	3-1/4	3-3/8	5/8	24-3/4	4

* Can be furnished with more than 6 outlets. For outlet combinations not listed call customer service.

MOLE™ Stud Connector Type Z2MLDN
For Connecting Copper Cables to Network Protector

To terminate two or more cables at the studs of distribution transformers, network protectors, or other apparatus. The body, except for the clamping element, is completed insulated. A separate clamping cap over the stud is provided that permits easy removal of the MOLE™ Stud Connector. This permits work to be done on the Network Protector without unduly disturbing the cables.

Outlet Plugs — MOLE™ outlet plugs that facilitate sealing outlets not being used are available. Type Z-P and Type K-P, sold separately.

Insulating Sleeves — Taping operations for watertight joints are greatly simplified by the use of BURNDY® Type CM or MOLE™ Insulating Sleeves Type Z-C, sold separately.

Clamping Elements — Outlet Symbols A or B, refer to socket and nut Type Z-NR, and Cone Type Z cable clamping elements accommodated. These must be ordered separately.

OUTLET RANGE: **"A" 6 Str. - 600 kcmil**
 "B" 2 Str. - 1000 kcmil

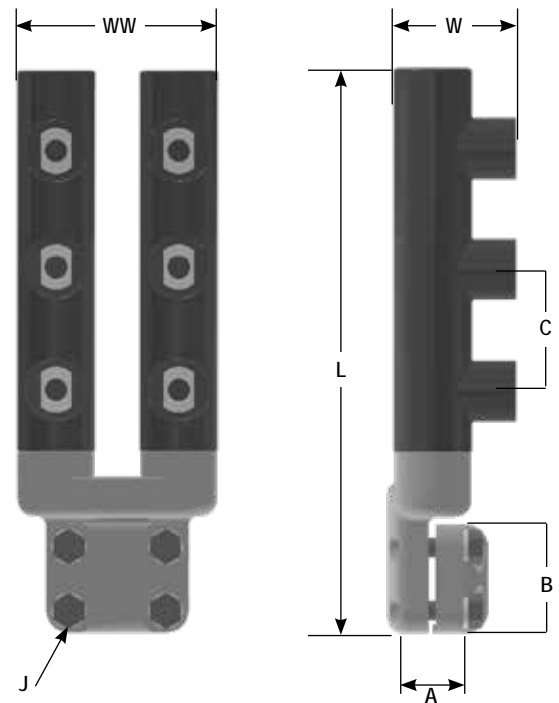

Catalog Number	Ampere Capacity	Cable Outlet Arrangement	*No. of Outlets	A		Dimensions in Inches					
				Stud Dia.	Threads per Inch	B	C	J	L	W	WW
Z2MLDN20	2000 & Smaller	All Outlets A	2	1-1/2	12	2-11/16	—	1/2	8	3	5-3/16
Z2MLDN40			4	1-1/2	12	2-11/16	3	1/2	11	3	5-3/16
Z2MLDN620			6	1-1/2	12	2-11/16	3	1/2	14	3	5-3/16
Z2MLDN230	2500 & 3000	All Outlets A	2	3	12	3-1/4	—	5/8	9	3	6-1/2
Z2MLDN430			4	3	12	3-1/4	3	5/8	12	3	6-1/2
Z2MLDN630			6	3	12	3-1/4	3	5/8	15	3	6-1/2
Z2MLDN230B		All Outlets B	2	3	12	3-1/4	—	5/8	9	3-1/2	6-1/2
Z2MLDN430B			4	3	12	3-1/4	3-1/2	5/8	12-1/2	3-1/2	6-1/2
Z2MLDN630B			6	3	12	3-1/4	3-1/2	5/8	16	3-1/2	6-1/2

*Can be furnished with more than 6 outlets. For outlet combinations not listed call customer service.

MOLE™ Stud Connector Type ZMDN For Connecting Copper Cables to Network Protector

To terminate one or more cables at the studs of distribution transformers, network protectors, or other apparatus. The body, except for the clamping element, is completed insulated. A separate clamping cap over the stud is provided that permits easy removal of the MOLE™ Stud Connector. This permits work to be done on the Network Protector without unduly disturbing the cables.

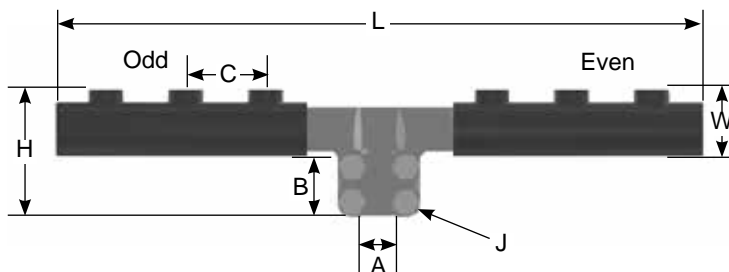

Outlet Plugs — MOLE™ outlet plugs that facilitate sealing outlets not being used are available. Type Z-P and Type K-P, sold separately.

Insulating Sleeves — Taping operations for watertight joints are greatly simplified by the use of BURNDY® Type CM or MOLE™ Insulating Sleeves Type Z-C, sold separately.

Clamping Elements — Outlet Symbols A or B, refer to socket and nut Type Z-NR, and Cone Type Z cable clamping elements accommodated. These must be ordered separately.

OUTLET RANGE: **"A" 6 Str. - 600 kcmil**
 "B" 2 Str. - 1000 kcmil

Catalog Number	Ampere Capacity	Cable Outlet Arrangement	*No. of Outlets	A		Dimensions in Inches					
				Stud Dia.	Threads per Inch	B	C	J	H	L	W
ZMDN320	2000 & Smaller	All Outlets A	3	1-1/2	12	2-11/16	3-1/2	1/2	8-1/16	11-1/2	3-7/16
ZMDN420			4	1-1/2	12	2-11/16	3-1/2	1/2	8-1/16	15	3-7/16
ZMDN520			5	1-1/2	12	2-11/16	3-1/2	1/2	8-1/16	18-1/2	3-7/16
ZMDN620			6	1-1/2	12	2-11/16	3-1/2	1/2	8-1/16	22	3-7/16
ZMDN320B		All Outlets B	3	1-1/2	12	2-11/16	3-1/2	1/2	8-1/16	11-1/2	3-7/16
ZMDN420B			4	1-1/2	12	2-11/16	3-1/2	1/2	8-1/16	15	3-7/16
ZMDN520B			5	1-1/2	12	2-11/16	3-1/2	1/2	8-1/16	18-1/2	3-7/16
ZMDN620B			6	1-1/2	12	2-11/16	3-1/2	1/2	8-1/16	22	3-7/16
ZMDN325	2000 Through 2500	All Outlets A	3	3	12	3-1/4	3-1/2	5/8	8-5/8	11-1/2	3-7/16
ZMDN425			4	3	12	3-1/4	3-1/2	5/8	8-5/8	15	3-7/16
ZMDN525			5	3	12	3-1/4	3-1/2	5/8	8-5/8	18-1/2	3-7/16
ZMDN625			6	3	12	3-1/4	3-1/2	5/8	8-5/8	22	3-7/16

*Can be furnished with more than 6 outlets. For outlet combinations not listed call customer service.
For connectors with an odd number of outlets the odd and even split of outlets will be as indicated in the diagram.

MOLE™ Stud Connector Type ZMTDN

For Connecting Copper Cables to Network Protector

To terminate two or more cables at the studs of distribution transformers, network protectors, or other apparatus. The body, except for the clamping element, is completed insulated. A separate clamping cap over the stud is provided that permits easy removal of the MOLE™ Stud Connector. This permits work to be done on the Network Protector without unduly disturbing the cables.



Catalog Number	Ampere Capacity	Number of Outlets	Cable Outlet Arrangement	Stud Dia. (12 threads/inch)
ZMTDN815	1500	8	A	1.50"
ZMTDN1015	1500	10	A	1.50"
ZMTDN820	2000-2500	8	A	1.50"
ZMTDN1025	2000-2500	10	A	3.00"

MOLE™ Outlet Plugs, Type Z-P

For MOLE™ Outlets not in use

These outlet plugs facilitate sealing MOLE™ outlets not currently being used.

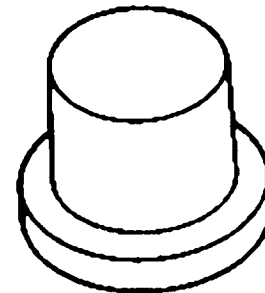

Catalog Number	Used On Outlet Size
Z29P	A
Z34P	B
Z40P	C

Socket and Nut Assembly Type Z-NR

For Use with MOLE™

Designed for use with the BURNDY® MOLE™ connectors. With the use of the proper compression cones, 14 sizes take a range of cables from #6 to 1000 kcmil. The compact design helps in easy, effective taping. Insulating sleeves are available to keep taping to a minimum.

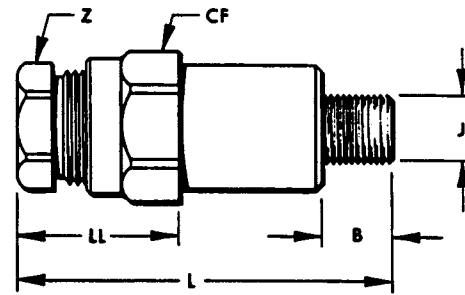

OUTLET RANGE: “A” 6 Str. - 600 kcmil
 “B” 2 Str. - 1000 kcmil

Catalog Number	To be Used in MOLE™ Outlet Size	Maximum Cable Accommodated by Socket	Stud Size J	Dimensions in Inches				
				B	CF (Cross Flats)	L	LL	Z (Cross Flats)
Z28NR	A	4/0 Str.	5/8-18	17/32	1-1/8	3-7/16	1-1/2	7/8
Z29NR		250 kcmil	5/8-18	17/32	1-3/16	3-9/16	1-5/8	15/16
Z30NR		300 kcmil	5/8-18	17/32	1-1/4	3-5/8	1-11/16	1
Z32NR		400 kcmil	5/8-18	17/32	1-3/8	3-5/8	1-11/16	1-1/8
Z34NR		500 kcmil	5/8-18	17/32	1-1/2	3-11/16	1-3/4	1-1/4
Z36NR		600 kcmil	5/8-18	17/32	1-1/2	3-13/16	1-7/8	1-5/16
Z40NRA ①	B	800 kcmil	5/8-18	17/32	1-13/16	5-17/32	2-1/4	1-1/2
Z34NRB ②		500 kcmil	7/8-14	11/16	1-1/2	3-11/16	1-3/4	1-1/4
Z40NR		800 kcmil	7/8-14	11/16	1-13/16	4-3/8	2-1/4	1-1/2
Z44NR		1000 kcmil	7/8-14	11/16	1-15/16	6-1/16	2-7/16	1-5/8
Z46NR	C	1500 kcmil	1-1/8-12	13/16	2-1/8	6-7/8	2-13/16	2-1/4
Z47NR		1750 kcmil	1-1/8-12	13/16	2-1/4	7-3/16	2-7/8	2-3/8

① Uses Insulating Sleeve Z104C4434

② Uses Insulating Sleeve Z88C3429

MOLE™ Compression Cone Type Z
For Concentric and Compressed Conductor

For use with Socket and Nut Assembly, the Z Cone is machined to close tolerances to provide maximum secureness in gripping a wide range of cable sizes. Annular grooves in the inner barrel of the cone serve to further accomplish this result.

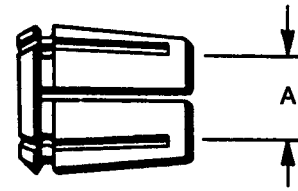

Catalog Number	Cable Size	For Use with Socket & Nut Assembly	A	
			Inches	
Z6C28	#6 Str.	Z28NR	0.18 in	
Z4C28	#4 Str.		0.23 in	
Z2C28	#2 Str.		0.29 in	
Z2528	1/0 Str.		0.37 in	
Z2728	3/0 Str.		0.47 in	
Z2828	4/0 Str.		0.53 in	
Z6C29	#6 Str.		Z29NR	0.18 in
Z4C29	#4 Str.	0.23 in		
Z2C29	#2 Str.	0.29 in		
Z1C29	#1 Str.	0.33 in		
Z2529	1/0 Str.	0.37 in		
Z2629	2/0 Str.	0.42 in		
Z2829	4/0 Str.	0.53 in		
Z2929	250 kcmil	0.58 in		
Z6C30	#5 Str.	Z30NR		0.18 in
Z4C30	#4 Str.			0.23 in
Z2C30	#2 Str.		0.29 in	
Z1C30	#1 Str.		0.33 in	
Z2530	1/0 Str.		0.37 in	
Z2630	2/0 Str.		0.42 in	
Z2730	3/0 Str.		0.47 in	
Z2830	4/0 Str.		0.53 in	
Z2930	250 kcmil		0.58 in	
Z3030	300 kcmil		0.63 in	
Z2C32	#2 Str.		Z32NR	0.29 in
Z1C32	#1 Str.			0.33 in
Z2532	1/0 Str.			0.37 in
Z2632	2/0 Str.	0.42 in		
Z2732	3/0 Str.	0.47 in		
Z2832	4/0 Str.	0.53 in		
Z2932	250 kcmil	0.58 in		
Z3032	300 kcmil	0.63 in		
Z3132	350 kcmil	0.68 in		
Z3232	400 kcmil	0.73 in		
Z2C34	#2 Str.	Z34NR & Z34NRB	0.29 in	
Z1C34	#1 Str.		0.33 in	
Z2534	1/0 Str.		0.37 in	
Z2634	2/0 Str.		0.42 in	
Z2734	3/0 Str.		0.47 in	

Catalog Number	Cable Size	For Use with Socket & Nut Assembly	A
			Inches
Z2834	4/0 Str.	Z34NR & Z34NRB	0.53 in
Z2934	250 kcmil		0.58 in
Z3034	300 kcmil		0.63 in
Z3134	350 kcmil		0.69 in
Z3234	400 kcmil		0.73 in
Z3334	450 kcmil		0.76 in
Z3434	500 kcmil		0.81 in
Z2936	250 kcmil	Z36NR	0.58 in
Z3036	300 kcmil		0.63 in
Z3136	350 kcmil		0.69 in
Z3236	400 kcmil		0.73 in
Z3336	450 kcmil		0.76 in
Z3436	500 kcmil		0.81 in
Z3536	550 kcmil		0.86 in
Z3636	600 kcmil		0.89 in
Z2940	250 kcmil	Z40NR & Z40NRA	0.58 in
Z3040	300 kcmil		0.63 in
Z3140	350 kcmil		0.69 in
Z3240	400 kcmil		0.73 in
Z3340	450 kcmil		0.76 in
Z3440	500 kcmil		0.81 in
Z3540	550 kcmil		0.86 in
Z3640	600 kcmil		0.89 in
Z3740	650 kcmil		0.92 in
Z3840	700 kcmil		0.97 in
Z3940	750 kcmil	1.00 in	
Z4040	800 kcmil	1.03 in	
Z3444	500 kcmil	Z44NR	0.81 in
Z3544	550 kcmil		0.86 in
Z3644	600 kcmil		0.89 in
Z3744	650 kcmil		0.92 in
Z3844	700 kcmil		0.97 in
Z3944	750 kcmil		1.00 in
Z4044	800 kcmil		1.03 in
Z4144	850 kcmil		1.06 in
Z4244	900 kcmil		1.09 in
Z4344	950 kcmil		1.12 in
Z4444	1000 kcmil	1.15 in	
Z4646	1500 kcmil	Z46NR	1.41 in
Z4747	1750 kcmil	Z47NR	1.53 in

MOLE™ Compression Cone Type Z For Compact Conductor

For use with Socket and Nut Assembly, the Z Cone is machined to close tolerances to provide maximum secureness in gripping a wide range of cable sizes. Annular grooves in the inner barrel of the cone serve to further accomplish this result.

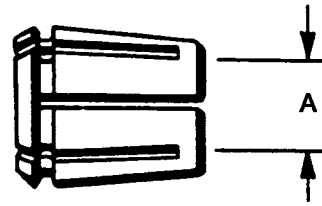

Compact Stranded Copper Cable			
Type Z Cone	Socket and Nut Assembly	Compact Cable Size	Nominal Conductor Diameter
Z3C28	Z28NR	#2	0.268
Z2C28		#1	0.299
Z1C28		1/0	0.336
Z2528		2/0	0.376
Z2628		3/0	0.423
Z2728		4/0	0.475
Z2C29		Z29NR	#1
Z1C29	1/0		0.336
Z2529	2/0		0.376
Z2629	3/0		0.423
Z2729	4/0		0.475
Z2829	250 kcmil		0.520
Z2929	300 kcmil		0.570
Z1C30	Z30NR	1/0	0.336
Z2530		2/0	0.376
Z2630		3/0	0.423
Z2730		4/0	0.475
Z2830		250 kcmil	0.520
Z2930		300 kcmil	0.570
Z1C32		Z32NR	1/0
Z2532	2/0		0.376
Z2632	3/0		0.423
Z2732	4/0		0.475
Z2832	250 kcmil		0.520
Z2932	300 kcmil		0.570
Z3232	500 kcmil		0.736
Z2534	Z34NR	2/0	0.376
Z2634		3/0	0.423
Z2734		4/0	0.475
Z2834		250 kcmil	0.520
Z2934		300 kcmil	0.570
Z3234		500 kcmil	0.736
Z3334		550 kcmil	0.775
Z3434	600 kcmil	0.813	

Compact Stranded Copper Cable				
Type Z Cone	Socket and Nut Assembly	Compact Cable Size	Nominal Conductor Diameter	
Z2536	Z36NR	2/0	0.376	
Z2636		3/0	0.423	
Z2736		4/0	0.475	
Z2836		250 kcmil	0.520	
Z2936		300 kcmil	0.570	
Z3236		500 kcmil	0.736	
Z3336		550 kcmil	0.775	
Z3436		600 kcmil	0.813	
Z3636		750 kcmil	0.908	
Z2640		Z40NR	3/0	0.423
Z2740	4/0		0.475	
Z2840	250 kcmil		0.520	
Z2940	300 kcmil		0.570	
Z3240	500 kcmil		0.736	
Z3340	550 kcmil		0.775	
Z3440	600 kcmil		0.813	
Z3640	750 kcmil		0.908	
Z2844	Z44NR		250 kcmil	0.520
Z2944			300 kcmil	0.570
Z3244		500 kcmil	0.736	
Z3344		550 kcmil	0.775	
Z3444		600 kcmil	0.813	
Z3644		750 kcmil	0.908	

MOLE™ Coupler, Type ZMS
 For Connecting Multiple MOLE™ Connectors

A compact, easy-to-tape MOLE™ Coupler for joining multiple MOLE™ end-to-end. Allows for expansion of underground systems by joining more MOLE™ Connectors to existing MOLE™ installations. Easy assembled to the end outlets of MOLE™ Connectors Types ZMT, ZMX, ZML, and ZMK. Can also be used in side outlets for other types of MOLE™ arrangements. The MOLE™ Coupler has a lock nut feature which permits pre-positioning of the added MOLE™ and facilitates training of new cables. Makes an effective electrical and mechanical connection.

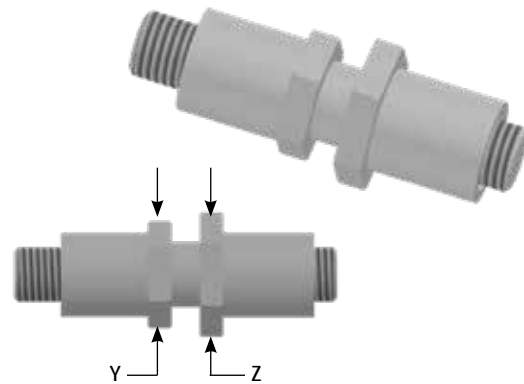

OUTLET RANGE: **“A” (5/8”) 6 Str. - 600 kcmil**
 “B” (7/8”) 2 Str. - 1000 kcmil
 “C” (1-1/8”) 500 - 1500 kcmil

MOLE™ Outlet Size	MOLE™ Coupler	MOLE™ Coupler Ampere Capacity	Dimensions in Inches		
			Overall Length	Cross Flats	
				Y	Z
A	ZMS29	1200	4-21/32	1-3/16	1-3/8
B	ZMS34	1600	5-7/32	1-1/2	1-3/4
C	ZMS40	2000	5-3/4	1-3/4	2-1/8

MOLE™ Outlet Insulating Sleeve, Type Z-C
 Aid in insulating MOLE™ Outlets to produce watertight joint with minimal taping

An effective aid in insulating MOLE™ outlets to produce a secure watertight joint with a minimum of taping. Fits over the MOLE™ outlet and over the maximum outer diameter of insulated cable. The difference between the I.D. of the standard sleeve and the O.D. of the cable insulation is taken up by wrapping the cable with several turns of rubber tape. The only external taping required to effectively seal the joint is the small area at each end of the sleeve.

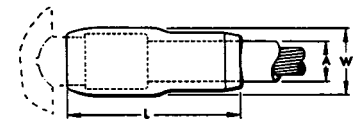

Fig. 1

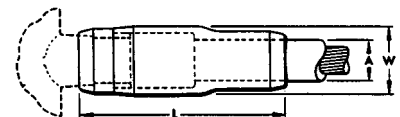

Fig. 2

Catalog Number	For Use with Socket and Nut Assemblies	Fig. No.	Dimensions in Inches		
			*A (Max.)	L	W
Z72C3029	Z28NR Z29NR Z30NR	1	1-1/8	4-3/4	1-7/8
Z88C3429	Z32NR Z34NR Z34NRB Z36NR	1	1-3/8	5-3/16	2-1/8
Z104C4034	Z40NR	1	1-5/8	5-13/16	3-5/6
Z104C4434	Z44NR Z40NRA	2	1-5/8	7-3/16	3-5/6
Z144C4840	Z45NR Z46NR Z47NR Z48NR	2	2-1/4	9-5/16	3-1/2

* Build up insulation of MOLE™ Joint with rubber tape to equal inner diameter of Insulating Sleeve, for insulating sleeve with inner diameter other than standard call customer service.

This page intentionally left blank

HYCRAB™ Connectors

One of the most economical devices for connecting several cables to a common junction point is the HYCRAB™, which is essentially a bus bar with a number of compression-type connector outlets, pre-insulated to eliminate taping. Like the MOLE™, the HYCRAB™ fits into a limited space, is simple to rack, and facilitates adding future cables.

Insert and Insulation

Having an insert similar to that of the MOLE™, the HYCRAB™, has connector outlets of the BURNDY® HYDENT™ compression type. These tubular elements are indented to the cable by BURNDY® HYPRESS™ installation tools and dies, designed to compress connector and cable together with indents of controlled depth. HYDENT™ compression connections are made quickly and easily, have relative conductivities of 100% or higher, are electrically stable, and mechanically secure.

The HYCRAB™ is insulated by a jacket of molded rubber to resist prolonged exposure to oil or other contaminants.

Installation

Insulation fingers are rolled back to expose the tubular outlets, sufficiently spaced to allow for the convenient operation of BURNDY® HYPRESS™ compression tools. Cable ends are inserted into the outlets. Each is crimped with one or two indents, and the fingers are rolled forward again to cover the outlets. Installation is completed by tapping the short space between the tip of the finger and cable insulation.

Variations and Accessories

Uninsulated HYCRAB™ connectors for joining bare neutral cables are available in the same range of sizes and number of outlets as the insulated HYCRAB™. By using reducing adapters, the HYCRAB™ can accommodate service wires as small as #6, in addition to the 4/0 or 500 kcmil cable sizes for which these connectors are ordinarily used.

Type YM Insulated HYCRAB™

A compact insulated crab joint for connecting underground cables at junction points. Two outlets, one on either side of the HYCRAB™ body, are ready for immediate use. All other outlets are sealed with vulcanized rubber plugs which are easily removed when future installations are made. This unit eliminates bulky, difficult crotch taping. By using Reducing Adapters (Type Y-R), the HYCRAB™ can be installed on cable sizes from #6 to 500 kcmil (e.g.: use Y3428R to install 4/0 into YM4-34).

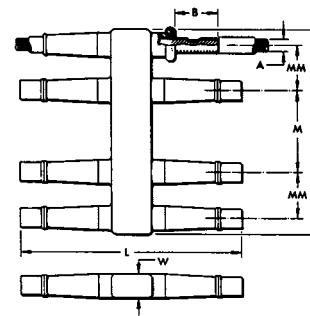

Catalog Number	Cable Size A	# of Outlets	Dimension in Inches						Installation Information	
									HYPRESS™ & Indentor Die	# of Indents
			Y34BH with Y34PR							
			Nest Die							
B	H	L	M	MM	W					
YM428	4/0 Str.	4	2	3-11/16	10-3/16	—	2-3/16	1-1/8	B28D	1
YM628		6	2	7-9/16	10-3/16	3-7/8	2-3/16	1-1/8	B28D	1
YM828		8	2	9-3/4	10-3/16	3-7/8	2-3/16	1-1/8	B28D	1
YM1028		10	2	13-1/2	8-3/4	3-1/2	2-1/2	1-1/8	B28D	1
YM1228		12	2	16	8-3/4	3-1/2	2-1/2	1-1/8	B28D	1
YM434	500 kcmil	4	2-1/2	4-3/8	12-5/8	—	2-3/8	1-1/2	No Nest Die Required. Use Indentor Only.	2
YM634		6	2-1/2	8-5/8	12-5/8	4-1/4	2-3/8	1-1/2		2
YM834		8	2-1/2	11	12-5/8	4-1/4	2-3/8	1-1/2		2
YM1034		10	2-1/2	14-1/2	12-1/2	3-3/4	2-1/2	1-1/2		2
YM1234		12	2-1/2	17	12-1/2	3-3/4	2-1/2	1-1/2		2

HYCRAB™ Connector, Type ZNM For Joining Bare Neutral Cables

A compact uninsulated multiple connector for joining bare neutral underground cables. For insulated crab joints, see HYCRAB™, Type YM. Reducing adapters (Type Y-R) permit the HYCRAB™ products listed below to take a full range of cable sizes from #6 to 500 kcmil. For proper installation see table below.

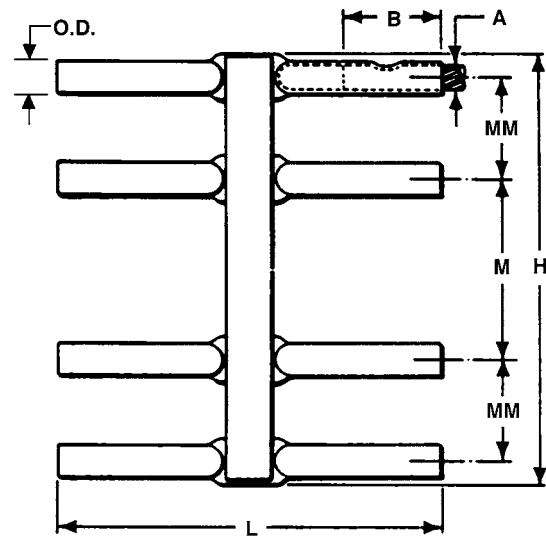

Catalog Number	Cable Size A	No. of Outlets	Dimension in Inches						Installation Information	
									HYPRESS™ & Indentor Die	No. of Indents
			Y34BH with Y34PR	Nest Die						
B	H	L	M	MM	O.D.					
YNM428	4/0 Str.	4	2	3-3/16	8-3/16	—	2-3/16	11/16	B28D	1
YNM628		6	3-1/8	7-1/6	8-3/16	3-7/8	2-3/16	11/16	B28D	1
YNM828		8	2	9-1/4	8-3/16	3-7/8	2-3/16	11/16	B28D	1
YNM434	500 kcmil	4	2-1/2	3-15/16	10-5/8	—	2-3/8	1-1/16	No Nest Die Required. Use Indentor Only.	2
YNM634		6	2-1/2	8-3/16	10-5/8	4-1/4	2-3/8	1-1/16		2
YNM834		8	2-1/2	10-9/16	10-5/8	4-1/4	2-3/8	1-1/16		2

* Bare HYCRAB™ can be furnished to accommodate both 4/0 and 500 kcmil cables.

Network Protection

The primary purpose of network protection is the controlled interruption of fault currents before damage occurs to cable insulations and associated equipment, and the elimination of unnecessary service interruptions. The limiter and fuses for network protection are closely associated with the connectors and are equally vital to the safe, continuous operation of an underground system.

BURNDY has developed protective devices that have played a major role in reducing underground system outages and the subsequent expenses incurred in the loss of service and replacement of damaged cables. A basic objective has been the design of limiter-connector combinations that, in addition to protecting against the effects of fault currents, economize on both space and installation costs.

Limiters are designed to protect underground secondary cable from damage by fault currents of two principal kinds: high energy arcing faults and sustained faults. The arcing fault, usually of shorter duration and lesser intensity, is more common. While this type of fault may sputter briefly and then clear, some may be sustained long enough to "roast" the insulation.

A sustained fault occurs when two conductors come solidly into contact and permit the flow of heavy short-circuit currents. Without suitable protection, these fault currents are heavy enough to damage cable insulation and often produce combustible fumes accompanied by fire and explosion.

Installed at each end of cable sections, limiters have time-current characteristics designed to avoid unnecessary outages. Network protector fuses, installed in the network protector on the load side of the breaker, provide back-up protection against failure of a network protector to open on a primary fault. Coordinated characteristics of limiters and fuses provide for fault currents to be interrupted before they can cause damage, but only under predetermined time-current conditions, and only in those parts of the system where interruption is necessary.

Limiters

Engineered to interrupt the circuit before cables carrying a fault current are usually damaged, limiters act to confine damage to the section of cable where the fault occurred. The limiters are designed to prevent unnecessary clearing and will "hang on" during:

1. Faults with wold clear without damaging cable insulation
2. Overloads from motor starting, load transfer because of primary fault, or temporary overload during fault conditions
3. Overloads from loss of secondary conductors caused by clearing of other limiters
4. Reverse current flow through the network protector on primary faults
5. Faults on other secondary cables

For proper proection BURNDY® limiters are designed with time-current characteristics approximating the insulation damage curve of the cable with which they will be used. Figure 4 shows time-current characteristic curves for a range of standard (250 volt) limiters, superimposed on insulation damage curves for several cable sizes. Although the limiter curve crosses the insulation damage curves, in practice the limiters will blow before the insulation can deteriorate.

The insulation damage characteristics represent three phases equally loaded in a duct. Since low-current faults seldom affect more than one phase at a time, the rate of heat generated in the conduit is much less than for a balanced 3-phase fault, and the time to reach the damage point is appreciably longer. Practical experience confirms that limiters provide protection during low-current, as well as high-current faults.

Construction

The limiter is essentially a compression-type electrical connector with its center section accurately formed to provide a fusible element. This fusible element is enclosed in a molded ceramic shell and the assembly encased in an insulated sleeve.

Interrupting capacities are as follows:

Standard Limiters: 30,000 amps at 250V

Replaceable-Link Limiters: 20,000 amps at 250V

The protection probably lies in the fact that the fault impedance reduces the actual fault current to a value considerably less than calculated.

Replaceable-Link Limiters

Replaceable-link limiters, which provide faster time-current characteristics (Figure 5), are used in smaller networks, on the fringes of larger networks, at points where radial feeders leave a network, and for fusing service cables. As its name implies, this limiter is also distinctive in that its fusible link is replaceable.

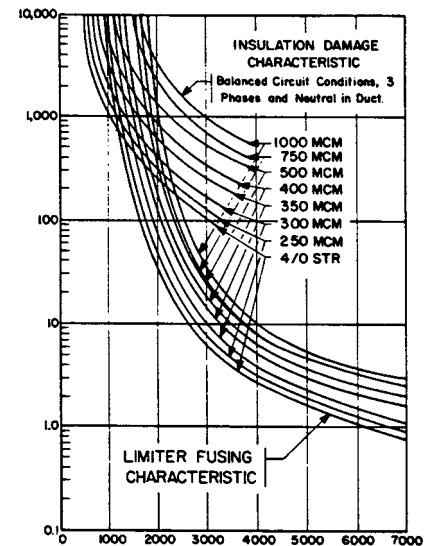

Figure 4: Current - Amperes Standard 250 Volt Limiters

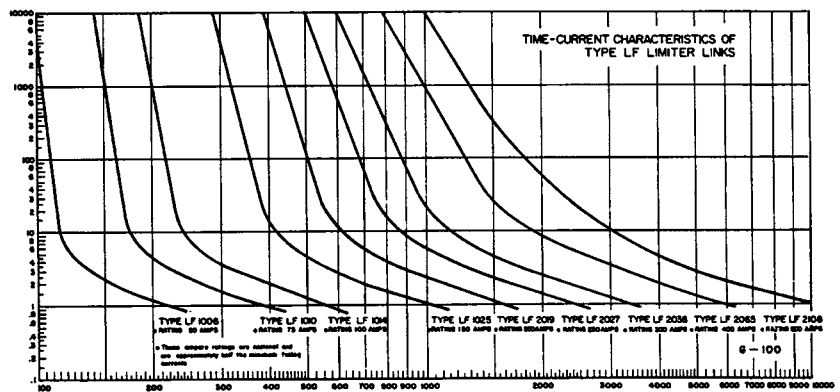

Figure 5: Current in Amperes Replaceable-link Limiters

Network Protection (Continued)

Limiter Variations

The Limiter Lug provides a fusible connection between a cable and a flat surfaced terminal of a transformer or other apparatus. The Limiter Tap incorporates a Limiter Lug assembly, modified to terminate cable to a ring bus. This straight Limiter is made for installation in a single conductor cable. The Molimiter is a Limiter designed so that one end is crimped onto a cable and the other fits the clamping element of a MOLE™ outlet. The Limiter HYCRAB™ connector is essentially a HYCRAB™ with a fusible section in each of its outlets.

Network Protector Fuses

Type Y and Z Network Protector Fuses provide back-up protection in case the protector breaker fails to operate during a primary fault. The fuse time-current curves (Figure 7), are similar to those of the limiter, thus permitting correct fuse-limiter coordination for complete network protection.

Design and Construction

The fusible element for a Type Y or Type Z Fuse is a tin-plated copper bar with reduced section, encased in an arc-resistant molded ceramic enclosure. One-piece construction eliminates possibility of joint failure and assures maximum reliability.

Limiter-Fuse Coordination

To isolate a fault before it can cause extensive damage, and without interrupting service in other sections of the network, limiters and fuses must clear at the proper time and in proper sequence, depending on the fault's location in the primary or secondary system. When a primary fault occurs, the fuse should clear before any

limiters blow. For a secondary fault, limiters should clear the fault before the network protector fuse opens. Failure of limiters and network protector fuses to function in proper sequence could cause cascading of other Fuses, or clearing of secondary faults by Fuses rather than limiters. Premature blowing of Limiters not in the faulted section could cause unnecessary service interruption in sections remote from the fault.

To assure the coordinated functioning of fuses and limiters throughout a system, proper rating must be selected. The four-step "Coordination Study" (Figure 8) used in a 4-parallel cable feed system from the protector to the first secondary junction is a typical example of how to select proper ratings.

1. Plot the damage characteristic curve of the cable insulation in the system. Curves for Class L620 (260° C or 500° F), appear in Figure 5.
2. Plot the time-current characteristic curve of the same limiter in Parallel secondary mains, assuming it carries 40% of total backfeed current. Allowing for the possibility of unequal current distribution of secondary mains, the "40% Cable Limiter Curve" provides a conservative basis for selection of network protector fuses.
3. Select a fuse with its time-current characteristics (Figure 7) lying between the limiter curves plotted in steps 2 and 3.

This procedure avoids the selection of fuses so light that they might overheat the network protector or clear unnecessarily, possibly cascading other fuses in the network; or so heavy that transformer secondaries might be damaged or limiters blow before the fuse. Proper limiter-fuse coordination, facilitated by the use of fuses and limiters that are precisely matched, assures effective protection without unnecessary interruption.

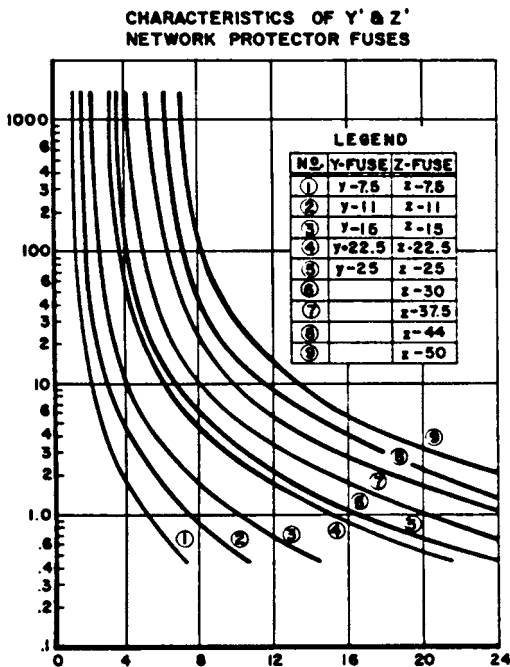

Figure 7: Amperes in Thousands

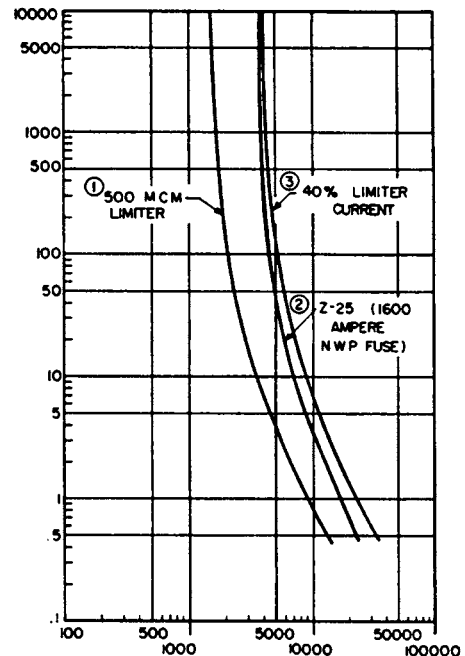
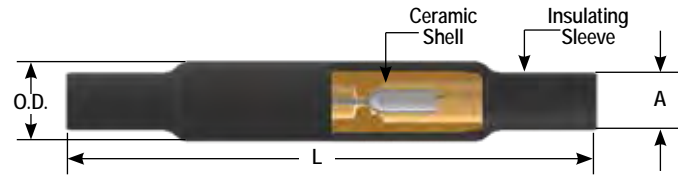

Figure 8: Current in Amperes

Limiter Assembly, Types YFS-CR, YFS-CP
With Ceramic Shell and Rubber Sleeve for Insulated Cables

The Limiter combines the functions of fuse and connector. The fusible element which is an integral part of the connector will clear faults that are great enough to cause damage to the cable insulation. However it will not clear on minor overloads of short duration. Fusing characteristics of the limiter are shown in technical section. For HYPRESS™ installation, see table below.



For conductor sizes not listed call customer service.

To specify a fast acting limiter in any configuration insert an "F" before the conductor number (e.g., YFSF34CR specifies a 1/2 thick limiter section).

*Paper Insulated Cable - Oil Tight Cable Sockets.

- ① Y35P3 Indentor Adaptor required for Y34PR Indentor
- ② Catalog number PUADP1 Adaptor is required to use "U" type dies in the 46 series tools
- ③ Catalog number PT6515 Adaptor is required to use "U" type dies in the 45 series tools

For Use On		Cable Size	Dimensions in Inches			Installation Tooling (# Crimps)							
Rubber Insulated Cable	Paper Insulated Cable*		Max. Cable Dia. over Insulation A	L	O.D.	Die Information		Hydraulic					
Catalog Number						Die Index	Type ①	Y34A	35, 750 Series	46 Series ②	45 Series ③	Y48B	60 Series
YFS28CR	YFS28CP	4/0 Str.	1	12-3/4	1-15/16	15	Purple Die Set	—	U28RT (2)	U28RT (2)	U28RT (2)	C28R (2)	L28RT (1)
							Nest Indentor	A28D (1) Y34PR	U28D1 (1) Y34PR	U28D1 (1) Y34PR	U28D1 (1) Y34PR	C28D (1) Y48PR	—
YFS29CR	YFS29CP	250 kcmil	1	12-3/4	1-15/16	16	Yellow Die Set	—	U29RT (2)	U29RT (2)	U29RT (2)	C29R (2)	L29RT (1)
							Nest Indentor	A29D (2) Y34PR	U29D1 (2) Y34PR	U29D1 (2) Y34PR	U29D1 (2) Y34PR	C29D (1) Y48PR	—
YFS30CR	YFS30CP	300 kcmil	1-1/8	13-1/2	2-3/16	17	White Die Set	—	U30RT (4)	U30RT (4)	U30RT (4)	C30R (1)	L30RT (1)
							Nest Indentor	A30D (2) Y34PR	U30D1 (2) Y34PR	U30D1 (2) Y34PR	U30D1 (2) Y34PR	C30D (2) Y48PR	—
YFS31CR	YFS31CP	350 kcmil	1-1/8	13-1/2	2-3/16	18	Red Die Set	—	U31RT (4)	U31RT (4)	U31RT (4)	C31R (1)	L31RT (1)
							Nest Indentor	A31D (2) Y34PR	U31D1 (2) Y34PR	U31D1 (2) Y34PR	U31D1 (2) Y34PR	C31D (1) Y48PR	—
YFS32CR	YFS32CP	400 kcmil	1-1/8	13-1/2	2-3/16	19	Blue Die Set	—	U32RT (4)	U32RT (4)	U32RT (4)	C32R (1)	L32RT (1)
							Nest Indentor	A32D (2) Y34PR	U32D1 (2) Y34PR	U32D1 (2) Y34PR	U32D1 (2) Y34PR	C32D (2) Y48PR	—
YFS34CR	YFS34CP	500 kcmil	1-11/32	15-7/8	2-3/8	20	Brown Die Set	—	U34RT (4)	U34RT (4) P34RT (4)	U34RT (4)	C34R (2)	L34RT (2)
							Nest Indentor	A34D (2) Y34PR	U34D1 (2) Y34PR	U34D1 (2) Y34PR	U34D1 (2) Y34PR	C34D (2) Y48PR	—

Long Limiter Assembly, Type YFS-CPL With Ceramic Shell and Rubber Sleeve for Paper-Lead Cables

The Long Limiter performs the same functions as the Limiter shown, Types YFS-CR and YFS-CP. It differs in that it has extra long cable sockets which are preferred by some for use on paper insulated cable. The end seams are sealed to make the sockets oil tight. Fusing characteristics of the Limiter are shown in technical section. For proper HYPRESS™ installation, see table below.

For conductor sizes not listed call customer service.

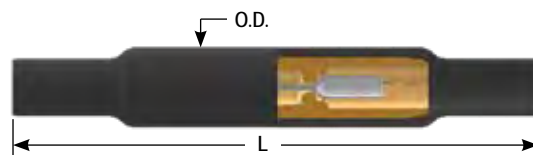

To specify a fast acting limiter in any configuration insert an "F" before the conductor number (e.g., YFSF34CR specifies a 1/2 thick limiter section).

- ① Y35P3 Indentor Adaptor required for Y34PR Indentor
- ② Catalog number PUADP1 Adaptor is required to use "U" type dies in the 46 series tools
- ③ Catalog number PT6515 Adaptor is required to use "U" type dies in the 45 series tools

Catalog Number	Cable Size	Dimensions in Inches			Installation Tooling (# Crimps)							
		Max. Cable Dia. over Insulation A	L	O.D.	Die Information		Hydraulic					
					Die Index	Type ①	Y34A	35, 750 Series	46 Series ②	45 Series ③	Y48B	60 Series
YFS28CPL	4/0 Str.	1	12-3/4	1-15/16	15	Purple Die Set	—	U28RT (2)	U28RT (2)	U28RT (2)	C28R (2)	L28RT (1)
						Nest Indentor	A28D (1) Y34PR	U28D1 (1) Y34PR	U28D1 (1) Y34PR	U28D1 (1) Y34PR	C28D (1) Y48PR	—
YFS29CPL	250 kcmil	1	12-3/4	1-15/16	16	Yellow Die Set	—	U29RT (2)	U29RT (2)	U29RT (2)	C29R (2)	L29RT (1)
						Nest Indentor	A29D (2) Y34PR	U29D1 (2) Y34PR	U29D1 (2) Y34PR	U29D1 (2) Y34PR	C29D (1) Y48PR	—
YFS30CPL	300 kcmil	1-1/8	13-1/2	2-3/16	17	White Die Set	—	U30RT (4)	U30RT (4)	U30RT (4)	C30R (1)	L30RT (1)
						Nest Indentor	A30D (2) Y34PR	U30D1 (2) Y34PR	U30D1 (2) Y34PR	U30D1 (2) Y34PR	C30D (2) Y48PR	—
YFS31CPL	350 kcmil	1-1/8	13-1/2	2-3/16	18	Red Die Set	—	U31RT (4)	U31RT (4)	U31RT (4)	C31R (1)	L31RT (1)
						Nest Indentor	A31D (2) Y34PR	U31D1 (2) Y34PR	U31D1 (2) Y34PR	U31D1 (2) Y34PR	C31D (1) Y48PR	—
YFS32CPL	400 kcmil	1-1/8	13-1/2	2-3/16	19	Blue Die Set	—	U32RT (4)	U32RT (4)	U32RT (4)	C32R (1)	L32RT (1)
						Nest Indentor	A32D (2) Y34PR	U32D1 (2) Y34PR	U32D1 (2) Y34PR	U32D1 (2) Y34PR	C32D (2) Y48PR	—
YFS34CPL	500 kcmil	1-11/32	15-7/8	2-3/8	20	Brown Die Set	—	U34RT (4)	U34RT (4) P34RT (4)	U34RT (4)	C34R (2)	L34RT (2)
						Nest Indentor	A34D (2) Y34PR	U34D1 (2) Y34PR	U34D1 (2) Y34PR	U34D1 (2) Y34PR	C34D (2) Y48PR	—

Limiters, Types YFSR, YFSP

For Use with Limiter Assembly

The Limiter serves the double function of a fuse and a coupler. The fusible element is an integral part of the coupler and is closely and carefully sized to insure excellent performance. Fusing characteristics of the Limiter are shown in technical section. For proper HYPRESS™ installation, see table below.

For conductor sizes not listed call customer service.

To specify a fast acting limiter in any configuration insert an "F" before the conductor number (e.g., YFSF34CR specifies a 1/2 thick limiter section).

*Paper Insulated Cable - Oil Tight Cable Sockets.

- ① Y35P3 Indentor Adaptor required for Y34PR Indentor
- ② Catalog number PUADP1 Adaptor is required to use "U" type dies in the 46 series tools
- ③ Catalog number PT6515 Adaptor is required to use "U" type dies in the 45 series tools

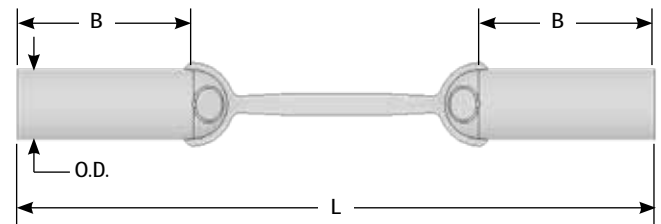

For use on Rubber Insulated Cable	For use on Paper Insulated Cable*	Cable Size	Dimensions in Inches			Installation Tooling (# Crimps)							
			B	L	O.D.	Die Information		Hydraulic					
						Die Index	Type ①	Y34A	35, 750 Series	46 Series ②	45 Series ③	Y48B	60 Series
YFSR28	YFSP28	4/0 Str.	1-3/4 in	6-3/8	11/16	15	Purple Die Set	—	U28RT (2)	U28RT (2)	U28RT (2)	C28R (2)	L28RT (1)
							Nest Indentor	A28D (1) Y34PR	U28D1 (1) Y34PR	U28D1 (1) Y34PR	U28D1 (1) Y34PR	C28D (1) Y48PR	—
YFSR29	YFSP29	250 kcmil	1-7/8 in	6-3/8	3/4	16	Yellow Die Set	—	U29RT (2)	U29RT (2)	U29RT (2)	C29R (2)	L29RT (1)
							Nest Indentor	A29D (2) Y34PR	U29D1 (2) Y34PR	U29D1 (2) Y34PR	U29D1 (2) Y34PR	C29D (1) Y48PR	—
YFSR30	YFSP30	300 kcmil	2 in	6-3/4	13/16	17	White Die Set	—	U30RT (4)	U30RT (4)	U30RT (4)	C30R (1)	L30RT (1)
							Nest Indentor	A30D (2) Y34PR	U30D1 (2) Y34PR	U30D1 (2) Y34PR	U30D1 (2) Y34PR	C30D (2) Y48PR	—
YFSR31	YFSP31	350 kcmil	2 in	6-3/4	7/8	18	Red Die Set	—	U31RT (4)	U31RT (4)	U31RT (4)	C31R (1)	L31RT (1)
							Nest Indentor	A31D (2) Y34PR	U31D1 (2) Y34PR	U31D1 (2) Y34PR	U31D1 (2) Y34PR	C31D (1) Y48PR	—
YFSR32	YFSP32	400 kcmil	2-1/8 in	7	31/32	19	Blue Die Set	—	U32RT (4)	U32RT (4)	U32RT (4)	C32R (1)	L32RT (1)
							Nest Indentor	A32D (2) Y34PR	U32D1 (2) Y34PR	U32D1 (2) Y34PR	U32D1 (2) Y34PR	C32D (2) Y48PR	—
YFSR34	YFSP34	500 kcmil	2-7/8 in	8-3/4	1-1/16	20	Brown Die Set	—	U34RT (4)	U34RT (4) P34RT (4)	U34RT (4)	C34R (2)	L34RT (2)
							Nest Indentor	A34D (2) Y34PR	U34D1 (2) Y34PR	U34D1 (2) Y34PR	U34D1 (2) Y34PR	C34D (2) Y48PR	—

Long Limiter, Type YFSP-L For Use with Long Limiter Assembly

The Long Limiter serves the same purpose as the Limiter shown above but has extra long oil tight cable sockets which may be preferred by some for use on paper insulated cables. Similarly designed to clear on overloads that will damage the insulation of the cable. Fusing characteristics of the Long Limiter are shown in technical section. For HYPRESS™ installation, see table below.

For conductor sizes not listed call customer service.

To specify a fast acting limiter in any configuration insert an "F" before the conductor number (e.g., YFSF34CR specifies a 1/2 thick limiter section).

- ① Y35P3 Indentor Adaptor required for Y34PR Indentor
- ② Catalog number PUADP1 Adaptor is required to use "U" type dies in the 46 series tools
- ③ Catalog number PT6515 Adaptor is required to use "U" type dies in the 45 series tools

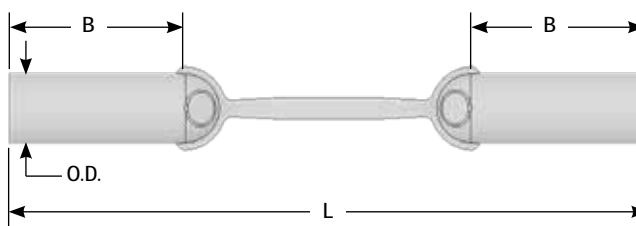

Catalog Number	Cable Size	Dimensions in Inches			Installation Tooling (# Crimps)							
		B	L	O.D.	Die Information		Hydraulic					
					Die Index	Type ①	Y34A	35, 750 Series	46 Series ②	45 Series ③	Y48B	60 Series
YFSP28L	4/0 Str.	2-15/16 in	8-3/4	11/16	15	Purple Die Set	—	U28RT (2)	U28RT (2)	U28RT (2)	C28R (2)	L28RT (1)
						Nest Indentor	A28D (1) Y34PR	U28D1 (1) Y34PR	U28D1 (1) Y34PR	U28D1 (1) Y34PR	C28D (1) Y48PR	—
YFSP29L	250 kcmil	3-1/16 in	8-3/4	3/4	16	Yellow Die Set	—	U29RT (2)	U29RT (2)	U29RT (2)	C29R (2)	L29RT (1)
						Nest Indentor	A29D (2) Y34PR	U29D1 (2) Y34PR	U29D1 (2) Y34PR	U29D1 (2) Y34PR	C29D (1) Y48PR	—
YFSP30L	300 kcmil	3-3/8 in	9-1/2	13/16	17	White Die Set	—	U30RT (4)	U30RT (4)	U30RT (4)	C30R (1)	L30RT (1)
						Nest Indentor	A30D (2) Y34PR	U30D1 (2) Y34PR	U30D1 (2) Y34PR	U30D1 (2) Y34PR	C30D (2) Y48PR	—
YFSP31L	350 kcmil	3-3/8 in	9-1/2	7/8	18	Red Die Set	—	U31RT (4)	U31RT (4)	U31RT (4)	C31R (1)	L31RT (1)
						Nest Indentor	A31D (2) Y34PR	U31D1 (2) Y34PR	U31D1 (2) Y34PR	U31D1 (2) Y34PR	C31D (1) Y48PR	—
YFSP32L	400 kcmil	3-3/8 in	9-1/2	31/32	19	Blue Die Set	—	U32RT (4)	U32RT (4)	U32RT (4)	C32R (1)	L32RT (1)
						Nest Indentor	A32D (2) Y34PR	U32D1 (2) Y34PR	U32D1 (2) Y34PR	U32D1 (2) Y34PR	C32D (2) Y48PR	—
YFSP34L	500 kcmil	4-3/16 in	11-3/8	1-1/16	20	Brown Die Set	—	U34RT (4)	U34RT (4) P34RT (4)	U34RT (4)	C34R (2)	L34RT (2)
						Nest Indentor	A34D (2) Y34PR	U34D1 (2) Y34PR	U34D1 (2) Y34PR	U34D1 (2) Y34PR	C34D (2) Y48PR	—

Limiter Lug Assembly, Types YFA-CR, YFA-CP
With Ceramic Shell and Rubber Sleeve

The Limiter Lug combines the functions of terminal and fuse. The fusible element is an integral part of the connector and is so designed that it will clear overloads which are great enough to cause damage to the cable insulation. Unlike an ordinary fuse, however, it will not clear on minor overloads of short duration. Fusing characteristics of the Limiter Lugs are shown in the technical section. Component parts shown in the table below may be purchased separately. For proper HYPRESS™ installation, see table below.

For conductor sizes not listed call customer service.

*Paper Insulated Cable - Oil Tight Cable Sockets.

- ① Y35P3 Indentor Adaptor required for Y34PR Indentor
- ② Catalog number PUADP1 Adaptor is required to use "U" type dies in the 46 series tools
- ③ Catalog number PT6515 Adaptor is required to use "U" type dies in the 45 series tools

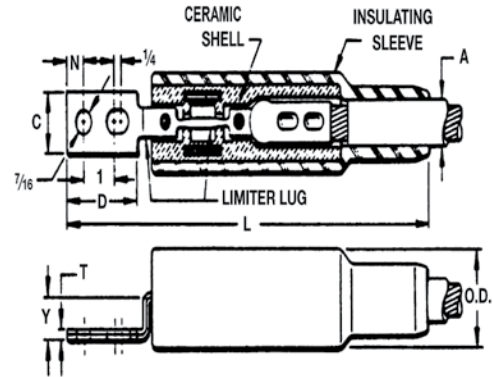

For Use On		Cable Size	Dimensions in Inches								Installation Tooling (# Crimps)							
Rubber Insulated Cable	Paper Insulated Cable*		(Max. Cable Dia. over Insul.) A	C	D	L	N	T	Y	O.D.	Die Information		Hydraulic					
Catalog Number											Die Index	Type ①	Y34A	35, 750 Series	46 Series ②	45 Series ③	Y48B	60 Series
YFA28CR2	YFA28CP2	4/0 Str.	1.00	1.00	2.19	11.56	0.44	0.14	0.84	2.00	15	Purple Die Set	—	U28RT (2)	U28RT (2)	U28RT (2)	C28R (2)	L28RT (1)
												Nest Indentor	A28D (1) Y34PR	U28D1 (1) Y34PR	U28D1 (1) Y34PR	U28D1 (1) Y34PR	C28D (1) Y48PR	—
YFA29CR2	YFA29CP2	250 kcmil	1.00	1.13	2.19	11.56	0.44	0.16	0.84	2.00	16	Yellow Die Set	—	U29RT (2)	U29RT (2)	U29RT (2)	C29R (2)	L29RT (1)
												Nest Indentor	A29D (2) Y34PR	U29D1 (2) Y34PR	U29D1 (2) Y34PR	U29D1 (2) Y34PR	C29D (1) Y48PR	—
YFA30CR2	YFA30CP2	300 kcmil	1.22	1.19	2.31	13.19	0.50	0.16	1.00	2.38	17	White Die Set	—	U30RT (4)	U30RT (4)	U30RT (4)	C30R (1)	L30RT (1)
												Nest Indentor	A30D (2) Y34PR	U30D1 (2) Y34PR	U30D1 (2) Y34PR	U30D1 (2) Y34PR	C30D (2) Y48PR	—
YFA31CR2	YFA31CP2	350 kcmil	1.22	1.31	2.31	13.19	0.50	0.19	1.00	2.38	18	Red Die Set	—	U31RT (4)	U31RT (4)	U31RT (4)	C31R (1)	L31RT (1)
												Nest Indentor	A31D (2) Y34PR	U31D1 (2) Y34PR	U31D1 (2) Y34PR	U31D1 (2) Y34PR	C31D (1) Y48PR	—
YFA32CR2	—	400 kcmil	1.22	1.44	2.31	13.19	0.50	0.19	1.00	2.38	19	Blue Die Set	—	U32RT (4)	U32RT (4)	U32RT (4)	C32R (1)	L32RT (1)
												Nest Indentor	A32D (2) Y34PR	U32D1 (2) Y34PR	U32D1 (2) Y34PR	U32D1 (2) Y34PR	C32D (2) Y48PR	—
YFA34CR2	YFA34CP2	500 kcmil	1.34	1.50	2.75	13.63	0.50	0.22	1.00	2.38	20	Brown Die Set	—	U34RT (4)	U34RT (4) P34RT (4)	U34RT (4)	C34R (2)	L34RT (2)
												Nest Indentor	A34D (2) Y34PR	U34D1 (2) Y34PR	U34D1 (2) Y34PR	U34D1 (2) Y34PR	C34D (2) Y48PR	—
YFA39CR2	YFA39CP2	750 kcmil	1.50	1.94	2.75	13.63	0.50	0.25	1.00	2.38	24	Black Die Set	—	U39RT (4)	U39RT (4) P39RT (4)	U39RT (4) S39RT (4)	C39R (2)	L39RT (2)
												Nest Indentor	—	—	P32D (2) P44PR	—	C39D (2) Y48PR	—

Long Limiter Lug Assembly, Type YFA-CPL With Ceramic Shell and Rubber Sleeve for Paper Lead Cables

A Limiter Lug similar to Type YFA-CR or YFACP. In this case, however, we supply an extra long cable socket which is sometimes preferred for use on paper insulated cable. The end seams are sealed to make sockets oil tight. Fusing characteristics of the Limiter Lugs are shown in the technical section. For proper HYPRESS™ installation, see table below.

For conductor sizes not listed call customer service.

- ① Y35P3 Indentor Adaptor required for Y34PR Indentor
- ② Catalog number PUADP1 Adaptor is required to use "U" type dies in the 46 series tools
- ③ Catalog number PT6515 Adaptor is required to use "U" type dies in the 45 series tools

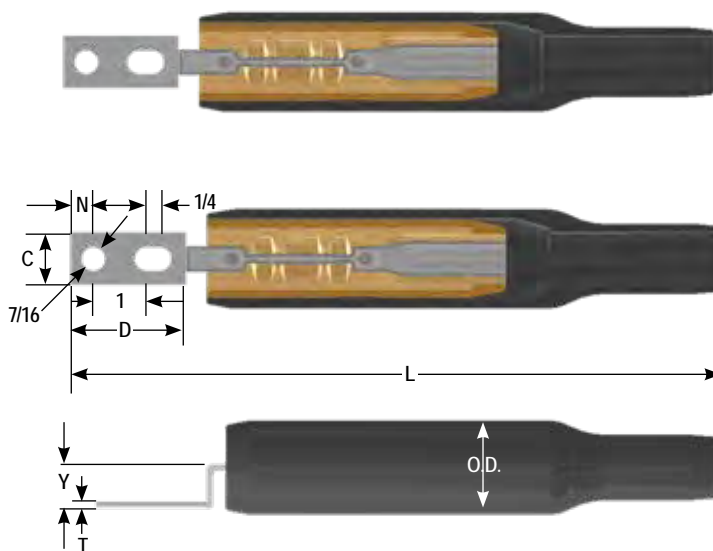

Catalog Number	Cable Size	(Max. Cable Dia. over Insul.) A	Dimensions in Inches							Installation Tooling (# Crimps)							
			C	D	L	N	T	Y	O.D.	Die Information		Hydraulic					
										Die Index	Type ①	Y34A	35, 750 Series	46 Series ②	45 Series ③	Y48B	60 Series
YFA28CPL2	4/0 Str.	1.00	1.00	2.19	11.56	0.44	0.14	0.84	2.00	15	Purple Die Set	—	U28RT (2)	U28RT (2)	U28RT (2)	C28R (2)	L28RT (1)
											Nest Indentor	A28D (1) Y34PR	U28D1 (1) Y34PR	U28D1 (1) Y34PR	U28D1 (1) Y34PR	C28D (1) Y48PR	—
YFA29CPL2	250 kcmil	1.00	1.09	2.19	11.56	0.44	0.16	0.84	1.75	16	Yellow Die Set	—	U29RT (2)	U29RT (2)	U29RT (2)	C29R (2)	L29RT (1)
											Nest Indentor	A29D (2) Y34PR	U29D1 (2) Y34PR	U29D1 (2) Y34PR	U29D1 (2) Y34PR	C29D (1) Y48PR	—
YFA30CPL2	300 kcmil	1.22	1.19	2.31	13.19	0.50	0.16	1.00	2.38	17	White Die Set	—	U30RT (4)	U30RT (4)	U30RT (4)	C30R (1)	L30RT (1)
											Nest Indentor	A30D (2) Y34PR	U30D1 (2) Y34PR	U30D1 (2) Y34PR	U30D1 (2) Y34PR	C30D (2) Y48PR	—
YFA31CPL2	350 kcmil	1.22	1.28	2.31	13.19	0.50	0.19	1.00	0.88	18	Red Die Set	—	U31RT (4)	U31RT (4)	U31RT (4)	C31R (1)	L31RT (1)
											Nest Indentor	A31D (2) Y34PR	U31D1 (2) Y34PR	U31D1 (2) Y34PR	U31D1 (2) Y34PR	C31D (1) Y48PR	—
YFA32CPL2	400 kcmil	1.22	1.44	2.31	13.19	0.50	0.19	1.00	2.38	19	Blue Die Set	—	U32RT (4)	U32RT (4)	U32RT (4)	C32R (1)	L32RT (1)
											Nest Indentor	A32D (2) Y34PR	U32D1 (2) Y34PR	U32D1 (2) Y34PR	U32D1 (2) Y34PR	C32D (2) Y48PR	—
YFA34CPL2	500 kcmil	1.34	1.50	2.75	13.63	0.50	0.22	1.00	1.06	20	Brown Die Set	—	U34RT (4)	U34RT (4) P34RT (4)	U34RT (4)	C34R (2)	L34RT (2)
											Nest Indentor	A34D (2) Y34PR	U34D1 (2) Y34PR	U34D1 (2) Y34PR	U34D1 (2) Y34PR	C34D (2) Y48PR	—
YFA39CPL2	750 kcmil	1.50	1.94	2.75	13.63	0.50	0.25	1.00	2.38	24	Black Die Set	—	U39RT (4)	U39RT (4) P39RT (4)	U39RT (4) S39RT (4)	C39R (2)	L39RT (2)
											Nest Indentor	—	—	P32D (2) P44PR	—	C39D (2) Y48PR	—

Limiter Lug, Types YFAR, YFAP
For Use with Limiter Lug Assembly

The Limiter Lug incorporates an accurately determined fusible section as an integral part with its terminal end. The fusible section is so selected that it will prevent the cable from roasting or damage from a short circuit, although it will not clear on minor overloads of short duration not harmful to cable insulation. For proper HYPRESS™ installation, see table below.

For conductor sizes not listed call customer service.

*Paper Insulated Cable - Oil Tight Cable Sockets.

- ① Y35P3 Indentor Adaptor required for Y34PR Indentor
- ② Catalog number PUADP1 Adaptor is required to use "U" type dies in the 46 series tools
- ③ Catalog number PT6515 Adaptor is required to use "U" type dies in the 45 series tools

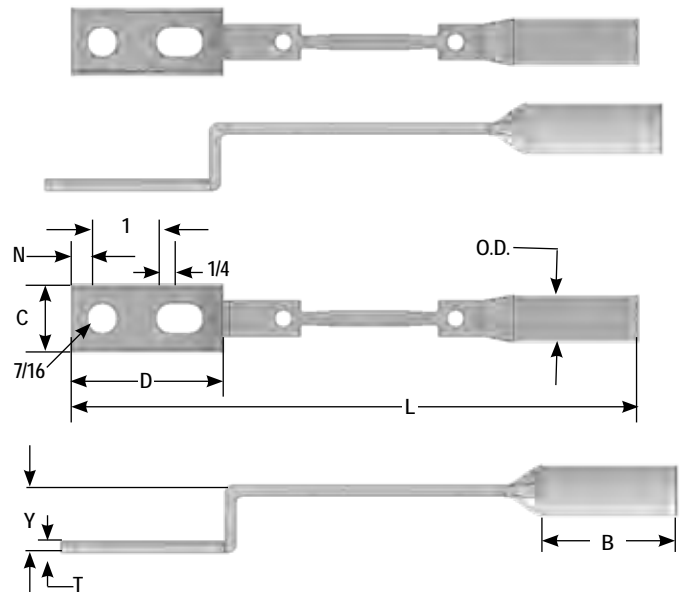

For Use On		Cable Size	Dimensions in Inches							Installation Tooling (# Crimps)								
Rubber Insulated Cable	Paper Insulated Cable*		B	C	D	L	N	T	Y	O.D.	Die Information		Hydraulic					
Catalog Number											Die Index	Type ①	Y34A	35, 750 Series	46 Series ②	45 Series ③	Y48B	60 Series
YFAR282	YFAP282	4/0 Str.	1.81	1.00	2.19	8.22	0.44	0.14	0.89	0.70	15	Purple Die Set	—	U28RT (2)	U28RT (2)	U28RT (2)	C28R (2)	L28RT (1)
												Nest Indentor	A28D (1) Y34PR	U28D1 (1) Y34PR	U28D1 (1) Y34PR	U28D1 (1) Y34PR	C28D (1) Y48PR	—
YFAR292	YFAP292	250 kcmil	1.81	1.09	2.19	8.22	0.44	0.16	0.91	0.76	16	Yellow Die Set	—	U29RT (2)	U29RT (2)	U29RT (2)	C29R (2)	L29RT (1)
												Nest Indentor	A29D (2) Y34PR	U29D1 (2) Y34PR	U29D1 (2) Y34PR	U29D1 (2) Y34PR	C29D (1) Y48PR	—
YFAR302	YFAP302	300 kcmil	1.94	1.19	2.31	8.88	0.50	0.16	1.07	0.83	17	White Die Set	—	U30RT (4)	U30RT (4)	U30RT (4)	C30R (1)	L30RT (1)
												Nest Indentor	A30D (2) Y34PR	U30D1 (2) Y34PR	U30D1 (2) Y34PR	U30D1 (2) Y34PR	C30D (2) Y48PR	—
YFAR312	YFAP312	350 kcmil	1.94	1.28	2.31	8.88	0.50	0.18	1.08	0.89	18	Red Die Set	—	U31RT (4)	U31RT (4)	U31RT (4)	C31R (1)	L31RT (1)
												Nest Indentor	A31D (2) Y34PR	U31D1 (2) Y34PR	U31D1 (2) Y34PR	U31D1 (2) Y34PR	C31D (1) Y48PR	—
YFAR322	YFAP322	400 kcmil	2.06	1.38	2.31	9.12	0.50	0.19	1.10	0.97	19	Blue Die Set	—	U32RT (4)	U32RT (4)	U32RT (4)	C32R (1)	L32RT (1)
												Nest Indentor	A32D (2) Y34PR	U32D1 (2) Y34PR	U32D1 (2) Y34PR	U32D1 (2) Y34PR	C32D (2) Y48PR	—
YFAR342	YFAP342	500 kcmil	2.44	1.54	2.75	10.00	0.50	0.23	1.11	0.97	20	Brown Die Set	—	U34RT (4)	U34RT (4) P34RT (4)	U34RT (4)	C34R (2)	L34RT (2)
												Nest Indentor	A34D (2) Y34PR	U34D1 (2) Y34PR	U34D1 (2) Y34PR	U34D1 (2) Y34PR	C34D (2) Y48PR	—
YFAR392	YFAP392	750 kcmil	2.44	1.91	2.75	10.00	0.50	0.26	1.14	1.34	24	Black Die Set	—	U39RT (4)	U39RT (4) P39RT (4)	U39RT (4) S39RT (4)	C39R (2)	L39RT (2)
												Nest Indentor	—	—	P32D (2) P44PR	—	C39D (2) Y48PR	—

Long Limiter Lug, Type YFAP-L For Use with Limited Lug Assembly

Similar to Limiter Lug Types YFAR and YFAP, except that this type provides a long oil tight cable socket, preferred by some users of paper-insulated cables. Fusing characteristics shown in technical section. For HYPRESS™ installation, see table below.

For conductor sizes not listed call customer service.

- ① Y35P3 Indentor Adaptor required for Y34PR Indentor
- ② Catalog number PUADP1 Adaptor is required to use "U" type dies in the 46 series tools
- ③ Catalog number PT6515 Adaptor is required to use "U" type dies in the 45 series tools

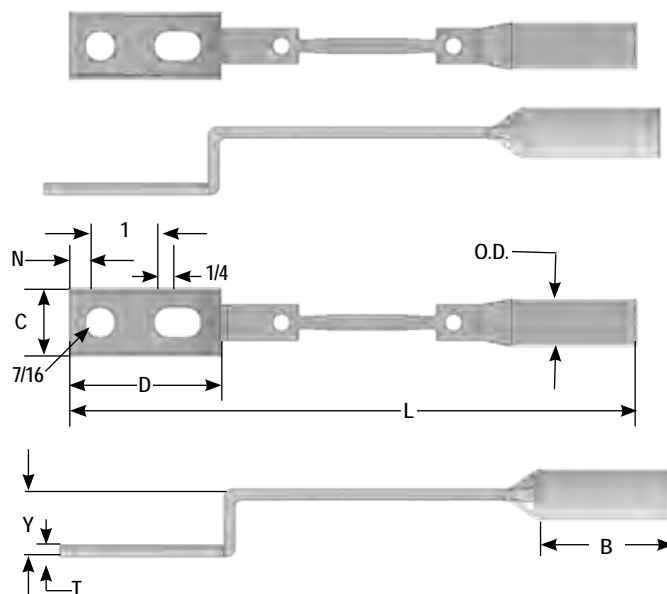

Catalog Number	Cable Size	Dimensions in Inches								Installation Tooling (# Crimps)							
		B	C	D	L	N	T	Y	O.D.	Die Information		Hydraulic					
										Die Index	Type ①	Y34A	35, 750 Series	46 Series ②	45 Series ③	Y48B	60 Series
YFAP28L2	4/0 Str.	3.50	1.00	2.19	10.44	0.44	0.14	0.89	0.69	15	Purple Die Set	—	U28RT (2)	U28RT (2)	U28RT (2)	C28R (2)	L28RT (1)
											Nest Indentor	A28D (1) Y34PR	U28D1 (1) Y34PR	U28D1 (1) Y34PR	U28D1 (1) Y34PR	C28D (1) Y48PR	—
YFAP29L2	250 kcmil	3.56	1.12	2.18	10.44	0.44	0.16	0.89	0.75	16	Yellow Die Set	—	U29RT (2)	U29RT (2)	U29RT (2)	C29R (2)	L29RT (1)
											Nest Indentor	A29D (2) Y34PR	U29D1 (2) Y34PR	U29D1 (2) Y34PR	U29D1 (2) Y34PR	C29D (1) Y48PR	—
YFAP30L2	300 kcmil	3.63	1.18	2.31	11.19	0.50	0.16	1.10	0.76	17	White Die Set	—	U30RT (4)	U30RT (4)	U30RT (4)	C30R (1)	L30RT (1)
											Nest Indentor	A30D (2) Y34PR	U30D1 (2) Y34PR	U30D1 (2) Y34PR	U30D1 (2) Y34PR	C30D (2) Y48PR	—
YFAP31L2	350 kcmil	3.63	1.38	2.31	11.38	0.50	0.18	1.08	0.82	18	Red Die Set	—	U31RT (4)	U31RT (4)	U31RT (4)	C31R (1)	L31RT (1)
											Nest Indentor	A31D (2) Y34PR	U31D1 (2) Y34PR	U31D1 (2) Y34PR	U31D1 (2) Y34PR	C31D (1) Y48PR	—
YFAP32L2	400 kcmil	3.75	1.38	2.31	11.50	0.50	0.19	1.10	0.89	19	Blue Die Set	—	U32RT (4)	U32RT (4)	U32RT (4)	C32R (1)	L32RT (1)
											Nest Indentor	A32D (2) Y34PR	U32D1 (2) Y34PR	U32D1 (2) Y34PR	U32D1 (2) Y34PR	C32D (2) Y48PR	—
YFAP34L2	500 kcmil	4.13	1.54	2.75	12.25	0.50	0.23	1.11	0.98	20	Brown Die Set	—	U34RT (4)	U34RT (4) P34RT (4)	U34RT (4)	C34R (2)	L34RT (2)
											Nest Indentor	A34D (2) Y34PR	U34D1 (2) Y34PR	U34D1 (2) Y34PR	U34D1 (2) Y34PR	C34D (2) Y48PR	—
YFAP39L2	750 kcmil	4.13	1.91	2.75	12.31	0.50	0.27	1.14	1.20	24	Black Die Set	—	U39RT (4)	U39RT (4) P39RT (4)	U39RT (4) S39RT (4)	C39R (2)	L39RT (2)
											Nest Indentor	—	—	P32D (2) P44PR	—	C39D (2) Y48PR	—

MOLIMITER™ Assembly, Types YFM-CR, YFM-CP
With Ceramic Shell and Rubber Sleeve for Insulated Cables

The MOLIMITER™ is used for fusing underground cables at junction points. The unit is designed for use with the BURNDY® MOLE™ and provides Limiter protection for cables, which terminate at the MOLE™. The cable end is installed in the MOLIMITER™ cable socket (see Installation Information in table below) and then the MOLE™ end is installed in the MOLE™ outlet Socket and Nut assembly. Any MOLIMITER which has burned clear may be quickly replaced. For time current characteristics see the technical section.

For conductor sizes not listed call customer service.

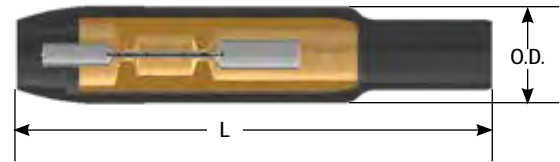

*Paper Insulated Cable - Oil Tight Cable Sockets.

- ① Y35P3 Indentor Adaptor required for Y34PR Indentor
- ② Catalog number PUADP1 Adaptor is required to use "U" type dies in the 46 series tools
- ③ Catalog number PT6515 Adaptor is required to use "U" type dies in the 45 series tools

For Use On		Cable Size	Dimensions in Inches			For Connection to MOLE™ Use		MOLE™ Outlet Size	Installation Tooling (# Crimps)							
Rubber Insulated Cable	Paper Insulated Cable*		(Max. Cable Dia. Over Insul.) A	L	O.D.	Socket and Nut Assembly	Z Cone		Die Information		Hydraulic					
Catalog Number									Die Index	Type ①	Y34A	35, 750 Series	46 Series ②	45 Series ③	Y48B	60 Series
YFM28CR	YFM28CP	4/0 Str.	1.34	11.69	2.38	Z28NR	Z2828	A	15	Purple Die Set	—	U28RT (2)	U28RT (2)	U28RT (2)	C28R (2)	L28RT (1)
										Nest Indentor	A28D (1) Y34PR	U28D1 (1) Y34PR	U28D1 (1) Y34PR	U28D1 (1) Y34PR	C28D (1) Y48PR	—
YFM29CR	YFM29CP	250 kcmil	1.34	11.69	2.38	Z29NR	Z2929	A	16	Yellow Die Set	—	U29RT (2)	U29RT (2)	U29RT (2)	C29R (2)	L29RT (1)
										Nest Indentor	A29D (2) Y34PR	U29D1 (2) Y34PR	U29D1 (2) Y34PR	U29D1 (2) Y34PR	C29D (1) Y48PR	—
YFM30CR	YFM30CP	300 kcmil	1.34	11.69	2.38	Z30NR	Z3030	A	17	White Die Set	—	U30RT (4)	U30RT (4)	U30RT (4)	C30R (1)	L30RT (1)
										Nest Indentor	A30D (2) Y34PR	U30D1 (2) Y34PR	U30D1 (2) Y34PR	U30D1 (2) Y34PR	C30D (2) Y48PR	—
YFM31CR	YFM31CP	350 kcmil	1.34	11.69	2.38	Z31NR	Z3131	A	18	Red Die Set	—	U31RT (4)	U31RT (4)	U31RT (4)	C31R (1)	L31RT (1)
										Nest Indentor	A31D (2) Y34PR	U31D1 (2) Y34PR	U31D1 (2) Y34PR	U31D1 (2) Y34PR	C31D (1) Y48PR	—
YFM32CR	YFM32CP	400 kcmil	1.34	11.69	2.38	Z32NR	Z3232	A	19	Blue Die Set	—	U32RT (4)	U32RT (4)	U32RT (4)	C32R (1)	L32RT (1)
										Nest Indentor	A32D (2) Y34PR	U32D1 (2) Y34PR	U32D1 (2) Y34PR	U32D1 (2) Y34PR	C32D (2) Y48PR	—
YFM34CR	YFM34CP	500 kcmil	1.34	11.69	2.38	Z34NR	Z3434	A	20	Brown Die Set	—	U34RT (4)	U34RT (4) P34RT (4)	U34RT (4)	C34R (2)	L34RT (2)
										Nest Indentor	A34D (2) Y34PR	U34D1 (2) Y34PR	U34D1 (2) Y34PR	U34D1 (2) Y34PR	C34D (2) Y48PR	—

Long MOLIMITER™ Assembly, Type YFM-CPL With Ceramic Shell and Rubber Sleeve for Paper Lead Cables

The Long MOLIMITER™ differs from the standard MOLIMITER™ only in its extra long cable socket. This socket, with the end seam sealed oil tight, is preferred by some for use on paper insulated cables. Time-current characteristics are shown in the technical section. For proper HYPRESS™ installation, see table below.

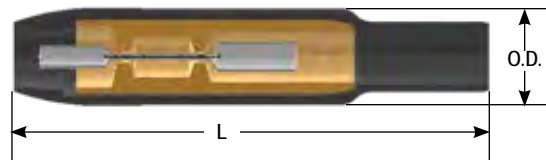

For conductor sizes not listed call customer service.

- ① Y35P3 Indentor Adaptor required for Y34PR Indentor
- ② Catalog number PUADP1 Adaptor is required to use "U" type dies in the 46 series tools
- ③ Catalog number PT6515 Adaptor is required to use "U" type dies in the 45 series tools

Catalog Number	Cable Size	Dimensions in Inches			For Connection to MOLE™ Use		MOLE™ Outlet Size	Installation Tooling (# Crimps)							
		(Max. Cable Dia. Over Insul.) A	L	O.D.	Socket & Nut Assembly	Z Cone		Die Information		Hydraulic					
								Die Index	Type ①	Y34A	35, 750 Series	46 Series ②	45 Series ③	Y48B	60 Series
YFM28CPL	4/0 Str.	1.34	11.69	2.38	Z28NR	Z2828	A	15	Purple Die Set	—	U28RT (2)	U28RT (2)	U28RT (2)	C28R (2)	L28RT (1)
									Nest Indentor	A28D (1) Y34PR	U28D1 (1) Y34PR	U28D1 (1) Y34PR	U28D1 (1) Y34PR	C28D (1) Y48PR	—
YFM29CPL	250 kcmil	1.34	11.69	2.38	Z29NR	Z2929	A	16	Yellow Die Set	—	U29RT (2)	U29RT (2)	U29RT (2)	C29R (2)	L29RT (1)
									Nest Indentor	A29D (2) Y34PR	U29D1 (2) Y34PR	U29D1 (2) Y34PR	U29D1 (2) Y34PR	C29D (1) Y48PR	—
YFM30CPL	300 kcmil	1.34	11.69	2.38	Z30NR	Z3030	A	17	White Die Set	—	U30RT (4)	U30RT (4)	U30RT (4)	C30R (1)	L30RT (1)
									Nest Indentor	A30D (2) Y34PR	U30D1 (2) Y34PR	U30D1 (2) Y34PR	U30D1 (2) Y34PR	C30D (2) Y48PR	—
YFM31CPL	350 kcmil	1.34	11.69	2.38	Z32NR	Z3132	A	18	Red Die Set	—	U31RT (4)	U31RT (4)	U31RT (4)	C31R (1)	L31RT (1)
									Nest Indentor	A31D (2) Y34PR	U31D1 (2) Y34PR	U31D1 (2) Y34PR	U31D1 (2) Y34PR	C31D (1) Y48PR	—
YFM32CPL	400 kcmil	1.34	11.69	2.38	Z32NR	Z3232	A	19	Blue Die Set	—	U32RT (4)	U32RT (4)	U32RT (4)	C32R (1)	L32RT (1)
									Nest Indentor	A32D (2) Y34PR	U32D1 (2) Y34PR	U32D1 (2) Y34PR	U32D1 (2) Y34PR	C32D (2) Y48PR	—
YFM34CPL	500 kcmil	1.34	11.69	2.38	Z34NR	Z3434	A	20	Brown Die Set	—	U34RT (4)	U34RT (4) P34RT (4)	U34RT (4)	C34R (2)	L34RT (2)
									Nest Indentor	A34D (2) Y34PR	U34D1 (2) Y34PR	U34D1 (2) Y34PR	U34D1 (2) Y34PR	C34D (2) Y48PR	—

MOLIMITER™ Limiter, Types YFMR, YFMP
For Use with Long MOLIMITER™ Assembly

The MOLIMITER™ combines an accurately determined fusible section with both a MOLE™ Socket end and a cable socket. Designed to clear on overloads that would injure the cable insulation, the MOLIMITER™ may be easily and quickly replaced. For time current characteristics of MOLIMITER see the technical section. For proper HYPRESS™ installation, see table below.

For conductor sizes not listed call customer service.

*Paper Insulated Cable - Oil Tight Cable Sockets.

- ① Y35P3 Indentor Adaptor required for Y34PR Indentor
- ② Catalog number PUADP1 Adaptor is required to use "U" type dies in the 46 series tools
- ③ Catalog number PT6515 Adaptor is required to use "U" type dies in the 45 series tools

NOTE: To specify a fast acting limiter in any configuration insert an "F" before the conductor number e.g. YFSF34CR specifies a 1/2 thick limiter section.

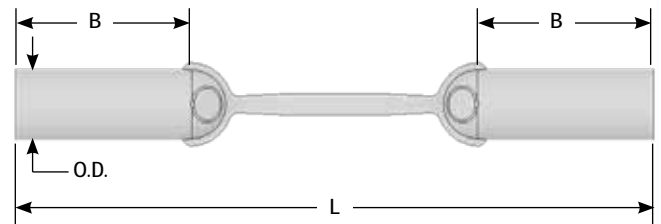

For Use On		Cable Size A	Dimensions in Inches			For Connection to MOLE™ Use		MOLE™ Outlet Size	Installation Tooling (# Crimps)							
Rubber Insulated Cable	Paper Insulated Cable*		B	L	O.D.	Socket and Nut Assembly	Z Cone		Die Information		Hydraulic					
Catalog Number									Die Index	Type ①	Y34A	35, 750 Series	46 Series ②	45 Series ③	Y48B	60 Series
YFMR28	YFMP28	4/0 Str.	1.86	6.28	0.83	Z28NR	Z2828	A	15	Purple Die Set	—	U28RT (2)	U28RT (2)	U28RT (2)	C28R (2)	L28RT (1)
										Nest Indentor	A28D (1) Y34PR	U28D1 (1) Y34PR	U28D1 (1) Y34PR	U28D1 (1) Y34PR	C28D (1) Y48PR	—
YFMR29	YFMP29	250 kcmil	1.88	6.19	0.84	Z29NR	Z2929	A	16	Yellow Die Set	—	U29RT (2)	U29RT (2)	U29RT (2)	C29R (2)	L29RT (1)
										Nest Indentor	A29D (2) Y34PR	U29D1 (2) Y34PR	U29D1 (2) Y34PR	U29D1 (2) Y34PR	C29D (1) Y48PR	—
YFMR30	YFMP30	300 kcmil	2.00	6.81	0.96	Z30NR	Z3030	A	17	White Die Set	—	U30RT (4)	U30RT (4)	U30RT (4)	C30R (1)	L30RT (1)
										Nest Indentor	A30D (2) Y34PR	U30D1 (2) Y34PR	U30D1 (2) Y34PR	U30D1 (2) Y34PR	C30D (2) Y48PR	—
YFMR31	YFMP31	350 kcmil	2.00	6.94	0.91	Z32NR	Z3132	A	18	Red Die Set	—	U31RT (4)	U31RT (4)	U31RT (4)	C31R (1)	L31RT (1)
										Nest Indentor	A31D (2) Y34PR	U31D1 (2) Y34PR	U31D1 (2) Y34PR	U31D1 (2) Y34PR	C31D (1) Y48PR	—
YFMR32	YFMP32	400 kcmil	2.14	7.27	0.97	Z32NR	Z3232	A	19	Blue Die Set	—	U32RT (4)	U32RT (4)	U32RT (4)	C32R (1)	L32RT (1)
										Nest Indentor	A32D (2) Y34PR	U32D1 (2) Y34PR	U32D1 (2) Y34PR	U32D1 (2) Y34PR	C32D (2) Y48PR	—
YFMR34	YFMP34	500 kcmil	2.75	8.26	1.13	Z34NR	Z3434	A	20	Brown Die Set	—	U34RT (4)	U34RT (4) P34RT (4)	U34RT (4)	C34R (2)	L34RT (2)
										Nest Indentor	A34D (2) Y34PR	U34D1 (2) Y34PR	U34D1 (2) Y34PR	U34D1 (2) Y34PR	C34D (2) Y48PR	—

Long MOLIMITER™ Limiter, Type YFMP-L For Use with Long MOLIMITER™ Assembly

Similar to Type YFMR and YFMP except for a long oil tight cable socket preferred by some users of paper-insulated cable. Fusing characteristics shown in the technical sections. For proper HYPRESS™ installation, see table below

For conductor sizes not listed call customer service.

To specify a fast acting limiter in any configuration insert an "F" before the conductor number (e.g., YFSF34CR specifies a 1/2 thick limiter section).

- ① Y35P3 Indentor Adaptor required for Y34PR Indentor
- ② Catalog number PUADP1 Adaptor is required to use "U" type dies in the 46 series tools
- ③ Catalog number PT6515 Adaptor is required to use "U" type dies in the 45 series tools

NOTE: To specify a fast acting limiter in any configuration insert an "F" before the conductor number e.g. YFSF34CR specifies a 1/2 thick limiter section.

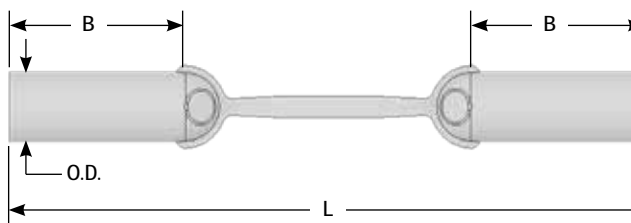

Catalog No.	Cable Size	Dimensions in Inches			For Connection to MOLE™ Use		MOLE™ Outlet Size	Installation Tooling (# Crimps)							
		B	L	O.D.	Socket & Nut Assembly	Z Cone		Die Information		Hydraulic					
								Die Index	Type ①	Y34A	35, 750 Series	46 Series ②	45 Series ③	Y48B	60 Series
YFMP28L	4/0 Str.	3.06	7.25	0.69	Z28NR	Z2828	A	15	Purple Die Set	—	U28RT (2)	U28RT (2)	U28RT (2)	C28R (2)	L28RT (1)
									Nest Indentor	A28D (1) Y34PR	U28D1 (1) Y34PR	U28D1 (1) Y34PR	U28D1 (1) Y34PR	C28D (1) Y48PR	—
YFMP29L	250 kcmil	3.56	7.88	0.75	Z29NR	Z2929	A	16	Yellow Die Set	—	U29RT (2)	U29RT (2)	U29RT (2)	C29R (2)	L29RT (1)
									Nest Indentor	A29D (2) Y34PR	U29D1 (2) Y34PR	U29D1 (2) Y34PR	U29D1 (2) Y34PR	C29D (1) Y48PR	—
YFMP30L	300 kcmil	3.67	8.48	0.81	Z30NR	Z3030	A	17	White Die Set	—	U30RT (4)	U30RT (4)	U30RT (4)	C30R (1)	L30RT (1)
									Nest Indentor	A30D (2) Y34PR	U30D1 (2) Y34PR	U30D1 (2) Y34PR	U30D1 (2) Y34PR	C30D (2) Y48PR	—
YFMP31L	350 kcmil	3.69	8.66	0.88	Z32NR	Z3132	A	18	Red Die Set	—	U31RT (4)	U31RT (4)	U31RT (4)	C31R (1)	L31RT (1)
									Nest Indentor	A31D (2) Y34PR	U31D1 (2) Y34PR	U31D1 (2) Y34PR	U31D1 (2) Y34PR	C31D (1) Y48PR	—
YFMP32L	400 kcmil	3.81	8.66	0.95	Z32NR	Z3232	A	19	Blue Die Set	—	U32RT (4)	U32RT (4)	U32RT (4)	C32R (1)	L32RT (1)
									Nest Indentor	A32D (2) Y34PR	U32D1 (2) Y34PR	U32D1 (2) Y34PR	U32D1 (2) Y34PR	C32D (2) Y48PR	—
YFMP34L	500 kcmil	4.13	9.44	1.06	Z34NR	Z3434	A	20	Brown Die Set	—	U34RT (4)	U34RT (4) P34RT (4)	U34RT (4)	C34R (2)	L34RT (2)
									Nest Indentor	A34D (2) Y34PR	U34D1 (2) Y34PR	U34D1 (2) Y34PR	U34D1 (2) Y34PR	C34D (2) Y48PR	—

Limiters Tap Assembly, Type VYFT
 For Insulated Cables

The Limiter Tap is suitable for making Limiter connections to a cable ring bus in a manhole or transformer vault. It can be installed on oil impregnated, paper insulated, or rubber insulated cable. Fusing characteristics of the Limiter are the same as Type YFA shown in the technical section. The rubber sleeve and insulating hood reduce taping to a minimum. Catalog Numbers shown include hoods. If no hood is required, eliminate one "C" from the Catalog Number. Replaceable Link Limiter Taps can be ordered. For proper HYPRESS™ installation, see table below.

Paper-Lead Cables: If a long cable socket is preferred for use on paper insulated cable add "L" to the catalog number (e.g., VYFT3428CCP becomes VYFT3428CCPL).

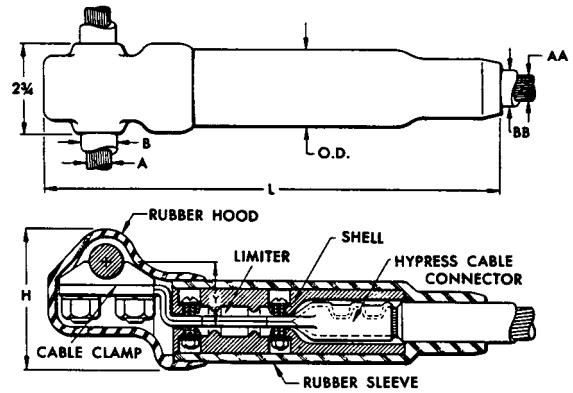

For Use on Rubber Insulated Cable Catalog No.	For Use on Paper Insulated Cable-Oil Tight Cable Socket Catalog No.	A Run	AA Tap	Dimensions in Inches						Installation Information	
				B Max. Cable Dia. Over Insul.	BB Max. Cable Dia. Over Insul.	H	L	Y	O.D.	HYPRESS™ & Indentor Die	No. of Indents
VYFT3428CCR	VYFT3428CCP	500 kcmil	4/0 Str.	1.09	1.00	4.00	12.19	1.75	1.94	Y34BH with Y34PR Nest Die	
VYFT3434CCR	VYFT3434CCP	500 kcmil	500 kcmil	1.09	1.34	4.00	14.19	1.75	2.38	No Nest Die Req'd.	2
VYFT3934CCR	VYFT3934CCP	750 kcmil	500 kcmil	1.31	1.34	4.00	14.19	1.75	2.38		2
VYFT4434CCR	VYFT4434CCP	1000 kcmil	500 kcmil	1.08	1.34	4.13	14.19	2.09	2.38		2

To specify a fast acting limiter in any configuration insert an "F" before the conductor number (e.g., YFSF34CR specifies a 1/2 thick limiter section).

Limiters Tee Tap, Type NYFT
 For Rubber or Paper Insulated Cables

The NYFT Limiter is similar to Type VYFT except the run conductor is clamped with a four bolt cap and the Limiter Tap is removable by means of a socket and nut assembly. The Limiter current characteristics are the same as Type YFA shown in the technical section.

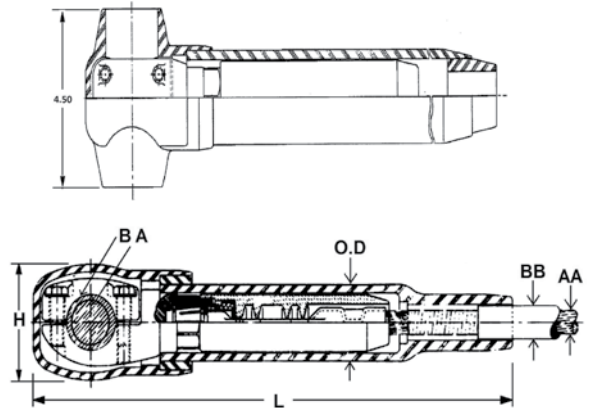

For Use on Rubber Insulated Cable Catalog No.	For Use on Paper Insulated Cable-Oil Tight Cable Socket Catalog No.	A Run	AA Tap	Dimensions in Inches					Installation Information	
				B Max. Cable Dia. Over Insul.	BB Max. Cable Dia. Over Insul.	H	L	O.D.	HYPRESS™ & Indentor Die	No. of Indents
NYFT3434CCR	NYFT3434CCP	500 kcmil	500 kcmil	1.89	1.25	2.91	16.78	2.41	Y34BH with Y34PR Nest Die	

Replaceable Link Limiter, Type LYS With Ceramic Shell and Rubber Sleeve for Insulated Cables

The Replaceable Link Limiter incorporates the functions of both fuse and coupler. For use with rubber and paper-insulated cable, it is designed to facilitate rapid and inexpensive replacement of Limiter Links upon clearing. It also permits, if desired, the use of a Link rated for a lower ampere capacity than supplied with our standard Limiter. For proper HYPRESS™ installation, see table below.

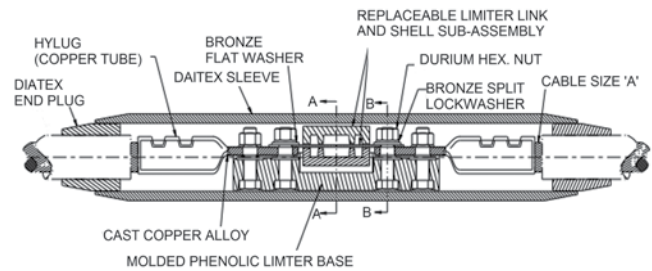

Catalog Number	Cable Size	** (Max. Cable Dia. Over Insul. Inches) A	Number of Indents in Cable Socket	* Link Supplied		Installation Information	
				Ampere Capacity	Catalog Number	No. of Indents	Installation Die Index Number
LYS4CC	#4 Str.	0.50	1	75A	LF1010	1	95
LYS2CC	#2 Str.	0.75		100A	LF1014		97
LYS1CC	#1 Str.			LF1014	98		
LYS25C	1/0 Str.			LF1025	99		
LYS26C	2/0 Str.			LF1025	100		
LYS27C	3/0 Str.	1.00		200A	LF2019		101
LYS28C	4/0 Str.			LF2027	15		
LYS29C	250 kcmil			LF2027	16		
LYS30C	300 kcmil		1.25	300A	LF2038	17	
LYS31C	350 kcmil	LF2038		18			
LYS32C	400 kcmil	2		400A	LF2065	19	
LYS34C	500 kcmil			20			

* Fuse link supplied is selected on the basis of a minimum blowing current of approximately twice the NEC rubber insulated cable rating. Refer to Time Current curves shown and specify if another size is desired.

** The standard end bushing supplied is for maximum cable insulation diameters as shown. Compact cable will require a bushing with a smaller inside diameter to accommodate the smaller insulation diameter of the cable. If other than standard bushing is required, contact customer service.

To specify a fast acting limiter in any configuration insert a "F" before the conductor number (e.g., YFSF34CR specifies a 1/2 thick limiter section).

Replaceable Link MOLIMITER™, Type LYM
With Ceramic Shell and Rubber Sleeve for Insulated Cables

The Replaceable Link MOLIMITER™ is used to fuse underground cables at junction points with the BURNDY® MOLE™. The "Replaceable Link" feature permits the selection of one of several links. In addition, the replacement of links that have burned clear is both rapid and inexpensive. For use with both rubber and paper insulated cables. The MOLE™ end of the MOLIMITER™ is installed in the MOLE™ Socket and Nut Assembly, while the cable socket end is HYPRESS™ installed, see table below for proper installation.

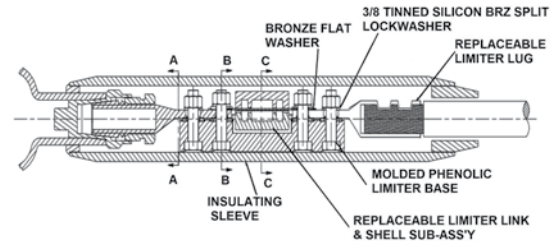

Catalog Number	Cable Size	** (Max. Cable Dia. Over Insul. Inches) A	Number of Indents in Cable Socket	* Link Supplied		For Connection to MOLE™ Use		Installation Information	
				Ampere Capacity	Catalog Number	Socket & Nut Assembly	Z Cone	No. of Indents	Installation Die Index Number
						Catalog Number	Catalog Number		
LYM2CC	2 Str.	0.75	1	100A	LF1014	Z28NR	Z2828	1	97
LYM1CC	1 Str.				LF1014				98
LYM25C	1/0 Str.			LF1025	99				
LYM26C	2/0 Str.			LF1025	100				
LYM27C	3/0 Str.	1.00	1	200A	LF2019	Z29NR	Z2929	1	101
LYM28C	4/0 Str.			250A	LF2027				15
LYM29C	250 kcmil			LF2027	16				
LYM30C	300 kcmil			300A	LF2038				Z30NR
LYM31C	350 kcmil	1.25	2	300A	LF2038	Z32NR	Z3132	2	18
LYM32C	400 kcmil			400A	LF2065	Z32NR	Z3232		19
LYM34C	500 kcmil			LF2065	Z34NR	Z3434	20		

* Fuse link supplied is selected on the basis of a minimum blowing current of approximately twice the NEC rubber insulated cable rating. Refer to Time Current curves shown and specify if another size is desired.

** The standard end bushing supplied is for maximum cable insulation diameters as shown. Compact cable will require a bushing with a smaller inside diameter to accommodate the smaller insulation diameter of the cable. If other than standard bushing is required, contact customer service.

Limiter Link, Type LF

For Use with All Replaceable Limiters

Made of pure copper, the Limiter Link is controlled dimensionally to close tolerances to maintain accurate fusing characteristics. Refer to Time-Current Characteristic curve shown below and specify rating desired. The Limiter Link is supplied enclosed in a shell with heatproof chamber to confine and break the arc created by fusing.

*Catalog Number	Ampere Capacity
LF1006	50A
LF1010	75A
LF1014	100A
LF1025	150A
LF2019	200A
LF2027	250A
LF2038	300A
LF2065	400A
LF2108	500A

* For use with LYS and LYM.

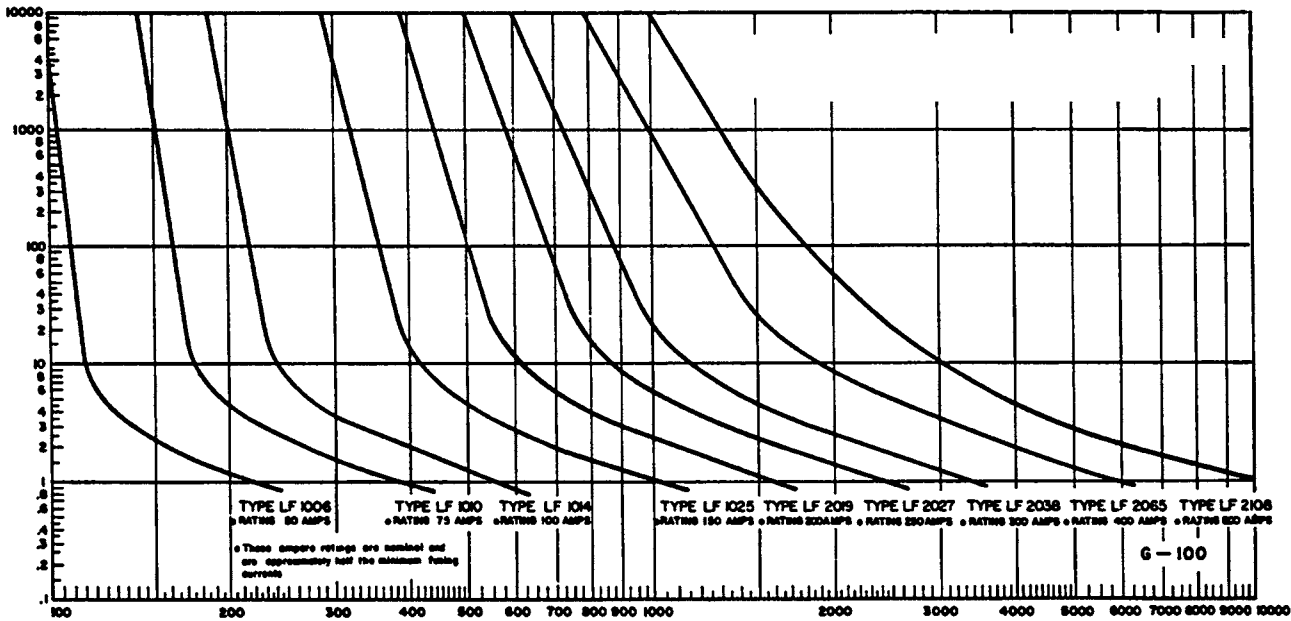
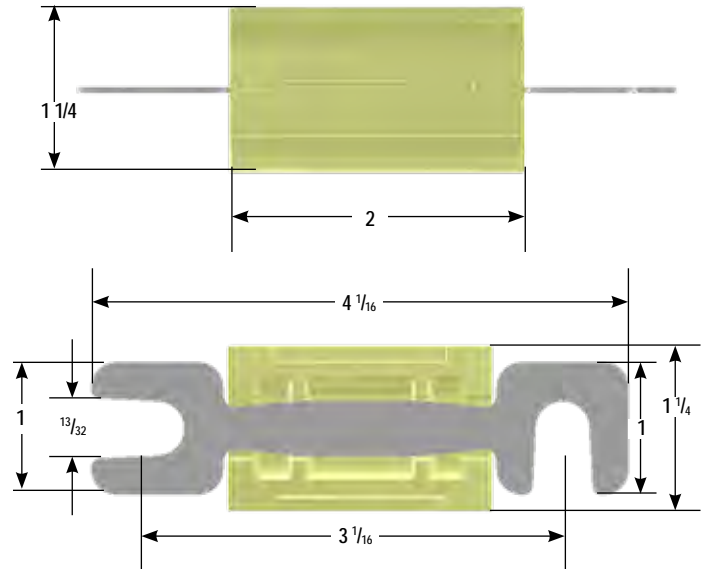

Current in Amperes

Time-Current Fusing Characteristics of Type LF Limiter Links

The nominal current ratings of these Limiter Links are approximately one-half the minimum currents required to clear the fuses. The general slope and shape of the curves are similar to those of the time-current curves of the Limiters. The Type LF Limiter Links are made of pure copper with dimensions carefully controlled in order to maintain accurate fusing characteristics.

Limiter Base, Type LYBASEH

For Use with All Replaceable Limiters

A heat resisting, high impact, molded phenolic base for mounting HYDENT™ Cable lugs or MOLIMITER™-lugs. The bases are supplied with bolts fitted in place with retaining rings, enabling the lugs to be easily assembled to BURNDY® Replaceable Limiter Links. They may be purchased separately for use with all Replaceable Limiters.

Catalog Number	For Use with
LYBASEH	LYM
	LYS

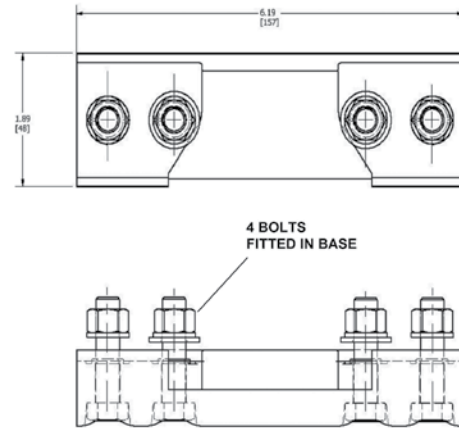

Limiter Sleeve, Type LYS34P2

For Use with All Replaceable Limiters

A molded sleeve for insulating the Replaceable Limiter and MOLIMITER™ assemblies. Similar to other component parts, the insulating sleeves may be purchased separately. These sleeves are used in conjunction with the LYS-P6 bushings.

Catalog Number	For Use with
LYS34P2	LYS
	LYM

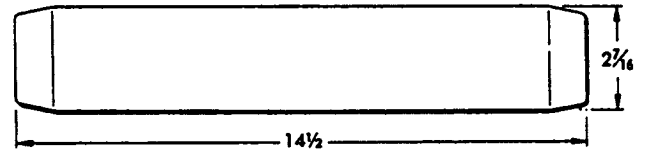

HYLUG™ Terminal, Type LYS-P5

For Use with All Replaceable Limiters

Fabricated of high copper alloy, this terminal has a sealed cable socket for use with paper insulated, oil-impregnated cables as well as rubber-insulated cables. Tin plated to retard corrosion and prevent discoloration. The HYLUG™ is for use with LYS and LYM.

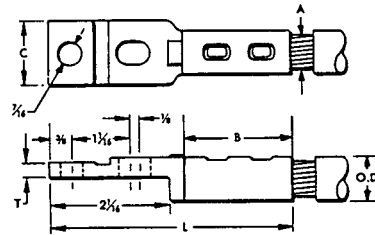

Catalog Number	Cable Size A	Dimensions in Inches					Installation Information	
		B	C	L	T	O.D.	No. of Indents	Installation Tool Index Number
LYS6CP5	#6 Str.	1-1/4	3/4	3-9/16	3/16	5/16	1	94
LYS4CP5	#4 Str.			3-5/8		11/32		95
LYS2CP5	#2 Str.	1-9/32		3-3/4		13/32		97
LYS1CP5	#1 Str.	1-3/8		3-29/32		15/32		98
LYS25P5	1/0 Str.			3-15/16		17/32		99
LYS26P5	2/0 Str.	1-1/2	13/16	4-1/16	9/16	2	100	
LYS27P5	3/0 Str.		29/32		5/8		101	
LYS28P5	4/0 Str.	1-5/8	1-1/8	4-3/16	11/16	2	15	
LYS29P5	250 kcmil				3/4		16	
LYS30P5	300 kcmil	2	1-3/8	4-9/16	13/16	2	17	
LYS31P5	350 kcmil		1-9/16		4-11/16		7/8	18
LYS32P5	400 kcmil	2-1/8		4-11/16	31/32	19		
LYS34P5	500 kcmil	2-1/4		4-13/16	1-1/16	20		

Bushing, Type LYM34P3

For Use with All Replaceable Limiters

Type LYM34P3 is for assembly of Replaceable MOLIMITERS™ to the MOLE™ outlet. It fills the space between Limiter sleeve and the MOLE™ outlet to allow easy taping.

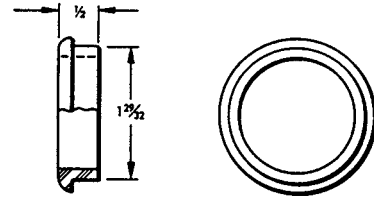

Catalog Number	For Use with	MOLE™ Outlet Size
LYM34P3	LYM	A
	LZM	

Bushing, Type LYS-P6

For Use with All Replaceable Limiters

The LYS-P6 bushing is designed to fit closely over the cable insulation when used with the LYS34P2 Limiter sleeve. It fills the space between the Limiter sleeve and cable. The tapered bushing facilitates taping at installation.

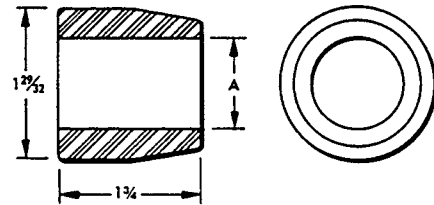

Catalog Number	(Max. Cable Dia. Over Insul.) A	For Use with
LYS32P6	1/2	LYS LYM
LYS48P6	3/4	
LYS64P6	1	
LYS80P6	1-1/4	

T-Connector, Type NYT Cable Run / Cable Tap

A "T" connector designed to provide a clamp type element on the run and a permanent HYPRESS™ connection on the tap. Recommended for use on ring buses or for applications where occasional disconnects from the run conductor are desired without disturbing the tap connection. Tin plated. For proper installation of tap cable, see table below.

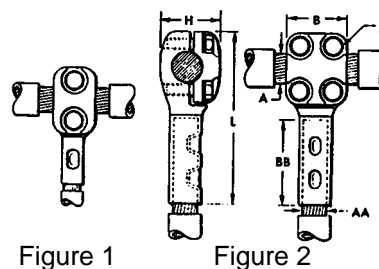

Figure 1

Figure 2

Catalog Number	Conductor Size		Fig. No.	Dimensions in Inches					Installation Information		
									HYPRESS™ & Indentor Die		No. of Indents
									Y34B with Y34PR		
Run A	Tap AA	B	BB	H	J	L	Nest Die				
NYT282C	4/0 AWG	2/0 AWG	1	1-3/8	1-1/4	1-3/8	3/8	3-3/16	B2CD	1	
NYT2825		1/0	1	1-3/8	1-3/8	1-3/8	3/8	4	B25D	1	
NYT2826		2/0 AWG	1	1-3/8	1-1/2	1-3/8	3/8	4-1/8	B26D	1	
NYT2828		4/0 AWG	2	2	1-5/8	1-3/8	3/8	4-5/16	B28D	1	
NYT292C	250 kcmil	2/0 AWG	1	1-3/8	1-1/4	1-7/16	3/8	3-3/16	B2CD	1	
NYT2925		1/0	1	1-3/8	1-3/8	1-7/16	3/8	4-1/16	B25D	1	
NYT2926		2/0 AWG	1	1-3/8	1-1/2	1-7/16	3/8	4-3/16	B26D	1	
NYT2928		4/0 AWG	2	2	1-5/8	1-7/16	3/8	4-3/8	B28D	1	
NYT2929		250 kcmil	2	2	1-5/8	1-7/16	3/8	4-7/16	B29D	1	
NYT3125	350 kcmil	1/0	1	1-3/8	1-3/8	1-1/2	3/8	4-1/8	B25D	1	
NYT3126		2/0 AWG	1	1-3/8	1-1/2	1-1/2	3/8	4-5/16	B26D	1	
NYT3128		4/0 AWG	2	2	1-5/8	1-1/2	3/8	4-1/2	B28D	1	
NYT3129		250 kcmil	2	2	1-5/8	1-1/2	3/8	4-9/16	B29D	1	
NYT3131		350 kcmil	2	2	2	1-1/2	3/8	5	B31D	2	
NYT3426	500 kcmil	2/0 AWG	1	1-3/8	1-1/2	1-5/8	3/8	4-7/16	B26D	1	
NYT3428		4/0 AWG	2	2	1-5/8	1-5/8	3/8	4-5/8	B28D	1	
NYT3429		250 kcmil	2	2	1-5/8	1-5/8	3/8	4-5/8	B29D	1	
NYT3431		350 kcmil	2	2	2	1-5/8	3/8	5-1/16	B31D	2	
NYT3434		500 kcmil	2	2	2-1/4	1-5/8	3/8	5-3/8	No Nest Die Req'd.	2	
NYT3926	750 kcmil	2/0 AWG	1	1-3/8	1-1/2	1-7/8	3/8	4-5/8	B26D	1	
NYT3928		4/0 AWG	2	2	1-5/8	1-7/8	3/8	4-13/16	B28D	1	
NYT3929		250 kcmil	2	2	1-5/8	1-7/8	3/8	4-13/16	B29D	1	
NYT3931		350 kcmil	2	2	2	1-7/8	3/8	5-1/4	B31D	2	
NYT3934		500 kcmil	2	2	2-1/4	1-7/8	3/8	5-9/16	No Nest Die Req'd.	2	
NYT3939		750 kcmil	2	2	2-7/8	1-7/8	3/8	6-1/4	—	2	
NYT4426	1000 kcmil	2/0 AWG	1	1-3/8	1-1/2	2-1/8	3/8	4-3/4	B26D	1	
NYT4428		4/0 AWG	2	2	1-5/8	2-1/8	3/8	4-15/16	B28D	1	
NYT4429		250 kcmil	2	2	1-5/8	2-1/8	3/8	5	B29D	1	
NYT4431		350 kcmil	2	2	2	2-1/8	3/8	5-7/16	B31D	2	
NYT4434		500 kcmil	2	2	2-1/4	2-1/8	3/8	5-3/4	No Nest Die Req'd.	2	
NYT4439		750 kcmil	2	2	2-7/8	2-1/4	3/8	6-3/8	—	2	
NYT4444		1000 kcmil	2	2-11/16	3	2-5/16	1/2	7	—	2	
NYT4628	1500 kcmil	4/0 AWG	2	2	1-5/8	2-11/16	3/8	5-3/8	B28D	1	
NYT4629		250 kcmil	2	2	1-5/8	2-11/16	3/8	5-7/16	B29D	1	
NYT4631		350 kcmil	2	2	2	2-11/16	3/8	5-7/8	B31D	2	
NYT4634		500 kcmil	2	2	2-1/4	2-11/16	3/8	6-3/16	No Nest Die Req'd.	2	
NYT4639		750 kcmil	2	2	2-7/8	2-11/16	3/8	6-3/4	—	2	
NYT4644		1000 kcmil	2	2	3	2-3/4	1/2	7-1/8	—	2	
NYT4646		1500 kcmil	2	2-11/16	3-3/16	2-3/4	1/2	7-11/16	—	2	

High Capacity Limiter - 200,000 Amperes at 600 Volts

The BURNDY® High Capacity Limiter is designed to economically protect electrical distribution systems from the destructive effect of high energy faults. The increasing number of 600 volt secondary network installations for industrial and commercial applications demand a cable limiter that can safely interrupt 200,000 amperes (symmetrical available) and one that will also completely coordinate with the higher voltage network protector fuses.

Available fault currents as high as 200,000 amperes rms at 600 volts across the fusible elements have been interrupted during tests on the BURNDY® High Capacity Limiter. The power factor during these tests was less than 15%, thereby imposing the most difficult clearing conditions. No external disturbance is experienced upon clearing fault currents from the "float" value to 200,000 amperes. The quartz tiller absorbs the intense energy generated by interrupting the fault current. The quartz fuses into tubular fulgurites, with a high dielectric strength, and forms an insulating barrier between the melted link sections. This action prevents restrike of the internal arc. The rugged aluminum housing and cast epoxy end seals provide a vessel that completely contains the developed energy.

The carefully developed time-current characteristics and rigid manufacturing tolerances assure proper coordination with the network protector fuses and the insulation damage characteristics of 4/0, 250, 350, 500 kcmil and 750 cable.

The High Capacity Limiter is available in four variations to accommodate a variety of installation practices. The Type HYS cable sockets at both ends, which allow for indenting to the cable ends with a hydraulic BURNDY® HYPRESS™. The HYA has an off-set lug on one end which permits back-to-back mounting on bus bar. They HYA also allows cable to installation with no off-set.

For those installations where BURNDY® MOLE™ connections are used for manhole junctions or transformer vault buses, the Type HYM permits a replaceable connection of the limiter director to the MOLE™ outlet at one end and a compression cable connection at the other.

Modern electrical distribution systems require low cost protection to safeguard costly equipment and quickly isolate faults, so that the undamaged portions of the system may function normally. BURNDY® High Capacity Limiters assure positive, economical protection when installed in properly designed systems.

NOTE: Today's fault currents are growing. If you need higher fault current ratings, please contact the factory.

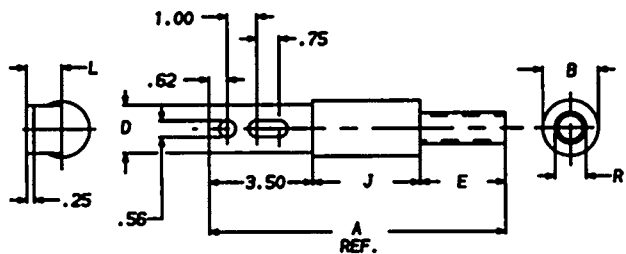

Offset Bus to Cable
Type HYAO
Figure 1

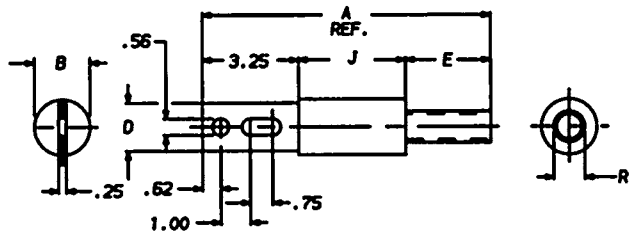

Bus to Cable
Type HYA
Figure 2

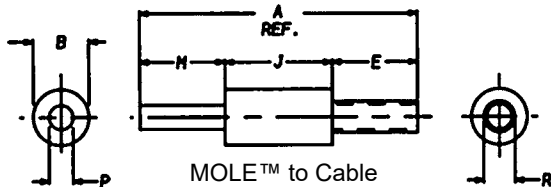

MOLE™ to Cable
Type HYM
Figure 3

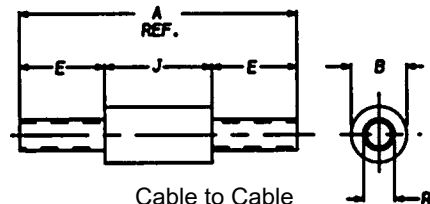

Cable to Cable
Type HYS
Figure 4

High Capacity Limiter 200,000 Amperes at 600 Volts

④ Catalog Number	Cable Size	Fig. No.	A		B		D		E		J		L		M		P		R		Die Index	Die	No. of Crimps per End
			In	mm	In	mm	In	mm	In	mm	In	mm	In	mm	In	mm	In	mm	In	mm			
H Yao_28	4/0	1	8.87	225	1.44	37	1.12	28	1.75	44	3.62	92	0.96	24	—	—	—	—	0.68	17	15	U28RT	2
H Yao_29	250 kcmil	1	9.00	229	1.44	37	1.12	28	1.88	48	3.62	92	0.96	24	—	—	—	—	0.75	19	16	U29RT	2
H Yao_31	350 kcmil	1	9.12	232	1.62	41	1.12	28	2.00	51	3.62	92	0.96	24	—	—	—	—	0.88	22	18	U31RT	4
H Yao_34	500 kcmil	1	10.00	254	1.88	48	1.62	41	2.88	73	3.62	92	1.19	30	—	—	—	—	1.05	27	20	U34RT	4
H Yao_39	750 kcmil	1	10.13	257	2.50	64	2.00	51	2.88	73	3.75	95	1.31	33	—	—	—	—	1.32	34	24	U39RT	4
H YA_28	4/0	2	8.62	219	1.44	37	1.12	28	1.75	44	3.62	92	—	—	—	—	—	—	0.68	17	15	U28RT	2
H YA_29	250 kcmil	2	8.75	222	1.44	37	1.12	28	1.88	48	3.62	92	—	—	—	—	—	—	0.75	19	16	U29RT	2
H YA_31	350 kcmil	2	8.87	225	1.62	41	1.12	28	2.00	51	3.62	92	—	—	—	—	—	—	0.88	22	18	U31RT	4
H YA_34	500 kcmil	2	9.75	248	1.88	48	1.62	41	2.88	73	3.62	92	—	—	—	—	—	—	1.05	27	20	U34RT	4
H YA_39	750 kcmil	2	9.88	251	2.50	64	2.00	51	2.88	73	3.75	95	—	—	—	—	—	—	1.32	34	24	U39RT	4
H YM_28	4/0	3	7.87	200	1.44	37	—	—	1.75	44	3.62	92	—	—	2.50	64	0.52	13	0.68	17	15	U28RT	2
H YM_29	250 kcmil	3	8.00	203	1.44	37	—	—	1.88	48	3.62	92	—	—	2.50	64	0.58	14	0.75	19	16	U29RT	2
H YM_31	350 kcmil	3	8.12	206	1.62	41	—	—	2.00	51	3.62	92	—	—	2.50	64	0.68	17	0.88	22	18	U31RT	4
H YM_34	500 kcmil	3	9.38	238	1.88	48	—	—	2.88	73	3.62	92	—	—	2.88	73	0.81	21	1.05	27	20	U34RT	4
H YM_39	750 kcmil	3	9.51	242	2.50	64	—	—	2.88	73	3.75	95	—	—	2.88	73	1.00	25	1.32	34	24	U39RT	4
H YS_28	4/0	4	7.12	180	1.44	37	—	—	1.75	44	3.62	92	—	—	—	—	—	—	0.68	17	15	U28RT	2
H YS_29	250 kcmil	4	7.38	188	1.44	37	—	—	1.88	48	3.62	92	—	—	—	—	—	—	0.75	19	16	U29RT	2
H YS_31	350 kcmil	4	7.62	194	1.62	41	—	—	2.00	51	3.62	92	—	—	—	—	—	—	0.88	22	18	U31RT	4
H YS_34	500 kcmil	4	9.38	238	1.88	48	—	—	2.88	73	3.62	92	—	—	—	—	—	—	1.05	27	20	U34RT	4
H YS_39	750 kcmil	4	9.51	242	2.50	64	—	—	2.88	73	3.75	95	—	—	—	—	—	—	1.32	34	24	U39RT	4

Notes:

1. For insulated version add suffix "-C" to Catalog Number (example: HYMS34C).
2. High Capacity Limiter. 200kA interrupting capacity at 600V AC.
3. Cable end utilize dies with 35, 46, 45, and 750 series tools (750 kcmil size units cannot be installed with the 35 Series tools).
- ④ For fast operating limiter use "F"; for slow or standard operating limiter use "S" before conductor number (example: HYMF34 or HYMS34) see Time-Current Characteristics.
5. For other conductor sizes, contact the factory.

For over 85 years, BURNDY has pioneered and produced economical, dependable connectors and protective devices for urban underground distribution systems. This extensive experience has been applied to the development of equipment for low cost underground distribution systems for light commercial and residential areas.

Increasing interest by home buyers and developers has created a need for URD components comparable in cost with those used in overhead systems.

Using connectors designed for other purposes, early URD installations were relatively expensive. Recognizing the need to reduce installation costs, BURNDY developed a line of connectors specifically for URD.

These products are shown in this section. They are the result of a continuing search for new materials and more efficient production methods to bring down cost to meet the requirements of low cost underground construction.

Type RDMD-2858D
Stud MOLE™ Junction with Adapter

The RDMD-2858D Stud MOLE™ is identical to the insulated RDMD-28G except an adapter is supplied, allowing MOLE™ to be removed from transformer stud without disconnecting the individual services.

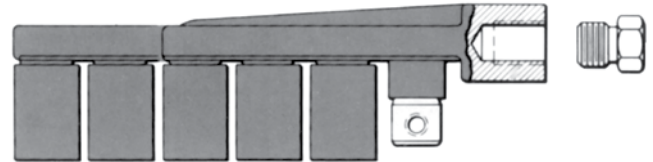

Catalog Number	Number of Outlets	Insulated
RDMD42858D	4	Yes

Type RDM-28
URD MOLE™ for Aluminum or Copper

Type RDM-28 MOLE™ is an economical, insulated, submersible service junction suitable for direct burial or for use in enclosures. Disconnectable joints allow additions of new services without disturbing previous installations. Taping is eliminated, heat-shrink or force-fit rubber sleeves insulate each joint. Rubber is used to insulate the MOLE™ body. Removable sealing covers are supplied on all outlets but two. REA listed Tap Kits, including HYLUG™, hardware and sleeve are ordered separately.

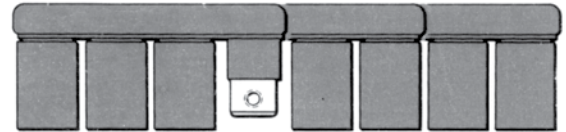

Catalog Number	Number of Outlets
RDM428	4
RDM628	6
RDM828	8

Types RA6UC-SL, RA6UCR-SL
URD Street Lighting Tap Kit for Aluminum or Copper

URD tap kit for making street lighting taps from URD MOLE™ types RDM-28 and RDM-28T. Each kit accommodates 6 str. - 12 sol. Kits include connector, mounting hardware and insulating sleeve.



Catalog Number		Conductor
Heat Shrink	Force Fit	
RA6UCSL	RA6UCRSL	6 Str. - 12 Sol.

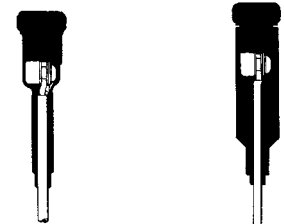

MOLE™ Tap Kits, Types RYA-UC, RYA-AC

For Aluminum or Copper with Type RDM-28
URD MOLE™

The kit consists of Universal HYLUG™, mounting hardware and heat-shrink sleeve. The HYLUG™ is pre-filled with PENETROX™ joint compound and sealed. Installed with common installation tools, three die sets install a range of 4 str.-350 kcmil. The heatshrink sleeve is lined with a mastic material, providing a positive seal. Installed with standard propane torch, or 500°F electric heat gun. Acetylene heat is too intense and is not recommended.



TYPES RYA-UC, RYA-AC



TYPES RYA-UCR, RYA-ACR

MOLE™ Tap Kits, Types RYA-UCR, RYA-ACR

With Force Fit Rubber Sleeve

The kit consists of Universal HYLUG™, mounting hardware and pre-lubricated force fit rubber sleeve. The HYLUG™ is pre-filled with PENETROX™ joint compound and sealed. Installed with common installation tools, three die sets install a range of 4 str.-350 kcmil. The rubber sleeve has internal sealing rings that provide a positive moisture seal by exerting circumferential force on cable and MOLE™ insulation. Pre-lubricating sleeve makes installation easier. REA listed. No trimming required.

Catalog Number			Conductor		EEI Die Index	Die Index	Tools, Die Set Catalog Number & (Number of Crimps)		
Heat Shrink Complete Set	Shrink Sleeve Only	Force Fit Complete Set	Copper	Aluminum			MD6 Series	35, 750 Series	OUR840
RYA4UC	RYAC25	RYA4UCR	2 Sol.-4 Str.	2 Sol. - 4 Str. 4 Str. Comp	8A	BG or 5/8-1 or 243	WBG (1) BG3 or W243	UBG (1) UK581T (3) U243 (1)	XBG (3) XNBG (2)
RYA2UC	RYAC25	RYA2UCR	2 Str. - 1/0 Sol.	2 Str. - 1/0 Sol. 2-1 Str. Comp					
RYA25UC	RYAC25	RYA25UCR	1/0 Str.	1/0 Str. - 2/0 Sol. 1/0 Str. Comp.					
RYA2WAC	RYAC25	RYA2WACR	—	2 Sol. EC-O	—	BG	BG (5)	—	XBG (5) XNBG (3)
RYA75AC	RYAC25	RYA75ACR	—	1/0 Sol. EC-O	—	—	—	UK581T (5)	XNBG (3)
RYA26UC	RYAC31	RYA26UCR	2/0 Str.	2/0 Str. 2/0 Str. Comp.	11	249 or 840	W249 (3) WK840 (5)	U249 (2) UK840T (3)	X249 (6) X840 (5)
RYA27UC	RYAC31	RYA27UCR	3/0 Str.	3/0 Str. 3/0 Str. Comp. 4/0 Sol. EC-O	11				
RYA28UC	RYAC31	RYA28UCR	4/0 Str.	4/0 Str. 4/0 Str. - 250 Comp.	11				
RYA29UC	RYAC31	RYA29UCR	250 kcmil	250 250 Comp.	13A	299 or 655 or 705	—	U31ART (2) U655 (3) U705 (2)	—
RYA31AC	RYAC31	RYA31ACR	—	300 - 350 300 - 350 Comp.	13A				

* Overlap Crimps.

** Do not use EEI Die. (11A) to install 4/0 Sol. EC-O.

NOTE: Standard mounting hardware is 3/8" button head socket cap screw with captive conical washer. For HEX HEAD bolt with captive conical washer add "HEX" suffix.

Example:

RYA4UCR-HEX. For HEX HEAD bolt and captive flat washer add suffix "HEX1".

For HEX HEAD bolt and non-captive flat washer add suffix "HEX2".

For HEX HEAD bolt and non-captive conical washer add suffix "HEX3".

For Stainless Steel HEX HEAD bolt add "HEX355" suffix.

URD Insulated Splice Kit, Type YS-CG
For All Aluminum or Copper/Aluminum Combinations

Type YS-CG URD insulated splice kit consists of a standard YSU or YSD LINKIT™ and a heat-shrink sleeve. Used to splice URD secondary lines up to 600 volts. It is installed with common installation tools. Heat-shrink sleeve is installed with standard propane torch, or 500° F electric heat gun. Acetylene is not recommended.

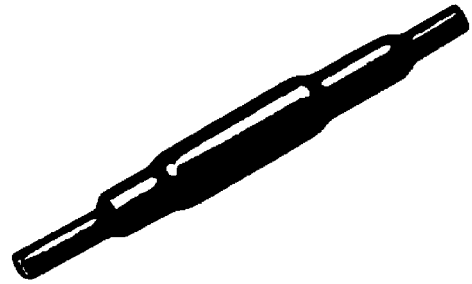

Catalog Number		Conductor			Die Index	Tools, Die Set Catalog Number, & (No. of Crimps)	
Complete Splice Kit	Heat Shrink Sleeve	Both Sides				MD6 Series	35, 750 Series
		Aluminum	ACSR	Copper *			
YS2UCG1	RYAC25	1-2 Str.	2 (6-1, 7-1)	1-2 Str.	BG 243	BG (3) WBG (1)** W243 (2)	UBG(1)** U243 (1)
YS25UCG1		1/0 Str. 1/0 Comp.	1/0 (6-1)	1/0 Str.			
YS26UCG1	RYAC311	2/0 Str. 2/0 Comp.	2/0 (6-1)	2/0 Str.	249/840	W249 (4) WK840 (7)	U249 (2) UK840T (4)
YS27UCG1		3/0 Str. 3/0 Comp.	3/0 (6-1)	3/0 Str.			
YS28UCG1		4/0 Str. 4/0 Comp.	4/0 (6-1)	4/0 Str.			
YS31ACG1	RYAC31	350 350 Comp.	—	350	299/705	—	U299 (2) U705 (1)

* Use to join copper to aluminum or ACSR not copper to copper.

** Multiple crimp die set makes more than one crimp per compression.

HYREDUCER™ Splice, Type YRB-U For Aluminum to Aluminum and Aluminum to Copper

Type YRB-U splice is designed for use within underground systems. Aluminum splices are tin-plated and recommended for use on Aluminum-to-Aluminum and Aluminum-to-Copper cables. All splices have solid center stop for use with oil filled and non-oil filled cables. The Outside Diameter is held constant to minimize installation dies and connectors are prefilled with PENETROX™. Rated up to 35 kV.

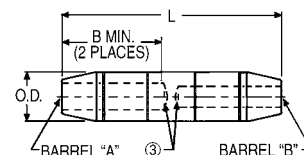

Catalog Number	Conductor Range		Dimensions		O.D.	Wire Strip Length		Die Index	Color Code
	Barrel "A" Copper & Aluminum	Barrel "B" Copper & Aluminum	B Min.	L		Barrel "A"	Barrel "B"		
YRB2U3TTN	#2 (.292 Dia.) 7 Str.	#3 (.260 Dia.) 7 Str.	1.35 [34]	3.25 [83]	0.65 [17]	1-3/4"	1-3/4"	296	Tan
YRB1CU2TTN	#1 (.332 Dia.) 19 Str. or 1/0 Compact (.336 Dia.) 19 Str.	#2 (.292 Dia.) 7 Str.							
YRB1CU1TTN	#1 (.332 Dia.) 19 Str. or 1/0 Compact (.336 Dia.) 19 Str.	#1 (.332 Dia.) 19 Str. or 1/0 Compact (.336 Dia.) 19 Str.							
YRB25U3TTN	1/0 (.373 Dia.) 19 Str. or 1/0 Compact (.336 Dia.) 19 Str.	#3 (.260 Dia.) 7 Str.							
YRB25U2TTN	1/0 (.373 Dia.) 19 Str. or 1/0 Compact (.336 Dia.) 19 Str.	#2 (.292 Dia.) 7 Str.							
YRB25U25TTN	1/0 (.373 Dia.) 19 Str. or 1/0 Compact (.336 Dia.) 19 Str.	1/0 (.373 Dia.) 19 Str. or 1/0 Compact (.336 Dia.) 19 Str.							
YRB27U25TW	3/0 (.470 Dia.) 19 Str. or 3/0 Compact (.423 Dia.) 19 Str.	1/0 (.373 Dia.) 19 Str. or 1/0 Compact (.336 Dia.) 19 Str.	1.53 [39]	3.69 [94]	0.85 [22]	1-1/2"	1-1/2"	298	White
YRB28U3TW	4/0 (.528 Dia.) 19 Str. or 4/0 Compact (.475 Dia.) 19 Str.	#3 (.260 Dia.) 7 Str.							
YRB28U1TW	4/0 (.528 Dia.) 19 Str. or 4/0 Compact (.475 Dia.) 19 Str.	#1 (.332 Dia.) 19 Str. or 1/0 Compact (.336 Dia.) 19 Str.							
YRB28U25TW	4/0 (.528 Dia.) 19 Str. or 4/0 Compact (.475 Dia.) 19 Str.	1/0 (.373 Dia.) 19 Str. or 1/0 Compact (.336 Dia.) 19 Str.							
YRB28U26TW	4/0 (.528 Dia.) 19 Str. or 4/0 Compact (.475 Dia.) 19 Str.	2/0 (.419 Dia.) 19 Str. or 2/0 Compact (.376 Dia.) 19 Str.							
YRB28U28TW	4/0 (.528 Dia.) 19 Str. or 4/0 Compact (.475 Dia.) 19 Str.	4/0 (.528 Dia.) 19 Str. or 4/0 Compact (.475 Dia.) 19 Str.							
YRB31U25TW	350 kcmil (.681 Dia.) 37 Str. or 350 kcmil Compact (.616 Dia.) 19 Str. Al; 37 Str. Al & Cu	1/0 (.373 Dia.) 19 Str. or 1/0 Compact (.336 Dia.) 19 Str.	2.34 [59]	5.43 [138]	1.11 [28]	2-1/4"	2-1/4"	299	Brown
YRB31U28TW	350 kcmil (.681 Dia.) 37 Str. or 350 kcmil Compact (.616 Dia.) 19 Str. Al; 37 Str. Al & Cu	4/0 (.528 Dia.) 19 Str. or 250 kcmil Compact (.520 Dia.) 37 Str.							
YRB31U31TW	350 kcmil (.681 Dia.) 37 Str. or 350 kcmil Compact (.616 Dia.) 19 Str. Al; 37 Str. Al & Cu	350 kcmil (.681 Dia.) 37 Str. or 350 kcmil Compact (.616 Dia.) 19 Str. Al; 37 Str. Al & Cu							

1. Material: Aluminum.
2. Finish: Electro-tin plated.
3. Barrels are partially filled with PENETROX™ and sealed.
4. Scratch brushing of all conductors before making installation is recommended.
5. Not for use with Copper-to-Copper applications.
6. Dimensions in brackets [] are in millimeters rounded off to the nearest millimeter, unless otherwise noted and are for reference only.
7. Catalog number PT6515 Adaptor is required to use "U" dies in 45 series tools.
8. Catalog number PUADP1 Adaptor is required to use "U" dies in 46 series tools.
9. On MY293 HYTOOL™ use alum. Index plate settings as follows, for 1/0 conductor use 1/0 setting. For conductor smaller than 1/0 size use 2/0 setting.

HYREDUCER™ Splice, Type YRB-U
(Continued)

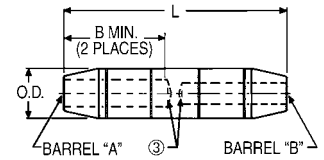

Catalog Number	Conductor Range		Dimensions		O.D.	Wire Strip Length		Die Number	Color Code
	Barrel "A" Copper & Aluminum	Barrel "B" Copper & Aluminum	B Min.	L		Barrel "A"	Barrel "B"		
YRB34U25TW	500 kcmil (.813 Dia.) 37 Str. or 500 kcmil Compact (.736 Dia.) 19 Str. Al; 37 Str. Al & Cu	1/0 (.373 Dia.) 19 Str.	2.70 [69]	6.00 [152]	1.31 [33]	1-1/8"	1-1/8"	300	Pink
YRB34U28TW	500 kcmil (.813 Dia.) 37 Str. or 500 kcmil Compact (.736 Dia.) 19 Str. Al; 37 Str. Al & Cu	4/0 (.528 Dia.) 19 Str. or 4/0 Compact (.475 Dia.) 19 Str.							
YRB34U29TW	500 kcmil (.813 Dia.) 37 Str. or 500 kcmil Compact (.736 Dia.) 19 Str. Al; 37 Str. Al & Cu	250 kcmil (.575 Dia.) 37 Str.							
YRB34U30TW	500 kcmil (.813 Dia.) 37 Str. or 500 kcmil Compact (.736 Dia.) 19 Str. Al; 37 Str. Al & Cu	300 kcmil (.630 Dia.) 37 Str.							
YRB34U31TW	500 kcmil (.813 Dia.) 37 Str. or 500 kcmil Compact (.736 Dia.) 19 Str. Al; 37 Str. Al & Cu	350 kcmil (.681 Dia.) 37 Str. or 350 kcmil Compact (.616 Dia.) 19 Str. Al; 37 Str. Al & Cu							
YRB34U34TW	500 kcmil (.813 Dia.) 37 Str. or 500 kcmil Compact (.736 Dia.) 19 Str. Al; 37 Str. Al & Cu	500 kcmil (.813 Dia.) 37 Str. or 500 kcmil Compact (.736 Dia.) 19 Str. Al; 37 Str. Al & Cu							
YRB39U31TW	700 kcmil (.964 Dia.) 61 Str., 750 kcmil (.998 Dia.) 61 Str. or 750 kcmil Compact (.908 Dia.) 61 Str.	350 kcmil (.681 Dia.) 37 Str. or 350 kcmil Compact (.616 Dia.) 19 Str. Al; 37 Str. Al & Cu	2.87 [73]	6.74 [171]	1.46 [37]	3"	3-11/16"	936	Yellow
YRB39U34TW	700 kcmil (.964 Dia.) 61 Str., 750 kcmil (.998 Dia.) 61 Str. or 750 kcmil Compact (.908 Dia.) 61 Str.	500 kcmil (.813 Dia.) 37 Str. or 500 kcmil Compact (.736 Dia.) 19 Str. Al; 37 Str. Al & Cu							
YRB39U39TW	700 kcmil (.964 Dia.) 61 Str., 750 kcmil (.998 Dia.) 61 Str. or 750 kcmil Compact (.908 Dia.) 61 Str.	700 kcmil (.964 Dia.) 61 Str., 750 kcmil (.998 Dia.) 61 Str. or 750 kcmil Compact (.908 Dia.) 61 Str.							
YRB44U31TW	1000 kcmil (1.152 Dia.) 61 Str.	350 kcmil (.681 Dia.) 37 Str. or 350 kcmil Compact (.616 Dia.) 19 Str. Al; 37 Str. Al & Cu							
YRB44U34TW	1000 kcmil (1.152 Dia.) 61 Str.	500 kcmil (.813 Dia.) 37 Str. or 500 kcmil Compact (.736 Dia.) 19 Str. Al; 37 Str. Al & Cu							
YRB44U39TW	1000 kcmil (1.152 Dia.) 61 Str.	700 kcmil (.964 Dia.) 61 Str., 750 kcmil (.998 Dia.) 61 Str. or 750 kcmil Compact (.908 Dia.) 61 Str.							
YRB44U44TW	1000 kcmil (1.152 Dia.) 61 Str.	1000 kcmil (1.152 Dia.) 61 Str.							

1. Material: Aluminum.
2. Finish: Electro-tin plated.
3. Barrels are partially filled with PENETROX™ and sealed.
4. Scratch brushing of all conductors before making installation is recommended.
5. Not for use with Copper-to-Copper applications.
6. Dimensions in brackets [] are in millimeters rounded off to the nearest millimeter, unless otherwise noted and are for reference only.
7. Catalog number PT6515 Adaptor is required to use "U" dies in 45 series tools.
8. Catalog number PUADP1 Adaptor is required to use "U" dies in 46 series tools.
9. On MY293 HYTOOL™ use alum. Index plate settings as follows, for 1/0 conductor use 1/0 setting. For conductor smaller than 1/0 size use 2/0 setting.

HYREDUCER™ Splice, Type YRB-U (Continued)

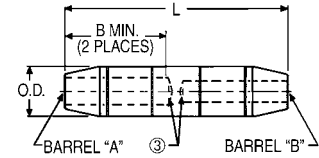

Installation (Number of Crimps per End)						
Color Code	Die Index	Hydraulic				Dieless (# of Crimps)
		35, 750 Series	46 Series	45 Series	60 Ton Series	
Tan	296	U25ART (1)	U25ART (1)	U25ART (1)	—	Mechanical: MY29 Series (1) Hydraulic: 644 Series (1), 444 Series (1)
White	298	U28ART (2)	U28ART (2)	U28ART (2)	—	
Brown	299	U31ART Overlap Crimp	U31ART Overlap Crimp	U31ART Overlap Crimp	L31ART (1)	644 Series (1) 444 Series (1)
Pink	300	U34ART Overlap Clamp	U34ART Overlap Clamp	U34ART Overlap Clamp	L34ART	
Yellow	936	U39ART2 (4)	U39ART2 (4)	U39ART2 (4)	L39ART (2)	—

1. Material: Aluminum.
2. Finish: Electro-tin plated.
3. Barrels are partially filled with PENETROX™ and sealed.
4. Scratch brushing of all conductors before making installation is recommended.
5. Not for use with Copper-to-Copper applications.
6. Dimensions in brackets [] are in millimeters rounded off to the nearest millimeter, unless otherwise noted and are for reference only.
7. Catalog number PT6515 Adaptor is required to use "U" dies in 45 Series tools.
8. Catalog number PUADP1 Adaptor is required to use "U" dies in 46 Series tools.
9. On MY293 HYTOOL™ use alum. Index plate settings as follows, for 1/0 conductor use 1/0 setting. For conductor smaller than 1/0 size use 2/0 setting.

HYREDUCER™ Splice, Type YRB-T
For Copper to Copper

Type YRB-T splice is designed for use within underground systems. Copper splices are tapered and recommended for use on copper-to-copper cables.

All splices have solid center stops for use with oil filled and non-oil filled cables.

The Outside Diameter is held constant to minimize installation dies. Rated up to 35 kV

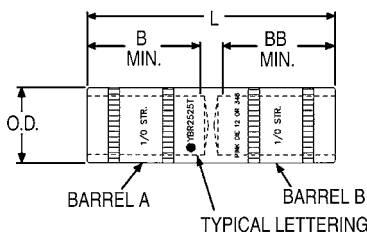

Fig. 1

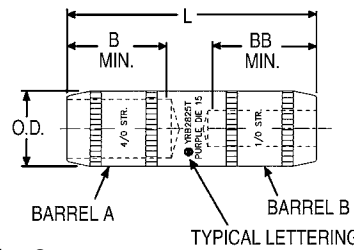

Fig. 2

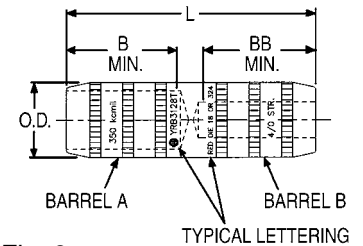

Fig. 3

Catalog Number ② ⑦	Figure No.	Conductor Size		Dimensions			
		Barrel "A"	Barrel "B"	B Min.	BB Min.	L	O.D.
YRB2825T	2	4/0 (0.53)	1/0 (0.37)	1.16 [29]	1.16 [29]	2.84 [73]	0.69 [18]
YRB3428T	3	500 kcmil	4/0 (0.53)	1.73 [44]	1.73 [44]	4.50 [114]	1.06 [27]

② ⑦ Catalog Number	Color Code	Installation Tooling (Number of Crimps)										Dieless (# of Crimps)	Wire Strip Length
		Die Information		Mechanical			Hydraulic						
		Die Index	Type	OUR840	MD7 MD734R	MD6	35, 750 Series	BCT500, Y500CT	④ 46 Series	③ 45 Series	60 Series		
YRB2825T	Purple	Die 15	Purple Die Set	X28VT (4) X28RT (4)	X28VT (4)	X28VT (4)	U28RT (1)	—	U28RT (1)	—	L29ART (1)	Hydraulic: 644 Series (1) 444 Series (1)	1-7/32"
YRB3428T	Brown	Die 20 or 299	Brown Die Set	—	—	—	U34ART (2) U31ART (2)	W34VT (2) W34RT (2)	U34RT (2) U31ART (2)	U34RT (2) U31ART (2)	L34RT (1)	Hydraulic: 644 Series (1) 444 Series (1)	1-13/16"

- 1 Material: Copper.
- ② For Tin-Plating, add suffix "TN" to the Catalog Number (example: YRB2825TN). For Hot Tin dipped add suffix "W" to the catalog number (example: YRB2825TW).
- ③ Catalog number PT6515 Adaptor is required to use "U" type dies in the 45 series tools
- ④ Catalog number PUADP1 Adaptor is required to use "U" type dies in the 46 series tools
- 5 Dimensions in brackets [] are in millimeters rounded off to the nearest millimeter, unless otherwise specified, and are for reference only.
- ⑦ Suffix "TN" and "W" will not be stamped on part.

URD Service Tap, Type K-P-C For Copper Conductors

These compact, wide-range-taking, multiple outlet connectors are made of high conductivity copper alloy. Spherical point Allen set screws provide even clamping forces on conductors up to 4/0 Str. Each connector is supplied with an insulating cover. The mechanical clamping elements allow individual cables to be disconnected without disturbing adjacent connections.

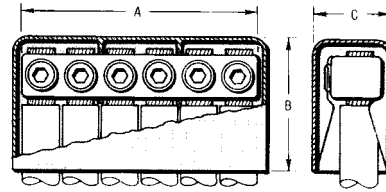

Catalog Number			Conductor	Number of Outlets	A	B	C
Complete Assembly	Connector Only	Cover Only					
K6P28C	K6P28	KPC28	6 Str - 4/0 Str.	6	5-1/8	2-3/4	1-5/8

Table of Contents

Fundamentals of BURNDY Substation Catalog Numbering System.....	L-3
BURNDY Catalog Numbering Alpha Character Designations.....	L-4
Catalog Number Conductor Identification.....	L-5
Connector Material Identification	L-6
Terminal Pad Configurations and Catalog Number Designations	L-7
Catalog Number Suffixes, Plating, Hardware, etc.	L-8
Stud Connector Catalog Numbering	L-9
Type FCB Type E-C-G; Transformer Tap Adapters.....	L-10
Type NBXR Bolted Terminals (copper pipe or cable to pad)	L-11
Type NAS Bolted Terminals (copper cable to pad).....	L-12
Type NA Bolted Terminals (copper tube to pad)	L-13
Type NAH Bolted Terminals (copper cable to pad)	L-14
Type N2AH Bolted Terminals (two copper cables to pad)	L-15
Type VVA VARILUG™ Terminals (copper cable to pad)	L-16
Type VV2A VARILUG™ Terminals (two copper cables to pad).....	L-17
Type VV3A VARILUG™ Terminals (three copper cables to pad)	L-18
Type NAR Aluminum Terminals (cable to pad).....	L-19
Type NBC-A Aluminum T Terminals (tube to centerline tap pad).....	L-20
Type NA-A Aluminum Terminals (tube to pad).....	L-21
Type STS-A-NCG Terminal Pad Cap (one piece)	L-21
Type NS Copper Bolted Couplers, (copper straight tube to tube).....	L-22
Type NS-A Aluminum Couplers (aluminum tube to tube)	L-23
Type NT T-Connectors (copper tube to tube).....	L-24
Type NSNT T-Connectors (copper tube or cable to cable).....	L-25
Type NHNT T-Connector Terminals (copper tube to cable)	L-26
Type VT T-Connectors (copper cable to cable)	L-27
Type NNT Aluminum T-Connectors (aluminum and copper tube to tube).....	L-28
Type NNTR Aluminum T-Connectors (cable to cable)	L-29

Table of Contents

Type NNTR Aluminum T-Connectors (tube to cable).....	L-30
Type UH Copper Bus Supports (supporting copper tube to base).....	L-31
Type UHR Copper Bus Supports (supporting copper cable or tube to base).....	L-31
Type LH Bus Supports (supporting copper cable or tube to base).....	L-32
Type UHG Aluminum Bus Supports (fixed or rigid pipe to base).....	L-33
Type UHKR-A Aluminum Bus Supports (cable or tube to base).....	L-34
Type LB-A Aluminum End Caps (tube end cap).....	L-35
Type NDR Copper Stud Connectors (copper stud to cable, tube, flat bar).....	L-36
Type FD Stud Connectors (copper stud to pad).....	L-37
Type VV3D-R Stud Connectors (stud to three cables - flag).....	L-38
Type SFD Stud Connectors (stud to pad).....	L-39
Type CPR-A Aluminum Spacers (two cable rigid spacer).....	L-40
Type S2GGBP-A Spacers (two cables rigid spacer with grounding bar).....	L-40
Type QGFL BARTAP™ Connectors (copper cable to flat).....	L-41
Type NFXR Bolted Terminals (pipe or cable to flat).....	L-42
Type HFBW Bar Clamps (copper bar to bar).....	L-43
Type HFB-P1 Bar Clamp Assembly Components (copper bar to bar).....	L-44
Type HFB-N Bar Clamp Tap Pad Adapters (copper bar to pad).....	L-44

**Numerous Additional Connection Options Are Available.
Contact Customer Service
or
View the BURNDY Substation Catalog for
Additional Information**

Fundamentals of BURNDY Substation Catalog Numbering System:

Over the years, BURNDY has established an alpha-numeric catalog numbering system/structure to help describe a connector's specific use/application and type or features about the connector. This resource section should be used as a catalog numbering **guideline**. Over the years there have been many exceptions made to the BURNDY Substation Catalog Number System Structure.

The basic anatomy of a catalog number is dependent on the product family, as each family of connectors has different uses / applications and types / features. Because each product family has different uses and types, each product family's numbering scheme may have different attributes to help describe the connector. Below are a few examples of the basic alpha-numeric catalog numbering structure for six different product families.

Product Family				Terminal / Tap
Family	Conductor	Pad	Suffix	
NA	19	A4	GS	
Catalog number structure				NA19A4GS

Product Family				T-Connector
Family	Run	Tap	Suffix	
NT	16	34		
Catalog number structure				NT1634

Product Family				Bus Support
Family	Conductor	Bolt Circle	Suffix	
UHG	20A	3		
Catalog number structure				UHG20A3

Product Family				Coupler
Family	Run	Tap	Suffix	
NL	14	14	8HC	
Catalog number structure				NL14148HC

Product Family				Stud Connector
Family	Stud	Conductor	Suffix	
NDR	655	34	T12	
Catalog number structure				NDR65534T12

Product Family				Spacer
Family	Conductor	Spacing	Suffix	
CP	40A	L4		
Catalog number structure				CP40AL4

BURNDY Catalog Numbering Alpha Character Designations:

Having a fundamental understanding of the alpha character designations is important when trying to interpret the product family, which typically identifies the connector's "use" and "type". Because some alpha characters are used more than once to represent different meanings or as a place holders for product differentiation, it is important that this section be used as a **guideline**. Some alpha characters have two meanings, they can represent a connector's "use" or "type". A "use" designation (white background) would indicate the application the connector would be used in. A "type" designation (blue background) would indicate features about the connector to help describe the connector's function. Some catalog numbers have both "use" and "type" letters combined.

Terminal A	Tap B	Center Pad C	Stud Module D	Inline Coupler E	Flat Bar F
					
Grounding Stud G	Bus Support H	Heavy Duty H	Cable Expansion K	Elbow L	Body & Cap N
					
Ring shape (for Bus Sup.) O	Coupler P	Range Taking R	Streamlined S	Sliding Expansion S	T-Connector T
					
U-Shape U	V-Bolt (Clamping Element) V	Vertical Bus Sup. V	Weldment (Compression) W	Expansion X	Compression Y
					

Catalog Number Conductor Identification:

Non-Range Taking Connectors:

Typically, following the product family is the conductor size. Depending on the connector family, some connectors accommodate more than one conductor and may list two conductor sizes in the catalog number.

Range Taking Connectors:

Many substation connectors have range taking features. Range taking features allow a connector to accommodate various sizes of conductors. When a connector has a range taking feature, the catalog number will identify the largest conductor that the connector can accommodate.

Examples:



NT1514 (Non-Range Taking)
N = Cap & Body
T = T-Connector
15 = 1.00" IPS
14 = 3/4" IPS



VV3A4044N (Range Taking)
VV3 = V-Bolt (accommodating 3 conductors)
A = Terminal
40 = 800 kcmil*
44N = 4" pad with 4 hole NEMA drilling
***Range is 500 - 800 kcmil**



NAS292N (Range Taking)
N = Cap & Body
A = Terminal
S = Streamline
29 = 250 kcmil*
2N = 2 hole NEMA pad
***Range is 6 AWG - 250 kcmil**



NVTT1844 (Range Taking)
N = Cap & Body
V = V-Bolt
TT = T-Connector (2 "T" for 2 V-Bolts)
18 = 2.00" IPS (Non-Range Taking)
44 = 1,000 kcmil* (Range Taking)
***Range is 750 - 1,000 kcmil**

PLEASE NOTE:

BURNDY offers Substation connectors that can accommodate aluminum or copper pipe tubing and aluminum or copper cable and in some cases both pipe and cable conductor.

For current carrying purposes, BURNDY connectors are designed to comply with the NEMA CC1.

Connector Material Identification:

Following the conductor size in the catalog number is typically the material designation. When the conductor size is followed by the letter "A", this typically indicates that the connector is made from aluminum. When the conductor is not followed by the letter "A", this indicates that the connector is made of copper or bronze material. Note that in some cases the "A" is not used in the catalog number for aluminum. BURNDY offers Substation connectors that can accommodate aluminum or copper pipe tubing and aluminum or copper cable.

Examples:



NA194N - Copper Terminal
N = Cap & Body
A = Terminal
19 = 2.50" IPS
4N = 4 hole NEMA pad



NA19A4N - Aluminum Terminal
N = Cap & Body
A = Terminal
19 = 2.50" IPS
A = Aluminum
4N = 4 hole NEMA pad



NS1414 - Copper Coupler
N = Cap & Body
S = Streamline
14 = 3/4" IPS
14 = 3/4" IPS



NS14A14A - Aluminum Coupler
N = Cap & Body
S = Streamline
14 = 3/4" IPS
A = Aluminum
14 = 3/4" IPS
A = Aluminum

Terminal Pad Configurations & Catalog Number Designations:

Typically, at the very end of the catalog number is the pad configuration, unless there is a suffix. Terminal pads also have alpha-numeric designations to describe the pad configuration. The standalone or first number describes the number of holes and the second number describes the terminal pad width. The “N” following the number(s) indicates that the pad is a NEMA drilled pad. NEMA is a standard that defines the hole diameters and hole spacing. The table shows the most common terminal pad configurations and the catalog numbering identification alpha-numeric scheme.

Pad description block (regular)	Pad description block (FDs)	Figure	Holes configuration	C - Pad width
2N	B	1	2 holes NEMA	-
4N	-	2	4 holes NEMA	-
34N	C	2	4 holes NEMA	3"
44N	D	3	4 holes NEMA	4"
6N	-	4	6 holes NEMA	-
56N	E	4	6 holes NEMA	5"
66N	F	5	6 holes NEMA	6"

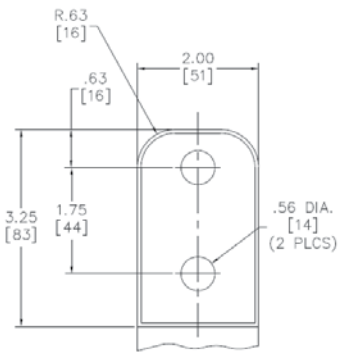

Figure 1

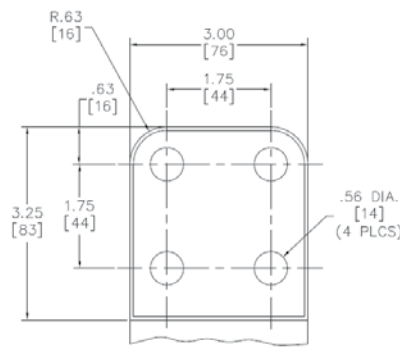

Figure 2

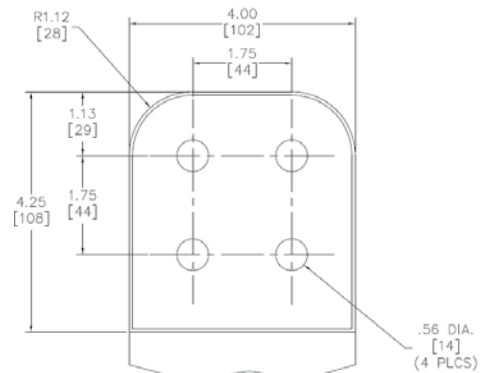

Figure 3

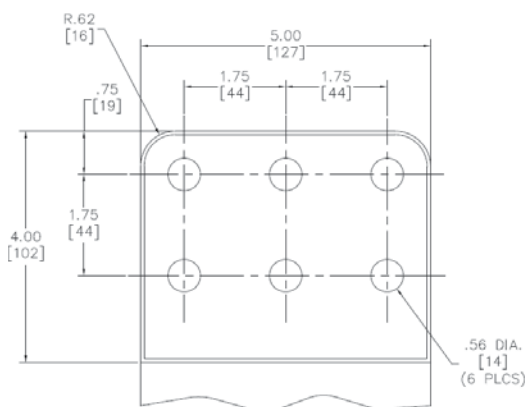

Figure 4

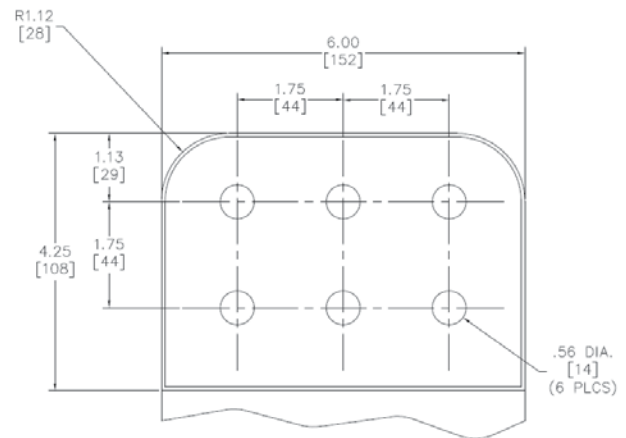

Figure 5

Catalog Number Suffixes:

Many catalog numbers have a suffix to provide additional information. The suffix could identify plating, hardware, operating voltages for streamlined connectors, etc. Below are tables listing the most common suffixes.

Plating Suffixes:

This table lists the most common plating suffixes found in the BURNDY Substation connector line.
Example: NAS292N vs. NAS292NTN (Tin plated version of the copper connector)

-TN	Electro tin plating
-BRTN	Bright electro tin plating
-W	Heavy duty electro tin plating (incl. hardware)
-SV	Silver plating
-NK	Nickel plating
-Q	Pad is finished on both sides (used in conjunction with other plating suffix)

Hardware Suffixes:

This table lists the most common hardware suffixes found in the BURNDY Substation connector offering. A catalog number with no hardware suffix will include the standard hardware for both copper and aluminum connectors.

Example: NNE14A34A vs. NNE14A34ASS (Coupler with Stainless Steel hardware)

-GS	Galvanized Steel hardware
-SS	Stainless Steel hardware
-BW	Belleville Washer
-CH	Antistatic Chatter Spring
-HC	Hex Captured hardware

Operating Voltage for Streamlined Connector Suffixes:

This table lists the most common operating voltage suffixes found in the BURNDY Substation offering.

Example: SNNE86A445A vs. SNNE86A445AS3 (S3 designates the terminal is rated for 345kV)

-S3	345kV rating
-K	cable versions for expansion items, 345kV
-S7	765V rating

G# and CG# Suffixes:

G# and CG# suffixes are used when a customer requests a connector that is similar to a product in the standard product offering, but deviates to be a standalone product within a particular family. To name these "special" connectors, BURNDY will add a G# or CG# suffix.

Example: NNE14A34AG1 or NNE14A34ACG1

Stud Connector Catalog Numbering:

Stud connectors have a different catalog numbering system in comparison to the other product families previous mentioned.

Examples:

Family	Stud Diameter	Pad Size	Pad thickness (in 1/16 of an inch)	Threads per inch of the stud (if different than 12)
FD	70	D	12	T14
Stud	3" Stud	4"x4" NEMA pad	12/16 = 3/4" thick tongue	14 threads per inch

FD70D12T14

F = Flat bar
 D = Stud module
 70 = 3" Stud size
 D = Pad size per Pad Description block
 12 = Tongue thickness (12/16" = 3/4" thick)
 T14 = 14 Threads per inch



Family	Stud Diameter	Conductor	Threads per inch of the stud (if different than 12)
NDR	63	28	T13
Stud	1/2" Stud	4/0	13 threads per inch

NDR6328T13

N = Body & Cap
 D = Stud module
 R = Range taking
 63 = 1/2" Stud size
 28 = 4/0 (Range 6 AWG - 4/0)
 T13 = 13 Threads per inch



Transformer Tap Adapters, Type FCB For Copper and Aluminum Tap to Pad

Material: Copper

Cast in one piece from copper alloy. Transformer tap adapter designed to accommodate from 1 to 6 NEMA drilled copper or aluminum terminal taps from a single secondary transformer outlet. Tin-plated. Order mounting hardware and tap terminals separately.

Notes :

- Plated versions: add the required suffix to the catalog number. -TN for regular tin plating
- Please contact factory for other sizes, combinations and availability

Catalog Number	Fig. No.	A Diameter	H Ref.	L	P
FCB634N	1	0.50	5.25	3.75	2.25
FCB636N	2	0.50	5.25	5.50	2.25
FCB644N	1	0.75	5.75	4.00	2.75
FCB646N	2	0.75	5.75	5.75	2.75
FCB654N	1	1.00	7.00	4.25	4.00
FCB632NP300	Not Shown	0.50	5.00	3.50	3.00
FCB644NP50	Not Shown	0.75	9.00	5.00	5.00

NOTE: All pads are NEMA drilled.

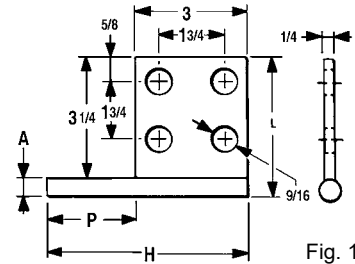

Fig. 1

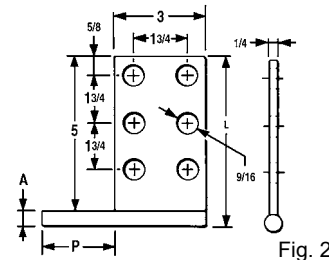

Fig. 2

Tap Adapters, Type E-C-G For Copper Cable to Tap

Material: Copper Alloy

Multi-tap, range-taking cast copper alloy connector designed to take 2, 3 or 4 conductors from a single secondary transformer outlet.

Notes :

- Plated versions: add the required suffix to the catalog number. -TN for regular tin plating
- Please contact factory for other sizes, combinations and availability

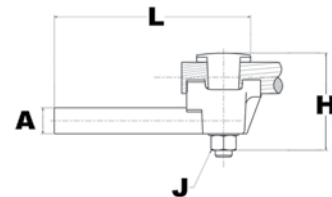
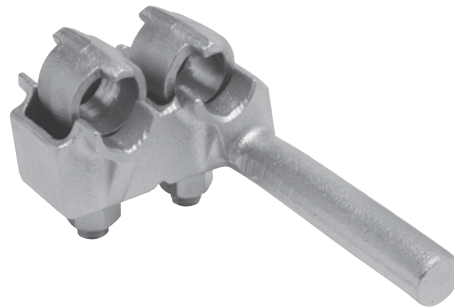

Fig.1

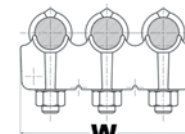

Fig.2

Catalog Number	Number of Conductors	Conductor Size	A Dia.	H	J	L	W
E2C34G1	2	1/0 -500 kcmil	0.78	3.88	1/2	6.25	3.50
E3C34G1	3						5.25
E4C34G1	4						6.88

Bolted Terminals, Type NBXR

For Copper Pipe or Cable to Pad

Material: Copper Alloy
Hardware: DURIMUM™ Silicon Bronze

One of the most versatile products available. Can be used in Terminal or Tap configuration with a large variety of cable and pipes.

Notes :

- Plated versions: add the required suffix to the catalog number. -TN for regular tin plating
- Please contact factory for other sizes, combinations and availability

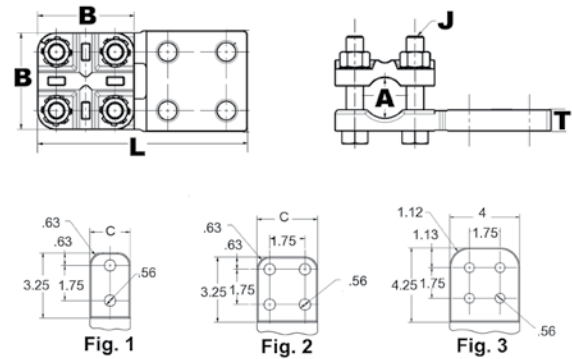

Catalog Number	Fig. #	Stranded Copper Cable	Copper Pipe (Std or EH)	B	T	L	C	J Dia.
NBXR1534NHQ	2	1/0 AWG-1250 kcmil	1/4 IPS -1 IPS	2.88	0.62	6.25	3.00	1/2
NBXR1544NHQ	3					7.19	4.00	
NBXR15CG1	2					6.25	3.00	

Bolted Terminals, Type NAS For Copper Cable to Pad

Material: Copper Alloy

Hardware: DURIMUM™ Silicon Bronze

High copper alloy reversible cap terminal for joining a wide range of cable to pads. Tongue is side formed to provide adequate clearance and terminal is designed for one-wrench installation.

Notes :

- Plated versions: add the required suffix to the catalog number. -TN for regular tin plating.
- Please contact factory for other sizes, combinations and availability.
- See NAH family for heavy duty versions.

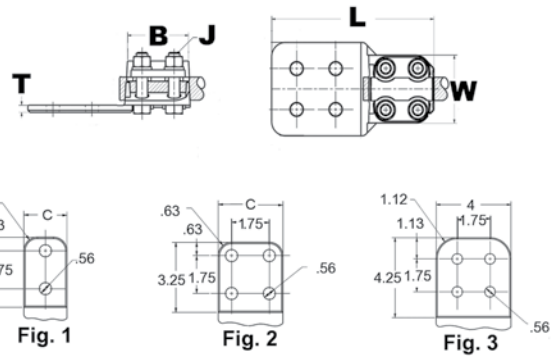
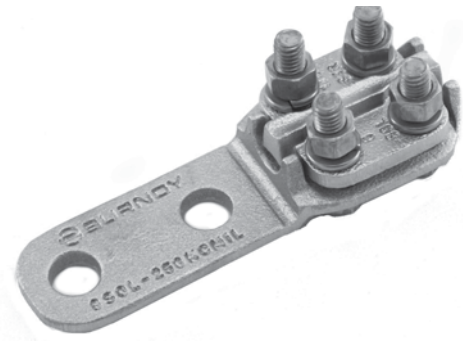

Catalog Number	Fig. #	Copper Stranded Range	Copper Solid Range	B	J Dia.	L	C	T	W
NAS292N	1	6 AWG-250 kcmil	6 AWG-4/0 AWG	2.38	3/8	5.62	1.50	0.25	2.00
NAS2934N	2			2.38	3/8	5.62	3.00	0.25	2.00
NAS29N	—			2.38	3/8	3.88	1.25	0.25	2.00
NAS342N	1	1/0 AWG-500 kcmil	1/0 AWG-4/0 AWG	2.38	3/8	5.62	2.00	0.31	2.20
NAS3434N	2			2.38	3/8	5.62	3.00	0.25	2.20
NAS34N	—			2.38	3/8	4.12	1.50	0.25	2.20
NAS40-2N	1	2/0 AWG-800 kcmil	2/0 AWG-4/0 AWG	2.62	3/8	5.88	2.00	0.38	2.44
NAS4034N	2			2.62	3/8	5.88	3.00	0.31	2.44

Bolted Terminals, Type NA
For Copper Tube to Pad

Material: Copper Alloy

Hardware: DURIIUM™ Silicon Bronze

High copper alloy terminal for joining copper tube to a flat pad. Letter "N" on end of catalog number indicates pad drilled to NEMA standards. One-wrench installation.

Notes :

- Plated versions: add the required suffix to the catalog number. -TN for regular tin plating.
- Please contact factory for other sizes, combinations and availability.

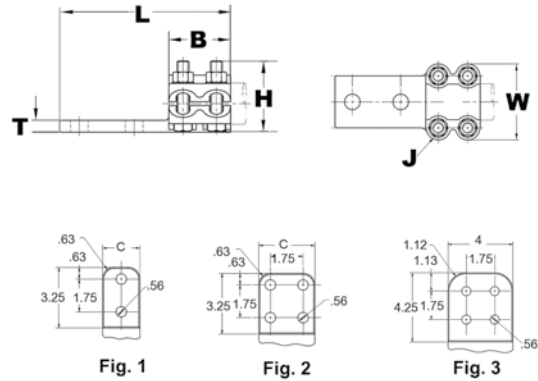
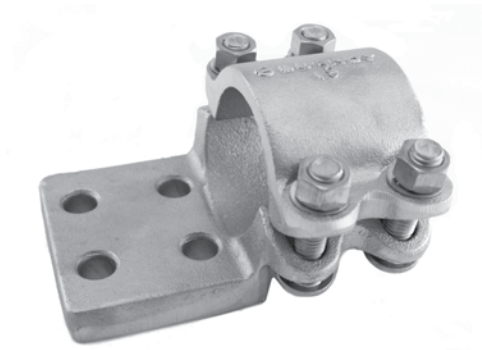

Catalog Number	Fig. #	Copper Pipe (Std or EH)	B	J Dia.	L	H	C	T	W		
NA122N	1	3/8 IPS	1.38	3/8	3.75	1.50	1.50	0.25	2.13		
NA132N	1	1/2 IPS	2.00		5.25	1.75	1.50	0.38	2.25		
NA142N	1	3/4 IPS			5.25	2.00	1.63	0.38	2.44		
NA144N	2				4.50	2.00	3.13	0.38	2.44		
NA152N	1	1 IPS			5.25	2.06	1.88	0.38	2.75		
NA154N	2				5.25	2.06	3.00	0.38	2.75		
NA164N	2	1 1/4 IPS		2.69	1/2	5.94	2.56	3.00	0.44	3.50	
NA172N	1	1 1/2 IPS	5.94			2.75	2.50	0.50	3.94		
NA174N	2		5.94			2.75	3.00	0.50	3.94		
NA1744NHQ	3		7.07			3.09	4.00	0.50	3.82		
NA184N	2	2 IPS	5.94			3.13	3.13	0.50	4.63		
NA1944N	3	2 1/2 IPS	7.19			3.74	4.00	0.69	5.24		
NA194N	2		5.94			3.69	3.75	0.69	5.25		
NA194N90CG2	2		2 1/2 IPS			6.50	3.62	3.75	0.69	5.25	
NA214N	2	3 1/2 IPS	3.25			5/8	6.56	4.94	4.75	0.81	6.81
NA224N	2	4 IPS					6.56	5.50	5.25	0.81	7.44

Bolted Terminals, Type NAH For Copper Cable to Pad

Material: Copper Alloy

Hardware: DURIU™ Silicon Bronze

Copper alloy terminal for joining a wide range of cable to equipment pads. Tongue side formed to provide adequate clearance and terminal is designed for one-wrench installation.

Notes :

- Plated versions: add the required suffix to the catalog number. -TN for regular tin plating.
- Please contact factory for other sizes, combinations and availability

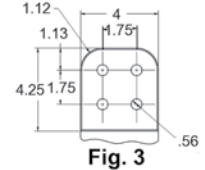
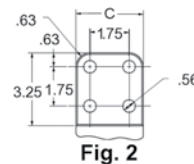
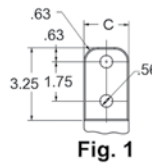
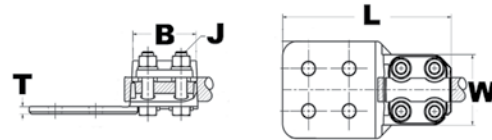
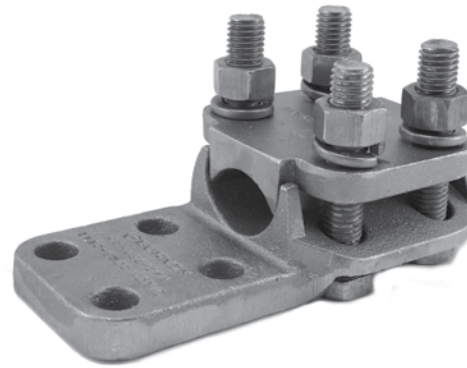

Catalog Number	Fig. #	Copper Stranded Range	Copper Solid Range	B	J Dia.	L	C	T	W						
NAH292N	1	6 AWG-250 kcmil	6 AWG-4/0 AWG	2.62	1/2	5.88	1.50	0.25	2.44						
NAH2934N	2						3.00								
NAH342N	1	1/0 -500 kcmil	1/0 AWG-4/0 AWG				2.00	0.31	2.56						
NAH3434N	2						3.00	0.25							
NAH402N	1	2/0 AWG-800 kcmil	3/0 AWG-4/0 AWG				2.88	1/2	6.88	2.00	0.38	2.81			
NAH4034N	2									3.00	0.31				
NAH4044N	3			4.00											
NAH442N	1	4/0 AWG-1000 kcmil	N/A	3.06	1/2	6.12				2.00	0.44	2.88			
NAH4434N	2									3.00	0.38				
NAH4444N	3									4.00	0.31				
NAH4634N	2	1000 kcmil-1500 kcmil	N/A				3.25	1/2	6.31	3.00	0.41	3.19			
NAH482N	1	500 kcmil-2000 kcmil	N/A							3.75	5/8		7.12	2.00	0.69
NAH4834N	2											3.00		0.50	3.38
NAH4844N	3			4.00	0.44										
NAH4862N	1	2000 kcmil-2500 kcmil	N/A	3.75	5/8	7.12						3.00		0.63	3.96
NAH48634N	2														

Bolted Terminals, Type N2AH
For Two Copper Cables to Pad

Material: Copper Alloy

Hardware: DURIIUM™ Silicon Bronze

High copper alloy reversible cap terminal for joining a wide range of cable to pads. Tongue is side formed to provide adequate clearance and terminal is designed for one wrench installation.

Notes :

- Plated versions: add the required suffix to the catalog number. -TN for regular tin plating.
- Please contact factory for other sizes, combinations and availability.

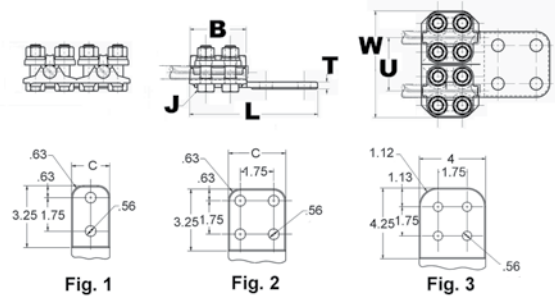

Catalog Number	Fig. #	Copper Stranded Range	Copper Solid Range	B	J Dia.	L	C	T	W	U
N2AH2934N	2	6 AWG-250 kcmil	6 AWG-4/0 AWG	2.62	1/2	5.87	3.00	0.32	4.88	2.44
N2AH342N	1	1/0 AWG-500 kcmil	1/0 AWG-4/0 AWG	2.62	1/2	5.87	2.00	0.32	5.44	2.88
N2AH3434N	2	1/0 AWG-500 kcmil	1/0 AWG-4/0 AWG	2.63	1/2	6.13	3.00	0.38	5.40	2.88
N2AH3444N	3	1/0 AWG-500 kcmil	1/0 AWG-4/0 AWG	2.63	1/2	7.00	4.00	0.38	5.38	2.88
N2AH4434N	2	4/0 AWG-1000 kcmil	4/0 AWG	2.88	1/2	6.38	3.00	0.50	6.12	3.12
N2AH4444N	3	4/0 AWG-1000 kcmil	4/0 AWG	2.88	1/2	7.32	4.00	0.50	6.12	3.12
N2AH4444NHQ	3	4/0 AWG-1000 kcmil	4/0 AWG	2.88	1/2	7.20	4.00	0.50	6.12	3.12
N2AH4644N	3	1000 kcmil-1500 kcmil	N/A	3.07	1/2	7.46	4.00	0.75	6.50	3.36
N2AH4844N	3	1000 kcmil-1500 kcmil	N/A	3.25	1/2	7.62	4.00	0.75	9.50	4.00

VARILUG™ Terminals, Type VVA For Copper Cable to Pad

Material: Bronze Alloy

Hardware: DURIU™ Silicon Bronze

High copper alloy terminal for joining a wide range of cable to equipment pads or bar. Particularly suitable for use on extra flexible cable. One-wrench installation.

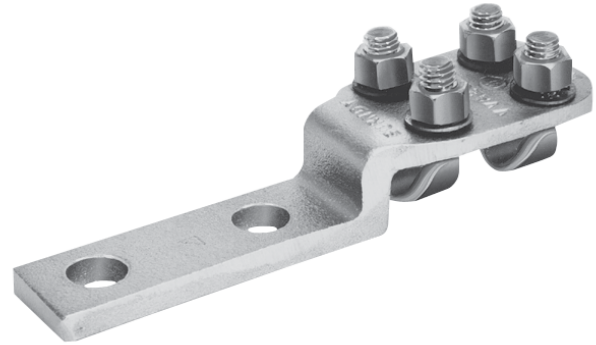

Notes :

- Plated versions: add the required suffix to the catalog number. -TN for regular tin plating
- Please contact factory for other sizes, combinations and availability

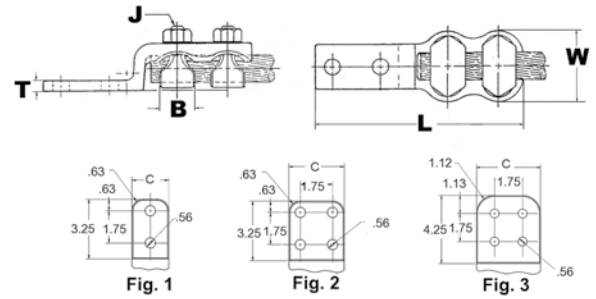

Catalog Number *	Fig. #	Copper Stranded Range	Copper Solid Range	C	B	J Dia.	L	T	W
VVA25	—	6 AWG-1/0	6 AWG-1/0 AWG	0.88	0.88	3/8	4.31	0.25	1.19
VVA28	—	1/0 AWG-4/0 AWG	1/0 AWG-4/0 AWG	1.06	1.09	3/8	4.13	0.31	1.69
VVA282N	1			1.06	1.09	3/8	6.19	0.31	1.69
VVA302N	1	300 kcmil	1/0 AWG-4/0 AWG	1.13	1.09	7/16	6.56	0.31	1.94
VVA34	—	300 kcmil-500 kcmil	N/A	1.38	1.31	1/2	5.31	0.38	2.25
VVA342N	1			1.30	1.31	1/2	6.88	0.38	2.22
VVA344N	2			3.13	1.31	7/16	7.00	0.38	2.38
VVA40	—	500 kcmil-800 kcmil		1.63	1.34	9/16	6.38	0.38	2.63
VVA402N	1			1.62	1.34	9/16	7.69	0.38	2.62
VVA404N	2			3.00	1.34	9/16	7.69	0.38	2.62
VVA404NCG1	—			3.50	0.88	9/16	7.69	0.38	2.62
VVA442N	1	750 kcmil-1000 kcmil		1.88	1.41	5/8	8.12	0.50	2.88
VVA444N	2			3.00	1.41	5/8	8.06	0.50	2.88
VVA462N	1	1000 kcmil-1500 kcmil		2.25	2.00	5/8	8.69	0.56	3.25
VVA464NCG2	—		3.50	2.00	5/8	8.75	0.56	3.25	
VVA464NCG4	—		3.50	2.00	5/8	5.50	0.56	3.23	

* "N" indicates NEMA standard stud holes.

VARILUG™ Terminals, Type VV2A
Two Copper Cables to Pad

Material: Copper Alloy

Hardware: DURIUM™ Silicon Bronze

Twin V elements to secure joint against vibration and flexing. Particularly recommended for use on extra flexible cables. One-wrench installation.



Notes :

- Plated versions: add the required suffix to the catalog number. -TN for regular tin plating
- Please contact factory for other sizes, combinations and availability

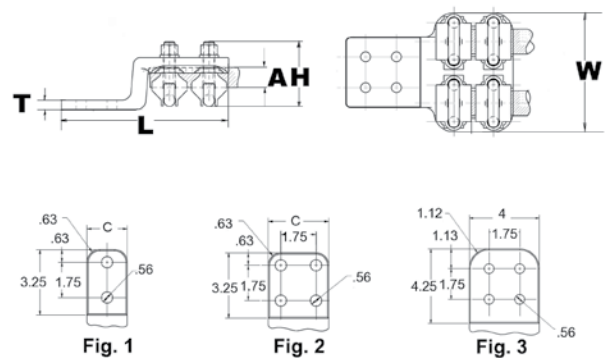

Catalog Number	Fig. #	Copper Stranded Range	L	C	T	W	H
VV2A34CG1	2	300 kcmil-500 kcmil	5.75	3.00	0.38	5.12	2.62
VV2A4044N	3	500 kcmil-800 kcmil	9.06	4.00	0.50	5.56	1.75
VV2A46CG1	2	1000 kcmil-1500 kcmil	8.75	3.50	0.56	6.75	4.00

VARILUG™ Terminal, Type VV3A

Three Copper Cables to Pad

Material: Copper Alloy

Hardware: DURIMUM™ Silicon Bronze

Type VV3A has three V elements to secure joint against vibration and flexing. Particularly recommended for use on extra flexible cables. One-wrench installation.



Notes :

- Plated versions: add the required suffix to the catalog number. -TN for regular tin plating
- Please contact factory for other sizes, combinations and availability
- Items with -90 and -45 have oriented pad, respectively 90° and 45°

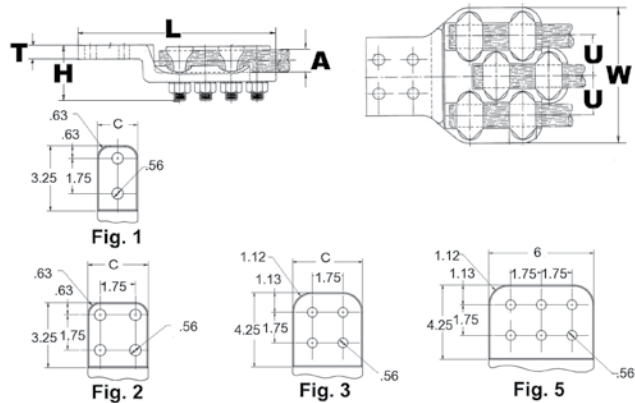

Catalog Number	Fig. #	Copper Stranded Range	T	Pad Angle	L	C	H	U	W
VV3A46CG1	2	1000 kcmil-1500 kcmil	0.84	—	8.75	3.50	3.79	3.52	10.25
VV3A46CG2	2		0.63	—	10.19	5.25	3.93	3.50	10.25
VV3A46CG3	2		1.28	90°	5.84	5.25	6.28	3.50	10.25

Aluminum Terminals, Type NAR
For Cable to Pad

Material: Aluminum Alloy

Hardware: Aluminum

Aluminum alloy bolted type terminal for joining aluminum cable to copper or aluminum pads. Drilling in pad conforms to NEMA Standards. PENETROX™ joint compound recommended on contact surfaces.



Notes :

- Properly proportioned to minimize conductor corrosion due to galvanic action. When properly used, this item does not require use of bimetallic plates; Please contact BURNDY Technical Support for recommendations
- PENETROX™ A joint compound is recommended on contact surfaces
- Please contact factory for other sizes, combinations, and availability
- One wrench installation

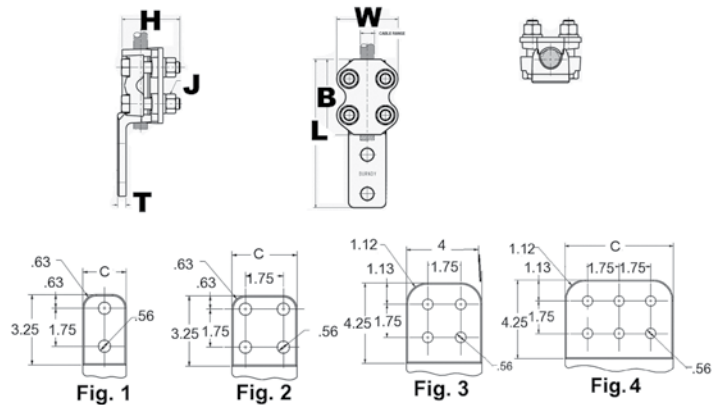

Catalog Number	Fig. #	Aluminum Stranded	Aluminum ACSR	B	J Dia.	L	H	C	T	W
NAR25A2N	1	4 AWG-1/0 AWG	4 (6/1) Swan AWG-1/0 (6/1) Raven AWG	2.00	1/2	5.10	2.72	1.25	0.31	2.28
NAR29A2N	1	1/0 AWG-250 kcmil	1/0 (6/1) Raven AWG-4/0 (6/1) Penguin AWG	2.75	1/2	6.06	2.75	1.38	0.31	2.50
NAR29A4N	2			2.88	1/2	6.06	2.75	3.00	0.31	3.00
NAR32A2N	1	250 kcmil-400 kcmil	4/0 (6/1) Penguin AWG-397.5 (30/7) Larkspur kcmil	3.00	1/2	6.31	2.88	1.63	0.38	2.63
NAR32A4N	2		4/0 (6/1) Penguin AWG-397.5 (30/7) Larkspur kcmil	3.00	1/2	6.31	2.88	3.00	0.38	3.00
NAR36A2N	1	350 kcmil-600 kcmil	336.4 (30/7) Oriole kcmil-477. (30/7) Hen kcmil	3.25	1/2	6.63	2.81	1.69	0.38	2.75
NAR36A4N	2		336.4 (30/7) Oriole kcmil-477. (30/7) Hen kcmil	3.25	1/2	6.63	2.81	3.00	0.38	3.00
NAR42A2N	1	600 kcmil-900 kcmil	477. (30/7) Hen kcmil-795 (30/19) Mallard kcmil	3.50	1/2	6.81	3.31	2.00	0.50	3.00
NAR42A4N	2			3.50	1/2	6.81	3.31	3.00	0.50	3.00
NAR45A2N	1	900 kcmil-1250 kcmil	715.5 (30/19) Redwing kcmil-1113 (54/19) Finch kcmil	2.63	1/2	7.12	3.31	2.63	0.50	3.20
NAR45A4N	2			3.75	1/2	7.12	3.31	3.00	0.50	3.20
NAR46A2N	1	1250 kcmil-1600 kcmil	1113 (54/19) Finch kcmil-1431 (54/19) Plover kcmil	4.38	5/8	7.69	3.69	2.75	0.56	3.75
NAR46A4N	2			4.38	5/8	7.69	3.69	3.00	0.56	3.75
NAR48A2N	1	1500 kcmil-2000 kcmil	1272 (54/19) Pheasant kcmil-1780 (54/19) kcmil	4.50	5/8	7.88	3.94	2.75	0.69	3.88
NAR48A4N	2			4.50	5/8	7.88	3.94	3.00	0.69	3.88

Substation - Bolted

Aluminum T Terminal, Tube to Centerline Tap Pad
Type NBC-A

Aluminum T Terminal, Type NBC-A For Tube to Centerline Tap Pad

Material: Aluminum Alloy

Hardware: Aluminum

Aluminum alloy bolted type terminal for joining aluminum tube to copper or aluminum pads. Drilling in pad conforms to NEMA Standards. PENETROX™ joint compound recommended on contact surfaces.

Notes :

- Properly proportioned to minimize conductor corrosion due to galvanic action. When properly used, this item does not require use of bimetallic plates; Please contact BURNDY Technical Support for recommendations
- PENETROX™ A joint compound is recommended on contact surfaces
- Please contact factory for other sizes, combinations, and availability
- One wrench installation

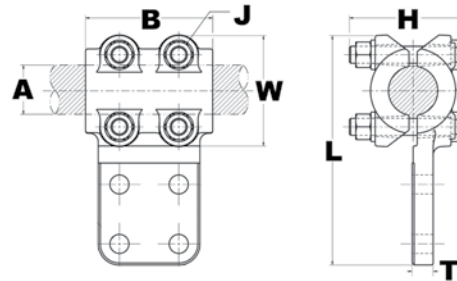

Catalog Number	Fig. #	Al tube	B	J Dia.	L	H	T
NBC15A2N	1	1 IPS	3.50	1/2	6.81	3.00	3/8
NBC16A2N	1	1 1/4 IPS	3.75	1/2	7.15	3.25	3/8
NBC16A34N	2		3.75	1/2	7.15	3.25	3/8
NBC16A44N	3		3.75	1/2	8.15	3.25	3/8
NBC17A2N	1	1 1/2 IPS	4.00	1/2	7.39	3.50	3/8
NBC17A34N	2		4.00	1/2	7.39	3.50	3/8
NBC17A44N	3		4.00	1/2	8.39	3.50	3/8
NBC18A2N	1	2 IPS	4.25	5/8	8.25	4.00	3/8
NBC18A34N	2		4.25	5/8	8.25	4.00	3/8
NBC18A44N	3		4.25	5/8	9.25	4.00	3/8
NBC19A34N	2	2 1/2 IPS	4.50	5/8	8.75	4.50	1/2
NBC19A44N	3		4.50	5/8	9.75	4.50	1/2
NBC20A34N	2	3 IPS	5.00	5/8	9.37	4.50	1/2
NBC20A44N	3		5.00	5/8	10.37	4.50	1/2
NBC21A44N	3	3 1/2 IPS	5.50	5/8	10.89	5.00	5/8
NBC22A44N	3	4 IPS	6.00	5/8	11.37	5.50	5/8

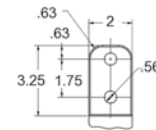

Fig. 1

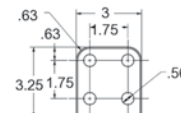

Fig. 2

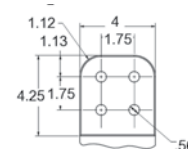

Fig. 3

Aluminum Terminals, Type NA-A For Tube to Pad

Material: Aluminum Alloy

Hardware: Aluminum

Aluminum alloy terminal for joining copper or aluminum tube to copper or aluminum pad.

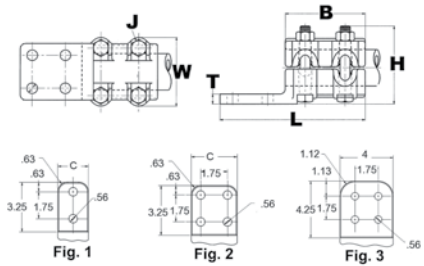

Notes :

- Properly proportioned to minimize conductor corrosion due to galvanic action. When properly used, this item does not require use of bimetallic plates; Please contact BURNDY Technical Support for recommendations
- PENETROX™ A joint compound is recommended on contact surfaces
- Please contact factory for other sizes, combinations, and availability
- One wrench installation

Catalog Number	Al tube	B	C	J Dia.	L	H	T	W
NA15A2N	1 IPS	3.50	1.88	1/2	6.75	3.38	0.38	3.06
NA15A4N		3.50	3.00	1/2	6.75	3.38	0.38	3.06
NA16A2N	1 1/4 IPS	3.75	2.25	1/2	7.00	3.38	0.44	3.40
NA17A2N	1 1/2 IPS	4.00	2.50	1/2	7.50	3.88	0.50	3.64
NA17A4N		4.00	3.00	1/2	7.50	3.88	0.50	3.64
NA18A2N	2 IPS	4.25	2.75	5/8	7.50	4.47	0.50	4.50
NA18A4N		4.25	3.12	5/8	7.50	4.47	0.50	4.50
NA19A4N	2 1/2 IPS	4.50	3.75	5/8	7.75	4.97	0.69	5.00
NA20A4N	3 IPS	5.00	4.38	5/8	8.31	5.47	0.69	5.62
NA22A4N	4 IPS	6.00	5.25	5/8	9.31	6.22	0.81	6.62

Type STS-A-NCG, Single Piece Terminal Pad Cap; EHV

Bolted 1-piece terminal pad cap of cast Aluminum; Stainless Steel Hardware.

Material: Aluminum Alloy

EHV Rated: Self Shielding at operating voltages up to 500 kV

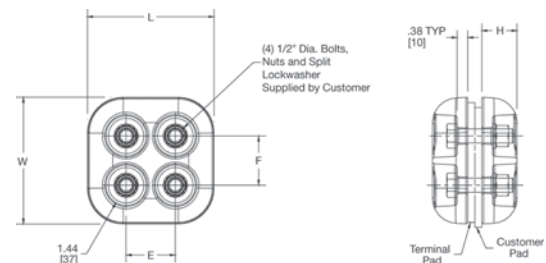

Catalog Number	E	F	H	L	W	Maximum Shielded Area
STS44ACG10	1.75 [44]	1.75 [44]	1.50 [38]	4.00 [102]	4.00 [102]	3.5 x 3.5
STS44A4NCG2	1.75 [44]	1.75 [44]	1.25 [32]	4.50 [114]	4.50 [114]	4 x 4
STS46A6NCG1	1.75 [44]	1.75 [44]	1.25 [32]	4.50 [114]	6.50 [165]	6 x 4

NOTES:

1. Dimensions in brackets [] are in millimeters.
2. Catalog number is for one shielding cap only. If more than one is required, specify total quantity.

Copper Bolted Couplers, Type NS For Copper Straight Tube to Tube

Material: Copper Alloy

Hardware: DURIMUM™ Silicon Bronze

High copper alloy coupler for joining equal sizes of tube end to end. Slots between bolts provide independent high pressure areas of contact. One-wrench installation.

Notes :

- Plated versions: add the required suffix to the catalog number. -TN for regular tin plating; -W for extra thick tin plating (including hardware)
- Items with -HC suffix have hex head bolts; items without the suffix can be either hex head or oval shank head; both head styles are one wrench installation and offer the same clamping force and functionalities
- Please contact factory for sizes, combinations and availability

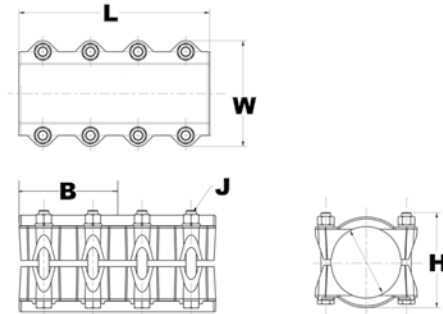

Catalog Number	Copper Conductor	B	J Dia.	L	H	W
NS1313	1/2 IPS	1.63	3/8	3.25	1.69	2.25
NS1414HC	3/4 IPS	2.69	3/8	5.38	2.32	2.81
NS1515	1 IPS	2.13	3/8	4.25	2.13	2.75
NS1515HC		2.69	1/2	5.62	2.32	3.25
NS1515HCHQ		2.69	1/2	5.63	2.36	3.22
NS1616HC	1 1/4 IPS	2.69	1/2	5.75	2.57	3.50
NS1717	1 1/2 IPS	2.88	1/2	5.75	2.75	3.94
NS1717HCHQ		2.69	1/2	5.75	2.61	3.94
NS1818	2 IPS	2.88	1/2	5.75	3.31	4.63
NS1919	2 1/2 IPS	2.88	1/2	5.75	3.88	5.25
NS1919HCHQ		2.69	1/2	5.75	3.56	5.18
NS2121HC	3 1/2 IPS	3.25	5/8	7.25	5.20	6.81

Aluminum Couplers, Type NS-A
For Aluminum Tube to Tube

Material: Aluminum Alloy

Hardware: Aluminum

Aluminum alloy coupler for joining equal sizes of tube end to end. Properly proportioned to permit use on aluminum-copper conductor combinations. One-wrench installation. PENETROX™ joint compound recommended on contact surfaces.

Notes :

- PENETROX™ A joint compound is recommended on contact surfaces
- Please contact factory for other sizes, combinations, and availability

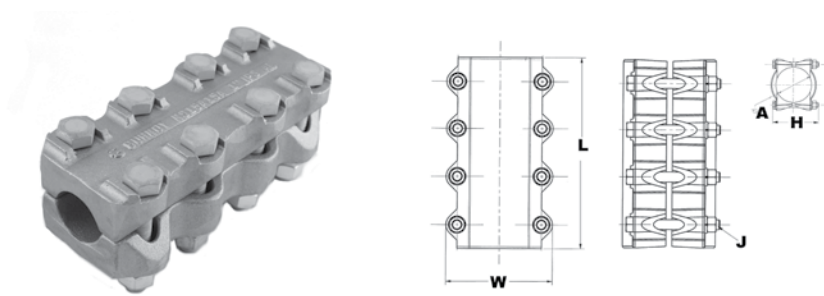

Catalog Number	A - tube	J Dia.	L	H	W
NS14A14A	3/4 IPS	1/2	6.75	2.06	2.80
NS15A15A	1 IPS		7.25	2.18	3.06
NS17A17A	1 1/2 IPS		8.25	4.00	3.64
NS18A18A	2 IPS	5/8	8.75	4.62	4.50
NS19A19A	2 1/2 IPS		9.31	4.26	5.00
NS21A21A	3 1/2 IPS		8.00	5.25	6.14
NS22A22A	4 IPS		12.00	5.94	6.62
NS86A86A	6 IPS		16.25	8.04	8.76

T-Connector, Type NT

For Copper Tube to Tube: T Application

Material: Copper Alloy

Hardware: DURIMUM™ Silicon Bronze

High copper alloy T-Connector for tubing run and tap. Slots between bolts provide independent high-pressure areas of contact. One-wrench installation.

Notes :

- Plated versions: add the required suffix to the catalog number. -TN for regular tin plating
- Items with -HC suffix have hex head bolts; items without the suffix can be either hex head or oval shank head. Both head styles are one wrench installation and offer the same clamping force and functionalities
- Please contact factory for other sizes, combinations and availability
- One-wrench installation.

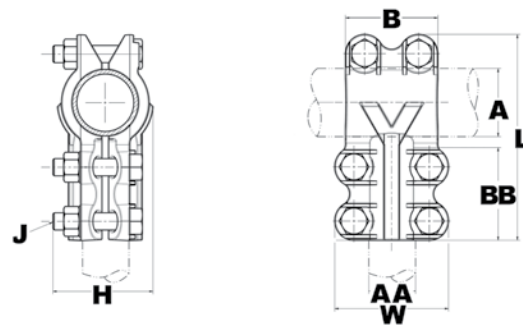

Catalog Number	A Run Copper Pipe	AA Tap Copper Pipe	B	J Dia.	BB	L	H	W
NT1313	1/2 IPS	1/2 IPS	2.00	3/8	2.00	4.13	1.94	2.44
NT1414	3/4 IPS	3/4 IPS			2.00	4.13	1.94	2.44
NT1514	1 IPS	3/4 IPS			2.00	4.38	2.13	2.44
NT1515		1 IPS			2.00	4.44	2.13	2.75
NT1614	1 1/4 IPS	3/4 IPS			2.00	4.75	2.44	2.44
NT1616		1 1/4 IPS	2.69	5.69	2.63	3.50		
NT1714	1 1/2 IPS	3/4 IPS	2.00	3/8	2.00	5.06	2.69	2.44
NT1717		1 1/2 IPS	2.69	6.06	2.75	3.94		
NT1817	2 IPS	1 1/2 IPS	2.69	1/2	2.69	6.63	3.25	3.94
NT1919	2 1/2 IPS	2 1/2 IPS	3.63	1/2	2.69	7.25	3.88	5.25
NT2020	3 IPS	3 IPS	4.31	5/8	3.25	8.63	4.63	6.19
NT2121	3 1/2 IPS	3 1/2 IPS	4.88		3.25	9.25	5.19	6.81
NT2222	4 IPS	4 IPS	5.44		3.25	9.81	5.75	7.44

T-Connector, Type NSNT

For Copper Tube or Cable to Cable: T Application

Material: Copper Alloy

Hardware: DURSIUM™ Silicon Bronze

High copper alloy reversible T-Connector for joining a wide range of run and tap cables. Connector is designed for one-wrench installation. "S" standard 3/8 in hardware and "H" heavy duty 1/2 in hardware.

Notes :

- Plated versions: add the required suffix to the catalog number. -TN for regular tin plating.
- Please contact factory for other sizes, combinations and availability.
- One-wrench installation.

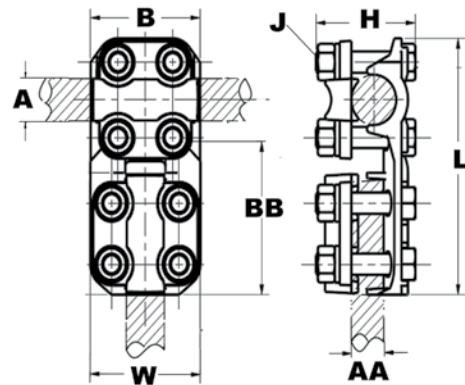
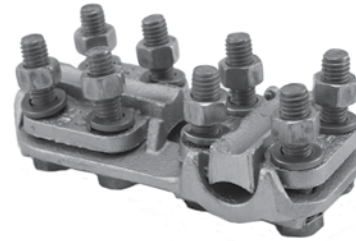

Catalog Number	A Pipe Run	A Cable Run	AA ① Cable Tap Range	B	J Dia.	BB	L	H	W
NSNT1329	1/2 IPS	N/A	6 AWG-250 kcmil	2.00	3/8	2.38	5.08	2.00	1.96
NSNT1429	3/4 IPS		6 AWG-250 kcmil	2.00	3/8	2.38	5.08	2.00	1.96
NSNT1434			1/0 AWG-500 kcmil	2.00	3/8	2.38	5.08	2.10	2.20
NSNT1529	1 IPS		6 AWG-250 kcmil	2.00	3/8	2.38	5.34	2.00	1.96
NSNT1629	1 1/4 IPS		6 AWG-250 kcmil	2.00	3/8	2.38	5.78	2.37	1.96
NSNT2929	—	6 AWG-250 kcmil	6 AWG-250 kcmil	2.38	3/8	2.38	4.60	1.75	1.96
NSNT3429		1/0 AWG-500 kcmil	6 AWG-250 kcmil	2.38	3/8	2.38	4.84	2.00	1.96
NSNT3434			1/0 AWG-500 kcmil	2.38	3/8	2.38	4.84	2.00	2.20

① Complete cable range may be accommodated by reversing cap.

Substation - Bolted

T-Connector Terminal; Copper Tube to Cable
Type NHNT

T-Connectors Terminals, Type NHNT For Copper Tube to Cable: T Application

Material: Copper Alloy

Hardware: DURIMUM™ Silicon Bronze

High copper alloy reversible T-Connector for joining a wide range of run pipe and tap cables. Connector is designed for one-wrench installation.

Notes :

- Plated versions: add the required suffix to the catalog number. -TN for regular tin plating
- Please contact factory for other sizes, combinations and availability
- One-wrench installation

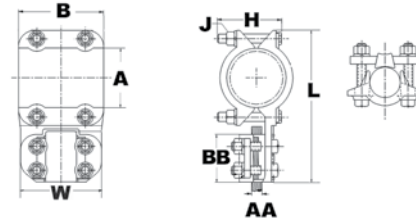

Catalog Number	A Pipe Run	AA ① Cable Tap Range	B	J Dia.	BB	L	H	W
NHNT1429	3/4 IPS	6 AWG-250 kcmil	2.25	1/2	2.62	5.82	2.32	2.44
NHNT1434		1/0 AWG-500 kcmil	2.25	1/2	2.62	5.82	2.42	2.56
NHNT1529	1 IPS	6 AWG-250 kcmil	2.25	1/2	2.62	5.92	2.57	2.44
NHNT1534		1/0 AWG-500 kcmil	2.25	1/2	2.62	5.92	2.57	2.56
NHNT1540		2/0 AWG-800 kcmil	2.25	1/2	2.62	5.92	2.60	2.78
NHNT1629	1 1/4 IPS	6 AWG-250 kcmil	2.69	1/2	2.62	6.32	2.57	2.44
NHNT1634		1/0 AWG-500 kcmil	2.69	1/2	2.62	6.32	2.60	2.56
NHNT1640		2/0 AWG-800 kcmil	2.69	1/2	2.62	6.32	2.68	2.78
NHNT1644		4/0 AWG-1000 kcmil	2.69	1/2	2.88	6.58	2.69	2.90
NHNT1729	1 1/2 IPS	6 AWG-250 kcmil	2.69	1/2	2.62	6.76	2.70	2.44
NHNT1734	1 1/2 IPS	1/0 AWG-500 kcmil	2.69	1/2	2.62	6.76	2.70	2.56
NHNT1740	1 1/2 IPS	2/0 AWG-800 kcmil	2.69	1/2	2.62	6.76	2.78	2.78
NHNT1744		4/0 AWG-1000 kcmil	2.69	1/2	2.88	7.02	2.80	2.90
NHNT1829	2 IPS	6 AWG-250 kcmil	2.69	1/2	2.62	7.44	3.06	2.44
NHNT1834		1/0 AWG-500 kcmil	2.69	1/2	2.62	7.44	3.06	2.56
NHNT1840		2/0 AWG-800 kcmil	2.69	1/2	2.62	7.44	3.06	2.78
NHNT1844		4/0 AWG-1000 kcmil	2.69	1/2	2.88	7.70	3.06	2.90
NHNT1846		1000 kcmil-1500 kcmil	2.69	1/2	3.06	7.88	3.23	3.16
NHNT1929	2 1/2 IPS	6 AWG-250 kcmil	2.69	1/2	2.62	8.06	3.64	2.44
NHNT1934		1/0 AWG-500 kcmil	2.69	1/2	2.62	8.06	3.64	2.56
NHNT1944		4/0 AWG-1000 kcmil	2.69	1/2	2.88	8.32	3.64	2.90
NHNT1946		1000 kcmil-1500 kcmil	2.69	1/2	3.06	8.50	3.64	3.16
NHNT2040	3 IPS	2/0 AWG-800 kcmil	2.69	1/2	2.88	8.69	4.26	2.78
NHNT2044		4/0 AWG-1000 kcmil	2.69	1/2	5.75	8.95	4.26	2.90
NHNT2229	4 IPS	6 AWG-250 kcmil	3.25	1/2	2.63	10.38	4.26	2.50

① Complete cable range may be accommodated by reversing cap.

T-Connector, Type VT

For Copper Cable to Cable: T Application

Material: Copper Alloy



Hardware: DURIIUM™ Silicon Bronze

High copper alloy T-connector for cable run, cable tap. V-bolt clamping elements accommodate large range of cable and are particularly suited for extra flexible cable. One-wrench installation.



Notes :

- Plated versions: add the required suffix to the catalog number. -TN for regular tin plating
- Please contact factory for other sizes, combinations and availability
- One-wrench installation

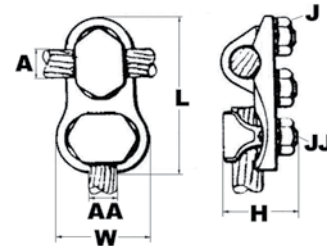

Catalog Number	A - Cable Run Range	AA - Cable Tap Range	J Dia.	JJ Dia.	L	H	W
VT2C2C	8 AWG-2 AWG	8 AWG-2 AWG	5/8	5/8	2.31	1.38	1.00
VT2525	6 AWG-1/0 AWG	6 AWG-1/0 AWG	3/4	3/4	1.37	0.38	0.56
VT2825	1/0 -4/0 AWG	6 AWG-1/0 AWG	3/8	3/4	3.12	1.62	1.25
VT2828	1/0 -4/0 AWG	1/0 -4/0 AWG	3/8	3/8	2.94	0.38	0.31
VT4434	750 kcmil-1000 kcmil	300 kcmil-500 kcmil	5/8	1/2	4.38	3.34	2.25

Aluminum T-Connectors, Type NNT For Aluminum and Copper Tube to Tube

Material: Aluminum Alloy

Hardware: Aluminum

Aluminum alloy T-Connector for tubing run and tap. Properly proportioned to permit use on copper-aluminum conductor combinations. Captured hex head bolts permit one-wrench installation. PENETROX™ joint compound recommended on contact surfaces.



Notes :

- PENETROX™ A joint compound is recommended on contact surfaces
- Please contact factory for other sizes, combinations and availability
- One-wrench installation

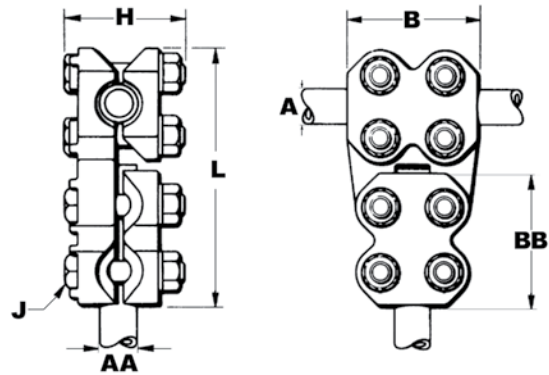

Catalog Number	A - Run tube	AA - Tap tube	B	J Dia.	BB	L	H
NNT15A15A	1 IPS	1 IPS	3.50	1/2	3.50	6.81	3.38
NNT16A16A	1 1/4 IPS	1 1/4 IPS	3.75	1/2	3.75	7.44	3.38
NNT17A17A	1 1/2 IPS	1 1/2 IPS	4.00	1/2	4.00	7.88	3.88
NNT18A18A	2 IPS	2 IPS	4.25	5/8	4.25	9.06	4.44
NNT20A20A	3 IPS	3 IPS	5.00	5/8	5.00	10.94	5.44
NNT21A20A	3 1/2 IPS	3 IPS	5.50	5/8	5.00	11.06	5.56
NNT22A22A	4 IPS	4 IPS	6.00	5/8	6.00	12.63	6.19

Aluminum T-Connectors, Type NNTR
For Cable to Cable

Material: Aluminum Alloy

Hardware: Aluminum

Aluminum alloy T-Connector for a range of cable run to range of cable tap. One-wrench installation.

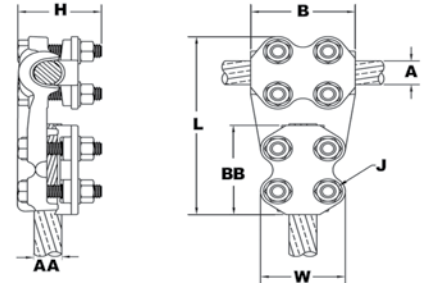

Notes :

- PENETROX™ A joint compound is recommended on contact surfaces
- Please contact factory for other sizes, combinations, and availability
- One-wrench installation

Catalog Number	A - Run Al Cable	A - Run ACSR Cable	AA - Tap Al Cable	AA - Tap ACSR Cable	B	J Dia.	BB	L	H	W
NNTR29A29A	1/0 AWG-250 kcmil	1/0 (6/1) Raven AWG-4/0 (6/1) Penguin AWG	1/0 AWG-250 kcmil	1/0 (6/1) Raven AWG-4/0 (6/1) Penguin AWG	2.75	1/2	2.75	5.56	2.56	2.50
NNTR32A32A	250 kcmil-400 kcmil	4/0 (6/1) Penguin AWG-397.5 (18/1) Chickadee kcmil	250 kcmil-400 kcmil	4/0 (6/1) Penguin AWG-397.5 (18/1) Chickadee kcmil	3.00	1/2	3.00	5.94	2.56	2.63
NNTR36A29A	350 kcmil-600 kcmil	336.4 (18/1) Merlin kcmil-477.0 (18/1) Pelican kcmil	1/0 AWG-250 kcmil	1/0 (6/1) Raven AWG-4/0 (6/1) Penguin AWG	3.25	1/2	2.75	5.31	2.56	2.50
NNTR36A36A	350 kcmil-600 kcmil	336.4 (18/1) Merlin kcmil-477.0 (18/1) Pelican kcmil	350 kcmil-600 kcmil	336.4 (18/1) Merlin kcmil-477.0 (18/1) Pelican kcmil	3.25	1/2	3.25	6.31	2.56	2.75
NNTR42A32A	600 kcmil-900 kcmil	477.0 (18/1) Pelican kcmil-795 (54/7) Condor kcmil	250 kcmil-400 kcmil	4/0 (6/1) Penguin AWG-397.5 (18/1) Chickadee kcmil	3.50	1/2	3.00	6.38	3.13	2.63
NNTR42A36A	600 kcmil-900 kcmil	477.0 (18/1) Pelican kcmil-795 (54/7) Condor kcmil	350 kcmil-600 kcmil	336.4 (18/1) Merlin kcmil-477.0 (18/1) Pelican kcmil	3.50	1/2	3.25	6.63	3.13	2.75
NNTR42A42A	600 kcmil-900 kcmil	477.0 (18/1) Pelican kcmil-795 (54/7) Condor kcmil	600 kcmil-900 kcmil	477.0 (18/1) Pelican kcmil-795 (54/7) Condor kcmil	3.50	1/2	3.50	6.88	3.13	3.00
NNTR45A45A	900 kcmil-1250 kcmil	715.5 (54/7) Crow kcmil-1113 (54/19) Finch kcmil	900 kcmil-1250 kcmil	715.5 (54/7) Crow kcmil-1113 (54/19) Finch kcmil	3.75	1/2	3.75	7.31	3.25	3.19
NNTR46A42A	1250 kcmil-1600 kcmil	1113 (54/19) Finch kcmil-1431 (54/19) Plover kcmil	600 kcmil-900 kcmil	477.0 (18/1) Pelican kcmil-795 (54/7) Condor kcmil	3.75	1/2	3.50	7.25	3.44	3.00
NNTR46A46A	1250 kcmil-1600 kcmil	1113 (54/19) Finch kcmil-1431 (54/19) Plover kcmil	1250 kcmil-1600 kcmil	1113 (54/19) Finch kcmil-1431 (54/19) Plover kcmil	4.38	5/8	4.38	8.31	3.69	3.75
NNTR48A48A	1500 kcmil-2000 kcmil	1272 (54/19) Pheasant kcmil-1780 (54/19) kcmil	1500 kcmil-2000 kcmil	1272 (54/19) Pheasant kcmil-1780 (54/19) kcmil	4.50	5/8	4.50	8.63	3.81	3.88

Aluminum T-Connectors, Type NNTR

For Tube to Cable

Material: Aluminum Alloy

Hardware: Aluminum

Aluminum alloy T-Connector for tube run, range of cable tap. Properly proportioned to permit use on copper-aluminum combinations. One-wrench installation. PENETROX™ joint compound recommended on contact surfaces.

Notes :

- PENETROX™ A joint compound is recommended on contact surfaces
- Please contact factory for other sizes, combinations, and availability
- One-wrench installation

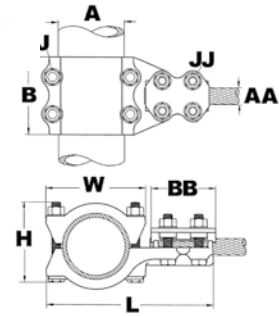

Catalog Number	A - Run Al Pipe	AA - Tap Al Cable	AA - Tap ACSR Cable	B	J Dia.	BB	L	H	JJ Dia.	W
NNTR15A36A	1 IPS	350 kcmil-600 kcmil	336.4 (18/1) Merlin kcmil-477.0 (18/1) Pelican kcmil	3.50	1/2	3.25	6.56	3.31	0.50	2.75
NNTR15A42A	1 IPS	600 kcmil-900 kcmil	477.0 (18/1) Pelican kcmil-795 (54/7) Condor kcmil	3.50	1/2	3.50	6.81	3.31	0.50	3.00
NNTR16A29A	1 1/4 IPS	1/0 AWG-250 kcmil	1/0 (6/1) Raven AWG-4/0 (6/1) Penguin AWG	3.75	1/2	2.75	6.44	3.31	0.50	2.50
NNTR16A32A	1 1/4 IPS	250 kcmil-400 kcmil	4/0 (6/1) Penguin AWG-397.5 (18/1) Chickadee kcmil	3.75	1/2	3.12	6.69	3.31	0.50	2.63
NNTR16A42A	1 1/4 IPS	600 kcmil-900 kcmil	477.0 (18/1) Pelican kcmil-795 (54/7) Condor kcmil	3.75	1/2	3.50	7.19	3.31	0.50	3.00
NNTR17A29A	1 1/2 IPS	1/0 AWG-250 kcmil	1/0 (6/1) Raven AWG-4/0 (6/1) Penguin AWG	4.00	1/2	2.75	6.69	3.81	0.50	2.50
NNTR18A29A	2 IPS			4.00	1/2	2.75	7.56	4.44	0.50	2.50
NNTR19A42A	2 1/2 IPS	600 kcmil-900 kcmil	477.0 (18/1) Pelican kcmil-795 (54/7) Condor kcmil	4.00	5/8	3.50	8.88	5.00	0.63	3.00
NNTR20A32A	3 IPS	250 kcmil-400 kcmil	4/0 (6/1) Penguin AWG-397.5 (18/1) Chickadee kcmil	4.00	1/2	3.00	9.00	5.44	0.50	2.63
NNTR22A46A	4 IPS	1250 kcmil-1600 kcmil	1113 (54/19) Finch kcmil-1431 (54/19) Plover kcmil	6.00	5/8	4.38	11.25	6.19	0.63	3.75

Copper Bus Supports, Type UH
 For Supporting Copper Tube to Base

Material: Copper Alloy

Hardware: DURIUUM™ Silicon Bronze

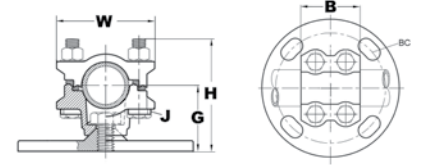

High copper alloy bus support for mounting tube on a post or pedestal type insulator. Single bolt allows rotation to any angle. Rotate cap 180° for slip or rigid fit. One wrench installation. Supplied with hardware for mounting to cap of insulator. Specify base mounting hardware, if required, by adding suffix "B" to catalog number.

Notes :

- One wrench installation
- Specify base mounting hardware, if required, by adding suffix "-B" to catalog number
- For other sizes and availability, please contact factory

Catalog Number	Copper Pipe Size	BC	G	J Dia.	B	H	W
UH143	3/4 IPS	3	2.00	3/8	2.50	2.88	2.63
UH153	1 IPS	3	2.00		2.50	3.00	2.88
UH163	1 1/4 IPS	3	2.25	1/2	2.69	3.44	3.50
UH165		5	2.38		2.69	3.56	3.50
UH173	1 1/2 IPS	3	2.50		3.00	3.81	3.81
UH175		5	2.50		3.00	3.81	3.81
UH183	2 IPS	3	2.75		3.00	4.31	4.63
UH193	2 1/2 IPS	3	3.13		3.00	5.00	5.25
UH195		5	3.13		3.00	5.00	5.25
UH205	3 IPS	5	3.63		5/8	3.25	5.81
UH225	4 IPS	5	4.50	3.25		7.25	7.50

Copper Bus Supports, Type UHR
 For Supporting Copper Cable or Tube to Base

Material: Copper Alloy

Hardware: DURIUUM™ Silicon Bronze

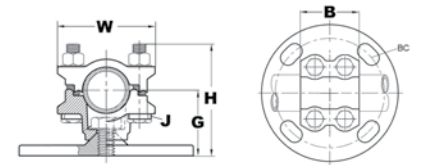

High copper alloy bus support clamp for mounting a wide range of cable or tube on post or pedestal type insulators. Single bolt allows rotation to any angle. Supplied with hardware for mounting to cap of insulator. Specify base mounting hardware, if required, by adding suffix "B" to catalog number.

Notes :

- One wrench installation
- Specify base mounting hardware, if required, by adding suffix "-B" to catalog number
- For other sizes and availability, please contact factory

Catalog Number	Copper Stranded Range	Copper Pipe Size	BC	G	J Dia.	B	H	W
UHR133	6 AWG - 500 kcmil	1/8 IPS -	3	1.75	3/8	3.63	3.00	2.25
UHR135		1/2 IPS	5	2.13	3/8	3.63	3.38	2.25
UHR153	4/0 AWG - 1250 kcmil	1/4 IPS - 1 IPS	3	2.00	3/8	3.75	3.50	2.75
UHR175	750 kcmil - 2500 kcmil	3/4 IPS - 1 1/2 IPS	5	2.50	1/2	2.88	4.25	3.94

* With maximum conductor in place.

Bus Supports, Type LH

For Supporting Copper Cable or Tube to Base

Material: Copper Alloy

Hardware: DURIMUM™ Silicon Bronze

High copper alloy, light duty bus support for mounting a wide range of cable or tube on post or pedestal type insulators. One-wrench installation. Supplied with hardware for mounting to cap of insulator. Specify base mounting hardware, if required, by adding suffix "-B" to Catalog No.

Notes :

- One wrench installation
- Specify base mounting hardware, if required, by adding suffix "-B" to catalog number
- For applications requiring heavier duty product, please see our UH product line
- For other sizes and availability, please contact factory.

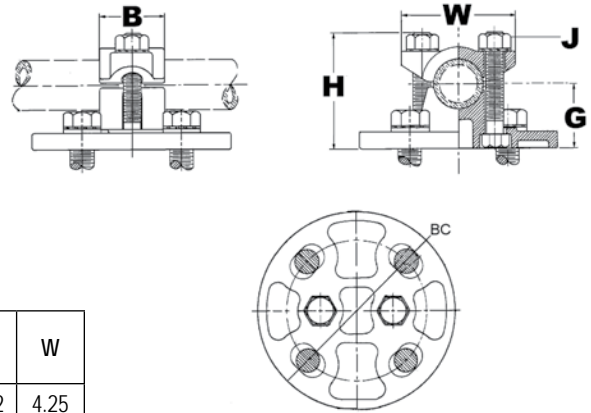

Catalog Number	Tube	Stranded Conductor	BC	G	J Dia.	B	H	W
LH283	N/A	6 AWG-4/0 AWG	3	1.25	3/8	1.69	2.62	4.25
LH343	1/4 IPS -1/2 IPS	2/0 AWG-500 kcmil	3	1.38	3/8	1.38	2.50	4.25
LH453	1/2 IPS-1 IPS	500 kcmil-1250 kcmil	3	1.50	1/2	1.62	3.19	4.44

Aluminum Bus Support, Type UHG
For Fixed or Rigid Pipe to Base

Material: Aluminum Alloy

Hardware: Aluminum

Aluminum alloy bus support for mounting tube on post or pedestal insulators. Properly proportioned to minimize conductor corrosion due to galvanic action. Caps are reversible for FIX or RIGID fit. One-wrench installation. Supplied with hardware for mounting to cap of insulator.

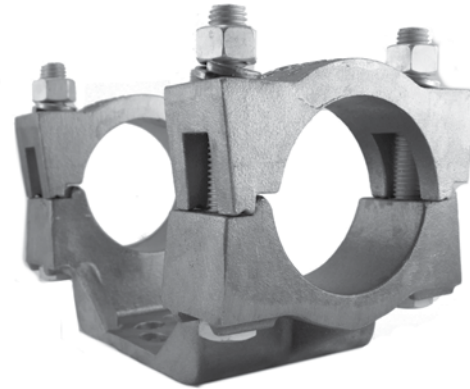

Notes :

- PENETROX™ A joint compound is recommended on contact surfaces
- Specify base mounting hardware, if required, by adding suffix "-B" to catalog number; items with suffix "-CH" include static clips

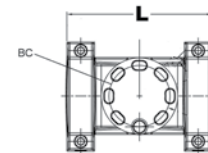
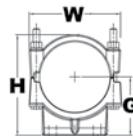
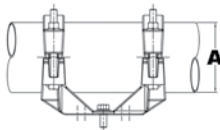

Catalog Number	A	BC	G	L	H	W	
UHG14A3	3/4 IPS	3.00	2.00	7.44	3.50	2.94	
UHG14A3CH	3/4 IPS			7.44	3.50	2.94	
UHG15A3	1 IPS			7.44	3.88	3.06	
UHG15A3CH	1 IPS			7.44	3.88	3.19	
UHG15A5CH	1 IPS	5.00	2.25	9.82	3.82	3.19	
UHG16A3CH	1 1/4 IPS	3.00		7.68	3.79	3.50	
UHG17A3	1 1/2 IPS	3.00	2.50	7.68	4.06	3.66	
UHG17A3CH	1 1/2 IPS			7.68	4.06	3.66	
UHG17A5	1 1/2 IPS	5.00		10.06	4.06	3.66	
UHG17A5CH	1 1/2 IPS			10.06	4.06	3.66	
UHG18A3	2 IPS	3.00	2.75	7.68	5.25	4.12	
UHG18A3CH	2 IPS			7.68	5.25	4.12	
UHG18A5	2 IPS	5.00		10.06	4.61	4.12	
UHG18A5CH	2 IPS			10.06	4.61	4.12	
UHG19A3	2 1/2 IPS	3.00	3.12	7.68	5.23	4.62	
UHG20A3CH	3 IPS	3.00	3.62	9.25	6.09	5.62	
UHG20A5	3 IPS			5.00	10.56	6.09	5.62
UHG20A5CH	3 IPS				10.56	6.09	5.62
UHG21A3	3 1/2 IPS			3.00	4.00	8.18	6.74

Catalog Number	A	BC	G	L	H	W
UHG22A3CH	4 IPS	3.00	4.50	8.18	7.50	6.62
UHG22A5	4 IPS	5.00		11.34	7.50	6.62
UHG22A5CH	4 IPS			11.34	7.50	6.62
UHG24A3	5 IPS	3.00	5.25	8.68	8.86	7.70
UHG24A3CH	5 IPS			8.68	8.86	7.70
UHG24A5	5 IPS	5.00		11.56	8.86	7.70
UHG24A5CH	5 IPS			11.56	8.86	7.70
UHG83A5	8 IPS	5.00	7.16	11.56	11.84	10.12
UHG86A5CH	6 IPS		5.56	11.56	9.94	8.75

Substation - Bolted

Aluminum Bus Support, Cable or Tube to Base
Type UHKR-A

Aluminum Bus Support, Type UHKR-A For Cable or Tube to Base

Material: Aluminum Alloy

Hardware: Aluminum

Aluminum alloy bus support for mounting a wide range of cable or tube on post or pedestal type insulators. Supplied with hardware for mounting to cap of insulator.

Notes :

- PENETROX™ A joint compound is recommended on contact surfaces
- Specify base mounting hardware, if required, by adding suffix “-B” to catalog number
- Please contact factory for other sizes, combinations, and availability

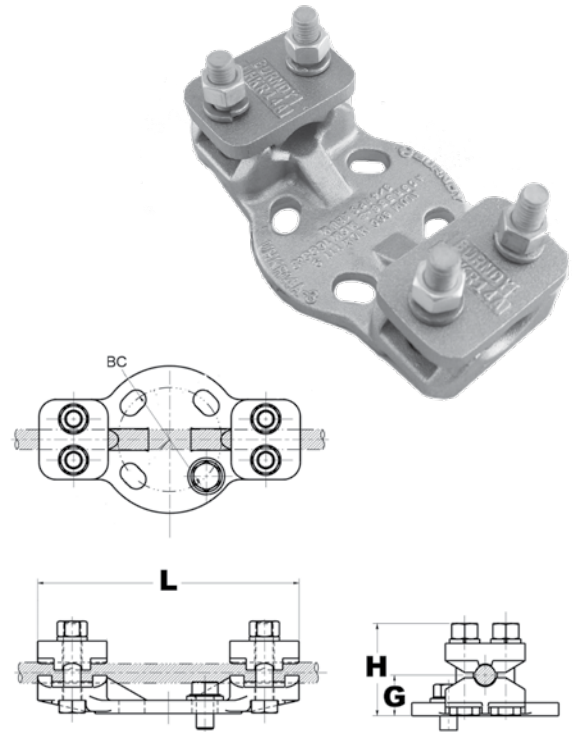

Catalog Number	Tube Size	Al Cable	ACSR Cable	BC	G*	L	H
UHKR11A3	1/4 IPS	4 AWG-4/0 AWG	6 (6/1) Turkey AWG-4/0 (6/1) Penguin AWG	3.00	1.16	7.56	2.63
UHKR11A5	1/4 IPS			5.00	1.16	8.50	2.63
UHKR13A3	3/8 IPS -1/2 IPS	250 kcmil-550 kcmil	266.8 (26/7) Owl kcmil-477. (30/7) Hen kcmil	3.00	1.32	7.56	3.88
UHKR13A5	3/8 IPS -1/2 IPS			5.00	1.32	8.88	2.88
UHKR14A3	3/4 IPS	600 kcmil-1113 kcmil	556.5 (26/7) Dove kcmil-1033.5 (54/7) Curlew kcmil	3.00	1.72	7.56	3.56
UHKR14A5	3/4 IPS			5.00	1.53	9.06	3.38
UHKR16A3	1 IPS -1 1/4 IPS	1000 kcmil-2000 kcmil	1113 (54/19) Finch kcmil-1780 (84/19) Chukar kcmil	3.00	1.97	7.56	4.06
UHKR16A5	1 IPS -1 1/4 IPS			5.00	1.80	9.25	3.88
UHKR17A5	1 1/4 IPS -1 1/2 IPS	2000 kcmil-2500 kcmil	1780 (84/19) Chukar kcmil-2156 (84/19) Bluebird kcmil	5.00	2.50	9.31	4.62

* With maximum conductor in place.

Aluminum End Cap, Type LB-A
For Use on Tube End Cap

Material: Aluminum Alloy

Hardware: Aluminum

Aluminum alloy end cap for aluminum tube. Driven into place for a secure fit. Seals out moisture, reduces electrostatic loss and eliminates hazards created by nesting birds.

Notes :

- Installation instructions available upon request
- Please contact factory for other sizes, combinations, and availability

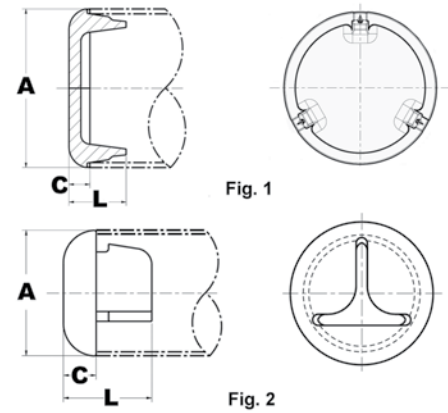
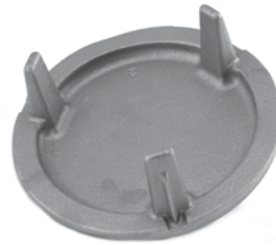

Catalog Number	Al tube Sch 40	Al tube Sch 80	C	L
LB16A	1 1/4 IPS	N/A	0.50	1.35
LB18A	2 IPS			2.16
LB19A	2 1/2 IPS		0.88	2.24
LB20A	3 IPS			2.29
LB21A	3 1/2 IPS			2.33
LB22A	4 IPS			2.22
LB23A	4 1/2 IPS			2.28
LB24A	5 IPS			2.45
LB83A	8 OD		0.75	2.28
LB86A	6 IPS		0.88	2.57
LB88A	8 IPS		0.75	2.28
LB55A	N/A		1 IPS	0.50
LB58A	N/A	2 IPS	0.88	2.16
LB91A	N/A	3 1/2 IPS	0.88	2.33
LB92A	N/A	4 IPS		2.22
LB94A	N/A	5 IPS		2.45
LB96A	N/A	6 IPS		2.57

Substation - Bolted

Copper Stud Connector, Copper Stud to Cable, Tube, Flat Bar
Type NDR

Copper Stud Connectors, Type NDR For Copper Stud to Cable, Tube, Flat Bar

Material: Copper Alloy

Hardware: DURIUUM™ Silicon Bronze

High copper alloy reversible and rotatable cap stud connector joins cable, tube and flat bar in-line or at right angles to equipment studs. Accommodates a wide range of cables or tubes. One-wrench installation.

Notes :

- Plated versions: add the required suffix to the catalog number. -TN for regular tin plating
- Please contact factory for other sizes, combinations and availability
- One-wrench installation

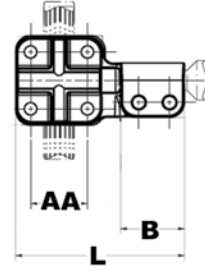

Catalog Number	Stud A	J Dia.	Threads per inch	B	AA Stranded Cable	JJ Dia.	L	H
NDR6434T16	3/4	3/8	16	1.53	6 AWG-500 kcmil	3/8	4.09	2.24
NDR6428T16			16	1.53	6 AWG-4/0 AWG	3/8	3.60	1.74
NDR6534T12	1		12	1.53	6 AWG - 500 kcmil	3/8	3.96	2.24
NDR6534T14			14	1.53		3/8	3.96	
NDR6544T14	1-1/8		14	1.53	2 AWG-1000 kcmil	1/2	4.73	2.82
NDR65534T12			12	1.53	6 AWG-500 kcmil	3/8	3.97	2.24
NDR65528T12			12	1.53	6 AWG-4/0 AWG	3/8	4.12	1.75
NDR65544T12	1-1/2		1/2	12	1.53	2 AWG-1000 kcmil	1/2	4.66
NDR6748T12		12		2.03	4/0 AWG-2000 kcmil	1/2	5.78	3.25
NDR67548T12	1-3/4	12		2.03		1/2	6.56	2.51
NDR67544T12		12		2.03	2 AWG-1000 kcmil	1/2	6.28	3.12
NDR6848T12	2	12	2.03	4/0 AWG-2000 kcmil	1/2	6.56	2.82	
NDR6844T12		12	2.03	2 AWG-1000 kcmil	1/2	6.12	2.88	

Stud Connectors, Type FD
For Copper Stud to Pad

Material: Copper Alloy

Hardware: DURIIUM™ Silicon Bronze

High copper alloy stud connector allows bolting cable and tubing terminals to equipment studs. Hex head captured bolts provide one-wrench installation. One pad contact surface is on centerline of stud. Pad is finished on both sides. All pads are four hole NEMA drilled.

Notes :

- Plated versions: add the required suffix to the catalog number.
-TN for regular tin plating
- Pad is finished on both sides
- Amperage rating given is for indoor conditions
- Please contact factory for other sizes, combinations and availability
- One-wrench installation

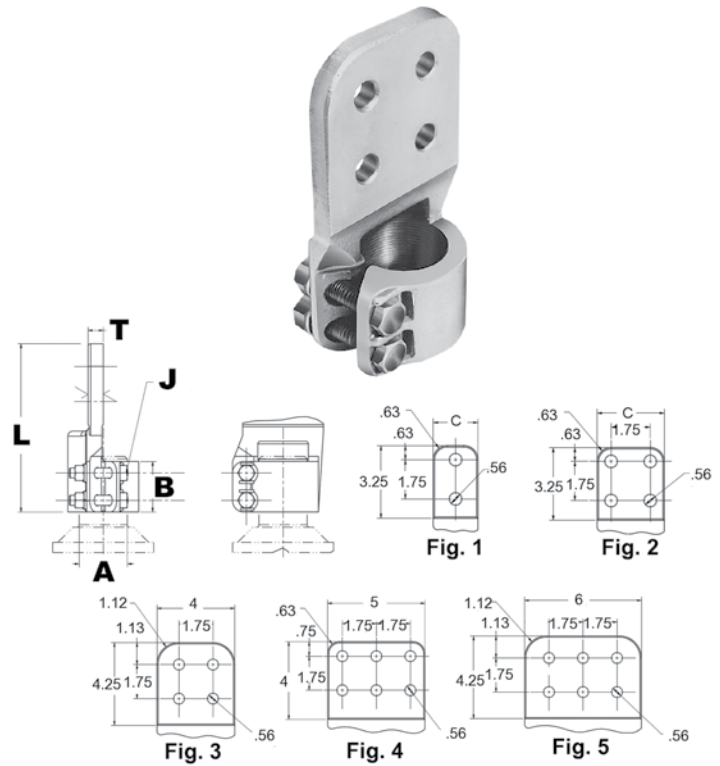

Catalog Number	Fig. #	Stud A	Threads per inch	Nominal Ampere Rating	B	J Dia.	L	T
FD64C5T16	2	3/4	16	1000	1.75	3/8	5.72	5/16
FD65C6T14	2	1	14	1075	1.75	3/8	5.72	3/8
FD655C6	2	1-1/8	12	1075	1.75	3/8	5.80	3/8
FD655D6	3		12	1300	1.75	3/8	6.86	3/8
FD66C6	2	1-1/4	12	1075	1.75	3/8	5.78	3/8
FD66D6	3		12	1300	1.75	3/8	6.84	3/8
FD675C8	2	1-3/4	12	1100	2.18	1/2	6.32	1/2
FD675D8	3		12	1450	2.18	1/2	7.39	1/2
FD68C8	2	2	12	1100	2.18	1/2	6.35	1/2
FD68D8	3		12	1450	2.18	1/2	7.42	1/2
FD68D12	3		12	2100	2.18	1/2	7.42	3/4
FD685C8	2	2-1/4	12	1100	2.50	1/2	6.71	1/2
FD685D12	3		12	2100	2.50	1/2	7.77	3/4
FD69C8	2	2-1/2	12	1100	2.50	1/2	6.77	1/2
FD69D8	3		12	1450	2.50	1/2	8.03	1/2
FD69D12	3		12	2100	2.50	1/2	8.03	3/4
FD70D12	3	3	12	2100	2.88	5/8	8.26	3/4
FD70D16	3		12	3000	2.88	5/8	8.24	1

Substation - Bolted

Stud Connector, Stud to 3 Cables - Flag
Type VV3D-R

Copper Stud Connectors, Type VV3D-R For Copper Stud to Three Cables - Flag

Material: Copper Alloy

Hardware: DURIMUM™ Silicon Bronze

High copper alloy stud connector allows bolting (3) cables to equipment studs. The cables have a flag position to equipment stud axis.

Notes :

- Plated versions: add the required suffix to the catalog number. -TN for regular tin plating
- Please contact factory for other sizes, combinations and availability
- One-wrench installation.
- V-bolt clamping element is particularly appropriate for flexible cables

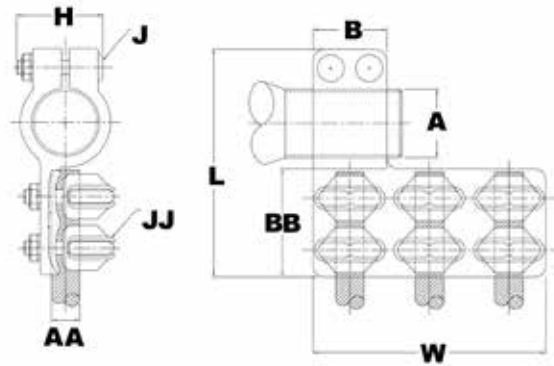

Catalog Number	Stud A	AA Stranded Cable	B	BB	J Dia.	JJ Dia.	L	H	W
VV3D6846R12	2	1000 kcmil-1500 kcmil	4.50	3.25	5/8	5/8	8.38	3.81	10.2
VV3D7046R12	3	1000 kcmil-1500 kcmil	4.50		5/8	5/8	10.0	3.81	10.2
VV3D7246R12	4	1000 kcmil-1500 kcmil	4.50		5/8	5/8	10.5	3.81	10.2

Aluminum Stud Connectors, Type SFD
For Stud to Pad

Material: Aluminum Alloy

Hardware: Aluminum
(modified by hardware suffixes)



Aluminum alloy stud connector for equipment bushing to conductor terminals. One wrench installation. Unless otherwise mentioned at the item level, this design embeds principles for self-shielding up to 550kV.

Notes :

- Properly proportioned to minimize conductor corrosion due to galvanic action. When properly used, this item does not require use of bimetallic plates. Please ask BURNDY® Technical Support for recommendations
- PENETROX™ A joint compound is recommended on contact surfaces
- Please contact factory for other sizes, combinations and availability
- Use shielding caps for high voltage applications (STS family). Shielding caps may be purchased separately
- Pad is finished on both sides

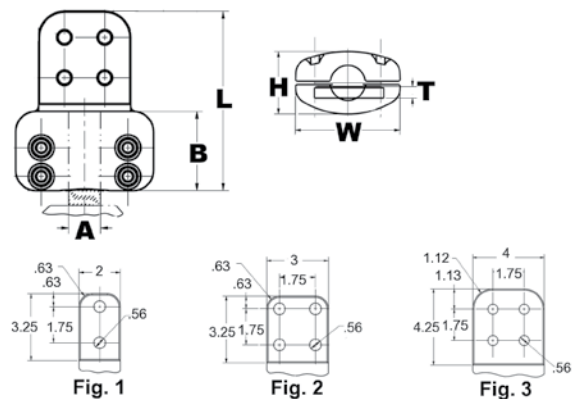

Catalog Number	Fig. #	Stud A	Threads per inch	B	H	L	W	T
SFD67D12	3	1-1/2	12	2.50	2.79	7.66	4.50	.75
SFD70AD16	3	3		3.84	4.10	8.59	7.12	1.00
SFD71AD16	3	3-1/2		3.84	4.89	8.59	7.50	1.00
SFD72AD20	3	4		3.84	5.37	8.58	8.12	1.25

Substation - Bolted

Aluminum Spacers, Two Cables Rigid Spacer, Type CPR-A
Two Cables Rigid Spacer w/Grounding Rod; Type S2GGBP-A

Aluminum Spacer, Type CPR-A For Two Cables Rigid Spacer

Material: Aluminum Alloy

Hardware: Aluminum

Rigid spacer for large range of cables. Particularly appropriate design for short spacing (up to 6" or 8").

Notes :

- PENETROX™ A joint compound is recommended on contact surfaces
- Please contact factory for other sizes, combinations and availability
- One-wrench installation



Catalog Number	Aluminum Stranded	B	J Dia.	U
CPR42A4	600 kcmil-900 kcmil	1.75	1/2	4.00
CPR46A4	1200 kcmil-1600 kcmil	2.13	5/8	4.00

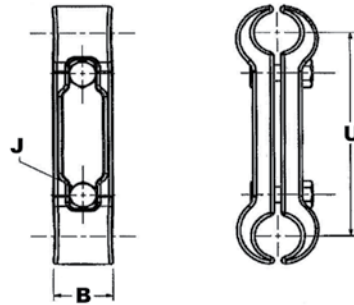

Aluminum Spacer, Type S2GGBP-A For Two Cables Rigid Spacer with Grounding Rod

Material: Aluminum Alloy

Hardware: Aluminum

Streamlined rigid spacer for large range of cables. The rod joining both cable modules is circular to accommodate grounding clamps.

EHV RATED: SELF-SHIELDING UP TO 550kV

Notes :

- PENETROX™ A joint compound is recommended on contact surfaces
- One wrench installation
- Please contact factory for other sizes, combinations and availability
- 1, 2 or 4 bolt designs available.

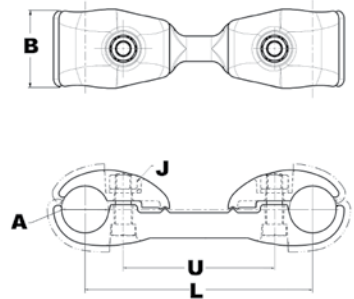

Catalog Number	Aluminum Stranded	Aluminum ACSR	B	J Dia.	U	L
S2GGBP486A9	2300 kcmil- 2500 kcmil	2156 (84/19) Bluebird kcmil- 2167 (72/7) Kiwi kcmil	3.12	5/8	9.00	11.50

BARTAP™ Connectors, Type QGFL
For Copper Cable to Flat

Material: Copper Alloy

High copper alloy BARTAP™ for joining a range of cable to bar or pad. One-wrench installation.

Notes :

- Can be installed side by side or in-line on NEMA drilled bar

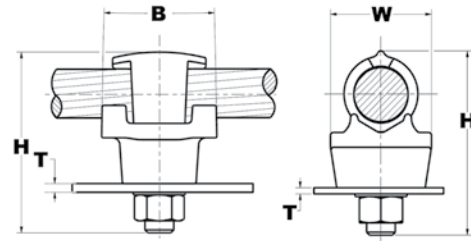

Catalog Number	Copper Conductor	B	H	J Dia.	T (Max)	W
QGFL1CB1	#10 Sol-#1 Str	1-1/8	1-7/8	3/8	1/4	1
QGFL1CB1T6	#10 Sol-#1 Str	1-1/8	2-3/8	3/8	3/4	1
QGFL26B1	#8 Sol-#2/0 Str	1-1/4	2-1/8	3/8	1/4	1-1/8
QGFL26B1T6	#8 Sol-#2/0 Str	1-1/4	2-5/8	3/8	3/4	1-1/8
QGFL26B2	#8 Sol-#2/0 Str	1-1/4	2-8/25	1/2	1/4	1-1/8
QGFL26B2T6	#8 Sol-#2/0 Str	1-1/2	2-4/5	1/2	3/4	1-1/8
QGFL29B1	#6 Str-250 kcmil	1-2/5	2-5/8	1/2	1/4	1-3/8
QGFL29B1T6	#6 Str-250 kcmil	1-5/8	3-1/8	1/2	3/4	1-3/8
QGFL31B1	2 AWG-350 kcmil	1-3/4	2-7/8	1/2	1/4	1-5/8
QGFL31B1T6	2 AWG-350 kcmil	1-3/4	3-1/4	1/2	3/4	1-5/8
QGFL34B1	1/0 -500 kcmil	2	3-1/8	1/2	1/4	1-3/4
QGFL34B1T6	1/0 -500 kcmil	2	3-5/8	1/2	3/4	1-3/4
QGFL44G3	2/0 - 1000 kcmil	1.88	4.44	1/2	3/4	2
QGFL39B1	350 kcmil-750 kcmil	2-1/4	3-1/4	1/2	1/4	1-3/4
QGFL39B1T6	350 kcmil-750 kcmil	2-1/4	3-5/8	1/2	3/4	1-3/4
QGFL44B1	750 kcmil-1000 kcmil	2-1/4	3-3/8	1/2	1/4	2-1/8
QGFL44B1T6	750 kcmil-1000 kcmil	2-1/4	4-1/8	1/2	3/4	2-1/8
QGFL46B1	1000 kcmil-1500 kcmil	2-1/4	4	1/2	1/4	2-1/2
QGFL46B1T6	1000 kcmil-1500 kcmil	2-1/4	4-1/2	1/2	3/4	2-1/2
QGFL48B1	1500 kcmil-2000 kcmil	2-1/4	4-3/4	1/2	1/4	3

Copper Bolted Terminal Type NFXR

For Pipe or Cable to Flat

Material: Copper Alloy

Hardware: DURIMUM™ Silicon Bronze

One of the most versatile products available. Can be bolted to a four-hole NEMA drilled pad. Rated for 230kV.

Notes :

- Plated versions: add the required suffix to the catalog number. -TN for regular tin plating
- Please contact factory for other sizes, combinations and availability

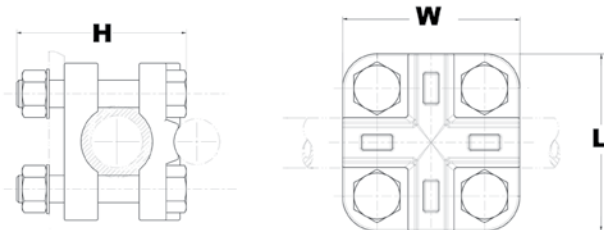

Catalog Number	Copper Cable	Copper Pipe (Std or EH)	H	L	W
NFXR15	1/0 -1250 kcmil	1/4 IPS-1 IPS	3.11	2.88	2.88
NFXR15CG20	1/0 -1250 kcmil		3.11	2.88	2.88
NFXR15CG24	1/0 -1250 kcmil		3.61	2.88	2.88
NFXR15CG7	1/0 -1250 kcmil		3.36	2.88	2.88

Bar Clamps, Type HFBW
For Copper Bar to Bar

Material: Copper Alloy

The clamp assembly eliminates the need for drilling the flat bar and may be used in either indoor and outdoor applications. The open web design provides a uniform clamping pressure while minimizing the weight of the connector.

Notes :

- Please contact factory for other sizes, combinations and availability.

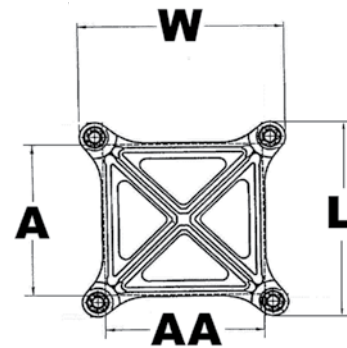
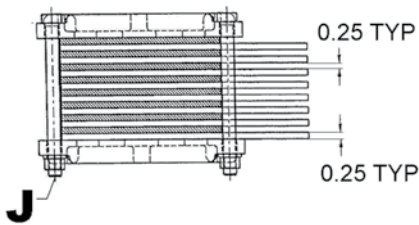
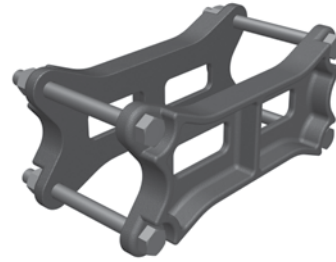

Catalog Number	A	AA	J Dia.	L	W
HFB44G30W	4.00	4.00	1/2	5.75	5.75
HFB44G31W	4.00	4.00	1/2	5.75	5.75
HFB44G32W	4.00	4.00	1/2	5.75	5.75

Bar Clamp Assembly Components, Type HFB-P1 For Copper Bar to Bar

Material: Copper Alloy

To build your own high strength clamp assembly for multiple flat bar using type HFB-P1 bar clamps and clamping hardware, the following tables have been provided. The clamp assembly eliminates the need for drilling the flat bar and may be used in either indoor and outdoor applications. Hardware not included.

Notes :

- For other sizes and availability, please contact factory.

Catalog Number	A	AA	J Dia.	L
HFB22P1	2.00	2.00	3/8	4.38
HFB33P1	3.00	3.00	3/8	4.38
HFB44P1	4.00	4.00	1/2	5.75
HFB54P1	5.00	4.00	1/2	6.75
HFB55P1	5.00	5.00	5/8	7.13
HFB62P1	6.00	2.00	1/2	7.75
HFB63P1	6.00	3.00	1/2	7.75
HFB64P1	6.00	4.00	1/2	7.75

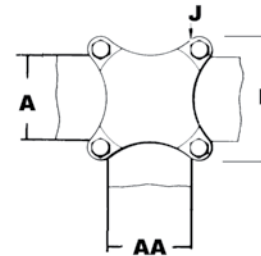
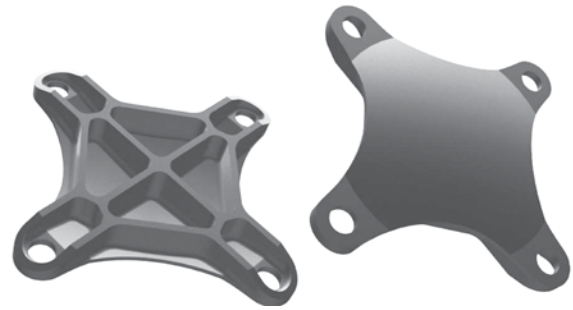

Bar Clamp Tap Pad Adapters, Type HFB-N For Copper Bar to Pad

Material: Copper

High conductivity copper, tap pad adapter provides a NEMA drilled contact pad when assembled to the HFB-P1 clamps (sold separately). Tap connections can be made from copper bus bar(s) without drilling, by bolting standard mechanical or compression terminal pads directly to the pre-drilled tap pad adapter.

Notes :

- **HFB-N items are only the flat drilled copper adapter pad, the HFB-P1 clamps and hardware are sold separately**
- Please contact factory for other sizes, combinations and availability

Catalog Number	Fig.	A	C	L	N
HFB334N	1	3.00	3.00	7.00	0.62
HFB444N	1	4.00	4.00	9.12	1.12
HFB666N	2	6.00	6.00	11.31	1.12

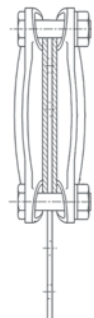
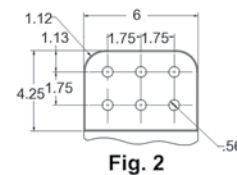
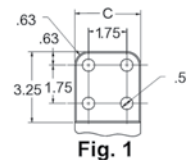
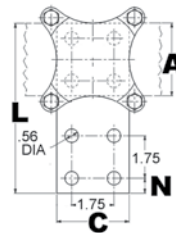
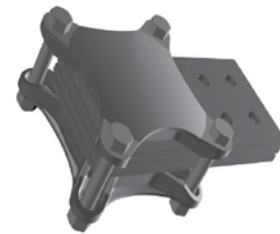

Table of Contents

EHV Substation Connectors Introduction	M-2	Welded T or "A" Frame Connectors	
BURNDY® Design Criteria	M-2	Type SWAB-A-N, Bus to pad	M-13
Cable Connectors	M-2	Type SWT-A-A, Bus to bus T connector	M-14
Tubular Bus Connectors	M-2	Type SWT-A-A-75, Bus "A" frame connector, 75° angle.....	M-15
Controlling Corona	M-2	Type SWAT-A-A-30, Bus "A" frame connector, 30° angle.....	M-16
Nomogram - Determining Equivalent Height	M-3	Welded Bus Supports	
Controlling Corona (continued).....	M-4	Type SWOH-A, Fixed bus support to insulator.....	M-17
Gradient Calibrator	M-4	Type SWHRH-A, Fixed or slip fit bus support to insulator	M-18
Formula for Determining Voltage Gradient.....	M-5	Type SWXHP-A, Bus to bus expansion support coupler to insulator.....	M-19
Nomogram - Finding Average Conductor-Surface Voltage-Gradient from Line Dimensions and Voltage	M-6	Miscellaneous	
Radio Interference Voltage.....	M-7	Type SWL-A, Bus to bus elbow, 90°	M-20
Effect of Conductor Size on Testing.....	M-7	Type WSBC-A, Spherical Coupler	M-21
Contamination.....	M-7	Type STS-A-NCG, Terminal Pad Cap (one piece).....	M-21
Conclusion.....	M-7	Type WLB-A, Bus to end cap	M-22
Welded Terminal Connectors		Type SCB-A, Bus to corona bell.....	M-22
Type SWA-R-N, Cable to two or four hole pad (offset terminal).....	M-8		
Type SW2A, Two Cables to two or four hole pad (offset terminal).....	M-9		
Type SWA-A-N, Bus to two or four hole pad (offset terminal).....	M-10		
Type SWAC-A-N, Bus to two or four hole pad (center formed).....	M-11		
Welded Couplers			
Type WS-A, Bus to bus coupler	M-12		

**Numerous Additional Connection Options Are Available.
Contact Customer Service
or
View the BURNDY Substation Catalog for
Additional Information**

EHV Substation Connectors Introduction

Connectors for use in EHV Substations must meet essentially the same electrical and mechanical requirements as those for other power connectors. However, operations at extra high voltages imposes an important additional requirement. They must not produce corona discharges that interfere with radio reception and cause energy loss.

Corona forms when the voltage gradient at the surface of a conducting material exceeds a critical value and ionizes the surrounding air. For conductors, the four basic factors that determine surface voltage gradient are distance from ground, conductor diameter, phase spacing and voltage.

In A.C. circuits, there are two basic kinds of corona. Negative corona forms during the negative half cycle, and positive corona during the positive half cycle. Negative corona generally appears as a glow on conventional conductors at about 20 kV rms/cm. Its amplitude is relatively low and cause no significant radio interference. Positive corona appears as a plume at above 30 kV rms/cm. Its amplitude is about 50 times higher than that for negative corona and is the major cause of radio interference.

BURNDY® EHV connectors are designed so that under fair weather operation conditions the voltage gradient at the connector surface will be at a level that will not cause corona and the resultant radio interference. (RIV)

BURNDY® Design Criteria

Cable Connectors

For reasons of economy, EHV systems using stranded conductor are generally designed to operate at voltage gradients close to the negative corona onset level. It is essential, therefore, that connectors provide corona-free performance superior to that of the cable. So our design criterion calls for the voltage which corona extinguishes from the connector to be higher than the voltage at which it extinguishes from the cable. This criterion is met by eliminating all protrusions and by providing smooth contours on all surfaces. On compression elements, the ends are especially critical. Carefully designed tapers are provided to keep the voltage gradient at a level lower than that on the conductor. Of course, it is still necessary during installation to smooth crimped elements.

On accessories, like spacers for bundled lines, the critical areas are those at the edges of the bundle. The bundle itself generally shields those parts that fall within it. Many protrusions that would cause corona on a single conductor line are quiet when they fall within the shielding influence of a bundle. However, those parts that fall at the edges are carefully finished at the factory to assure corona-free operation.

Tubular Bus Connectors

Station designers choose tubular bus sizes on the basis of mechanical rather than electrical requirements. For instance, stations that only need 4" IPS to meet electrical and corona requirements often have 6" IPS as main buses. The resultant voltage gradient on these buses is very low, perhaps only 10 kV rms/cm, well below the corona onset level.

It is impractical therefore, to require that connectors operate quieter than the bus regardless of the voltage. Under some circumstances, it might be impossible to meet such criteria. In most cases, it would be prohibitively expensive to do so.

Of course, theoretically optimum connectors could be designed for each application, based on the design voltage gradient for individual stations. However, in most cases even differences as great as that between 345 and 500 kV don't have a meaningful impact on connector costs. So, from a practical point of view, it is feasible to design most connectors for 500 kV operation. This makes it more convenient for the station designers to select and order connectors.

Bus connectors are designed to provide corona-free performance under conditions of actual operation. This is done by calculating the voltage gradient on the surface of the bus at 500 kV, using the phase spacing and ground distance typical for this voltage. Connectors are then designed to operate corona free when the voltage gradient on the bus is 10% above this value.

The exceptions to this rule are the flexible expansion connectors. Those designed for 345 kV are self-shielding. Those for 500 kV have separate shielding rings. Experimental work on self-shielding 500 kV expansion connectors indicates that the margin of safety is too small to justify recommending them for this voltage.

Controlling Corona

Since corona is caused when the voltage gradient at the surface of a conducting material reaches a level that causes the surrounding air to break down, then obviously, the way to prevent corona is to keep the gradient below this critical level.

From this point of view the connector designer, this can be accomplished in three ways:

1. By providing generous radii on all outside surfaces to keep the voltage stresses to a minimum.
2. By providing shielding rings.
3. By placing the connector within the shielding influences of some part of the bus structure.

Since it is impossible for the connector designer to know the exact configuration of every bus system where the connectors might be used, the third approach is not practical. So, for the purposes of developing a standard line, we concentrate on the first two.

Whenever possible, connectors are designed to be self-shielding. This approach leads to less costly and less obtrusive designs. BURNDY® EHV designs only use corona rings in complicated connector configurations. Examples of such applications are disconnectable equipment taps, expansion couplers and equipment terminals which often have configurations that preclude the use of self-shielding designs.

Nomogram for Determining the Equivalent Height

HEIGHT (h_e) OF A THREE PHASE LINE

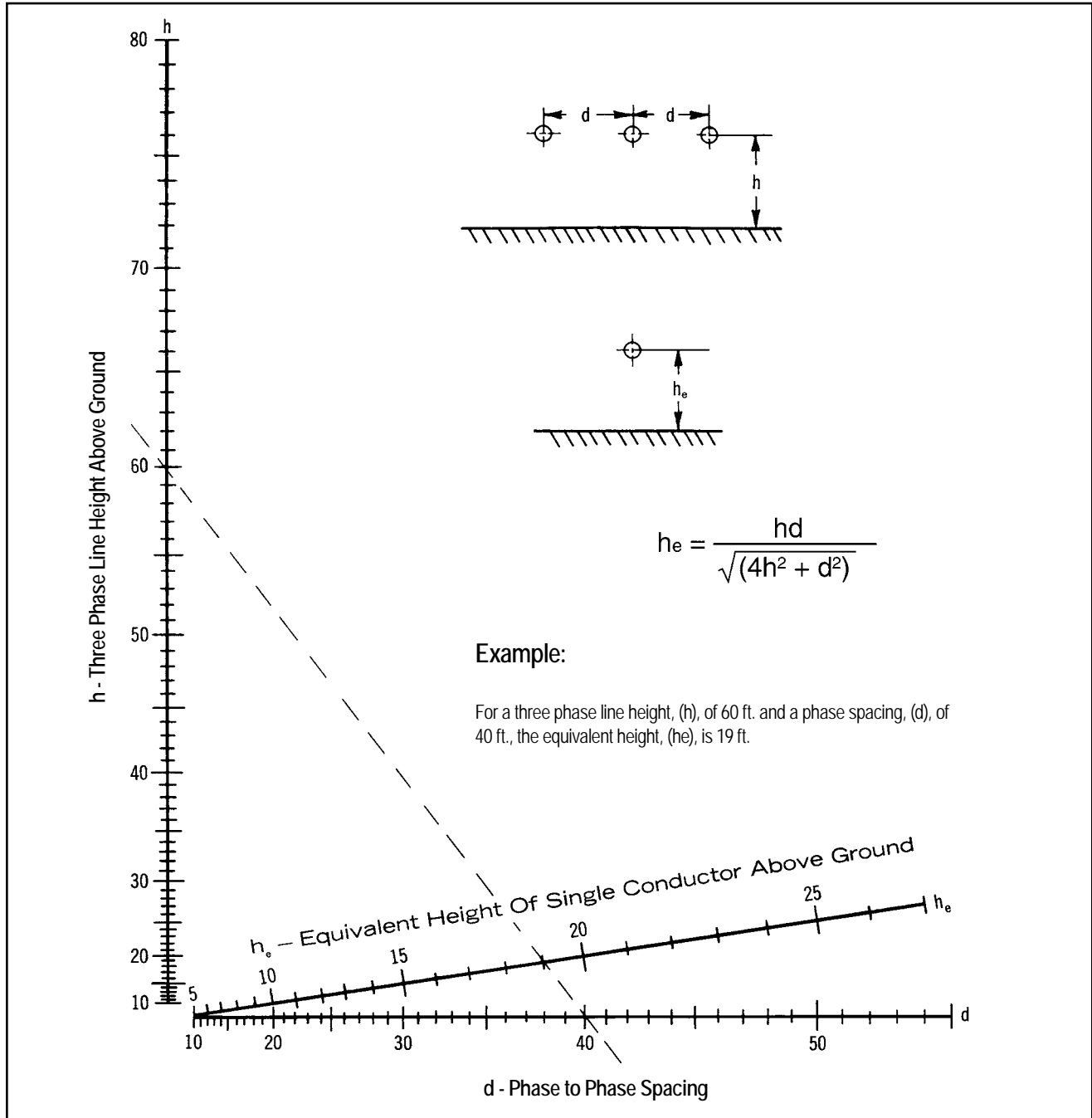

Nomogram for determining the equivalent height of a single conductor line having the same average voltage of gradient as the CENTER conductor of a horizontally spaced three phase line, with the same line to ground voltage and the same conductor size. All dimensions measured in the same units.

The use of the laboratory is based on the fact that it is the surface voltage gradient that causes corona. Although most systems consist of 3 phase conductors and a ground plane, it is a rather simple matter to duplicate in the laboratory the conductor surface voltage gradient as it exists on any of these phase conductors with a single conductor and a ground plane.

The formulas and nomograms give this three phase to single phase equivalency. Because this conversion is possible, all EHV testing is done single phase; and there is no necessity for 3 phase testing with its high cost in terms of equipment and space.

Since voltage gradient is the significant factor, the single phase test does not have to be done at the full voltage of an operation system. By setting up the test closer to the ground plane, the operation voltage gradient can be obtained with a lower test voltage. There is a limit, however, below which the height cannot be lowered lest corona onset and flashover occur simultaneously. Generally, the minimum test height should be about 10 times the diameter of the test conductor.

Gradient Calibrator

Normally the conductor surface voltage gradient at the extinction of corona in the laboratory is calculated using the accompanying equations. However, for test setups involving unusual conductor configurations, the conductor gradient cannot be readily calculated. In these cases, a gradient calibrator may be used. This is a small sphere mounted on the conductor. It has previously been calibrated for each conductor size to establish the surface voltage gradient that starts positive corona on the sphere. With it tests can be duplicated in any number of laboratories. The applied voltages and ground distances could all be different. But the voltage gradient on the surface of the conductor when the corona occurs on the sphere will always be the same. The calibrator provides a convenient bench mark for measuring the corona performance of connectors.

In use, the sphere is mounted on the conductor in a connector test setup. The voltage is raised until there is a corona on the sphere. We already know from previous calibration what the voltage gradient on the surface of the conductor is at this point.



The sphere is removed and the voltage raised until there is a corona on the connector. Since the voltage gradient increases directly with increases in applied voltage, the gradient on the conductor at this point can be readily calculated.

It is important to note that the significant parameter is the voltage gradient on the surface of the conductor. It is not necessary to know the gradient on the connector. The conductor gradient in any given substation is controlled by its design parameters and may be calculated using the following formulae and nomograms. Once the gradient is known, it is unnecessary to have any other information to design connectors. As long as connectors are corona-free at a conductor voltage gradient higher than that planned for the conductor, the connector will be corona-free under fair weather operating conditions.

There may be on occasion be unusual situations where choice of *conductor*, station geometry or clearance problems cause the need for connectors of special design. Where this is the case, BURNDY is prepared to design corona-free devices to operation under such conditions.

Formula for Determining the Voltage Gradient

Notations Used

h = line to ground distance (cm)
r = radius of the individual conductor (cm)
s = conductor spacing in the bundle (cm)
d - phase to phase spacing of the line (cm)
V = line to ground voltage (kV)
E_a = average gradient at the surface of the conductor (kV/cm)

E_m = maximum gradient on the surface of a single conductor
h_e = equivalent single phase line to ground distance (cm)
r_e = equivalent single conductor radius (cm) of bundled conductors
n = number of conductors in the bundle

$$E_a = \frac{V}{r \cdot 1n \cdot \frac{2h}{r}} \quad E_m = \frac{h}{h - r} E_a$$

The maximum gradient (E_m) occurs on the side facing the ground plane.

The center conductor has a gradient about 5% higher than the outside conductors. The gradient on the center phase may be calculated using the formula for the single conductor.

Single phase system and substituting (h_e) from the following formula or attached nomograms for the height about the ground (h). For the center phase:

$$E_a = \frac{V}{r \cdot 1n \cdot \frac{2h}{r}} \quad h_e = \frac{hd}{\sqrt{(4h^2 + d^2)}}$$

It should be noted that h_e is somewhat smaller than $\frac{d}{2}$

$$E_a = \frac{V}{n r \cdot 1n \cdot \frac{2h}{r_e}} \quad \text{in which } r_e = r \left(\frac{s}{r} \right)^{\frac{n-1}{n}}$$

The value of " ℓ " is unity for 1-, 2-, and 3- conductor bundles and 1.12 for 4- conductor bundles.

Bundled Conductor - Three Phase

This case may be reduced to the single bundled conductor case by replacing h with h_e in the equation. The definition of h_e is identical to that given for the single conductor — three phase situation.

Nomogram for finding the average conductor-surface voltage-gradient from line dimensions and voltage

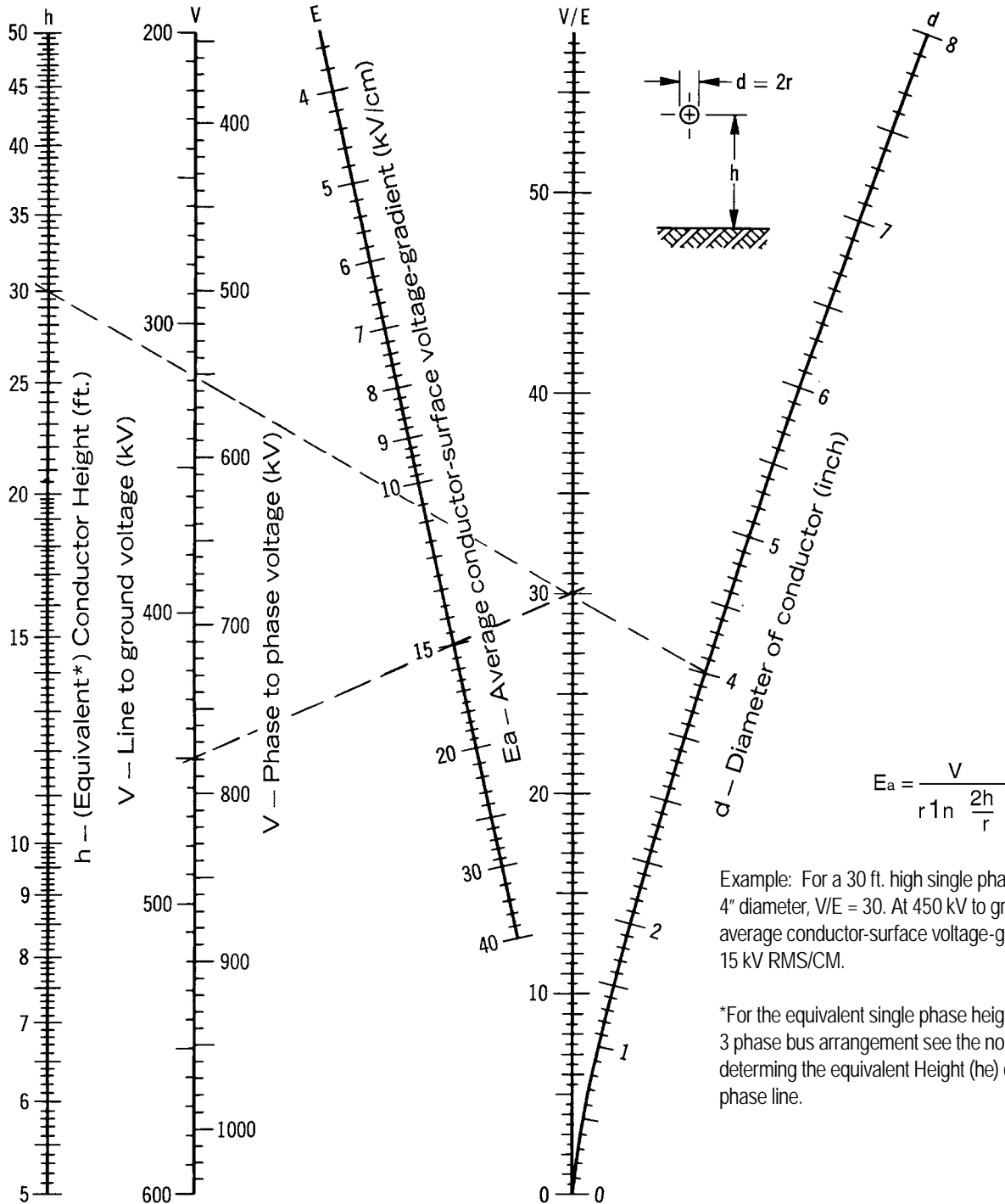

Radio Interference Voltage

There is serious question as to whether measurement of RIV on connectors makes a meaningful contribution to quieter station operation.

Under test conditions, there is generally no significant indication on the radio noise meter until the onset of visible positive corona. At this point, the RIV reading goes into the hundreds of thousands of microvolts. The effect of this phenomenon is to provide a visibly discernable point at which RIV will be excessive. It eliminates the necessity to make, record and plot RIV measurements. Where there is no corona, there is no RIV. So our test criterion calling for no visible corona assures that there will be no radio interference generated by the connector under operating conditions.

Effect of Conductor Size on Testing

Conductor diameter has a significant effect on potential corona problems. The larger the diameter, the lower the surface voltage gradient for a given test voltage. This means that smaller conductors produce corona at lower voltages than larger ones.

Many connector designs have the same basic configuration for various conductor sizes. The only difference being the size of the attaching elements. This is particularly true for many of the welded type connectors. Where this is the case, it is often sufficient to test the connector only on the smallest conductor, since it yields the lowest corona extinction voltage. When there is any doubt, each size is tested.

Contamination

Much work has been done to establish the relationship between the corona onset voltage for contaminated as compared to clean hardware. Experiments with contaminated hardware in the BURNDY laboratory indicate that corona onset can be reduced to half of the voltage for clean hardware. However, the relationship varies with the kind of contamination, atmospheric condition and type of connector.

There have been a number of attempts to produce artificial contamination and atmospheres in laboratories. However, there is as yet no clearly established relationship between the corona performance of hardware contaminated in the laboratory. Until such a relationship is established, the only testing that provides comparable data is on clean hardware under fair weather conditions.

Conclusion

For more than 90 years, BURNDY has been designing connectors for the industry's most critical applications. Connectors for EHV are an outgrowth of this tradition. Whether your need is for catalog items or special designs, you can count on electrical, mechanical and corona-free performance, commensurate with the application.

TYPICAL CURVE

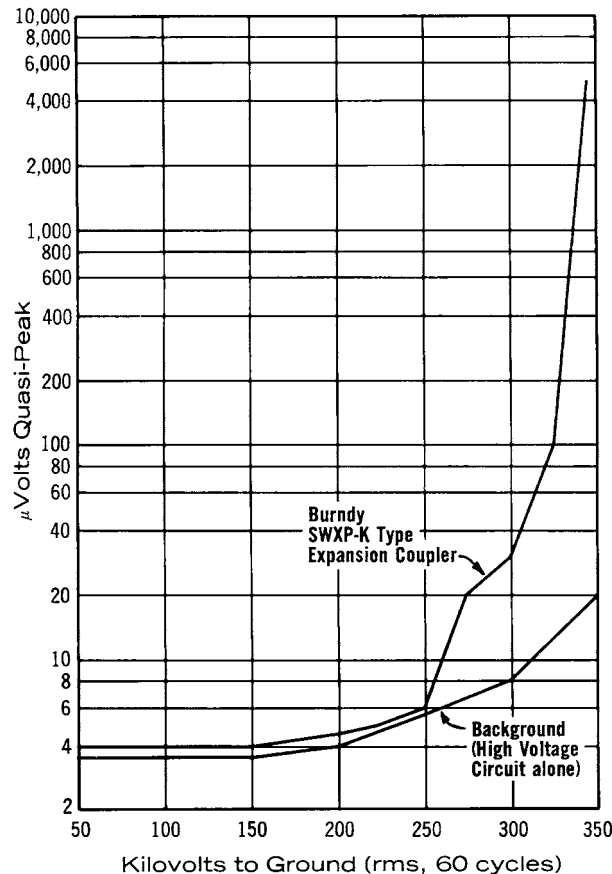

Substation - Welded/EHV

Welded Terminal Connector
Type SWA-R-N

Welded Terminal Connector, Type SWA-R-N For Cable to Two or Four Hole Pad (offset terminal)

Material: Cast 365 Aluminum Alloy

EHV Rated: up to 550 kV
when used with shielding caps

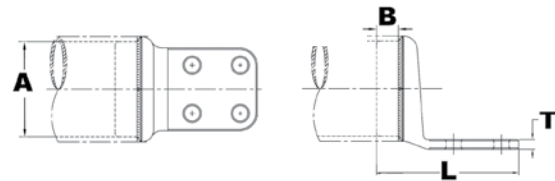
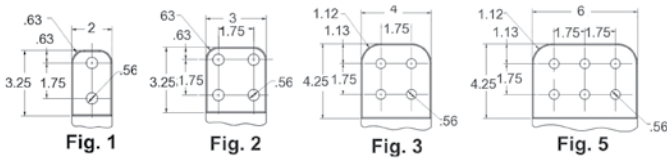
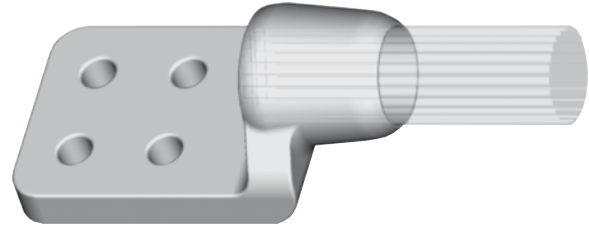

Catalog Number	Accommodates "A" Dia.		Str.	Max. Dia.	Max. Dia.	Fig. No.	B	L	T
	Alum. Cable	ACSR Cable							
SWA58R44N	1700 kcmil thru 1900 kcmil	1510.5 kcmil thru 1780 kcmil	54-49 54-19	1.471 [37]	1.605 [41]	3	2.50 [64]	7.25 [184]	0.69 [18]
SWA444A44N	900 kcmil thru 1100 kcmil	795 kcmil thru 954 kcmil	54-7	1.086 [28]	1.210 [31]	3	1.75 [44]	6.56 [167]	0.50 [13]
SWA486A44N	2300 kcmil thru 2500 kcmil	2156 kcmil thru 2300 kcmil	84-19 96-19	1.741 [44]	1.875 [48]	3	2.62 [67]	7.50 [191]	1.12 [28]

NOTES:

1. Dimensions in brackets [] are in millimeters.
2. **DOES NOT INCLUDE SHIELDING CAPS.** For EHV applications, shielding caps are required.
3. Shielding caps may be ordered separately or add suffix '-STS' to catalog number (example: SWA54R-44NSTS), includes one Type STS shielding cap.
4. One surface of pad finished. For finished pad on both sides add suffix '-Q' to the catalog number (example: SWA22A-44NQ).
5. For 45 or 90 degree angle add suffix '-45' or '-90' to catalog number (example: SWA54R-44N90).

Welded Terminal Connector, Type SW2A For Two Cables to Two or Four Hole Pad (offset terminal)

Material: Aluminum Alloy

EHV Rated: up to 550 kV
when used with shielding caps

Aluminum alloy weld type terminal for joining a range aluminum cables to pad. Drilling in pad confirms to NEMA standards. PENETROX™ joint compound recommended on pad contact surfaces.

NOTES:

1. Welding to be done by customer
2. Before welding scratch brush connector and conductor contact surface dry, then apply an oxide inhibitor.
3. Please contact factory for availability of sizes.

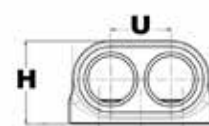
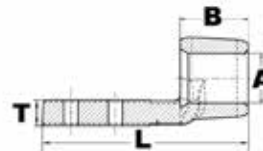
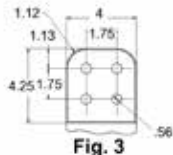
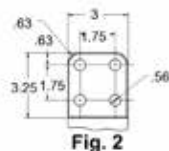
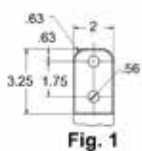

Catalog Number	Fig. #	A-Aluminum Stranded	A-Aluminum ACSR	B	U	L	H	T
SW2A444A44N90	3	900 kcmil-1000 kcmil	795 (54/7) Condor kcmil-954 (45/7) Rail kcmil	1.75	1.62	6.40	1.85	14/25
SW2A486A44N	3	2300 kcmil-2500 kcmil	2156 (64/119) kcmil-2312 (76/19) Thrasher kcmil	2.67	2.50	7.42	3.32	1
SW2A486A44N90	3		2156 (64/119) kcmil-2167 (72/7) Kiwi kcmil	2.67	2.50	7.97	2.77	1
SW2A486A66N90	—		2167 (72/7) Kiwi kcmil	2.67	2.50	8.62	2.77	1
SW2A48A44N	3	2000 kcmil-2250 kcmil	2167 (72/7) Kiwi kcmil	2.62	2.25	7.42	3.32	1
SW2A58R44N	3	1700 kcmil-1900 kcmil	1510.5 (45/7) Nuthatch kcmil-1780 (54/19) kcmil	2.50	2.10	7.25	2.75	3/4

Welded Terminal Connector, Type SWA-A-N For Bus to Two or Four Hole Pad (offset terminal)

Material: Cast 365 Aluminum Alloy

EHV Rated: up to 550 kV
when used with shielding caps

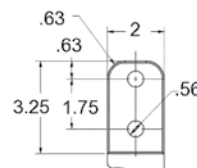
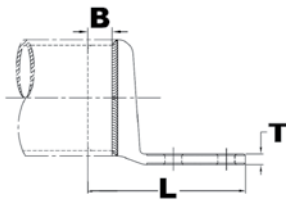
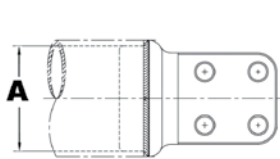

Fig. 1

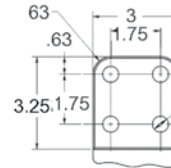

Fig. 2

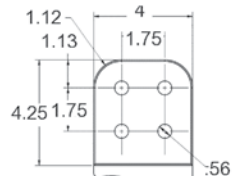

Fig. 3

Catalog Number		Accommodates "A" Dia. Alum. Tube	Fig.	B	L	T
IPS (Sch. 40)	EHPS (Sch. 80)					
SWA18A34N	—	2" (2.375 Dia.)	2	1.25 [32]	5.88 [149]	0.50 [13]
SWA18A44N	—	2" (2.375 Dia.)	3	1.25 [32]	6.95 [177]	0.50 [13]
SWA19A34N	—	2-1/2" (2.875 Dia.)	2	1.50 [38]	6.36 [162]	0.56 [14]
SWA19A44N	—	2-1/2" (2.875 Dia.)	3	1.50 [38]	7.40 [188]	0.56 [14]
SWA20A2N	—	3" (3.500 Dia.)	1	1.75 [44]	6.41 [163]	0.62 [16]
SWA20A34N	—	3" (3.500 Dia.)	2	1.75 [44]	6.41 [163]	0.62 [16]
SWA20A44N	SWA90A44N	3" (3.500 Dia.)	3	1.75 [44]	7.46 [189]	0.62 [16]
SWA21A44N	—	3-1/2" (4.000 Dia.)	3	1.75 [44]	7.47 [190]	0.62 [16]
SWA22A44N	SWA92A44N	4" (4.500 Dia.)	3	2.00 [51]	7.51 [191]	0.75 [19]
SWA23A44N	—	4-1/2" (5.000 Dia.)	3	2.00 [51]	7.77 [197]	0.75 [19]
SWA24A44N	—	5" (5.563 Dia.)	3	2.00 [51]	7.82 [199]	0.75 [19]
SWA86A44N	—	6" (6.625 Dia.)	3	2.50 [64]	7.90 [201]	1.00 [25]

NOTES:

1. Dimensions in brackets [] are in millimeters.
2. **DOES NOT INCLUDE SHIELDING CAPS.** For EHV applications, shielding caps are required.
3. Shielding caps may be ordered separately or add suffix '-STS' to catalog number (example: SWA22A44NSTS), includes one Type STS shielding cap.
4. One surface of pad finished. For finished pad on both sides add suffix '-Q' to the catalog number (example: SWA22A-44NQ).
5. For 45 or 90 degree angle add suffix '-45' or '-90' to catalog number (example: SWA22A-44N90).
6. For six hole NEMA pad contact factory.

Welded Terminal Connector, Type SWAC-A-N For Bus to Two or Four Hole Pad (center formed)

Material: Cast 365 Aluminum Alloy

EHV Rated: up to 550 kV
when used with shielding caps

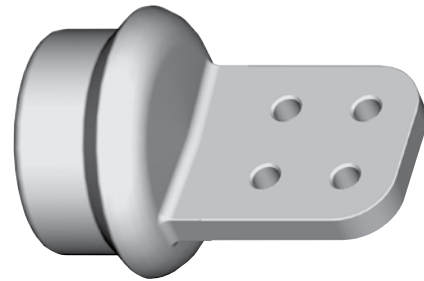

NOTES:

1. Dimensions in brackets [] are in millimeters.
2. Conductor smaller than 3 inch bus size not recommended for 550 kV
3. **DOES NOT INCLUDE SHIELDING CAPS.** For EHV applications, shielding caps are required.
4. Shielding caps may be ordered separately or add suffix '-STS' to catalog number (example: SWAC22A44NSTS), includes one Type STS shielding cap.
5. Pad surface finished on both sides of tongue.
6. For six hole NEMA pad contact factory.

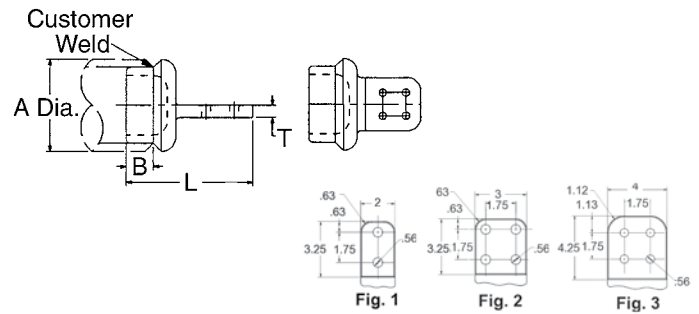

Catalog Number		Conductor		Fig. No.	Dimensions In.		
IPS (Sch. 40)	EHPS (Sch. 80)	IPS	A		B	L	T
SWAC18A2N	—	2"	2.38 [60]	1	1.25 [32]	5.80 [147]	0.50 [13]
SWAC18A34N	—			2	1.25 [32]	5.80 [147]	0.50 [13]
SWAC18A44N	—			3	1.25 [32]	6.86 [174]	0.50 [13]
SWAC19A2N	—	2-1/2"	2.88 [73]	1	1.50 [38]	6.23 [158]	0.56 [14]
SWAC19A34N	—			2	1.50 [38]	6.23 [158]	0.56 [14]
SWAC19A44N	—			3	1.50 [38]	7.29 [185]	0.56 [14]
SWAC20A34N	—	3"	3.50 [89]	2	1.75 [44]	6.30 [160]	0.62 [16]
SWAC20A44N	—			3	1.75 [44]	7.36 [187]	0.62 [16]
SWAC21A34N	—	3-1/2"	4.00 [102]	2	1.75 [44]	6.30 [160]	0.62 [16]
SWAC21A44N	—			3	1.75 [44]	7.36 [187]	0.62 [16]
SWAC22A44N	SWAC92A44N	4"	4.50 [114]	3	2.00 [51]	7.40 [188]	0.75 [19]
SWAC23A34N	—	4-1/2"	5.00 [127]	2	2.00 [51]	6.23 [158]	0.56 [19]
SWAC24A44N	SWAC94A44N	5"	5.56 [141]	3	2.00 [51]	7.72 [196]	0.75 [19]
SWAC86A44N	SWAC96A44N	6"	6.62 [168]	3	2.50 [64]	7.75 [197]	1.00 [25]

Welded Rigid Coupler, Type WS-A Bus to Bus Coupler

Material: Cast 356 Aluminum Alloy

EHV Rated: Self-Shielding up to 550 kV

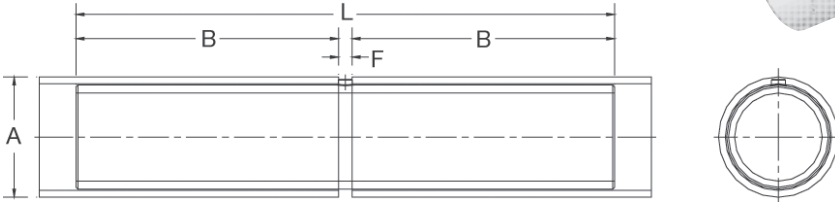
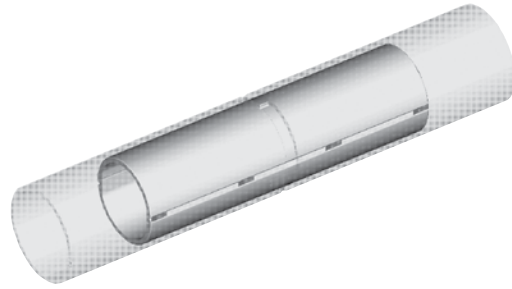

Catalog Number	Conductor (IPS) "A" Schedule 40	Conductor (EHPS) "A" Schedule 80	Dimensions Inches		
			B	F	L
WS14A	3/4" (1.050 Dia.)	—	2.13 [54.1]	0.23 [5.8]	4.50 [114.3]
WS15A	1" (Dia.)	—	2.13 [54.1]	0.23 [5.8]	4.50 [114.3]
WS16A	1-1/4" (1.660 Dia.)	—	3.60 [91.4]	0.28 [7.1]	7.50 [190.5]
WS17A	1-1/2" (1.900 Dia.)	—	4.36 [110.7]	0.29 [7.4]	9.00 [228.6]
WS18A	2" (2.375 Dia.)	—	5.88 [149.4]	0.31 [7.9]	12.00 [304.8]
WS19A	2-1/2" (2.875 Dia.)	—	7.31 [185.7]	0.39 [9.9]	15.00 [381.0]
WS20A	3" (3.500 Dia.)	—	8.81 [223.8]	0.44 [11.2]	18.00 [457.2]
WS21A	3-1/2" (4.000 Dia.)	—	8.75 [222.3]	0.47 [11.9]	18.00 [457.2]
WS22A	4" (4.500 Dia.)	—	8.75 [222.3]	0.47 [11.9]	18.00 [457.2]
WS24A	5" (5.563 Dia.)	—	8.75 [222.3]	0.50 [12.7]	18.00 [457.2]
WS58A	6" (6.625 Dia.)	—	8.75 [222.3]	0.56 [14.2]	18.00 [457.2]
WS59A	—	2" (2.375 Dia.)	5.88 [149.4]	0.31 [7.9]	12.00 [304.8]
WS86A	—	2-1/2" (2.875 Dia.)	7.31 [185.7]	0.39 [9.9]	15.00 [381.0]
WS90A	—	3" (3.500 Dia.)	8.81 [223.8]	0.44 [11.2]	18.00 [457.2]
WS91A	—	3-1/2" (4.000 Dia.)	8.75 [222.3]	0.47 [11.9]	18.00 [457.2]
WS92A	—	4" (4.500 Dia.)	8.75 [222.3]	0.47 [11.9]	18.00 [457.2]
WS94A	—	5" (5.563 Dia.)	8.75 [222.3]	0.50 [12.7]	18.00 [457.2]
WS96A	—	6" (6.625 Dia.)	8.75 [222.3]	0.56 [14.2]	18.00 [457.2]

NOTES:

1. Dimensions in brackets [] are in millimeters.
2. Conductor smaller than 3 inch bus size not recommended for 550 kV.

Welded T Connector, Type SWAB-A-N Bus to Pad

Material: Cast 356 Aluminum Alloy

EHV Rated: up to 550 kV
when used with Shielding Caps

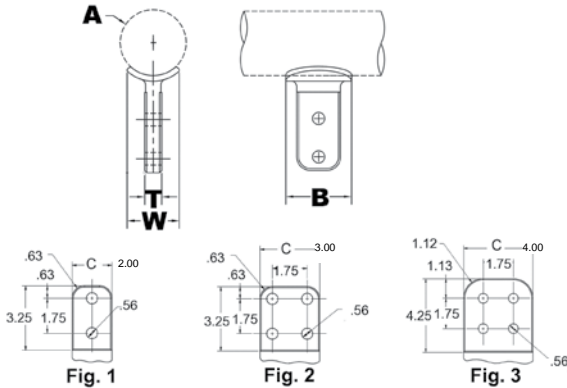

NOTES:

1. Dimensions in brackets [] are in millimeters.
2. Conductor smaller than 3 inch bus size not recommended for 550 kV
3. **DOES NOT INCLUDE SHIELDING CAPS.** For EHV applications, shielding caps are required.
4. Shielding caps may be ordered separately or add suffix '-STS' to catalog number (example: SWAC22A44NSTS), includes one Type STS shielding cap.
5. Pad surface finished on both sides of tongue.
6. For six hole NEMA pad contact factory.

Catalog Number	Complete Range Aluminum Tube	Fig. #	Dimensions - Inches					
			B	T	W	Aluminum IPS Pipe		
						Nominal	A	Y
SWAB19A2N	1" to 2-1/2"	1	3.00 [76]	0.38 [10]	1.32 [34]	1"	1.32 [34]	4.45 [113]
						1-1/4"	1.66 [42]	4.67 [119]
						1-1/2"	1.90 [48]	4.80 [122]
SWAB19A34N	1" to 2-1/2"	2	4.00 [102]	0.50 [13]	1.32 [34]	2"	2.38 [60]	5.08 [129]
						2-1/2"	2.88 [73]	5.32 [135]
SWAB22A2N	2-1/2" to 4"	1	3.00 [76]	0.75 [19]	2.40 [61]	2-1/2"	2.88 [73]	5.25 [133]
						3"	3.50 [89]	5.62 [143]
SWAB22A34N	2-1/2" to 4"	2	4.00 [102]	0.75 [19]	2.40 [61]	3-1/2"	4.00 [102]	5.92 [150]
SWAB22A44N		3	4.50 [114]	0.75 [19]	2.40 [61]	4"	4.50 [114]	6.21 [158]
SWAB86A34N	3" to 6"	2	4.00 [102]	1.00 [25]	2.62 [67]	5"	5.56 [141]	6.67 [169]
SWAB86A44N		3	4.50 [114]	1.00 [25]	2.62 [67]	6"	6.62 [168]	7.24 [184]

Substation - Welded/EHV

Welded T Connector
Type SWT-A-A

Welded T Connector, Type SWT-A-A Bus to Bus T Connector

Material: Cast 356 Aluminum Alloy

EHV Rated: Self Shielding up to 550 kV

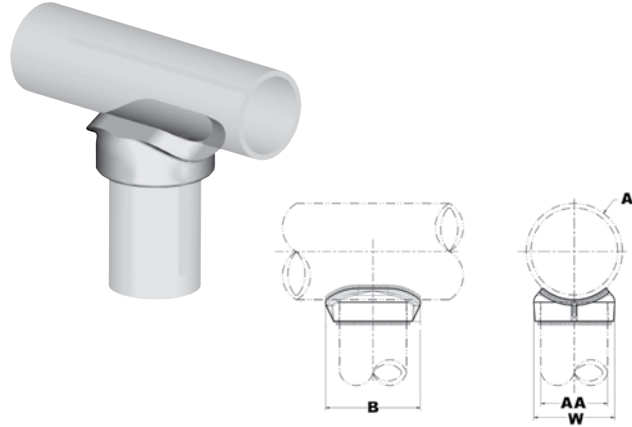

Catalog Number	Run 'A' Aluminum Tube	Tap 'AA' Aluminum Tube		Run Data		Dimensions Inches	
		Tube	AA	Nom. Tube	A	B	W
SWT17A17A	1-1/2"	1/2"	1.90 [48]	1-1/2"	1.90 [48]	3.19 [81]	2.64 [67]
SWT19A19A	2 1/2"	2-1/2"	2.88 [27]	2-1/2"	2.88 [73]	4.00 [54]	3.78 [96]
SWT21A17A	2" To 3-1/2"	1-1/2"	1.90 [48]	2"	2.38 [60.4]	3.19 [81]	2.62 [67]
				2-1/2"	2.88 [73]		
				3"	3.50 [89]		
				3-1/2"	4.00 [102]		
SWT21A18A	2" To 3-1/2"	2"	2.38 [60.4]	2"	2.38 [60.4]	4.00 [102]	3.33 [84]
				2-1/2"	2.88 [73]		
				3"	3.50 [90]		
				3-1/2"	4.00 [102]		
SWT21A20A	2" To 3-1/2"	3"	3.50 [90]	3"	3.50 [102]	4.56 [116]	4.52 [115]
				3-1/2"	4.00 [102]		
SWT22A18A	4"	2"	2.38 [60.4]	4"	4.50 [114]	4.00 [102]	3.50 [102]
SWT22A20A		3"	3.50 [102]			4.56 [116]	4.50 [114]
SWT22A21A		3-1/2"	4.00 [102]			5.50 [140]	5.00 [127]
SWT22A22A		4"	4.50 [114]			6.00 [152]	5.60 [142]
SWT24A20A	5"	3"	3.50 [48]	5"	5.56 [141]	4.72 [102]	3.50 [102]
SWT24A21A		3-1/2"	4.00 [102]			5.50 [140]	5.00 [127]
SWT24A24A		5"	5.56 [141]			7.38 [187]	6.84 [174]
SWT86A20A	6"	3"	3.50 [48]	6"	6.62 [168]	4.56 [116]	5.00 [127]
SWT86A24A		5"	5.56 [141]			7.38 [187]	6.84 [174]

NOTES:

1. Dimensions in brackets [] are in millimeters.
2. Conductor smaller than 3 inch bus size not recommended for 550 kV.

Welded T Connector, Type SWT-A-A-75 Bus "A" Frame Connector, 75°

Material: Cast 356 Aluminum Alloy

EHV Rated: Self Shielding up to 550 kV

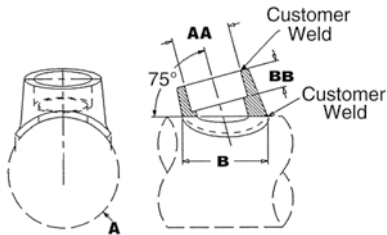

Catalog Number	Aluminum Tube				Dimensions In.	
	Run		Tap			
	Nominal	A	Nominal	AA	B	BB
SWT18A16A75	2"	2.38 [60.4]	1-1/4"	1.66 [42]	2.69 [68]	1.00 [25]
SWT19A17A75	2-1/2"	2.88 [73]	1-1/2"	1.90 [48]	3.19 [81]	1.00 [25]
SWT19A18A75	2-1/2"	2.88 [73]	2"	2.38 [60]	4.00 [102]	1.00 [25]
SWT20A18A75	3"	3.50 [89]	2"	2.38 [60]	4.00 [102]	1.00 [25]
SWT21A16A75	3-1/2"	4.00 [102]	1-1/4"	1.66 [42]	2.69 [68]	1.00 [25]
SWT21A18A75	3-1/2"	4.00 [102]	2"	2.38 [42]	4.00 [68]	1.00 [25]
SWT21A19A75	3-1/2"	4.00 [102]	1-1/2"	2.88 [73]	4.00 [68]	1.38 [35]
SWT22A18A75	4"	4.50 [114]	2"	2.38 [60]	4.18 [105]	1.00 [25]
SWT22A19A75	4"	4.50 [114]	1-1/2"	2.88 [73]	4.00 [102]	1.38 [35]
SWT22A20A75	4"	4.50 [114]	3"	3.50 [89]	4.56 [116]	1.38 [35]
SWT24A18A75	5"	5.56 [141]	2"	2.38 [60]	4.00 [102]	1.00 [25]
SWT24A19A75	5"	5.56 [141]	1-1/2"	2.88 [73]	4.00 [102]	1.38 [35]
SWT24A20A75	5"	5.56 [141]	3"	3.50 [89]	4.56 [116]	1.38 [35]
SWT86A20A75	6"	6.62 [168]	3"	3.50 [89]	4.56 [116]	1.38 [35]
SWT86A21A75	6"	6.62 [168]	3-1/2"	4.00 [102]	5.50 [140]	1.38 [35]
SWT86A22A75	6"	6.62 [168]	4"	4.50 [114]	6.00 [152]	1.38 [35]

NOTES:

1. Dimensions in brackets [] are in millimeters.
2. Conductor smaller than 3 inch bus size not recommended for 550 kV.

Substation - Welded/EHV

Welded V Connector
Type SWAT-A-A-30

Welded V Connector, Type SWAT-A-A-30
Bus "A" Frame Connector, 30°

Material: Cast 356 Aluminum Alloy

EHV Rated: Self Shielding up to 550 kV

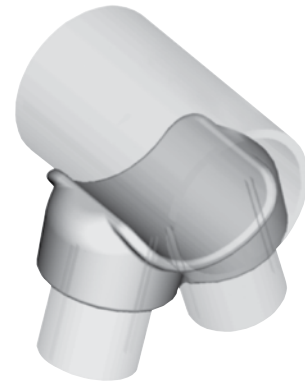

Catalog Number	Aluminum I.P.S.		B	B-B	W	Y	Z
	Run "A"	Tap "A-A"					
SWAT18A16A30	2" (2.375 Dia.)	1-1/4" (1.660 Dia.)	3.25 [83]	1.00 [25]	4.81 [122]	3.19 [81]	1.79 [45]
SWAT18A17A30		1-1/2" (1.900 Dia.)	3.50 [89]	1.00 [25]	5.25 [133]	3.00 [76]	2.34 [59]
SWAT18A18A30		2" (2.375 Dia.)	4.00 [102]	1.00 [25]	6.38 [160]	3.12 [71]	3.46 [88]
SWAT19A16A30	2-1/2" (2.875 Dia.)	1-1/4" (2.375 Dia.)	3.25 [83]	1.00 [25]	4.82 [122]	3.31 [84]	1.74 [44]
SWAT19A17A30		1-1/2" (1.900 Dia.)	3.50 [89]	1.00 [25]	5.25 [132]	3.28 [83]	2.00 [51]
SWAT20A17A30	3" (3.500 Dia.)	1-1/2" (1.900 Dia.)	3.50 [89]	1.00 [25]	5.12 [130]	3.44 [87]	1.87 [47]
SWAT20A18A30		2" (2.375 Dia.)	4.00 [102]	1.00 [25]	6.25 [159]	3.50 [89]	2.71 [69]
SWAT20A19A30		2-1/2" (2.875 Dia.)	4.38 [111]	1.38 [35]	7.19 [183]	3.88 [99]	3.41 [87]
SWAT21A18A30	3-1/2" (4.000 Dia.)	2" (2.375 Dia.)	4.00 [102]	1.00 [25]	6.31 [160]	3.16 [80]	2.68 [68]
SWAT21A19A30		2-1/2" (2.0875 Dia.)	4.38 [111]	1.38 [35]	7.38 [187]	4.00 [102]	3.09 [78]
SWAT22A18A30	4" (4.500 Dia.)	2" (2.375 Dia.)	4.00 [102]	1.00 [25]	6.50 [165]	3.81 [97]	2.82 [72]
SWAT22A19A30		2-1/2" (2.875 Dia.)	4.38 [111]	1.38 [35]	7.41 [188]	4.09 [104]	3.13 [80]
SWAT22A20A30		3" (3.500 Dia.)	5.12 [130]	1.38 [38]	8.62 [219]	4.28 [109]	4.05 [103]
SWAT24A19A30	5" (5.563 Dia.)	2-1/2" (2.875 Dia.)	4.38 [111]	1.38 [35]	7.38 [187]	4.47 [114]	2.87 [73]
SWAT24A20A30		3" (3.500 Dia.)	2.12 [130]	1.38 [35]	8.62 [219]	4.62 [117]	3.76 [96]
SWAT86A20A30	6" (6.625 Dia.)	3" (3.500 Dia.)	5.12 [130]	1.38 [35]	8.69 [221]	4.81 [122]	3.57 [91]
SWAT86A21A30		3-1/2" (4.000 Dia.)	5.88 [149]	1.38 [35]	9.69 [246]	5.19 [132]	4.11 [104]
SWAT86A22A30		4" (4.500 Dia.)	6.25 [159]	1.38 [35]	10.62 [270]	5.00 [127]	5.15 [131]

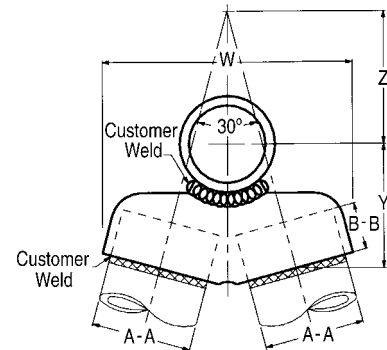
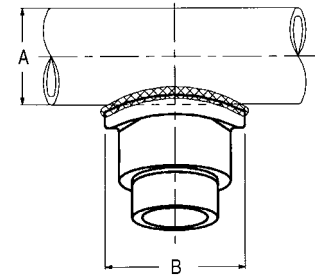

NOTES:

1. Dimensions in brackets [] are in millimeters
2. Conductor smaller than 3 inch bus size not recommended for 550 kV.

Welded Bus Support, Type SWOH-A
Fixed Bus Support to Insulator

Material: Cast 356 Aluminum Alloy

EHV Rated: Self Shielding up to 550 kV
when used on Corona Free
Post Insulators

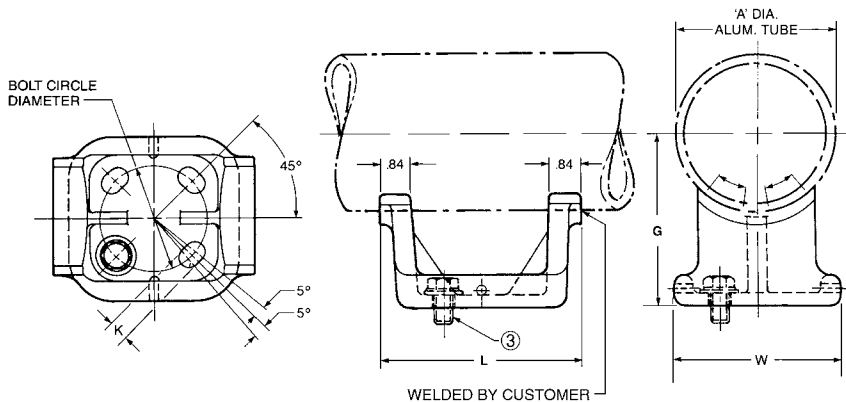
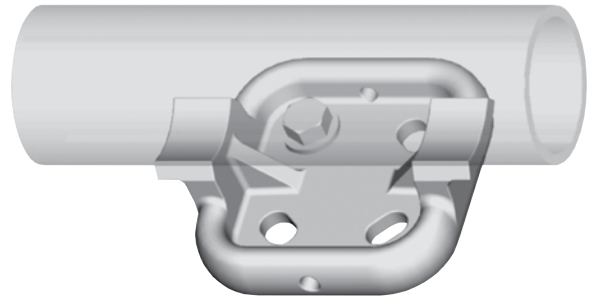

Catalog Number	"A" Dia. Alum. Tube	Bolt Circle Dia.	G	K	L	W
SWOH18A5	2.37" (2.375 Dia.) [60]	5.00 [127]	2.75 [70]	0.69 [18]	7.48 [190]	6.76 [172]
SWOH19A3	2-1/2" (2.875 Dia.) [73]	3.00 [76]	3.12 [79]	0.56 [14]	6.06 [154]	5.19 [132]
SWOH19A5		5.00 [127]		0.69 [18]	7.62 [194]	6.80 [173]
SWOH20A5	3" (3.500 Dia.) [89]	5.00 [127]	3.00 [76]	0.69 [18]	7.20 [183]	6.29 [160]
SWOH24A5	5" [141]	5.00 [127]	5.00 [127]	0.69 [18]	7.68 [195]	6.57 [167]

NOTES:

1. Dimensions in brackets [] are in millimeters.
2. "G" dimension conforms to NEMA standards.
3. Cap mounting (galvanized steel) hardware supplied as standard. For Base Mounting hardware add '-B' suffix to catalog number (example: SWOH22A-5B).
4. Conductors smaller than 3 inch bus size not recommended for 550 kV

Welded Rigid or Slip Fit Bus Support, Type SWHRH-A

Fixed or Slip Fit Bus Support to Insulator

Material: Cast 356 Aluminum Alloy

EHV Rated: Self Shielding up to 550 kV
when used on Corona Free
Post Insulators

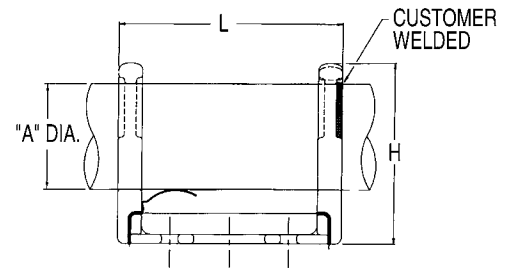
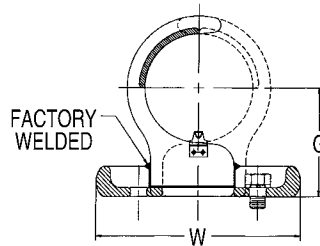
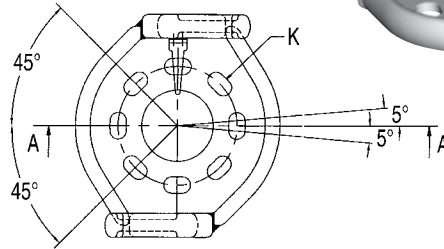
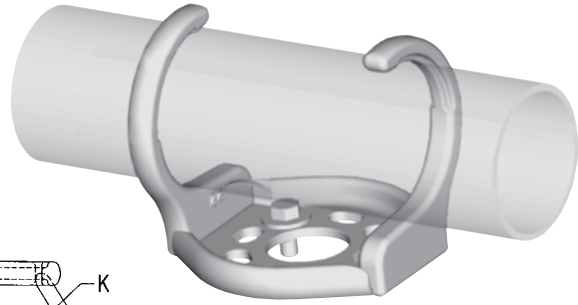

NOTES:

1. Dimensions in brackets [] are in millimeters.
2. "G" dimension conforms to NEMA standards.
3. Cap mounting (galvanized steel) hardware supplied as standard. For Base Mounting hardware add "-B" suffix to catalog number (example: SWHRH22A-5B).
4. Conductors smaller than 3 inch bus size not recommended for 550 kV

Catalog Number		Aluminum Conductor		G	H	3" Bolt Circle			5" Bolt Circle		
3" Bolt Circle	5" Bolt Circle	IPS/EHPS	"A" Dia.			K	L	W	K	L	W
SWHRH19A3CH	—	2-1/2"	2.88 [73]	3.12 [79]	5.21 [132]	0.56 X 0.75 [14 X 19]	7.76 [197]	6.62 [159]	0.69 X 0.88 [18 X 22]	9.37 [238]	8.61 [219]
SWHRH20A3CH	—	3"	3.50 [89]	3.62 [92]	6.15 [156]	0.56 X 0.75 [14 X 19]	7.76 [197]	6.62 [159]	0.69 X 0.88 [18 X 22]	9.37 [238]	8.61 [219]
—	SWHRH22A5CH	4"	4.50 [114]	4.50 [114]	7.52 [191]	0.56 X 0.75 [14 X 19]	7.76 [197]	6.62 [159]	0.69 X 0.88 [18 X 22]	9.37 [238]	8.61 [219]
—	SWHRH86A5CH	6"	6.63 [168]	5.50 [140]	9.71 [247]	0.56 X 0.75 [14 X 19]	7.76 [197]	8.61 [219]	0.69 X 0.88 [18 X 22]	9.37 [238]	8.61 [219]

Expansion Bus Support Coupler, Type SWXHP-A
Bus to Bus Expansion Coupler to Insulator

Material: Cast 356 Aluminum Alloy
Corona Rings: Aluminum Alloy
Straps: Laminated Aluminum Strap

EHV Rated: Self-Shielding up to 550 kV

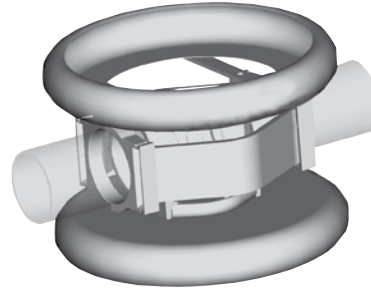

NOTES:

*Conforms to NEMA standards

1. Maximum movement per end equals one-half of total movement specified in table.
2. Dimensions in brackets [] are in millimeters.
3. Cap mounting (galvanized steel) hardware supplied as standard. For Base Mounting hardware add 'B' suffix to catalog number (example: SWXHP20A5B).
4. Conductors smaller than 3 inch bus size not recommended for 550 kV
5. Bus support couplers are supplied without bus end plugs. If end plugs are required, add suffix 'EP' to catalog number (example: SWXHP20A5EP)
6. Table 3" Movement Z Reference is based on 80 ft max. bus run (total) or 40 ft per end
7. Table 4" Movement Z Reference is based on 110 ft max. bus run (total) or 55 ft per end

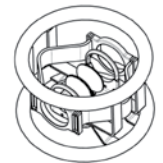
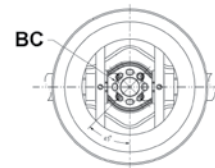
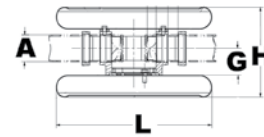

Catalog Number	"A" Dia. Alum. Tube	Bolt Circle Dia.	G*	H	L	Total Movement (note 1)
Sch 40						
SWXHP22A5	4" (4.50 Dia.) [114]	5.00 [127]	4.50 [114]	14.90 [18]		4.00 [102]
SWXHP24A5	5" (5.56 Dia.) [141]	5.00 [127]	5.25 [133]	16.31 [18]	26.00 [660]	4.00 [102]
SWXHP86A5	6" (6.63 Dia.) [168]	5.00 [127]	5.50 [140]	17.34 [18]		4.00 [102]

Installation Data		
Bus Temp F°	3" Total Movement	4" Total Movement
	Z (note 6)	Z (note 7)
-20	0.75	0.75
-10	0.82	0.84
0	0.89	0.83
10	0.95	1.02
20	1.02	1.11
30	1.09	1.20
40	1.16	1.29
50	1.23	1.39
60	1.30	1.48
70	1.36	1.57
80	1.43	1.66
90	1.50	1.75
100	1.57	1.84
110	1.64	1.93
120	1.70	2.02
130	1.77	2.11
140	1.84	2.20
150	1.91	2.29
160	1.98	2.39
170	2.05	2.48
180	2.11	2.57
190	2.18	2.66
200	2.25	2.75

NOMINAL POSITION

Welded Elbow, Type SWL-A
Bus to Bus Elbow, 90°

Material: Cast 356 Aluminum Alloy

EHV Rated: Self Shielding up to 550 kV

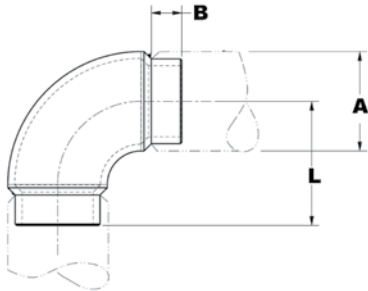

NOTES:

1. Dimensions in brackets [] are in millimeters.
2. Conductors smaller than 3 inch bus size not recommended for 550 kV
3. For 45° angle, add suffix '-45' to catalog number (example: SWL22A-45)

Catalog Number		Conductor Aluminum Tubing Size	Dimensions In./[mm]		
Sch. 40	Sch. 80		A Dia.	B	L
SWL18A	SWL58A	2"	2.38 [60.4]	1.00 [25]	3.50 [89]
SWL19A	SWL59A	2-1/2"	2.88 [73]	1.38 [35]	3.88 [99]
—	SWL90A	3"	3.50 [89]		4.68 [119]
SWL21A	SWL91A	3-1/2"	4.00 [102]		5.12 [130]
SWL22A	SWL92A	4"	4.50 [114]		5.63 [143]
—	SWL93A	5"	5.56 [141]	1.62 [41]	6.16 [156]
SWL86A	SWL96A	6"	6.63 [168]		6.16 [156]

Welded Spherical Coupler, Type WSBC-A

Streamlined, Variable Angle;
For Use on Aluminum Pipe to Pipe Connections

Material: Aluminum Alloy

EHV Rated: Self Shielding at operating voltages up to 500 kV



Catalog Number	Conductor Range	Max kV	A° Max	Ø B	Ø C	D
WSBC74A	1-1/2" SPS	230	130°	5.00 [127]	1.75 [44]	.31 [8]
	2" SPS		115°			
	2-1/2" SPS		105°			
	3" SPS		90°			
	3-1/2" SPS		80°			
	4" SPS		50°			
WSBC83A	3" SPS - 5" SPS	345	90°	8.00 [203]	2.75 [70]	.44 [11]
	6" SPS		60°			
	8" OD SPS		40°			
WSBC128A	3" SPS	500	140°	12.00 [305]	2.75 [70]	.38 [10]
	3-1/2" SPS		135°			
	4" SPS		130°			
	5" SPS		120°			
	6" SPS		100°			
	8" OD SPS		90°			

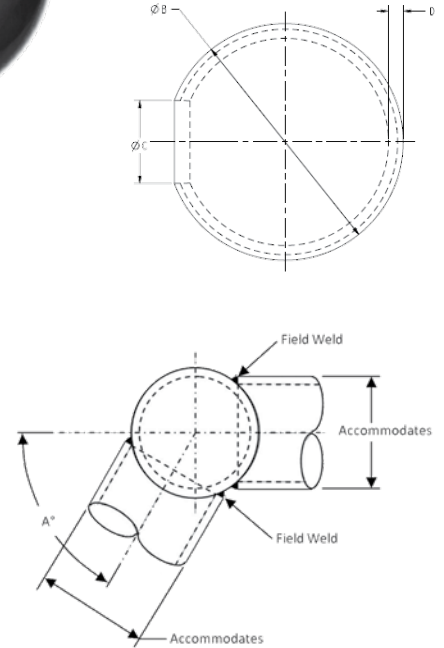

NOTES:

1. Dimensions in brackets [] are in millimeters.

Type STS-A-NCG, Single Piece

Terminal Pad Cap; EHV

Bolted 1-piece terminal pad cap of cast Aluminum; Stainless Steel Hardware.

Material: Aluminum Alloy

EHV Rated: Self Shielding at operating voltages up to 500 kV

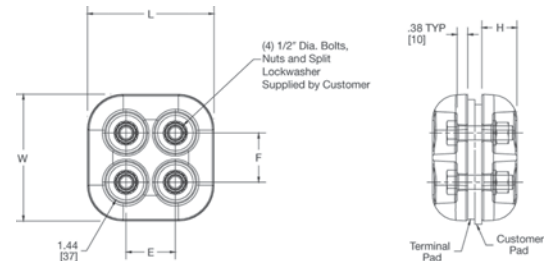

Catalog Number	E	F	H	L	W	Maximum Shielded Area
STS44ACG10	1.75 [44]	1.75 [44]	1.50 [38]	4.00 [102]	4.00 [102]	3.5 x 3.5
STS44A4NCG2	1.75 [44]	1.75 [44]	1.25 [32]	4.50 [114]	4.50 [114]	4 x 4
STS46A6NCG1	1.75 [44]	1.75 [44]	1.25 [32]	4.50 [114]	6.50 [165]	6 x 4

NOTES:

- Dimensions in brackets [] are in millimeters.
- Catalog number is for one shielding cap only. If more than one is required, specify total quantity.

End Plug, Type WLB-A

Bus to End Cap;

used with shielded bus support/expansion couplers

Material: Cast 356 Aluminum Alloy

EHV Rated: up to 550 kV
when used with shielded bus and
expansion connectors

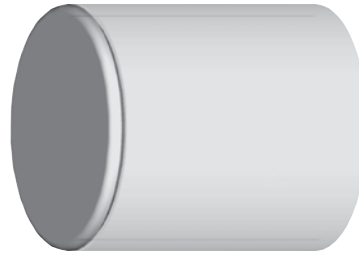

Catalog Number		O.D.	Conductor Aluminum Tubing Size
Sch. 40	Sch. 80		
WLB15A	—	1.32 [34]	1"
WLB16A	—	1.66 [42]	1-1/4"
WLB17A	—	1.90 [48]	1-1/2"
WLB18A	WLB58A	2.38 [60]	2"
WLB19A	WLB59A	2.88 [73]	2-1/2"
WLB20A	WLB90A	3.50 [89]	3"
WLB21A	—	4.00 [102]	3-1/2"
WLB22A	WLB92A	4.50 [114]	4"
WLB24A	—	5.56 [141]	5"

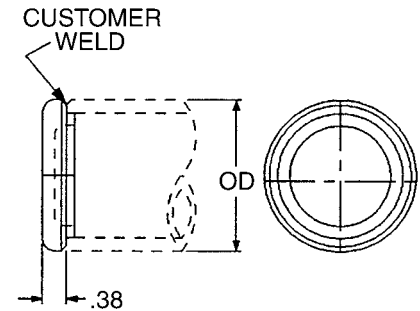

NOTES:

1. Dimensions in brackets [] are in millimeters.
2. Conductor smaller than 3 inch bus size not recommended for 550 kV.

Corona Bell, Type SCB-A

Bus to Corona Bell

Material: Aluminum Alloy

EHV Rated: Self Shielding up to 550 kV

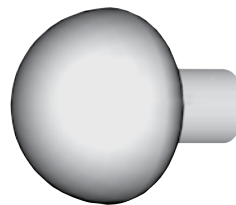

Catalog Number	Accommodates 'A' Dia. Aluminum Tube
SCB22A	4" (4.500 Dia.)
SCB24A	5" (5.563 Dia.)

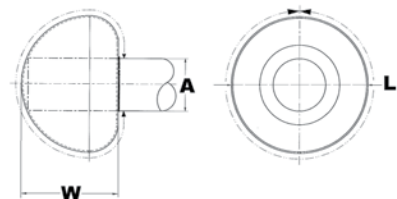

NOTES:

1. For bolted design contact factory.
2. Dimensions in brackets [] are in millimeters.
3. Conductor smaller than 3 inch bus size not recommended for 550 kV.

Table of Contents

Installation Tools Introduction..... N-4
 Tool Center N-4
 Limited Warranty N-4
 Repair Policy N-4
 Return Procedure..... N-4

Important Notes N-5
 Battery Tool Accessories N-5

T3 Technology Battery Crimpers
 PAT444ST3, 11 Ton, Dieless C-Head, T3 Technology..... N-7
 PAT750T3, 12 Ton, C-Head, T3 Technology..... N-8
 PAT46T3, 15 Ton, C-Head, T3 Technology..... N-9
 PAT46T3, 15 Ton, Latch Head, T3 Technology..... N-10

Battery Combo Kits
 PATRIOT® Combo Kits, T3 Technology N-11
 Specialty Pro Packs, Crimper & Impact Wrench..... N-12

Battery Crimpers
 PAT46LWS, 15 Ton, C-Head..... N-13
 PAT46LW, 15 Ton, Latch Head..... N-14
 PAT750, 12 Ton, C-Head..... N-15
 PAT444S, 11 Ton, C-Head, Dieless..... N-16
 PAT644, 11 Ton, Latch Head, Dieless..... N-17
 PAT81K2, 6 Ton, Latch Head, Dieless..... N-18
 PAT4PC834, 6 Ton, C-Head, Dieless..... N-19
 PAT600, 6 Ton, Latch Head..... N-20
 PAT500SJ, 6 Ton, Pistol Style, Scissor Action..... N-21
 PATMD-LW, 6 Ton, IN-LINE®, Scissor Action..... N-22

Hand Operated Crimpers
 Y750HSXT, 12 Ton, C-Head..... N-23
 Y35, 12 Ton, C-Head..... N-24
 Y644HSXT, 11 Ton, Latch Head, Dieless..... N-25
 Y81K2, 6 Ton, Latch Head, Dieless..... N-26
 Y4PC834, 6 Ton, C-Head, Dieless..... N-27
 Y500CTHS, 6 Ton, Latch Head..... N-28

Remote Operated Crimpers
 Y60LW, 60 Ton, Latch Head..... N-29
 Y46LWSBH, 15 Ton, C-Head..... N-30
 Y46LWBH, 15 Ton, Latch Head..... N-31
 Y45, 15 Ton, C-Head..... N-32
 Y750BHXT, 12 Ton, C-Head..... N-33
 Y35BH, 12 Ton, C-Head..... N-34
 Y444SBH, 11 Ton, C-Head, Dieless..... N-35
 Y81K2MBH, 6 Ton, Latch Head, Dieless..... N-36
 Y4PC834MBH, 6 Ton, C-Head, Dieless..... N-37
 Y34BH, 9 Ton, C-Head..... N-38
 Y29BH, 4.5 Ton, C-Head..... N-39



Battery Crimpers



Hand Operated Crimpers



Remote Powered Crimpers



Plier Hand Tool



Ferrule Installation Tools

Most frequently ordered catalog numbers are highlighted in BLUE

Table of Contents

Plier Hand Tools

Y10D, Nylon/Bare, #22-10 AWG..... N-40

Ferrule Installation Tools

YF2210FL, Front Load, Dieless, Insulated/Bare #22-10 AWG..... N-41
 YF268CFSL, Front & Side Load, Ratchet, #26-8 AWG..... N-41
 YF261CSKIT, Side Load, Ratchet, #26-1/0 AWG..... N-42

Mechanical Tools

Y8MRB1, Hand-held Ratchet, #22-8 AWG..... N-43
 MR8, Fully Protected Ratchet Mechanism for Critical Applications..... N-44
 MRE1022 Series, Ratchet, #22-10 AWG, Nylon/Vinyl and Bare..... N-45
 MR Series, Ratchet, #22-10 AWG, Nylon, Vinyl, Bare..... N-46
 MR4, Ratchet, #9-4 AWG, Bare..... N-47
 Y1MRTC, Rotating Die, Ratchet, #8-1 AWG Copper / #14-4 Thin Wall C-Taps..... N-48
 Y122CMR, Ratchet, #12-2 Stranded, Solid, Flex..... N-49
 Y122CMRKIT, Ratchet Tool with select long barrel connectors..... N-50
 Y122CMRCIKIT, Ratchet Tool with select standard barrel connectors..... N-50
 M8ND, #26-8 AWG..... N-51
 MRC840 Series, #8-4/0 AWG..... N-52
 MY28 and MY29 Series, Dieless, #8 Str.-250 kcmil CU; #8-4/0 Str. AL..... N-53
 OH25, Dieless Ratchet, #10-1/0 Str..... N-54
 OUR840, Ratchet, Overhead/Underground Applications..... N-55
 MD6 Series, #14 AWG-500 kcmil..... N-56
 MD7 Series, #14 AWG-500 kcmil..... N-57
 MD7 Ratchet Series..... N-58

Pneumatic Press

OEM840NCP, #8-4/0 AWG..... N-59
 OEM175TFM, #22-10 AWG..... N-60

Die Profiles..... N-61

60 Ton HPS/Fargo-Equivalent Dies

CD Index, Circumferential Profile..... N-62
 SH and AH Index, Hexagonal Profile..... N-66

12 Ton U Dies

For 35 and 750 Tool Series; 46 Series with PUADP1 Adapter..... N-68
 12 Ton U Die Kits: Copper, Aluminum, HYGROUND®..... N-69
 UM-Style, For OEM840NCP up to 4/0, 35 and 750 Series;
 46 Series with PUADP1 Adapter..... N-70

W Dies

For MD/PATMD, 500, and 600 Series..... N-71
 W Die Kits: Copper, Aluminum..... N-72

Battery Cutters

PATCUT4, 11 Ton, Scissor Action..... N-73
 PATCUT2156, 10 Ton, Latch Head..... N-74
 PATCUT129, 7 Ton, Latch Head..... N-75
 PATCUT245, 6 Ton, Latch Head..... N-76
 PAT500SJ CUT, 6 Ton, Scissor Action..... N-77
 PATMDCUTLW, 6 Ton, Scissor Action..... N-78
 PATMD-LW ACSR Kits, 6 Ton, Scissor Action..... N-79
 PATMD-LW CU/AL Kits, 6 Ton, Scissor Action..... N-80
 PATMD-LW GUY Kits, 6 Ton, Scissor Action..... N-81
 PATMDCUT82ALLIF, 6 Ton, Scissor Action, Long Reach, Live Line,
 Hot Stick, Angled Head..... N-82
 PATCUT1500, Copper/Aluminum Cable Cutter..... N-83



Mechanical Installation Tools



Die Sets



Battery Cutters

Most frequently ordered catalog numbers are highlighted in BLUE

Table of Contents

Hand-Operated Cutters
 YCUT129ACSR, Latch Head N-84

Remote Operated Cutters
 RHCC4CUAL, Scissor Action N-85
 RHCC2156ACSR, Latch Head N-86
 RHCC129ACSR, Latch Head N-87
 RHCC245CUAL, Latch Head N-88

Manual Cable Cutters
 MCC Series, Copper/Aluminum Cable Cutters N-89
 RCC Cu/Al Series, Ratchet Cable Cutters N-90
 RCC Cu/Al/ACSR Series, Ratchet Cable Cutters N-91
 RWRC Series, Ratchet Wire Rope Cutters N-92

Electric Pumps
 Y10AC9, Electric, 10,000 PSI, Light Weight N-93
 EPP10, Electric, 10,000 PSI, Light Weight N-94
 EP10, Electric, 10,000 PSI, Dual Voltage/Hertz N-95
 EPAC10, Electric, 10,000 PSI, Large 8 Quart Reservoir, Roll Cage N-96

Manual Pumps
 HP10, Manual, Hand, 10,000 PSI N-97
 FP10, Manual, Foot, 10,000 PSI N-97
 FP6, Manual, Foot, 6,000 PSI N-97

Gas Pumps
 GP10, Gasoline, 10,000 PSI, 4 Horse Power Engine N-98

Non-Conductive Hydraulic Hoses, 10,000 and 6,000 PSI N-99

Conductive Hydraulic Hoses, 10,000 and 8,800 PSI N-100

Pump/Hose Accessories N-101

MD6/MD7 Related Accessories N-102

12 and 15 Ton Related Accessories N-104

Force Test Gauges N-105

WIREMIKE™ Wire Micrometers N-106

BTW Series Micro-Adjustable Professional Grade Torque Wrenches N-107

WEJTAP™ Tooling and Accessories N-108

DOMINATOR Auger Bits for Treated Wood N-111

Hydraulic Impact Wrenches
 HIW-ENF Variable Torque, 7/16" Quick Chuck N-112
 HIW-MAG Machined Aluminum Gerotor Design N-113

Low Pressure Hydraulic Crimper
 KOMPRESSOR™ 12 Ton Remote Operation N-114

Low Pressure Hydraulic Tool Accessories N-115



Remote Cutter



Electric Pump



Force Test Gauge



Wire Micrometer



WEJTAP™ Tooling and Boosters



Hydraulic Impact Wrench

Most frequently ordered catalog numbers are highlighted in BLUE

Installation Tools

The BURNDY® Engineered System features the most complete line of installation tools in the electrical industry. Available in various styles: battery actuated, mechanical, full cycle ratchet, self contained hydraulic, remote controlled hydraulic, along with power actuated pumps, hoses and accessories. BURNDY has the options to suit your needs. BURNDY tools are designed to integrate with the complete line of BURNDY connectors. Whether you are a small contractor working with #22 wire or a large utility working with 2500 kcmil conductor, there is a BURNDY tool available to do the job.

The benefits of the BURNDY® Engineered System are many, the most significant benefit being reliability. There is nothing more important to the electrical industry today than reliability. It represents the one area that leads to economical installations that will endure for the life of the installation.

Tool Center

An important element of the BURNDY® Engineered System is the BURNDY Tool Center, located at 150 Burndy Road, Littleton, NH 03561, (800-426-8720 or 603-621-4499). This center provides advice and information on the operation, maintenance and repair of BURNDY tools. The repair center is staffed with specialized technicians who provide the best possible service for all BURNDY tools, pumps and accessories.

BURNDY designed and produced the first self contained hydraulic compression electrical connector installation tool in 1934. In our continuing efforts to provide the highest quality and highest value connection systems, we offer the current BURNDY tool policy.

Limited Warranty

The majority of BURNDY tools are warranted to be free of defects in materials and workmanship for a period of five (5) years from the date of shipment. See specific tool page for length of warranty. If inspection by a certified technician shows the trouble is caused by defective workmanship or material, BURNDY will repair or (at our option) replace the tool.

This Warranty does not apply where:

- Repairs or alterations have been made or attempted by others
- Repairs are required because of normal wear and tear
- The tool has been abused, misused or improperly maintained
- The use of any non-BURNDY product has resulted in damage to the tool

Return Procedure

All tools sent to the BURNDY Tool Center (1-800-426-8720) or an authorized repair center must be accompanied by a purchase order with detailed bill to and ship to address authorizing repair. Requests for repair charges before work is done must be stated on the purchase order. All tools sent to the BURNDY Tool Center or an authorized repair center as a warranty claim must be accompanied by a proof of purchase such as a BURNDY invoice or invoice from any BURNDY distributor.

All tools must be shipped at the owner's expense, prepaid. BURNDY pays for the return freight, same surface freight as received. Airfreight returns will be returned same way collect for non-warranty repair and prepaid for warranty repairs.

This warranty and repair policy supercedes all previous policies and is in effect as of January 1, 2010.

Repair Policy

All non-warranty repaired tools are completely reconditioned and receive a limited 1-year warranty. Non-warranty repair returns tools to like-new condition at a maximum cost of 40% of a new tool. A nominal service charge of \$5 is applied to all repairs to cover shop supplies, oil disposal and other miscellaneous services not covered as part of the standard repair.

If the decision is made not to repair, a handling charge of \$25.00 will be applied plus return freight costs.

IMPORTANT NOTES:

Unless noted, product is not recommended for use on energized lines.

Notes for battery operated crimpers and cutters:

It is recommended that battery be removed when changing jaws, changing dies or storing tool in case.

Weights reflect “without battery”, bare tool only.

Select battery operated tools are available in alternate versions :

- AC
- DC
- 250 Volt

Contact Customer Service for further information:

US: 1-800-346-4175

Canada: 1-800-465-7051

International: 1-603-647-5299

Battery Tool Accessories:

BAT18VLI: 3.0Ah Li-Ion battery
BAT18V5AHLI: 5.0Ah Li-Ion battery
PATCHGRLI: 120V-AC Charger
PATCHGRLIDC: 12/24V-DC Charger

PT208620: Lanyard
PT10074020: Wrist Strap for PATMD-LW

W28K (6-ton): Cutter die, 4-4/0 CU/AL, ACSR
WDA8300 (6-ton): Range taking die, 4-500 CU Str. and #2-4/0 CU Flex
WDC4500 (6 ton): Range taking die, #8-300 AL, #6-400 CU Str, and #2-4/0 CU Flex

P15K (15-ton): Cutter die, max. diameter 1.2”
PUADP1 (15-ton): U-die Adapter

PATCASELI: Polymer Carry Case
PATPROBAG: Nylon Pro Bag
TOOLBAGMDLI: Vinyl Utility Bag (for IN-LINE® tool)



PATRIOT® SERIES with EP★ENHANCED POWER

BURNDY® PATRIOT® Tools are designed to accept an expanded range of Makita 18V Lithium-Ion Batteries, identified by Makita Star Power. Multi-Ah Capability provides the user with more choices and flexibility than ever before. Accepts large capacity 6Ah to smaller capacity 2Ah batteries.

More **POWER**, More **FLEXIBILITY**, More **PRODUCTIVITY**

PLEASE NOTE:

Prior models, tools **WITHOUT** the EP Enhanced Power mark, will only accept Makita 18V **3.0Ah** batteries.

Do not force any other size battery into the tool.

Damage caused by doing so will void the warranty.

THE NEW PATRIOT®



TRACK | TRACE | TRANSMIT

T3 TECHNOLOGY WITH ONBOARD GPS

Record when and where crimps occur, unassisted by external devices.

- Onboard GPS maps crimp locations
- Bluetooth® enabled for instant crimp data
- Remotely observe project status
- Output force validation, green/red LED
- Flag & enter comments/photos for individual crimps
- Manage BURNDY® T3 tool inventory
- Link accounts and securely share tools
- Sync and upload data to the cloud
- Create custom reports for projects



TRACK:
Map location
of crimps



TRACE: Flag
individual crimps with
comments/photos



TRANSMIT:
Sync data
to the cloud

All of the exceptional features of its PATRIOT predecessor, plus a new ergonomic design and state of the art technology.



1-800-451-4956 | www.burndyT3.com

**PATRIOT® 11 Ton with T3 Technology
TRACK TRACE TRANSMIT**

Tool Series: PAT444ST3

- **TRACK** crimp locations with onboard GPS - **BURNDY Exclusive!**
- **TRACE** individual crimps with comments, photos, and output force validation
- **TRANSMIT** via Bluetooth® technology and sync data to the cloud
- C-Head style for easy access and increased flexibility
- Dieless System with range taking capability
- 355° Head rotation
- Bright LED Worklight and Red/Green LED to validate output force
- Improved ergonomic design with more balance and better grip to reduce user fatigue

For Use On:

Copper #4 - 1000 kcmil Code & Flex

Terminals: YA-L, YA-2LN, YA, YA-2N,
YA-L-2TC, YAB-4N, YA-L-TC, YA-2L,
YA-4N, YAV, YA-L-FX, YA-FXB, YAG

Splices: YS-L, YS, YS-T

Copper #4 - 1000 kcmil Code; #2 - 777 kcmil Flex

HYPLUG™: YE-P, YE-P-FX, YEV-P-FX

Aluminum #4 AWG - 1000 kcmil

Terminals: YA-A, YA-A-TN

Splices: YS-A

HYPLUG™: AYP, AYPO

ACSR, AAC, AAAC, ACAR #4 AWG - 556.5 kcmil

Splices: YDS-RL, YDS-RLNI

Cable Pulling Heads #6 AWG - 1000 kcmil copper & aluminum

Type: YCP-L



Models:

PAT444ST3U03A2 with 3.0Ah Li-Ion batteries, hard case
PAT444ST3U05A2 with 5.0Ah Li-Ion batteries, hard case

PAT444ST3U03A3 with 3.0Ah Li-Ion batteries, pro bag
PAT444ST3U05A3 with 5.0Ah Li-Ion batteries, pro bag

Specifications:

Output Force:	11 Tons	
Tool Weight:	15.20 lbs (without battery)	
Size:	16.90" x 14.95" x 3.25"	Unique Crimp Embossment
Die Style:	Dieless	
Operating Voltage:	18 V-DC Lithium-Ion (Accepts 2.0Ah-6.0Ah Makita)	
Recharge Time:	30 minutes (3.0Ah)	
	45 minutes (5.0Ah)	
Warranty:	5 year limited warranty	
	Lifetime warranty on INFINITY DRIVE®	
	3 year on batteries and charger	
Kits Include:	2 batteries, charger, lanyard, and carrying case	

Connections are UL Listed to UL 486A-486B on BURNDY® Copper and Aluminum Terminals and Splices



Complies with ANSI C119.4 on YDS-RL and YDS-RLNI Splices (ACSR, AAC, AAAC, ACAR)



Qualified for use on YCP-L Compression Pulling Heads

Accessories:

BAT18VLI:	3.0Ah Li-Ion battery
BAT18V5AHLI:	5.0Ah Li-Ion battery
PATCHGRLI:	120V-AC Charger
PATCHGRLIDC:	12/24V-DC Charger
PT208620:	Lanyard
FORCEGAUGE11:	Force Test Gauge
PATPROBAG:	Nylon Pro Bag

See Important Notes page at start of Section.

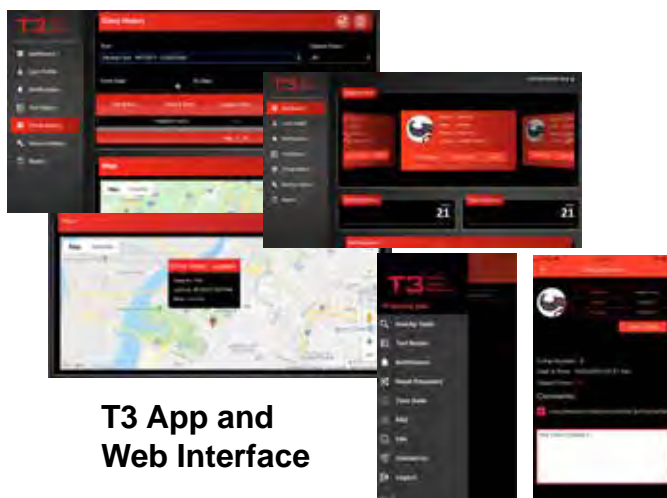

T3 App and Web Interface

PATRIOT® 12 Ton with T3 Technology TRACK TRACE TRANSMIT

Tool Series: PAT750T3

- **TRACK** crimp locations with onboard GPS - **BURNDY Exclusive!**
- **TRACE** individual crimps with comments and output force validation
- **TRANSMIT** via Bluetooth® technology and sync data to the cloud
- C-head with 1.65" jaw opening and 355° head rotation
- Used with U dies
- Patented T-Track alignment guide for HYGROUND® as well as other asymmetrical connectors
- Bright LED Worklight and Red/Green LED to validate output force
- Improved ergonomic design with more balance and better grip to reduce user fatigue

For Use On:

Tension Sleeves

Copper	#8 sol. - 500 kcmil
Aluminum	#8 sol. - 587.2 kcmil
ACSR	#4 - 556.5 kcmil

Taps

Copper	#14 sol. - 500 kcmil
Aluminum	#8 - 500 kcmil

Aerial Cable

Copper	#6 - 500 kcmil
--------	----------------

Terminals & Splices

Copper	#8 - 750 kcmil
Aluminum	#8 - 750 kcmil
ACSR	#4 - 556.5 kcmil

HYGROUND® (Compression Grounding)

Copper	#8 - 500 kcmil
Ground Rods	1/2" - 1" diameter



Models:

PAT750T3U03A2	with 3.0Ah Li-Ion batteries, hard case
PAT750T3C03A2	with rubber covered head (3.0Ah), hard case
PAT750T3U05A2	with 5.0Ah Li-Ion batteries, hard case
PAT750T3C05A2	with rubber covered head (5.0Ah), hard case

PAT750T3U03A3	with 3.0Ah Li-Ion batteries, pro bag
PAT750T3C03A3	with rubber covered head (3.0Ah), pro bag
PAT750T3U05A3	with 5.0Ah Li-Ion batteries, pro bag
PAT750T3C05A3	with rubber covered head (5.0Ah), pro bag

Specifications:

Output Force:	12 Tons
Tool Weight:	14.85 lbs (without battery)
Size:	15.75" x 14.75" x 3.25"
Die Style:	U style
Jaw Opening:	1.65"
Operating Voltage:	18 V-DC Lithium-Ion (Accepts 2.0Ah-6.0Ah Makita)
Recharge Time:	30 minutes (3.0Ah) 45 minutes (5.0Ah)
Warranty:	5 year limited warranty Lifetime warranty on INFINITY DRIVE® 3 year on batteries and charger
Kits Include:	2 batteries, charger, lanyard, and carrying case

Accessories:

BAT18VLI:	3.0Ah Li-Ion battery
BAT18V5AHLI:	5.0Ah Li-Ion battery
PATCHGRLI:	120V-AC Charger
PATCHGRLIDC:	12/24V-DC Charger
PT208620:	Lanyard
FORCEGAUGE1215:	Force Test Gauge
PATPROBAG:	Nylon Pro Bag

See Important Notes page at start of Section.

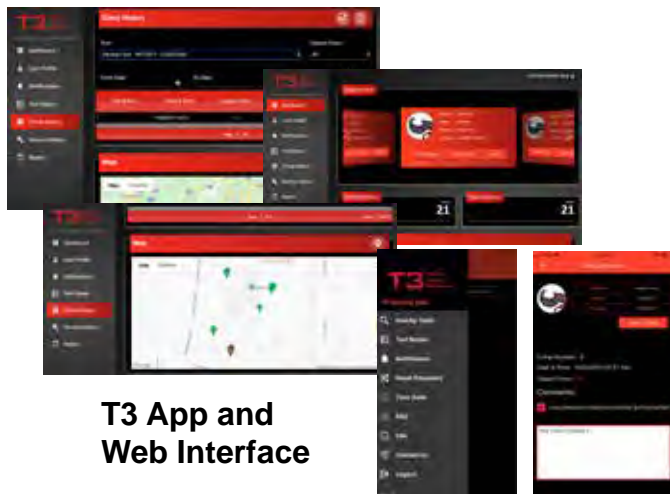

T3 App and
Web Interface

**PATRIOT® 15 Ton with T3 Technology
TRACK TRACE TRANSMIT**

Tool Series: PAT46T3 C-Head

- **TRACK** crimp locations with onboard GPS - **BURNDY Exclusive!**
- **TRACE** individual crimps with comments, photos, and output force validation
- **TRANSMIT** via Bluetooth® technology and sync data to the cloud
- C-head with 2.00" jaw opening and 355° head rotation
- Used with P dies; U dies with PUADP1 Adapter (sold separately)
- Bright LED Worklight and Red/Green LED to validate output force
- Improved ergonomic design with more balance and better grip to reduce user fatigue

For Use On:

Copper - #8 AWG Str. - 1500 kcmil: Code Cable, Navy Cable, Flexible, Extra Flexible, 1/2" - 1" Ground Rods

Terminals, grounding:
to 500 kcmil; YGA, YGHA, YGF

Terminals, uninsulated:
#8 - 1500 kcmil; YA, YA-2N, YA-L, YA-LB, YA-TC, YA-2LN, YAB-4N, YAV-L, YAV-RS, YA-TC-FX

Terminals, insulated:
#8 - 2/0 AWG; YAEV-L, YAEV-H, YAEV-RS, YAEV-RH

Splices:
#8 - 1500 kcmil; YS, YS-T, YS-L, YS-LB, YST, YSP-T, YGS, YGHS

Taps:
#14 - 1000 kcmil; YH, YCHC
to 4/0 AWG; YC-C

Taps, grounding:
to 500 kcmil; YGHC-C, YGHP-C, YGHR-C

Aluminum - #8 AWG - 1250 kcmil Code Cables

Terminals: YA-A, AYP, AYPO

Splices: YS-A, YS-AT, YRB

Taps: YFD, YFN, YFO, YFR

ACSR - see Overhead Transmission & Distribution Sections H & I of the current BURNDY® Master Catalog



Models:

- | | |
|---------------|---|
| PAT46T3SU03A2 | with 3.0Ah Li-Ion batteries, hard case |
| PAT46T3SU05A2 | with 5.0Ah Li-Ion batteries, hard case |
| PAT46T3SC03A2 | with rubber covered head (3.0Ah), hard case |
| PAT46T3SC05A2 | with rubber covered head (5.0Ah), hard case |
| PAT46T3SU03A3 | with 3.0Ah Li-Ion batteries, pro bag |
| PAT46T3SU05A3 | with 5.0Ah Li-Ion batteries, pro bag |
| PAT46T3SC03A3 | with rubber covered head (3.0Ah), pro bag |
| PAT46T3SC05A3 | with rubber covered head (5.0Ah), pro bag |

Specifications:

Output Force:	15 Tons
Tool Weight:	18.15 lbs (without battery)
Size:	18.44" x 14.13" x 3.26"
Die Style:	P and U dies (with PUADP1)
Operating Voltage:	18 V-DC Lithium-Ion (Accepts 2.0Ah-6.0Ah Makita)
Jaw Opening:	2.00"
Recharge Time:	30 minutes (3.0Ah) 45 minutes (5.0Ah)
Warranty:	5 year limited warranty Lifetime warranty on INFINITY DRIVE® 3 year on batteries and charger
Kits Include:	2 batteries, charger, lanyard, and carrying case

Accessories:

- | | |
|-----------------|----------------------|
| BAT18VLI: | 3.0Ah Li-Ion battery |
| BAT18V5AHLI: | 5.0Ah Li-Ion battery |
| PATCHGRLL: | 120V-AC Charger |
| PATCHGRLLDC: | 12/24V-DC Charger |
| PT208620: | Lanyard |
| FORCEGAUGE1215: | Force Test Gauge |
| PATPROBAG: | Nylon Pro Bag |

See Important Notes page at start of Section.

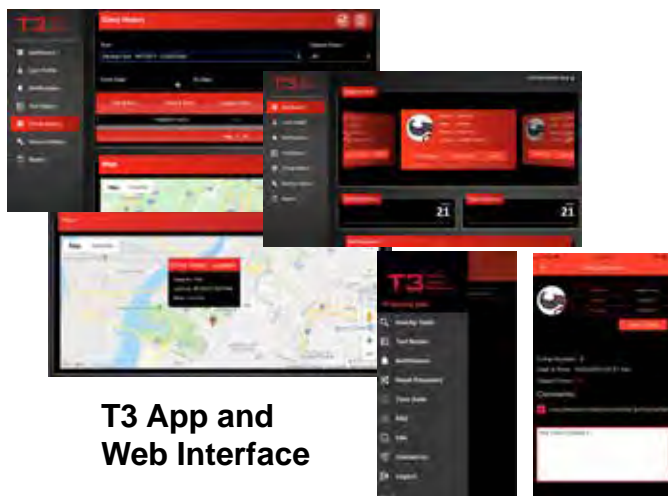

**T3 App and
Web Interface**

PATRIOT® 15 Ton with T3 Technology TRACK TRACE TRANSMIT

Tool Series: PAT46T3 Latch Head

- **TRACK** crimp locations with onboard GPS - **BURNDY Exclusive!**
- **TRACE** individual crimps with comments, photos, and output force validation
- **TRANSMIT** via Bluetooth® technology and sync data to the cloud
- Latch head with 2.00" ram travel and 355° head rotation
- Used with P dies; U dies with PUADP1 Adapter (sold separately)
- Bright LED Worklight and Red/Green LED to validate output force
- Improved ergonomic design with more balance and better grip to reduce user fatigue

For Use On:

Copper - #8 AWG Str. - 1500 kcmil: Code Cable, Navy Cable, Flexible, Extra Flexible, 1/2" - 1" Ground Rods

Terminals, grounding:

to 500 kcmil; YGA, YGHA, YGF

Terminals, uninsulated:

#8 - 1500 kcmil: YA, YA-2N, YA-L, YA-LB, YA-TC, YA-2LN, YAB-4N, YAV-L, YAV-RS, YA-TC-FX

Terminals, insulated:

#8 - 2/0 AWG; YAEV-L, YAEV-H, YAEV-RS, YAEV-RH

Splices:

#8 - 1500 kcmil: YS, YS-T, YS-L, YS-LB, YST, YSP-T, YGS, YGHS

Taps:

#14 - 1000 kcmil: YH, YCHC
to 4/0 AWG; YC-C

Taps, grounding:

to 500 kcmil; YGHC-C, YGHP-C, YGHR-C

Aluminum - #8 AWG - 1250 kcmil Code Cables

Terminals: YA-A, AYP, AYPO

Splices: YS-A, YS-AT, YRB

Taps: YFD, YFN, YFO, YFR

ACSR - see Overhead Transmission & Distribution Sections H & I
of the current BURNDY® Master Catalog



Models:

PAT46T3LU03A2

with 3.0Ah Li-Ion batteries, hard case

PAT46T3LU05A2

with 5.0Ah Li-Ion batteries, hard case

PAT46T3LU03A3

with 3.0Ah Li-Ion batteries, pro bag

PAT46T3LU05A3

with 5.0Ah Li-Ion batteries, pro bag

Specifications:

Output Force:	15 Tons
Tool Weight:	16.00 lbs (without battery)
Size:	18.59" x 15.18" x 3.26"
Die Style:	P and U dies (with PUADP1)
Ram Travel:	2.00"
Operating Voltage:	18 V-DC Lithium-Ion (Accepts 2.0Ah-6.0Ah Makita)
Recharge Time:	30 minutes (3.0Ah) 45 minutes (5.0Ah)
Warranty:	5 year limited warranty Lifetime warranty on INFINITY DRIVE® 3 year on batteries and charger
Kits Include:	2 batteries, charger, lanyard, and carrying case

Accessories:

BAT18VLI:	3.0Ah Li-Ion battery
BAT18V5AHLI:	5.0Ah Li-Ion battery
PATCHGRLI:	120V-AC Charger
PATCHGRLIDC:	12/24V-DC Charger
PT208620:	Lanyard
FORCEGAUGE1215:	Force Test Gauge
PATPROBAG:	Nylon Pro Bag

See Important Notes page at start of Section.

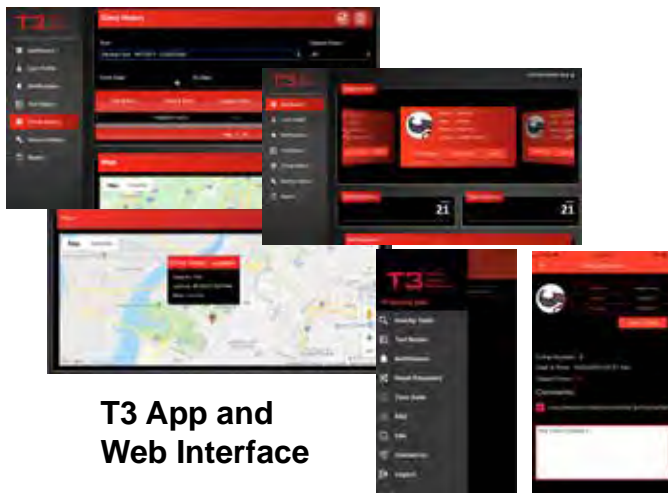

**T3 App and
Web Interface**

Crimping & Cutting Together

An Exceptional Value:

Get the most popular BURNDY® tools in four convenient combinations.

- Broad range of crimping and cutting capability; two tools to get the job done right!
- Robust hard case, custom foam and 4 secure latches, protect your investment.
- Tooling Solutions to increase productivity.
- BURNDY® Tools + BURNDY® Connectors = The BURNDY® Engineered System.



Saves you hundreds of dollars!

Catalog Number	Description (All battery tools accept 2Ah-6Ah Makita Lithium-ion batteries)
PATRIOTKIT1	Kit Includes: PAT750 12-Ton C-Head Crimper, PATCUT1500 CU/AL Ratchet Cutter, (2) 3.0Ah 18V Li-ion Batteries, 120V-AC Charger, (2) Lanyards, Heavy Duty Hard Case
PATRIOTKIT2	Kit Includes: PAT444S 11-Ton Dieless C-Head Crimper, PATCUT1500 CU/AL Ratchet Cutter, (2) 3.0Ah 18V Li-ion Batteries, 120V-AC Charger, (2) Lanyards, Heavy Duty Hard Case
PATRIOTKIT3	Kit Includes: PAT81K2 6-Ton 4-POINT® Dieless Latch Head Crimper, PATCUT1500 CU/AL Ratchet Cutter, (2) 3.0Ah 18V Li-ion Batteries, 120V-AC Charger, (2) Lanyards, Heavy Duty Hard Case
PATRIOTKIT4	Kit Includes: PAT750 12-Ton C-Head Crimper, U-Die Kit for Copper (UDIEKITCU), PATCUT1500 CU/AL Ratchet Cutter, (2) 3.0Ah 18V Li-ion Batteries, 120V-AC Charger, (2) Lanyards, Heavy Duty Hard Case

Note: View individual catalog pages for crimper and cutter specifications.



Specialty PRO PACKS

Select PATRIOT® Crimpers with Makita® Impact Wrenches

* Each Pro Pack comes complete with
 (1) BURNDY® PATRIOT® Crimper,
 (1) Makita® Impact Wrench,
 (2) 3Ah or 5Ah 18V Li-ion batteries,
 120V-AC Charger and Lanyard,
 packaged in the durable Nylon Pro Bag

3Ah Catalog Number	Description *	5Ah Catalog Number
PATMD10003AA	6-Ton IN-LINE® Tool with BG/D3 & Makita XDT14Z 1/4" Hex Impact Driver	PATMD10005AA
PATMD10003AB	6-Ton IN-LINE® Tool with BG/D3 & Makita XWT15Z 1/2" Square Drive Impact Wrench	PATMD10005AB
PATMD10003AC	6-Ton IN-LINE® Tool with BG/D3 & Makita XWT09XVZ 7/16" Hex Impact Wrench	PATMD10005AC
PATMD20003AA	6-Ton IN-LINE® Tool with D3 Snub-nose & Makita XDT14Z 1/4" Hex Impact Driver	PATMD20005AA
PATMD20003AB	6-Ton IN-LINE® Tool with D3 Snub-nose & Makita XWT15Z 1/2" Square Drive Impact Wrench	PATMD20005AB
PATMD20003AC	6-Ton IN-LINE® Tool with D3 Snub-nose & Makita XWT09XVZ 7/16" Hex Impact Wrench	PATMD20005AC
PATMD30003AA	6-Ton IN-LINE® Tool with O/D3 & Makita XDT14Z 1/4" Hex Impact Driver	PATMD30005AA
PATMD30003AB	6-Ton IN-LINE® Tool with O/D3 & Makita XWT15Z 1/2" Square Drive Impact Wrench	PATMD30005AB
PATMD30003AC	6-Ton IN-LINE® Tool with O/D3 & Makita XWT09XVZ 7/16" Hex Impact Wrench	PATMD30005AC
PAT444SU03AA	11-Ton Dieless C-Head Crimper & Makita XDT14Z 1/4" Hex Impact Driver	PAT444SU05AA
PAT444SU03AB	11-Ton Dieless C-Head Crimper & Makita XWT15Z 1/2" Square Drive Impact Wrench	PAT444SU05AB
PAT444SU03AC	11-Ton Dieless C-Head Crimper & Makita XWT09XVZ 7/16" Hex Impact Wrench	PAT444SU05AC
PAT750U03AA	12-Ton C-Head Crimper & Makita XDT14Z 1/4" Hex Impact Driver	PAT750U05AA
PAT750U03AB	12-Ton C-Head Crimper & Makita XWT15Z 1/2" Square Drive Impact Wrench	PAT750U05AB
PAT750U03AC	12-Ton C-Head Crimper & Makita XWT09XVZ 7/16" Hex Impact Wrench	PAT750U05AC



Note: View individual catalog pages for crimper specifications.

See Important Notes page at start of Section.

PATRIOT® 15 Ton, C-Head
Hydraulic Self-Contained, 18V Lithium-Ion

Tool Series: PAT46LWS

- 2" jaw opening
- Used with P dies; U dies with PUADP1 adapter (sold separately)
- Light weight, scoop style C-head with 355° head rotation
- Overmolded, ergonomic handle
- Improved ergonomic balance
- Includes 2 batteries, charger, and case
- EP Enhanced Power — tools accept 2.0, 3.0, 4.0, 5.0, and 6.0Ah Makita batteries

For Use On:

Copper - #8 AWG Str. - 1500 kcmil

Code Cable, Navy Cable, Flexible, Extra Flexible
1/2" - 1" Ground Rods

Terminals, grounding:

to 500 kcmil; YGA, YGHA, YGF

Terminals, uninsulated:

#8 - 1500 kcmil: YA, YA-2N, YA-L, YA-LB, YA-TC, YA-2LN,
YAB-4N, YAV-L, YAV-RS, YA-TC-FX

Terminals, insulated:

#8 - 2/0 AWG; YAEV-L, YAEV-H, YAEV-RS, YAEV-RH

Splices:

#8 - 1500 kcmil: YS, YS-T, YS-L, YS-LB, YST, YSP-T,
YGS, YGHS

Taps:

#14 - 1000 kcmil: YH, YCHC
to 4/0 AWG; YC-C

Taps, grounding:

to 500 kcmil; YGHC-C, YGHP-C, YGHR-C

Aluminum - #8 AWG - 1250 kcmil

Code Cables

Terminals: YA-A, AYP, AYPO

Splices: YS-A, YS-AT, YRB

Taps: YFD, YFN, YFO, YFR

ACSR - see Overhead Transmission & Distribution Sections H & I
of the current BURNDY® Master Catalog



Models:

PAT46LWSLI
PAT46CLWSLI
PAT46LWSL5
PAT46CLWSL5

with 3.0Ah Li-Ion batteries, hard case
with rubber covered head (3.0Ah), hard case
with 5.0Ah Li-Ion batteries, hard case
with rubber covered head (5.0Ah), hard case

PAT46LWSLIPB
PAT46CLWSLIPB
PAT46LWSL5PB
PAT46CLWSL5PB

with 3.0Ah Li-Ion batteries, pro bag
with rubber covered head (3.0Ah), pro bag
with 5.0Ah Li-Ion batteries, pro bag
with rubber covered head (5.0Ah), pro bag

Specifications:

Output Force:	15 Tons
Tool Weight:	17.65 lbs (without battery)
Size:	18.00" x 14.00" x 3.00"
Die Style:	P and U (with PUADP1)
Jaw Opening:	2.00"
Operating Voltage:	18 V-DC Lithium-Ion
Recharge Time:	30 minutes (3.0Ah) 45 minutes (5.0Ah)
Warranty:	5 year limited warranty Lifetime warranty on INFINITY DRIVE® 3 year on batteries and charger

Accessories:

P15K:	Cutter Die, max. diameter 1.2"
PUADP1:	U Die Adapter
BAT18VLI:	3.0Ah Li-Ion battery
BAT18V5AHLI:	5.0Ah Li-Ion battery
PATCHGRLI:	120V-AC Charger
PATCHGRLIDC:	12/24V-DC Charger
PT208620:	Lanyard
FORCEGAUGE1215:	Force Test Gauge

See Important Notes page at start of Section.

PATRIOT® 15 Ton, Latch Head Hydraulic Self-Contained, 18V Lithium-Ion

Tool Series: PAT46LW

- 2" ram travel
- Used with P dies; U dies with PUADP1 adapter (sold separately)
- Light weight, Latch-head
- 355° head rotation
- Ergonomically balanced
- Includes 2 batteries, charger, and case
- EP Enhanced Power — tools accept 2.0, 3.0, 4.0, 5.0, and 6.0Ah Makita batteries



For Use On:

Copper - #8 AWG Str. - 1500 kcmil

Code Cable, Navy Cable, Flexible, Extra Flexible
1/2" - 1" Ground Rods

Terminals, grounding:

to 500 kcmil; YGA, YGHA, YGF

Terminals, uninsulated:

#8 - 1500 kcmil; YA, YA-2N, YA-L, YA-LB, YA-TC, YA-2LN,
YAB-4N, YAV-L, YAV-RS, YA-TC-FX

Terminals, insulated:

#8 - 2/0 AWG; YAEV-L, YAEV-H, YAEV-RS, YAEV-RH

Splices:

#8 - 1500 kcmil; YS, YS-T, YS-L, YS-LB, YST, YSP-T,
YGS, YGHS

Taps:

#14 - 1000 kcmil; YH, YCHC
to 4/0 AWG; YC-C

Taps, grounding:

to 500 kcmil; YGHC-C, YGHP-C, YGHR-C

Aluminum - #8 AWG - 1250 kcmil

Code Cables

Terminals: YA-A, AYP, AYPO

Splices: YS-A, YS-AT, YRB

Taps: YFD, YFN, YFO, YFR

ACSR - see Overhead Transmission & Distribution Sections H & I
of the current BURNDY® Master Catalog

Models:

PAT46LWLI	with 3.0Ah batteries, hard case
PAT46LWL5	with 5.0Ah batteries, hard case
PAT46LWLIPB	with 3.0Ah batteries, pro bag
PAT46LWL5PB	with 5.0Ah batteries, pro bag

Specifications:

Output Force:	15 Tons
Tool Weight:	15.50 lbs (without battery)
Size:	18.75" x 13.75" x 3.75"
Die Style:	P and U (with PUADP1)
Operating Voltage:	18 V-DC Lithium-Ion
Recharge Time:	30 minutes (3.0Ah) 45 minutes (5.0Ah)
Warranty:	5 year limited warranty Lifetime warranty on INFINITY DRIVE® 3 year on batteries and charger

Accessories:

P15K:	Cutter Die, max. diameter 1.2"
PUADP1:	U Die Adapter
BAT18VLI:	3.0Ah Li-Ion battery
BAT18V5AHLI:	5.0Ah Li-Ion battery
PATCHGRLI:	120V-AC Charger
PATCHGRLIDC:	12/24V-DC Charger
PT208620:	Lanyard
FORCEGAUGE1215:	Force Test Gauge

See Important Notes page at start of Section.

PATRIOT® 12 Ton, C-Head
Hydraulic Self-Contained, 18V Lithium-Ion

Tool Series: PAT750

- 1.65" jaw opening
- Used with U dies
- C-head with 355° head rotation
- Patented T-Track alignment guide for HYGROUND® as well as other asymmetrical connectors
- Includes 2 batteries, charger, and case
- EP Enhanced Power — tools accept 2.0, 3.0, 4.0, 5.0, and 6.0Ah Makita batteries

For Use On:

Tension Sleeves

Copper	#8 sol. - 500 kcmil
Aluminum	#8 sol. - 587.2 kcmil
ACSR	#4 - 556.5 kcmil

Taps

Copper	#14 sol. - 500 kcmil
Aluminum	#8 - 500 kcmil

Aerial Cable

Copper	#6 - 500 kcmil
--------	----------------

Terminals & Splices

Copper	#8 - 750 kcmil
Aluminum	#8 - 750 kcmil
ACSR	#4 - 556 kcmil

HYGROUND® (Compression Grounding)

Copper	#8 - 500 kcmil
Ground Rods	1/2" - 1" diameter



Models:

PAT750LI with 3.0Ah Li-Ion batteries, hard case
PAT750CLI with rubber covered head (3.0Ah), hard case
PAT750L5 with 5.0Ah Li-Ion batteries, hard case
PAT750CL5 with rubber covered head (5.0Ah), hard case

PAT750LIPB with 3.0Ah Li-Ion batteries, pro bag
PAT750CLIPB with rubber covered head (3.0Ah), pro bag
PAT750L5PB with 5.0Ah Li-Ion batteries, pro bag
PAT750CL5PB with rubber covered head (5.0Ah), pro bag

Specifications:

Output Force:	12 Tons
Tool Weight:	14.25 lbs (without battery)
Size:	15.75" x 13.50" x 3.50"
Die Style:	U
Jaw Opening:	1.65"
Operating Voltage:	18 V-DC Lithium-Ion
Recharge Time:	30 minutes (3.0Ah) 45 minutes (5.0Ah)
Warranty:	5 year limited warranty Lifetime warranty on INFINITY DRIVE® 3 year on batteries and charger

Accessories:

BAT18VLI:	3.0Ah Li-Ion battery
BAT18V5AHLI:	5.0Ah Li-Ion battery
PATCHGRLI:	120V-AC Charger
PATCHGRLLDC:	12/24V-DC Charger
PT208620:	Lanyard
FORCEGAUGE1215:	Force Test Gauge



Wide U-dies (sold separately) can be used with long barrel terminals and splices saving time and labor!

See Important Notes page at start of Section.

PATRIOT® 11 Ton, C-Head, Dieless Hydraulic Self-Contained, 18V Lithium-Ion

Tool Series: PAT444S

- New C-Head style for easy access and increased flexibility
- Dieless System with range taking capability
- 355° Head rotation
- Ergonomically balanced
- Includes 2 batteries, charger, and case
- EP Enhanced Power — tools accept 2.0, 3.0, 4.0, 5.0, and 6.0Ah Makita batteries

For Use On:

Copper #4 - 1000 kcmil Code & Flex

Terminals: YA-L, YA-2LN, YA, YA-2N, YA-L-2TC, YAB-4N,
YA-L-TC, YA-2L, YA-4N, YAV, YAZ, YA-L-FX, YA-FXB,
YBA, YAG

Splices: YS-L, YS, YS-T

Copper #4 - 1000 kcmil Code; #2 - 777 kcmil Flex

HYPLUG™: YE-P, YE-P-FX, YEV-P-FX

Aluminum #4 AWG - 1000 kcmil

Terminals: YA-A, YA-A-TN

Splices: YS-A

HYPLUG™: AYP, AYPO

ACSR, AAC, AAAC, ACAR #4 AWG - 556.5 kcmil

Splices: YDS-RL, YDS-RLNI

Cable Pulling Heads: YCP-L

#6 AWG - 1000 kcmil (copper & aluminum)

See Expanded Range details in Reference Section



Models:

PAT444SLI	with 3.0Ah Li-Ion batteries, hard case
PAT444SL5	with 5.0Ah Li-Ion batteries, hard case
PAT444SLIPB	with 3.0Ah Li-Ion batteries, pro bag
PAT444SL5PB	with 5.0Ah Li-Ion batteries, pro bag

Specifications:

Output Force:	11 Tons
Tool Weight:	14.80 lbs (without battery)
Size:	16.9" x 13.7" x 3.2"
Die Style:	Dieless
Operating Voltage:	18 V-DC Lithium-Ion
Recharge Time:	
3.0Ah	30 minutes
5.0Ah	45 minutes
Warranty:	5 year limited warranty
	Lifetime warranty on INFINITY DRIVE®
	3 years on batteries and charger

Accessories:

BAT18VLI:	Hi-capacity LI Makita battery (3.0Ah)
BAT18V5AHLI:	Hi-capacity LI Makita battery (5.0Ah)
PATCHGRLI:	120V-AC Makita charger
PATCHGRLIDC:	12/24V-DC Makita charger
PT208620:	Lanyard
FORCEGAUGE11:	Force Test Gauge



Unique 444S Crimp
Embossment

Connections are UL Listed to UL 486A-486B
on BURNDY® Copper and Aluminum Terminals and Splices



Complies with ANSI C119.4 on YDS-RL and YDS-RLNI Splices
(ACSR, AAC, AAAC, ACAR)



Qualified for use on YCP-L Compression Pulling Heads

See Important Notes page at start of Section.

**PATRIOT® 11 Ton, Latch Head, Dieless
Hydraulic Self-Contained, 18V Lithium-Ion**

Tool Series: PAT644

- Dieless system
- Range taking capabilities
- 355° head rotation
- Ergonomically balanced
- Includes 2 batteries, charger, and case
- **EP Enhanced Power** — tools accept 2.0, 3.0, 4.0, 5.0, and 6.0Ah Makita batteries

For Use On:

Copper #4 - 1000 kcmil Code; #2 - 777 kcmil Flex
Terminals: YA-L, YA-2LN, YA, YA-2N, YA-L-2TC, YAB-4N, YA-L-TC, YA-2L, YA-4N,
YAV, YAZ, YA-L-FX, YA-FXB, YBA, YAG
Splices: YS-L, YS, YS-T
HYPLUG™: YE-P, YE-P-FX, YEV-P-FX

Aluminum #6 AWG - 900 kcmil
Terminals: YA-A, YA-A-TN
Splices: YS-A
HYPLUG™: AYP, AYPO

ACSR, AAC, AAAC, ACAR #4 AWG - 556.5 kcmil
Splices: YDS-RL, YDS-RLNI

Cable Pulling Heads: YCP-L
#6 AWG - 1000 kcmil (copper & aluminum)

See Expanded Range details in Reference Section



Models:

PAT644LI with 3.0Ah Li-Ion batteries, hard case
PAT644L5 with 5.0Ah Li-Ion batteries, hard case

PAT644LIPB with 3.0Ah Li-Ion batteries, pro bag
PAT644L5PB with 5.0Ah Li-Ion batteries, pro bag

Specifications:

Output Force: 11 Tons
Tool Weight: 14.55 lbs (without battery)
Size: 15.62" x 14.12" x 3.25"
Die Style: Dieless
Operating Voltage: 18 V-DC Lithium-Ion
Recharge Time: 30 minutes (3.0Ah)
45 minutes (5.0Ah)
Warranty: 5 year limited warranty
Lifetime warranty on INFINITY DRIVE®
3 year on batteries and charger

Accessories:

BAT18VLI: 3.0Ah Li-Ion battery
BAT18V5AHLI: 5.0Ah Li-Ion battery
PATCHGRLI: 120V-AC Charger
PATCHGRLIDC: 12/24V-DC Charger
PT208620: Lanyard
FORCEGAUGE11: Force Test Gauge

Connections are UL Listed to UL 486A-486B
on BURNDY® Copper and Aluminum Terminals and Splices



Complies with ANSI C119.4 on YDS-RL and YDS-RLNI Splices
(ACSR, AAC, AAAC, ACAR)



Qualified for use on YCP-L Compression Pulling Heads

See Important Notes page at start of Section.

PATRIOT® 4-POINT® 6 Ton, Latch Head, Dieless Hydraulic Self-Contained, 18V Lithium-Ion

Tool Series: PAT81K2

- Dieless system with range taking capabilities
- Unique crimping guides for improved reliability and ease of use
- 360° head rotation
- Mechanical ram release
- Includes guides, 2 batteries, charger, and case
- EP Enhanced Power — tools accept 2.0, 3.0, 4.0, 5.0, and 6.0Ah Makita batteries

For Use On:

Copper #8 - 1000 kcmil

Terminals: YA, YA-L

Splices: YS-L, YS, YS-T, Y-R

Copper Flex #8 - 777.7 kcmil Flex

Terminals: YA-FX, YAV, YA-L-FX

Splices: YS, YSV-FXB

Aluminum #8 - 750 kcmil

Terminals: YA-A, YA-A-TN

Splices: YS-A

HYPLUG™: AYP, AYPO

See Expanded Range details in Reference Section



Shown with large connector guides (included)

Models:

PAT81K2U03A2

PAT81K2U05A2

with 3.0Ah Li-Ion batteries, hard case

with 5.0Ah Li-Ion batteries, hard case

PAT81K2U03A3

PAT81K2U05A3

with 3.0Ah Li-Ion batteries, pro bag

with 5.0Ah Li-Ion batteries, pro bag

Specifications:

Output Force:	6 Tons
Tool Weight:	11.05 lbs (without battery)
Size:	15.20" x 14.93" x 3.25"
Die Style:	Dieless
Operating Voltage:	18 V-DC Lithium-Ion
Recharge Time:	30 minutes (3.0Ah) 45 minutes (5.0Ah)
Warranty:	5 year limited warranty Lifetime warranty on INFINITY DRIVE® 3 year on batteries and charger

Accessories:

BAT18VLI:	3.0Ah Li-Ion battery
BAT18V5AHLI:	5.0Ah Li-Ion battery
PATCHGRLI:	120V-AC Charger
PATCHGRLIDC:	12/24V-DC Charger
PT208620:	Lanyard
81KSMLGUIDEKIT:	Kit, Small Crimp Guides (included with tool)
81KLRGGUIDEKIT:	Kit, Large Crimp Guides (included with tool)



Small Guides:
Copper #8-4 AWG
Aluminum #8-6 AWG



Large Guides:
Copper #3 AWG-#250 kcmil
Aluminum #5-3/0 AWG

See Important Notes page at start of Section.

**PATRIOT® 4-POINT® 6 Ton, C-Head, Dieless
Hydraulic Self-Contained, 18V Lithium-Ion**

Tool Series: PAT4PC834

- Dieless system
- Range taking capabilities
- 360° head rotation
- Ergonomically balanced
- Includes 2 batteries, charger, and case
- **EP Enhanced Power** — tools accept 2.0, 3.0, 4.0, 5.0, and 6.0Ah Makita batteries

For Use On:

Copper

Terminals: YA, YA-L (#8-1000 kcmil)
Splices: YS-L, YS, YS-T, Y-R (#8-500 kcmil)

Copper Flex

Terminals: YA-FX, YAV, YA-L-FX (#8-777.7 Flex)
Splices: YS, YSV-FXB (#8-500 kcmil)

Aluminum

Terminals: YA-A, YA-A-TN (#8-750 kcmil)
Splices: YS-A (#8-350 kcmil)*
HYPLUG™: AYP, AYPO (#8-750 kcmil)

*1.06" barrel diameter maximum for splices due to jaw opening

See Expanded Range details in Reference Section



Models:

- | | |
|---------------|--|
| PAT4PC834LI | with 3.0Ah Li-Ion batteries, hard case |
| PAT4PC834L5 | with 5.0Ah Li-Ion batteries, hard case |
| PAT4PC834LIPB | with 3.0Ah Li-Ion batteries, pro bag |
| PAT4PC834L5PB | with 5.0Ah Li-Ion batteries, pro bag |

Specifications:

- | | |
|--------------------|--|
| Output Force: | 6 Tons |
| Tool Weight: | 12.50 lbs (without battery) |
| Size: | 15.62" x 13.20" x 3.25" |
| Die Style: | Dieless |
| Operating Voltage: | 18 V-DC Lithium-Ion |
| Recharge Time: | 30 minutes (3.0Ah)
45 minutes (5.0Ah) |
| Warranty: | 5 year limited warranty
Lifetime warranty on INFINITY DRIVE®
3 year on batteries and charger |

Accessories:

- | | |
|--------------|----------------------|
| BAT18VLI: | 3.0Ah Li-Ion battery |
| BAT18V5AHLI: | 5.0Ah Li-Ion battery |
| PATCHGRLI: | 120V-AC Charger |
| PATCHGRLLDC: | 12/24V-DC Charger |
| PT208620: | Lanyard |

See Important Notes page at start of Section.

PATRIOT® 6 Ton, Latch Head Hydraulic Self-Contained, 18V Lithium-Ion

Tool Series: PAT600

- Permanent functional D3 groove (no die needed)
- Uses W and X style dies
- 180° head rotation
- Enhanced clearance for tap connections
- Includes 2 batteries, charger, and case
- EP Enhanced Power — tools accept 2.0, 3.0, 4.0, 5.0, and 6.0Ah Makita batteries

For Use On:

Copper #8 - 600 kcmil

Terminals: YA, YA-L
Splices: YS-L, YS, YS-T, Y-R

Copper Flex #8 - 350 kcmil Flex

Terminals: YA-FX, YAV, YA-L-FX
Splices: YS, YSV-FXB

Aluminum #8 - 350 kcmil

Terminals: YA-A, YA-A-TN
Splices: YS-A



* When used with UL Listed/CSA Certified YA, YS, YA-A, and YS-A series terminals and splices, connections are UL/CSA. Range taking dies also for use on the YAV and YSV series.



Models:

PAT600LJ with 3.0Ah Li-Ion batteries, hard case
PAT600L5 with 5.0Ah Li-Ion batteries, hard case

PAT600LIPB with 3.0Ah Li-Ion batteries, pro bag
PAT600L5PB with 5.0Ah Li-Ion batteries, pro bag

Specifications:

Output Force:	6 Tons
Tool Weight:	8.65 lbs (without battery)
Size:	14.50" x 13.75" x 3.50"
Die Style:	W and X
Operating Voltage:	18 V-DC Lithium-Ion
Recharge Time:	30 minutes (3.0Ah) 45 minutes (5.0Ah)
Warranty:	5 year limited warranty Lifetime warranty on INFINITY DRIVE® 3 year on batteries and charger

Accessories:

BAT18VLI:	3.0Ah Li-Ion battery
BAT18V5AHLI:	5.0Ah Li-Ion battery
PATCHGRLI:	120V-AC Charger
PATCHGRLIDC:	12/24V-DC Charger
PT208620:	Lanyard
WDIETREE:	W die holder
WDC4500*:	Range taking die for #4 - 500 Cu Str. and #2 - 4/0 Cu Flex
WDA8300*:	Range taking die for #8 - 300 Al, #6 - 400 Cu Str. and #2 - 4/0 Cu Flex

See Important Notes page at start of Section.

PATRIOT® 6 Ton, Scissor Action
Hydraulic Self-Contained, 18V Lithium-Ion

Tool Series: PAT500SJ

- Interchangeable scissor action crimping and cutting jaws
- 180° head rotation
- Uses W and X style dies
- Ergonomically balanced tool design
- Includes 2 batteries, charger, and polymer carrying case
- EP Enhanced Power — tools accept 2.0, 3.0, 4.0, 5.0, and 6.0Ah Makita batteries

For Use On:

Copper, Aluminum, ACSR, Steel, Copperweld, Alumoweld, 6201, 5005, Compressed, and Compact Conductors

Taps:

- Copper: #10 sol. to 2/0 str.
- Aluminum & ACSR: #14 sol. to 4/0 ACSR

Stirrups:

- #6 to 4/0 ACSR

Overhead Full Tension Deadends, Full Tension Splices and

Terminals:

- #10 str. to 4/0 ACSR

Installs Splices, Taps or Terminations:

- #8 to 500 kcmil Copper Stranded (YA, YA-L, YS, YS-L)
- #8 to 350 kcmil Copper Flex
- #8 to 350 kcmil Aluminum (YA-A, YS-A)

Interchangeable Jaw Assemblies:

PATMD6LWJAW	Crimp jaw with BG and D3 grooves
PATMD68LWJAW	Crimp jaw with O and D3 grooves
PATMD66LWJAW	Crimp jaw with D3 groove only
PATMDXPJLWJAW	Crimp jaw with X, P & J grooves
PATMD430LWJAW	Crimp jaw, Dieless, #4 AWG - 3/0 AWG
PATMDCUTLWJAW	Cutting jaw with ACSR blades
PATMDCUTCLWJAW	Cutting jaw with CU/AL blades
PATMDCUTGLWJAW	Cutting jaw with GUY blades

Accessories:

BAT18VLI:	3.0Ah Li-Ion battery
BAT18V5AHLI:	5.0Ah Li-Ion battery
PATCHGRLI:	120V-AC Charger
PATCHGRLIDC:	12/24V-DC Charger
PATMD6LWJWCVR:	Jaw covers for PATMD6 and PATMD68 versions
PATMD66LWJWCVR:	Jaw covers for PATMD66 snub-nose versions
PT10074020:	Wrist strap
W28K:	Cutter Dies (cuts 4-4/0 Cu, Al, ACSR)
WDIETREE:	W-die holder for 6 die sets



Models:

PAT500SJ6LI	BG and D3 grooves (3.0Ah)
PAT500SJ68LI	O and D3 grooves (3.0Ah)
PAT500SJ66LI	D3 groove only (snub-nose) (3.0Ah)
PAT500SJ6L5	BG and D3 grooves (5.0Ah)
PAT500SJ68L5	O and D3 grooves (5.0Ah)
PAT500SJ66L5	D3 groove only (snub-nose) (5.0Ah)

Crimp/Cut Kits:

PAT500SJ6LICUTKIT1	Kit includes crimp head with BG & D3 grooves, cutter jaw with ACSR blades, 120V charger and 2 batteries (3.0Ah)
PAT500SJ68LICUTKIT1	Kit includes crimp head with O & D3 grooves, cutter jaw with ACSR blades, 120V charger and 2 batteries (3.0Ah)

Specifications:

Output Force:	6 Tons
Tool Weight:	10.10 lbs (without battery)
Size:	17.00" X 14.25" X 3.00"
Die Style:	W and X (with crimping jaws)
Operating Voltage:	18 V-DC Lithium-Ion
Recharge Time:	30 minutes (3.0Ah) 45 minutes (5.0Ah)
Warranty:	5 year limited warranty Lifetime warranty on INFINITY DRIVE® 3 year on batteries and charger

See Important Notes page at start of Section.

PATRIOT® 6 Ton, Scissor Action Hydraulic Self-Contained, 18V Lithium-Ion

Tool Series: PATMD-LW

- Light weight, compact and ergonomic design
- Interchangeable scissor action crimping and cutting jaws
- Safety trigger lock and locking jaw tabs
- LED Worklight
- EP Enhanced Power — tools accept 2.0, 3.0, 4.0, 5.0, and 6.0Ah Makita batteries

Crimp Capacity*		
Connector Type	Conductor Type	Range
Terminals & Splices	Copper	#8 AWG - 500 kcmil
Terminals & Splices	Flex Copper	#8 AWG - 350 kcmil
Terminals & Splices	Aluminum (AAC)	#8 AWG - 350 kcmil
Full-Tension	ACSR	#10 - 4/0 AWG
Taps	Copper	#10 - 2/0 AWG
Taps	AAC or ACSR	#14 - 4/0 AWG
Stirrups	ACSR	#6 - 4/0 AWG

**Dieless Jaw only for use on #4-3/0 BURNDY® Overhead Distribution Families: YDS-RL, YDSR-RL, YDS-RLY, YDR-RL, YDRR-RL, YCS-RL, YCA-RL & YSS-R

Interchangeable Jaw Assemblies:

*PATMD6LWJAW	Crimp jaw with BG and D3 grooves
*PATMD68LWJAW	Crimp jaw with O and D3 grooves
*PATMD66LWJAW	Crimp jaw with D3 groove only
PATMDXPJLWJAW	Crimp jaw with X, P, & J grooves
**PATMD430LWJAW	**Crimp jaw, Dieless for #4-3/0 AWG
PATMDCUTLWJAW	Cutting jaw with ACSR blades
PATMDCUTCLWJAW	Cutting jaw with CU/AL blades
PATMDCUTGLWJAW	Cutting jaw with GUY blades

Standard Crimp/Cut Kits are available supplied with both crimping and cutting jaws. (See separate pages in Cutters Section.)

Customize a tool kit with up to 3 jaws and optional accessories.

Contact Customer Service at 1-800-346-4175.

Accessories:

BAT18VLI:	Hi-capacity LI Makita battery (3.0Ah)
BAT18V5AHLI:	Hi-capacity LI Makita battery (5.0Ah)
PATCHGRLI:	120V-AC Makita charger
PATCHGRLIDC:	12/24V-DC Makita charger
W28K:	Cutter Dies (cuts 4-4/0 CU, AL, ACSR)
WDIETREE:	W-die holder for 6 die sets
CASEWDIES:	W-die case holder for 12 die sets
TOOLBAGMDLI:	Tool bag (included with tool)

Shown with
BG / D3
Grooves



Interchangeable Jaws



Models:

PATMD6LW:	BG and D3 grooves, 3.0Ah batteries
PATMD68LW:	O and D3 grooves, 3.0Ah batteries
PATMD66LW:	D3 groove only, 3.0Ah batteries
PATMD70003A1:	XPJ grooves, 3.0Ah batteries
**PATMD80003A1:	**#4-3/0 dieless, 3.0Ah batteries
PATMD6LW5:	BG and D3 grooves, 5.0Ah batteries
PATMD68LW5:	O and D3 grooves, 5.0Ah batteries
PATMD66LW5:	D3 groove only, 5.0Ah batteries
PATMD70005A1:	XPJ grooves, 5.0Ah batteries
**PATMD80005A1:	**#4-3/0 dieless, 5.0Ah batteries

Specifications:

Output Force:	6 Tons
Tool Weight:	5.50 lbs (without battery)
Length:	17.85" - 18.73" (varies by jaw size)
Die Style*:	W and X (with crimping jaws; excluding XPJ grooves and 430 Dieless)
Operating Voltage:	18 V-DC Lithium-Ion
Recharge Time:	
3.0Ah	30 minutes
5.0Ah	45 minutes
Warranty:	5 year limited warranty Lifetime warranty on INFINITY DRIVE® 3 years on batteries and charger

See Important Notes page at start of Section.

HYPRESS™ 12 Ton, C-Head
Hydraulic Self-Contained, Hand Operated

Tool Series: Y750HSXT

- 355° head rotation
- 1.65" jaw opening
- Rapid advance pump
- Uses standard BURNDY U dies (sold separately)

For Use On:

Tension Sleeves

Copper	#8 sol. - 500 kcmil
Aluminum	#8 sol. - 587.2 kcmil
ACSR	#4 - 556.5 kcmil

Taps

Copper	#14 sol. - 500 kcmil
Aluminum	#8 - 500 kcmil

Aerial Cable

Copper	#6 - 500 kcmil
--------	----------------

Terminals & Splices

Copper	#8 - 750 kcmil
Aluminum	#8 - 750 kcmil
ACSR	#4 - 556.5 kcmil

HYGROUND® (Compression Grounding)

Copper	#8 - 500 kcmil
Ground Rods	1/2" - 1" diameter



Models:

Y750HSXT	Standard C-Head tool
Y750CHSXT	Y750HSXT with rubber covered head

Specifications:

Output Force:	12 Tons
Tool Weight:	14.5 lbs
Size:	23.96" x 8.71" x 2.90"
Die Style:	U
Jaw Opening:	1.65"
Warranty:	5 year limited warranty

Accessories:

PT10024162:	Plastic carrying case for Y750HSXT/Y750CHSXT
FORCEGAUGE1215:	Force test gauge for accurate reading of output force
CASEUDIES15:	Plastic die case for U dies

HYPRESS™ 12 Ton, C-Head Hydraulic Self-Contained, Hand Operated

Tool Series: Y35

- 180° head rotation
- Uses BURNDY U style dies (sold separately)
- Body and handles rubber covered for impact protection
- Trigger controlled ram release

For Use On:

Copper #8 str. - 500 kcmil code cable

Grounding Terminals:

YGH, YGHA, YGF

Grounding Splices:

YGS, YGHS

Copper #8 str. - 500 kcmil and up to 3/4" ground rod

Grounding Taps:

YGHC-C, YGHP-C, YGHR-C

Copper #8 str. - 750 kcmil code cable, N30 - N500 Navy cable, flexible, and extra flex

Terminals (Bare):

YA, YA-2N, YA-L, YA-LB, YA-2LN

Terminals (Insulated):

YAEV-L, YAEV-H, YAEV-RS, YAEV-RH

Splices to 400 kcmil only:

YS, YS-T, YS-L, YS-LB, YSV-L, YSM

Aluminum #8 str. - 750 kcmil code cable

Terminals:

YA-A, AYP, AYPO

Splices to 350 kcmil only:

YSA, YRB, YS-AT

ACSR - see Overhead Transmission & Distribution Sections

H & I of the current BURNDY® Master Catalog



Models:

Y35

Standard C-Head tool (rubber covered body and handles only)

Y352

Y35 with rubber covered head, body, and handles

Specifications:

Output Force:	12 Tons
Tool Weight:	13.5 lbs
Size:	23.25" x 4.75" x 2.75"
Die Style:	U
Warranty:	5 year limited warranty

Accessories:

PT2972:

Steel Carry Case (included with tool)

Y35/Y39REPKITA:

Seal Repair Kit

PT292792

12 ton Force Gauge

HYPRESS™ 11 Ton, Latch Head, Dieless
Hydraulic Self-Contained, Hand Operated

Tool: Y644HSXT

- 355° head rotation
- Dieless System
- Range taking capabilities
- Only "1" crimp necessary for most standard and long barrel terminals and splices
- Easy inspection; positive identification proved with BURNDY® 'Bug' (⊕) embossment after crimp completion

For Use On:

Copper #4 - 1000 kcmil Code; #2 - 777 kcmil Flex

Terminals: YA-L, YA-2LN, YA, YA-2N, YA-L-2TC,
YAB-4N, YA-L-TC, YA-2L, YA-4N, YAV, YAZ,
YA-L-FX, YA-FXB, YBA, YAG

Splices: YS-L, YS, YS-T

HYPLUG™: YE-P, YE-P-FX, YEV-P-FX

Aluminum #6 - 900 kcmil

Terminals: YA-A, YA-A-TN

Splices: YS-A

HYPLUG™: AYP, AYPO

ACSR, AAC, AAAC, ACAR #4 AWG - 556.5 kcmil

Splices: YDS-RL

Cable Pulling Heads: YCP-L
#6 AWG - 1000 kcmil (copper & aluminum)

See Expanded Range details in Reference Section



Models:

Y644HSXT Standard Dieless Latch Head tool

Specifications:

Output Force:	11 Tons
Tool Weight:	15.0 lbs
Size:	23.20" x 7.04" x 3.00"
Die Style:	Dieless
Warranty:	5 year limited warranty

Accessories:

Y644HSCASE: Plastic carrying case (included with tool)

Connections are UL Listed to UL 486A-486B
on BURNDY® Copper and Aluminum Terminals and Splices



Complies with ANSI C119.4 on YDS-RL and YDS-RLNI Splices
(ACSR, AAC, AAAC, ACAR)



Qualified for use on YCP-L Compression Pulling Heads

4-POINT® 6 Ton, Latch Head, Dieless Hydraulic Self-Contained, Hand Operated

Tool: Y81K2

- Dieless System
- Range taking capabilities
- Unique crimping guides for improved reliability and ease of use
- Flip top latch head design
- 360° head rotation

For Use On:

Copper #8 -1000 kcmil

Terminals: YA, YA-L
Splices: YS-L, YS, YS-T, Y-R

Copper Flex #8 - 777.7 kcmil Flex

Terminals: YA-FX, YAV, YA-L-FX
Splices: YS, YSV-FXB

Aluminum #8 - 750 kcmil

Terminals: YA-A, YA-A-TN
Splices: YS-A
HYPLUG™: AYP, AYPO

See Expanded Range details in Reference Section



Shown with large
connector guides
(included)

Models:

Y81K2

Standard 4-POINT® Dieless Latch Head tool

Specifications:

Output Force:	6 Tons
Tool Weight:	13.6 lbs
Size:	23.90" x 7.70" x 2.50"
Die Style:	Dieless
Warranty:	5 year limited warranty

Accessories:

PT10050733:	Plastic carrying case (included with tool)
81KSMLGUIDEKIT:	Kit, Small Crimp Guides (included with tool)
81KLRGGUIDEKIT:	Kit, Large Crimp Guides (included with tool)



Small Guides:
Copper #8-4 AWG
Aluminum #8-6 AWG



Large Guides:
Copper #3 AWG-#250 kcmil
Aluminum #5-3/0 AWG

4-POINT® 6 Ton, C-Head, Dieless
Hydraulic Self-Contained, Hand Operated

Tool: Y4PC834

- 360° head rotation
- Dieless System
- Range taking capabilities
- Handle trigger release

For Use On:

Copper

Terminals: YA, YA-L (#8-1000 kcmil)
Splices: YS-L, YS, YS-T, Y-R (#8-500 kcmil)

Copper Flex

Terminals: YA-FX, YAV, YA-L-FX (#8-777.7 Flex)
Splices: YS, YSV-FXB (#8-500 kcmil)

Aluminum

Terminals: YA-A, YA-A-TN (#8-750 kcmil)
Splices: YS-A (#8-350 kcmil)*
HYPLUG™: AYP, AYPO (#8-750 kcmil)

*1.06" barrel diameter maximum for splices due to jaw opening

See Expanded Range details in Reference Section



Models:

Y4PC834

Standard 4-POINT® Dieless C-Head tool

Specifications:

Output Force:	6 Tons
Tool Weight:	11.9 lbs
Size:	25.62" x 7.75" x 2.50"
Die Style:	Dieless
Warranty:	5 year limited warranty

Accessories:

PT10050733:

Plastic Carrying Case (included with tool)

L'IL CRIMP™ 6 Ton, Latch Head Hydraulic Self-Contained, Hand Operated

Tool: Y500CTHS

- Permanent functional D3 groove (no die needed)
- Used with W and X style dies
- 180° head rotation
- Enhanced clearance for tap connectors

For Use On:

Copper, Aluminum, ACSR, Steel, Copperweld, Alumoweld, 6201, 5005, Compressed, Compact, Stranded and Solid conductors

Installs Splices, Taps or Terminations:

- #8 - 600 kcmil Copper Str.
- #8 - 350 kcmil Flex
- #8 - 350 kcmil Aluminum



Models:

Y500CTHS

Standard Latch Head tool



*WDC4500 range taking die for
#4 - 500 Cu Str. and
#2 - 4/0 Cu Flex
(sold separately)*

*WDA8300 range taking die for #8 - 300 Al,
#6 - 400 Cu Str. and #2 - 4/0 Cu Flex
(sold separately)*



Specifications:

Output Force:	6 Tons
Tool Weight:	7.8 lbs
Size:	18.00" x 5.50" x 2.68"
Die Style:	W and X
Warranty:	5 year limited warranty

Accessories:

WDC4500*:	Range taking die for #4 - 500 Cu Str. and #2 - 4/0 Cu Flex
WDA8300*:	Range taking die for #8 - 300 Al, #6 - 400 Cu Str. and #2 - 4/0 Cu Flex
PT212851:	Metal Carrying Case (included with tool)

* When used with UL Listed/CSA Certified YA, YS, YA-A, and YS-A series terminals and splices, connections are UL/CSA.
Range taking dies also for use on the YAV and YSV series.

**60 Ton, Latch Head, Remote Powered
Single Acting Light Weight Hydraulic Tool**

Tool: Y60LW

- Remote power operated
- Used with BURNDY L, wide L style dies, and HPS/Fargo-equivalent 60 ton dies
- Base stand and metal carry case (for head only) included
- Side lift handle

For Use On:

Copper 300 - 2000 kcmil Str. Code Cable
Terminals: YA, YA-2N, YA-4N, YA-L, YA-2LN, YA-LB
Splices: YS, YST, YS-L, YS-T, YSP-T

Aluminum 250 - 2000 kcmil Str. Code Cable
Terminals: YA-A
Splices: YS-A, YS-AT

Transmission & Distribution Connectors:

Tension Sleeves:

Copper: 1/0 str. - 1000 kcmil

Aluminum: 1/0 str. - 2300 kcmil

ACSR: 1/0 str. - 2156 (84/19 str.) kcmil

Aerial:

Copper: 4/0 str. - 2500 kcmil

Aluminum: 3/0 str. - 2500 kcmil

Types: YTS, YTN, YNS, YNA, YNT, YNTA, YNU, YDS,
YDN, YCS, YCA, YCU



Models:

Y60LW

Standard Remote Latch Head tool

Specifications:

Output Force:	60 Tons
Tool Weight:	43.0 lbs
Size:	12.93" x 8.06" x 8.06"
Die Style:	L (standard or wide style); HPS/Fargo-equivalent 60 ton dies
Operating Pressure:	10,000 PSI
Warranty:	5 year limited warranty

Accessories:

Y60LWSTAND:	Metal stand for Y60LW (included with tool)
Y60LWCASE:	Steel carry case for Y60LW head (included with tool)

*See Gas or Electric Pumps and Hydraulic Hoses;
Pump Accessories for other necessary equipment.*



Wide L-dies (sold separately) can be used to save time and labor! Indicator marks on die set for ease of aligning connector properly. L725W shown.



*Y60LW pictured on
Y60LWSTAND
(included with tool purchase)*

15 Ton, Remote C-Head Remote Operated Hydraulic Tool

Tool Series: Y46LWSBH

- 2" jaw opening
- Used with P dies; U dies with PUADP1 adapter (sold separately)
- Positive push button die locks
- Light weight scoop style open head design



For Use On:

Copper - #8 AWG Str. - 1500 kcmil

Code Cable, Navy Cable, Flexible, Extra Flexible
1/2" - 1" Ground Rods

Terminals, grounding:

to 500 kcmil: YGA, YGHA, YGF

Terminals, uninsulated:

#8 - 1500 kcmil: YA, YA-2N, YA-L, YA-LB, YA-TC,
YA-2LN, YAB-4N, YAV-L, YAV-RS, YA-TC-FX

Terminals, insulated:

#8 - 2/0 AWG: YAEV-L, YAEV-H, YAEV-RS, YAEV-RH

Splices:

#8 - 1500 kcmil: YS, YS-T, YS-L, YS-LB, YST,
YSP-T, YGS, YGHS

Taps:

#14 - 1000 kcmil: YH, YCHC
to 4/0 AWG: YC-C

Taps, grounding:

to 500 kcmil: YGHC-C, YGHP-C, YGHR-C

Aluminum - #8 AWG - 1250 kcmil

Code Cables

Terminals: YA-A, AYP, AYPO

Splices: YS-A, YS-AT, YRB

Taps: YFD, YFN, YFO, YFR

ACSR - See Overhead Transmission & Distribution

Sections H & I of the current BURNDY® Master Catalog

Models:

Y46LWSBH
Y46CLWSBH

Standard Light Weight C-Head tool
Permanently molded head of 3/16" rubber
included separate molded rubber boot for
lower body and hydraulic coupler
Y46CLWSBH (covered) tool with Female coupler
Y46LWSBH tool with Female coupler
(not rubber covered)

Y46CLWSBHF
Y46LWSBHF

Specifications:

Output Force:	15 Tons
Tool Weight:	14.5 lbs
Size:	14.68" x 5.06" x 2.88"
Die Style:	P and U (with PUADP1)
Operating Pressure:	10,000 PSI
Cycles:	10,000
Warranty:	5 year limited warranty

Accessories:

PUADP1:	U die adapter
P15K:	Cutter Die, max. diameter 1.2"
PT10054094:	Red Nylon Carry Bag (included with tool)

*See Hydraulic Pumps and Hydraulic Hoses;
Pump Accessories
for other necessary equipment.*

15 Ton, Remote Latch Head
Remote Operated Hydraulic Tool

Tool Series: Y46LWBH

- 2" ram travel
- Used with P dies; U dies with PUADP1 adapter (sold separately)
- Positive push button die locks
- Light weight latch head design

For Use On:

Copper - #8 AWG Str. - 1500 kcmil

Code Cable, Navy Cable, Flexible, Extra Flexible
1/2" - 1" Ground Rods

Terminals, grounding:

to 500 kcmil; YGA, YGHA, YGF

Terminals, uninsulated:

#8 - 1500 kcmil; YA, YA-2N, YA-L, YA-LB, YA-TC,
YA-2LN, YAB-4N, YAV-L, YAV-RS, YA-TC-FX

Terminals, insulated:

#8 - 2/0 AWG; YAEV-L, YAEV-H, YAEV-RS, YAEV-RH

Splices:

#8 - 1500 kcmil; YS, YS-T, YS-L, YS-LB, YST,
YSP-T, YGS, YGHS

Taps:

#14 - 1000 kcmil; YH, YCHC
to 4/0 AWG; YC-C

Taps, grounding:

to 500 kcmil; YGHC-C, YGHP-C, YGHR-C

Aluminum - #8 AWG - 1250 kcmil

Code Cables

Terminals: YA-A, AYP, AYPO

Splices: YS-A, YS-AT, YRB

Taps: YFD, YFN, YFO, YFR

ACSR - See Overhead Transmission & Distribution

Sections H & I of the current BURNDY® Master Catalog



Models:

Y46LWBH
Y46LWBHF

Standard Light Weight Latch Head tool
Y46LWBH tool with Female coupler (not rubber covered)

Specifications:

Output Force:	15 Tons
Tool Weight:	12.4 lbs
Size:	14.88" x 5.06" x 3.07"
Die Style:	P and U (with PUADP1)
Operating Pressure:	10,000 PSI
Cycles:	10,000
Warranty:	5 year limited warranty

Accessories:

PUADP1:	U die adapter
P15K:	Cutter Die, max. diameter 1.2"
PT10054094:	Red Nylon Carry Bag (included with tool)

*See Hydraulic Pumps and Hydraulic Hoses;
Pump Accessories
for other necessary equipment.*

15 Ton, Remote C-Head Remote Operated Hydraulic Tool

Tool: Y45

- Lifting eye
- Fully protected ram and die buttons
- Used with S dies; U dies with PT6515 adapter (sold separately)

For Use On:

Tension Sleeves:

- Copper #8 sol. - 500 kcmil
- Aluminum #6 sol. - 954 kcmil
- ACSR #4 - 795 (26/7) kcmil

Taps:

- Aluminum #14 - 954 (18/1) kcmil
- ACSR #6 - 795 (54/7) kcmil

Aerial Cable Connectors:

- Copper #6 str. - 1500 kcmil
- Aluminum #4 str. - 1000 kcmil

HYGROUND® Compression Grounding:

- Copper #6 - 500 kcmil
- 1/2" - 1" ground rods

Code Cable Terminals/Splices:

- Copper #8 - 1500 kcmil
- Aluminum #8 - 1000 kcmil

Code Cable Taps:

- Copper #14 - 1000 kcmil
- Aluminum #14 - 900 kcmil



Models:

Y45

Standard Remote C-Head tool

Specifications:

Output Force:	15 Tons
Tool Weight:	15.5 lbs
Size:	15.25" x 4.50" x 2.62"
Die Style:	S and U (with PT6515)
Operating Pressure:	10,000 PSI
Cycles:	10,000
Warranty:	5 year limited warranty

Accessories:

PT6515:	Adapter for use with U die sets
PT6545:	Die carrying case for S and/or P die type dies. Holds eight (8) die sets. Dies sold separately.
433206016010:	Carry Case (included with tool)

*See Hydraulic Pumps and Hydraulic Hoses;
Pump Accessories
for other necessary equipment.*

12 Ton, Remote C-Head
Remote Operated Hydraulic Tool

Tool: Y750BHXT

- 1.65" jaw opening
- 355° head rotation
- Used with U style dies
- Exposed positive die lock buttons

For Use On:

Tension Sleeves

Copper	#8 sol. - 500 kcmil
Aluminum	#8 sol. - 587.2 kcmil
ACSR	#4 - 556.5 kcmil

Taps

Copper	#14 sol. - 500 kcmil
Aluminum	#8 - 500 kcmil

Aerial Cable

Copper	#6 - 500 kcmil
--------	----------------

Terminals & Splices

Copper	#8 - 750 kcmil
Aluminum	#8 - 750 kcmil
ACSR	#4 - 556.5 kcmil

HYGROUND® (Compression Grounding)

Copper	#8 - 500 kcmil
Ground Rods	1/2" - 1" diameter



Models:

Y750BHXT

Standard Remote C-Head tool

Specifications:

Output Force:	12 Tons
Tool Weight:	10.8 lbs
Size:	12.80" x 5.20" x 2.90"
Die Style:	U
Jaw Opening:	1.65"
Operating Pressure:	10,000 PSI
Warranty:	5 year limited warranty

Accessories:

PT294021:	Adjustable head grip for joining head to universal hot sticks
CASEUDIES15:	Plastic die case for U style dies Holds 15 die sets. Dies sold separately.
PT10054094:	Red Nylon Carry Bag (included with tool)

*See Hydraulic Pumps and Hydraulic Hoses;
Pump Accessories
for other necessary equipment.*

12 Ton, Remote C-Head Remote Operated Hydraulic Tool

Tool Series: Y35BH

- Lifting eye
- .95" jaw opening
- Uses U style dies
- Positive die lock buttons

For Use On:

Copper #8 str. - 500 kcmil code cable

Grounding Terminals:

YGH, YGHA, YGF

Grounding Splices:

YGS, YGHS

Copper #8 str. - 500 kcmil and up to 3/4" ground rod

Grounding Taps:

YGHC-C, YGHP-C, YGHR-C

Copper #8 str. - 750 kcmil code cable, N30 - N500 Navy cable, flexible, and extra flex

Terminals (Bare):

YA, YA-2N, YA-L, YA-LB, YA-2LN

Terminals (Insulated):

YAEV-L, YAEV-H, YAEV-RS, YAEV-RH

Splices to 400 kcmil only:

YS, YS-T, YS-L, YS-LB, YSV-L, YSM

Aluminum #8 str. - 750 kcmil code cable

Terminals:

YA-A, AYP, AYPO

Splices to 350 kcmil only:

YSA, YRB, YS-AT

ACSR: See Overhead Transmission & Distribution
Sections H & I of the current BURNDY® Master Catalog



Models:

Y35BH

Standard Remote C-Head tool

Y35H

Y35BH head, PT294021 universal hot stick adapter, and steel carrying case

Y35BH4

Permanent molded rubber head, 3/16" rubber for tool impact protection

Specifications:

Output Force:	12 Tons
Tool Weight:	8.0 lbs
Size:	9.25" x 4.75" x 2.62"
Die Style:	U
Jaw Opening:	.95"
Operating Pressure:	10,000 PSI
Cycles:	10,000
Warranty:	5 year limited warranty

Accessories:

PT29413: Carry Case (included with tool)

*See Hydraulic Pumps and Hydraulic Hoses;
Pump Accessories
for other necessary equipment.*

11 Ton, Remote C-Head, Dieless
Remote Operated Hydraulic Tool

Tool Series: Y444SBH

- New C-Head style for easy access and increased flexibility
- Dieless system with range taking capability
- Qualified on both UL and ANSI connections

For Use On:

Copper #4 - 1000 kcmil Code & Flex

Terminals: YA-L, YA-2LN, YA, YA-2N, YA-L-2TC, YAB-4N,
YA-L-TC, YA-2L, YA-4N, YAV, YAZ, YA-L-FX, YA-FXB,
YBA, YAG

Splices: YS-L, YS, YS-T

Copper #4 - 1000 kcmil Code; #2 - 777 kcmil Flex

HYPLUG™: YE-P, YE-P-FX, YEV-P-FX

Aluminum #4 - 1000 kcmil

Terminals: YA-A, YA-A-TN

Splices: YS-A

HYPLUG™: AYP, AYPO

ACSR, AAC, AAAC, ACAR #4 AWG - 556.5 kcmil

Splices: YDS-RL, YDS-RLNI

Cable Pulling Heads: YCP-L

#6 AWG - 1000 kcmil (copper & aluminum)

See Expanded Range details in Reference Section



Models:

Y444SBH

Tool with male couplers

Y444SBHF

Tool with female couplers

Specifications:

Output Force:	11 Tons
Tool Weight:	10.6 lbs
Size:	13.33" x 4.75" x 2.92"
Die Style:	Dieless
Operating Pressure:	10,000 PSI
Warranty:	5 year limited warranty

Accessories:

PT10054094

Red Nylon Carry Bag (included with tool)

See Hydraulic Pumps and Hydraulic Hoses;
Pump Accessories
for other necessary equipment.



Unique 444S Crimp
Embossment

Connections are UL Listed to UL 486A-486B
on BURNDY® Copper and Aluminum Terminals and Splices



Complies with ANSI C119.4 on YDS-RL and YDS-RLNI Splices
(ACSR, AAC, AAAC, ACAR)



Qualified for use on YCP-L Compression Pulling Heads

4-POINT® 6 Ton, Remote Latch Head, Dieless Remote Operated Hydraulic Tool

Tool: Y81K2MBH

- Dieless system with range taking capabilities
- Unique crimping guides for improved reliability and ease of use
- Flip top design
- Incorporates Parker-type quick connect 3/8" male coupler
- 360° head rotation

For Use On:

Copper #8 - 1000 kcmil

Terminals: YA, YA-L

Splices: YS, YS-L, YS-T, Y-R

Copper Flex #8 - 777.7 kcmil Flex

Terminals: YA-FX, YAV, YA-L-FX

Splices: YS, YSV-FXB

Aluminum #8 - 750 kcmil

Terminals: YA-A, YA-A-TN

Splices: YS-A

HYPLUG™: AYP, AYPO

See Expanded Range details in Reference Section



*Shown with small
connector guides
(included)*

Models:

Y81K2MBH

Standard 4-POINT® Dieless Remote tool

Specifications:

Output Force:	6 Tons
Tool Weight:	8.5 lbs
Size:	12.30" x 5.40" x 2.00"
Die Style:	Dieless
Operating Pressure:	10,000 PSI
Warranty:	5 year limited warranty

Accessories:

PT10054094:	Red Nylon Carry Bag (included with tool)
81KSMLGUIDEKIT:	Kit, Small Crimp Guides (included with tool)
81KLRGGUIDEKIT:	Kit, Large Crimp Guides (included with tool)

*See Hydraulic Pumps and Hydraulic Hoses;
Pump Accessories
for other necessary equipment.*



Small Guides:
Copper #8-4 AWG
Aluminum #8-6 AWG



Large Guides:
Copper #3 AWG-#250 kcmil
Aluminum #5-3/0 AWG

**4-POINT® 6 Ton, Remote C-Head, Dieless
Remote Operated Hydraulic Tool**

Tool: Y4PC834MBH

- Dieless System
- Range taking capabilities
- C-shaped head design
- 360° head rotation

For Use On:

Copper

Terminals: YA, YA-L (#8-1000 kcmil)
Splices: YS-L, YS, YS-T, Y-R (#8-500 kcmil)

Copper Flex

Terminals: YA-FX, YAV, YA-L-FX (#8-777.7 Flex)
Splices: YS, YSV-FXB (#8-500 kcmil)

Aluminum

Terminals: YA-A, YA-A-TN (#8-750 kcmil)
Splices: YS-A (#8-350 kcmil)*
HYPLUG™: AYP, AYPO (#8-750 kcmil)

*1.06" barrel diameter maximum for splices due to jaw opening

See Expanded Range details in Reference Section



Models:

Y4PC834MBH

Standard 4-POINT® Dieless Remote
C-Head tool

Specifications:

Output Force:	6 Tons
Tool Weight:	8.4 lbs
Size:	5.50" x 4.00" x 2.00"
Die Style:	Dieless
Operating Pressure:	10,000 PSI
Warranty:	5 year limited warranty

Accessories:

PT10054094: Red Nylon Carry Bag (included with tool)

*See Hydraulic Pumps and Hydraulic Hoses;
Pump Accessories
for other necessary equipment.*

9 Ton, Remote Latch Head Remote Operated Hydraulic Tool

Tool Series: Y34BH

- Molded rubber covering on head, body, and hose fittings
- Fast ram retraction
- Compact C-shaped forged head

For Use On:

Copper #4 - 500 kcmil code cable
Welding Cable: 350 kcmil
N40 to N500 Navy Cable
Flexible and Extra Flexible
#4 - 4/0 Aircraft Cable

HYLUG™ Terminals (Bare)
HYLINK™ Splices (Bare)

HYCRAB™ BURNDY® Network Connector System

Copper: #4 - 500 kcmil str.
Aluminum: #6 - 300 kcmil



Models:

Y34BH

9-Ton Remote C-Head tool

Specifications:

Output Force:	9 Tons
Tool Weight:	8.0 lbs
Size:	16.75" x 3.00" x 3.00"
Die Style:	B nest & Y34 series indenter dies
Jaw Opening:	1.10"
Operating Pressure:	10,000 PSI
Warranty:	5 year limited warranty

Installation Die Charts for Y34BH

Copper Conductor		
Installation Die		Max. Conductor
Nest	Indenter	
B4CD	Y34PR	#4 Str.
B2CD	Y34PR	#2 Str.
B1CD	Y34PR	#1 Str.
B25D	Y34PR	1/0 Str.
B26D	Y34PR	2/0 Str.
B27D	Y34PR	3/0 Str.
B28D	Y34PR	4/0 Str.
B29D	Y34PR	250 kcmil
B30D	Y34PR	300 kcmil
B31D	Y34PR	350 kcmil
No Die Req'd	Y34PR	500 kcmil

*See Hydraulic Pumps and Hydraulic Hoses;
Pump Accessories for other necessary equipment.*

Aluminum Conductor		
Installation Die		Max. Conductor
Nest	Indenter	
B4CD	Y34PA	#6 Str.
B1CD	Y34PA	#4 Str.
B25D	Y34PA	#2 Str.
B26D	Y34PR5	#1 Str.
B27D	Y34PR5	1/0 Str.
B29D	Y34PR5	2/0 Str.
B30D	Y34PR5	3/0 Str.
B31D	Y34PR5	4/0 Str.
B32D	Y34PR5	250 kcmil
No Die Req'd	Y34PR11	300 kcmil

4.5 Ton, 6,000 PSI, Remote C-Head
Remote Operated Hydraulic Tool

Tool: Y29BH

- D series nest dies and Y29 series indenter dies
- Light weight, portable design
- C-shaped head; 1.2" jaw opening
- Easy placement/removal on continuous conductor lengths

For Use On:

Copper #8 - 2/0 AWG Code/Flex

Nylon Insulated Lugs:

(Connectors meet MIL-T-7928 requirements)
YAEV-L, YAEV-H, YAEV-RS, YAEV-RH

Non-Insulated Lugs:

(Connectors meet MIL-T-7928 requirements)
YAV-L, YAV-R, YAV-RS

Copper #8 - 4/0 AWG

Non-Insulated Splices:

(Type YSV-L connectors UL Listed/CSA Certified)
YSM, YSV-L



Models:

Y29BH

4.5-Ton, 6,000 PSI, Remote C-Head tool

Specifications:

Output Force:	4.5 Tons
Tool Weight:	5.0 lbs
Size:	10.75" x 3.00" x 1.25"
Die Style:	D nest & Y29 series indenter dies
Jaw Opening:	1.15"
Operating Pressure:	6,000 PSI
Warranty:	5 year limited warranty

Installation Die Chart for Y29BH
(Connectors meet MIL-T-7928 requirements)

Non-Insulated Connectors		Maximum Conductor	Insulated Connectors	
Nest	Indenter	Size	Nest	Indenter
DV8L1	Y29PL	#8 AWG	DEV8L	Y29PLE1
DV6L	Y29PL	#6 AWG	DEV6L	Y29PLE1
DV4L	Y29PL	#4 AWG	DEV4L	Y29PLE1
DV2L	Y29PL	#2 AWG	DEV2L	Y29PLE
DV1L	Y29PL	#1 AWG	DEV26L	Y29PLE
DV25L	Y29PR	1/0 AWG	DEV25L	Y29PLE
DV26L	Y29PR	2/0 AWG	DEV26L	Y29PLE

Accessories:

PT30250: Metal carrying case (included with tool)

*See Hydraulic Pumps and Hydraulic Hoses;
Pump Accessories
for other necessary equipment.*



PT30250 metal carrying case (included with tool)

Y10D for Nylon & Bare Hand-held plier tool for #22 - #10 AWG

Tool: Y10D

- One tool for both nylon insulated and bare connectors
- Precision machined wire cutter for aluminum and copper
- Heavy duty forged steel, rust resistant finish

For Use On:

#22 - #10 AWG Nylon Insulated Terminals

Types: TN, TN-F, YAE-N, YAE-N-F, YAE-Z, YAEV, YAES,
YAES-E

#22 - #10 AWG Nylon Insulated Splices

Types: SN, YSE-HN*, SNM, YSES, YSE-H*

#22 - #10 AWG Bare Uninsulated Terminals

Types: T, YAD, T-F, YAD-F, YAV, YAV-T-F, YAV-H*, YAV-H-F*,
YAV-Z

#22 - #10 AWG Bare Uninsulated Splices

Types: YSV, YSV-H*



Models:

Y10D

Plier tool for #22 - #10 AWG; Nylon & Bare

Specifications:

Size:	9.75" x 5.00" x 1.00"
Weight:	13.5 oz.
Warranty:	5 year limited warranty

Dieless, Front Load, for Ferrules
Full cycle ratchet tool for covered / bare ferrules

Tool: YF2210FL

- Front load crimping position
- Dieless crimping without multiple grooves
- Full cycle ratchet mechanism
- Ratchet release lever

For Use On:

#22 - #10 AWG Covered and Bare Ferrules
Types: YF-UIL, YF-IDL, YF-ITL, YF-IWL, YFTW-DL
Wire End Ferrules



Crimp Profile

Close up of YF2210FL front load ratchet tool



Models:

YF1022FL Front Load Ferrule Crimp tool

Specifications:

Size:	7.75" x 2.32 x 1.00"
Die Style:	Dieless
Weight:	.82 lbs
Output Force:	1,600 lbs
Warranty:	5 year limited warranty

Dieless, Front Load, for Ferrules
Full cycle ratchet tool for covered / bare ferrules

Tool: YF268CFSL

- Rotatable die head for front or side loading
- Full cycle ratchet with emergency release
- Ergonomic design with low handle force with non slip comfort grip
- Self adjusting for covered and bare ferrules
- Compact and lightweight
- Hole for safety strap

For Use On:

#26 - #8 AWG Covered and Bare Ferrules
Types: YF-UIL, YF-IDL, YF-ITL, YF-IWL, YFTW-DL
Wire End Ferrules

Specifications:

Size:	7.10" x 2.70" x 0.90"
Die Style:	Dieless, Rotatable
Weight:	.65 lbs
Warranty:	5 year limited warranty



Models:

YF268CFSL Front & Side Load Ferrule Crimp tool



Close-up of YF268CFSL front load & side load views

Ratchet Tools for Ferrules Side Load, #26 AWG to 1/0 AWG

Tool Series: YF261CSKIT

- Kit includes ratchet crimping tool and 3 interchangeable dies: YF2610D (#26-10 AWG), YF864D (#8-4 AWG), and YF21D (#2-1/0 AWG)
- Crimps both covered and bare ferrules
- Low handle force reduces hand strain
- Ergonomic design with non-slip handles
- Light weight plastic case with handle for easy transporting
- Micro foam insert to secure tool, dies and die changing tool



For Use On:

#26 - 1/0 AWG Covered Ferrules
#20 - #2 AWG Bare Ferrules
Types: YF-UIL, YF-IDL, YF-ITL, YF-IWL, YFTW-DL
Wire End Ferrules

Models:

YF261CSKIT Kit, ferrule tool, dies for #26-1/0 AWG

Specifications (Kit):

Size:	10.00" x 2.70" x 0.90"
Die Style:	Interchangeable
Weight:	1.25 lbs
Warranty:	5 year limited warranty



Close-up of YF261CSKIT side load view



Full Cycle Ratchet Tool
Hand-held ratchet tool for #22 to #8 AWG

Tool: Y8MRB1

- Light weight
- Each indenter has unique identifying marks for inspectability
- Fully enclosed, protected ratchet mechanism does not allow the handles to be opened until full ratchet cycle is completed
- Inspection gauges (sold separately) available to check each groove

For Use On:

#22 - 8 AWG Uninsulated (Bare) Terminals:
Types: T, YAD, T-F, YAD-F, YAV, YAV-L, YAV-T-F, YAV-Z

#22 - 8 AWG Uninsulated (Bare) Splices:
Types: YSV, YSV-L



Models:

Y8MRB1 Hand-held tool, #22 - #8 AWG

Specifications:

Weight:	1.2 lbs
Size:	10.56" x 3.50" x 1.04"
Die Style:	Permanent Dies
Warranty:	5 year limited warranty

Accessories:

PG3951	Inspection gauge for #18 groove
PG3961	Inspection gauge for #14 groove
PG3971	Inspection gauge for #10 groove
PG3981	Inspection gauge for #8 groove

Fully Protected Ratchet Mechanism Full Cycle Ratchet Tools for Critical Applications

Tool Series: MR8

- Fully enclosed, protected ratchet mechanism does not allow the handles to be opened until full ratchet cycle is completed
- Designed for critical applications such as nuclear-class 1E terminations, heavy duty industrial, aircraft
- Light weight aluminum
- Easy groove identification with color-coded dies



For Use On:

MR81A: #22 - #10 AN Copper Cable
INSULUG™ terminals/splices
YAE

MR89Q: #18 - #8 AN Copper Cable
#22 - #10 AWG Sol. Cable
#22 - #8 AWG Str. Cable
YAV, YSV, T, T-F, YAD, YAD-F

MR833S1: #18 - #10 MIL-W-5086 Str.
YSE, YSE-H

MR8G96: #22 - #14
TP, BA

Models: (see For Use On)

MR81A
MR89Q
MR833S1
MR8G96

Specifications:

Size:	10.50" x 3.50" x 1.50"
Weight:	1.5 lbs
Die Style:	Permanent Dies
Warranty:	5 year limited warranty

Ergonomic Full Cycle Ratchet Tool
For #22 to #10 AWG; Nylon/Vinyl and Bare

Tool Series: MRE1022

- Ratchet mechanism does not allow handles to open until full cycle is complete
- Stop plate ensures proper location for consistent reliable connection
- Die Inspection Gauges available (sold separately)
- Easy groove identification with color coded dies
- Ratchet release lever in case of misalignment



For Use On:

MRE1022B

#22 - #10 AWG Uninsulated (Bare) Terminals/Splices
Types: T, YAD, T-F, YAD-F, YAV, YAV-H, YAV-R, YAV-T-F,
YAV-H-F, YAV-Z, YSV, YSV-H

MRE1022NV

#22 - #10 AWG Nylon & Vinyl Insulated Terminal/Splices
Types: TP, BA, TP-F, BA-EF, TP-Z, BA-EZ, TP-LF, BA-EL,
SP, BS, TN, YAES, TN-F, YAES-F, SNM*, YSES*,
YAE-N, YAE-N-F, YAE-Z, YSE-HN, YSE-H, YAEV

*Excludes #10 size

Models:

MRE1022B Tool, #22 - #10 AWG, Bare
MRE1022NV Tool, #22 - #10 AWG, Nylon/Vinyl

Specifications:

Weight: 1.3 lbs
Size: 10.50" x 3.00" x 1.00"
Die Style: Permanent Dies
Warranty: 5 year limited warranty



Close-up
MRE1022NV

Accessories:

PG4032R: Die Inspection Gauge for #22 - #14 AWG for MRE1022B
PG4031R: Die Inspection Gauge for #12 - #10 AWG for MRE1022B
PG4061: Die Inspection Gauge for #22 - #18 AWG (Red) for MRE1022NV
PG4071: Die Inspection Gauge for #16 - #14 AWG (Blue) for MRE1022NV
PG4081: Die Inspection Gauge for #12 - #10 AWG (Yellow) for MRE1022NV

Full Cycle Ratchet Hand-held Tool For #22 to #10 AWG Terminals/Splices

Tool Series: MR

- Ratchet mechanism does not allow handles to open until full cycle is complete
- Easy groove identification with color coded dies
- Compact, narrow nose
- Comfort grip handles
- Ratchet release lever in case of misalignment



For Use On:

MR15

#22 - #10 AWG Vinyl Insulated Terminals/Splices

Types: TP, BA, TP-F, BA-EF, TP-Z, BA-EZ, TP-LF, BA-EL, SP, BS

MR18

#22 - #10 AWG Nylon Insulated Terminals/Splices

Types: TN**, TN-F, YAES, YAES-F, SN, SNM, YSE-HN, YSES

MR20

#22 - #10 AWG Uninsulated (Bare) Terminals/Splices

Types: T, YAD-F, T-F, YAV-H*, YAV, YAV-H-F*, YAD, YAV-T-F, YSV, YSV-H*

*Conductor crimps only

**Excludes #10 Size

Models:

MR15	Tool, #22 - #10 AWG, Vinyl
MR18	Tool, #22 - #10 AWG, Nylon
MR20	Tool, #22 - #10 AWG, Bare

Specifications:

Size:	8.88" x 6.00" x 2.50"
Weight:	1.1 lbs
Warranty:	5 year limited warranty

Accessories:

MR15DIESETD1:	MR15 interchangeable die set
MR18DIESETD1:	MR18 interchangeable die set
MR20DIESETD1:	MR20 interchangeable die set

Full Cycle Ratchet Hand-held Tool
For #9 to #4 AWG; Bare Terminals/Splices

Tool: MR4C

- Reinforced heavy duty back with high strength aluminum body
- Fully protected ratchet mechanism does not allow handles to open until full cycle is completed
- Inspection gauges available to check each groove (sold separately)
- Spring loaded indenter jaw, keeps jaws closed

For Use On:

#9 - #4 AWG Uninsulated (Bare) Terminals/Splices
Types: YAV-L, YA-L, YSV, YS-L



Models:

MR4C

Tool, #9 - #4 AWG, Bare

Specifications:

Length:	11.75" x 3.62" x 1.00"
Weight:	2.3 lbs
Die Style:	Permanent Dies
Warranty:	5 year limited warranty

Accessories:

PG1211:	Die Inspection Gauge for #9 - #8 AWG groove
PG1251:	Die Inspection Gauge for #6 AWG groove
PG1331:	Die Inspection Gauge for #4 AWG groove

Rotating Die, Full Cycle Ratchet Tool For #8 to #1 AWG Copper HYDENT™ Terminals/Splices #14 to #4 Thin-Wall C-Taps

Tool Series: Y1MRTC

- Die index embossment
- Rotating die with color coding to match connectors
- Ratchet mechanism with release in case of misalignment

For Use On:

See charts for details

#8 - #1 AWG Uninsulated (Bare) Terminals and Splices

Types: YA, YAV, YS, YSV

#14 - #4 AWG Thin Wall C-Taps

YC10L12, YC8L12, YC6L12, YC4L12



Models:

Y1MRTC

Y1MRKIT

Y1MRTCKIT

Standard tool only

Y1MRTC tool, sturdy metal carrying case and select terminals/splices

Y1MRTC tool, sturdy metal carrying case, selected terminals and YC4L12 Thin-Wall C-Tap

Copper Terminals & Splices				
Copper Wire Size	Connector Catalog Types	Die Index # (Color)	# Crimps per Barrel Length	
			Std	Long
#8 AWG Code & Flex	YA8C-YS8C- YAV8C-YSV8C-	49 (Red)	1	2
#6 AWG Code	YA6C-YS6C-	7 (Blue)	1	2
#6 AWG Code & Flex	YAV6C-YSV6C-			
#4 AWG Code	YA4C-YS4C-	8 (Grey)	2	4
#4 AWG Code & Flex	YAV4C-YSV4C-			
#3 AWG #2 Sol.	YA3C-YS3C-	9 (White)	2	4
#2 AWG Code	YA2C-YS2C-	10 (Brown)**	2	4
#2 AWG Code & Flex	YAV2C-YSV2C-			
#1 AWG Code	YA1C-YS1C-	11 (Green)**	2	4

**Die Index 10/Brown and 11/Green use the same die wheel crimp groove.

Specifications:

Size: 9.88" x .75" x 2.75"
Weight: 1.7 lbs
Die Style: Rotating Die Wheel
Warranty: 5 year limited warranty

Copper C-Tap Connectors				
Catalog Number	Wire Size Cu Str. AWG		Die Index # (Color)	# of Crimps
	Run	Tap		
YC10L12	14 12 10	16-14 16-14 16	49 (Red)	1
YC8L12	10 8	10 12	7 (Blue)	1
YC6L12	8 6	10-8 12-10	8 (Grey)	1
YC4L12	6 5, 4	8-6 12-8	10 (Brown)	2

Ergonomic Full Cycle Ratchet Hand-held Tool
For #12 to #2 AWG; Stranded, Solid, Flex

Tool: Y122CMR

- Overmolded comfort grip handles
- Easy groove identification with color coded dies
- UL Listed/CSA Certified connections when used with recommended BURNDY terminals/splices
- Die index embossment for all 6 wire ranges
- Emergency release mechanism in case of misalignment or mistaken die choice
- Two different kits are also available with a selection of connectors in a sturdy metal carrying case (Y122CMRKIT and Y122CMRCIKIT)



Models:

- Y122CMR** Tool, #12 - #2 AWG
Y122CMRKIT Tool, select LONG barrel connectors, case
Y122CMRCIKIT Tool, select STANDARD barrel connectors, case

Accommodates Copper Terminals and Splices				
Copper Wire Size	Connector Catalog Types	Die Index # (Color Code)	Number of Crimps	
			Standard Barrel	Long Barrel
#10 - #12 AWG Sol. & Str.	T10-, YAD10-, YAV10, YAZ10, YAZV10-	-- (Yellow)	1	N/A
#8 AWG Code & Flex	YA8C-, YAV8C-, YAZ8C-, YAZV8C-, YS8C, YSV8C-	49 (Red)	1	2
#6 AWG Code	YA6C-, YAZ6C-, YS6C-	7 (Blue)	1	2
#6 AWG Code & Flex	YAV6C-, YAZV6C-, YSV6C-			
#4 AWG Code	YA4C-, YAZ4C-, YS4C-	8 (Gray)	2	4
#4 AWG Code & Flex	YAV4C-, YAZV4C-, YSV4C-			
#3 AWG Code & #2 AWG Sol	YA3C-, YS3C	9 (White)	2	4
#2 AWG Code	YA2C-, YAZ2C-, YS2C-	10 (Brown)	2	4
#2 AWG Code & Flex	YAV2C-, YAZV2C-, YSV2C-			

Gage Catalog Number	AWG Size	Die Index	Color Code
PG4091	#10 - #12	--	Yellow
PG4092	#8	49	Red
PG4093	#6	7	Blue
PG4094	#4	8	Gray
PG4095	#3	9	White
PG4096	#2	10	Brown

Copper C-Tap Connectors				
Catalog Number	Wire Size Cu Str. AWG		Die Index # (Color)	# of Crimps
	Run	Tap		
YC10L12	14	16-14	49 (Red)	1
	12	16-14		
	10	16		
YC8L12	10	10	7 (Blue)	1
	8	12		
YC6L12	8	10-8	8 (Grey)	1
	6	12-10		
YC4L12	6	8-6	10 (Brown)	2
	5, 4	12-8		

Specifications:

Catalog Number: Y122CMR
 Size: 10.38" x 3.00" x 1.00"
 Weight: 1.3 lbs
 Die Style: Rotating Die Wheel
 Warranty: 5 year limited warranty

Accessories:

Die Inspection Gages are available and sold separately. See table to the left for information.

Y122CMR Tools with select connectors For #12 to #2 AWG Stranded, Solid, and Flex

Tool Series: Y122CMR Kits

- Overmolded comfort grip handles
- Easy groove identification with color coded dies
- UL Listed/CSA Certified connections when used with recommended BURNDY terminals/splices
- Die index embossment for all 6 wire ranges
- Two kits available that include popular connectors in a sturdy metal carrying case
- Y122CMRKIT offers select LONG barrel connectors
- Y122CMRCKIT offers select STANDARD barrel connectors



Y122CMRKIT shown

Y122CMRKIT Contents: (all connectors are LONG Barrel)		
Catalog Number	Description	Qty
Y122CMR	HYTOOL™ Full Cycle Ratchet Tool	1
Y1MRKITCASE	Metal Case for Tool and Connectors	1
YAV102TC14	#10 Sol & Str, 1/4" Stud, 2 Holes	15
YAZV10TC14	#10 Sol & Str, 1/4" Stud, 1 Hole	15
YAZV102TC14	#10 AWG, 1/4" Stud, 2 Holes	15
YAZ8CTC14	#8 AWG, 1/4" Stud, 1 Hole	15
YAZ8C2TC38	#8 AWG, 3/8" Stud, 2 Holes	15
YAZ6CTC14	#6 AWG, 1/4" Stud, 1 Hole	15
YAZ6C2TC38SL	#6 AWG, 3/8" Stud, 2 Slotted Holes	15
YAZ6C2TC14	#6 AWG, 1/4" Stud, 2 Holes	15
YAZV6C2TC14FX	#6 Code & Flex, 1/4" Stud, 2 Holes	15
YAZ6C2TC38	#6 AWG, 3/8" Stud, 2 Holes	15
YAZ4C2TC38	#4 AWG, 3/8" Stud, 2 Holes	15
YAZ3C2TC14	#3 AWG, 1/4" Stud, 2 Holes	15
YAZ3C2TC38SL	#3 AWG, 3/8" Stud, 2 Slotted Holes	15
YAZ2C2TC38	#2 AWG, 3/8" Stud, 2 Holes	15
YAZ2C2TC38SL	#2 AWG, 3/8" Stud, 2 Slotted Holes	15
YAZV2C2TC14FX	#2 Code & Flex, 1/4" Stud, 2 Holes	15
Y122CMRSOMI	Safety Operating & Maintenance Instructions	1

Accessories:

Die Inspection Gages are available and sold separately.
See Y122CMR catalog page for details.

Specifications:

Size:	18.00" x 7.50" x 2.00"
Weight:	13.7 lbs
Die Style:	Rotating Die Wheel
Warranty:	5 year limited warranty

Y122CMRCKIT Contents: (all connectors are STANDARD Barrel)		
Catalog Number	Description	Qty
Y122CMR	HYTOOL™ Full Cycle Ratchet Tool	1
Y1MRKITCASE	Metal Case for Tool and Connectors	1
YAV10T3	#10 Sol & Str, 1/4" Stud, 1 Hole	15
YA8CL	#8 AWG, #10 Stud, 1 Hole	15
YA8CL1	#8 AWG, 1/4" Stud, 1 Hole	15
YA6CL	#6 AWG, 1/4" Stud, 1 Hole	15
YAV6CLTC14FX	#6 AWG & Flex, 1/4" Stud, 1 Hole	15
YA4CL	#4 AWG, 1/4" Stud, 1 Hole	15
YAV4CLTC516FX	#4 AWG & Flex, 5/16" Stud, 1 Hole	15
YA2CL	#2 AWG, 5/16" Stud, 1 Hole	15
YAV2CLTC516FX	#2 AWG & Flex, 5/16" Stud, 1 Hole	15
YSV10	#10 Sol & Str Splice	15
YS8CL	#8 AWG Splice	15
YS6CL	#6 AWG Splice	15
YS4CL	#4 AWG Splice	15
YS2CL	#2 AWG Splice	15
Y122CMRSOMI	Safety Operating & Maintenance Instructions	1

Full Cycle Ratchet Hand-held Tool For #26 to #8 AWG Terminals/Splices

Full Cycle Ratchet Hand-held Tool For #26 to #8 AWG Terminals/Splices

Tool: M8ND

- Ratchet mechanism does not allow handles to open until full cycle is complete
- Fully protected ratchet mechanism
- Uses standard BURNDY N style dies (sold separately)
- Easy groove identification with color coded dies

For Use On:

#26 - #8 AWG Terminals/Splices

Terminal Types: YAD, BA-E, YAD-F, BA-EF, YAE, BA-ES, YAE-F, BA-EZ, YAE-Z, BA-EL, YAES, YAEV-H, YAEV-L, YAV, YAV-F, YAV-H, YAV-H-F

Splice Types: YSV, YSM, YSV-H, YRV-L



Models:

M8ND

Tool, #26 - #8 AWG

Specifications:

Weight:	1.8 lbs
Size:	10.88" x 2.00" x .88"
Die Style:	N
Cycles:	10,000
Warranty:	5 year limited warranty



M8ND shown with N8CT die set installed. (Dies sold separately.)

Mechanical Rotating Crimp Tool For #8 to #4/0 AWG Uninsulated (Bare) Terminals/Splices

Tool Series: MRC840

- Heat treated steel jaws
- Spring loaded mechanism locks die wheel into position
- Multiple crimp selection with rotatable die wheels
- Die index embossment for inspectability

For Use On:

MRC840

#8 - #4/0 AWG Copper Terminals/Splices
Types: YA, YA-L, YS, YS-L

MRC840AL

#8 - #4/0 AWG Aluminum Terminals/Splices
Types: YA-A, YS-A



Models:

MRC840
MRC840AL

Tool, #8 - 4/0 AWG Copper
Tool, #8 - 4/0 AWG Aluminum

Specifications:

Size:	26.00" x 8.00" x 1.50"
Weight:	8.3 lbs
Die Style:	Rotating Die Wheel
Warranty:	5 year limited warranty

Mechanical Compression Tool, Dieless
#8 Str. - 250 kcmil Copper; #8 Str. - 4/0 Str. Aluminum

Mechanical Compression Tool, Dieless
#8 Str. to 250 kcmil Copper; #8 Str. to 4/0 Str. Aluminum

Tool Series: MY28 / MY29

- Easy to adjust nest die with knurled steel knob and machine threads
- Rugged tool design with heavy duty forged steel with reinforced back and handles
- Bench mount adapter (sold separately) available

For Use On:

**MY293, MY293C (covered handles),
MY293CF (fully covered)**

- #8 Str. - 250 kcmil Copper commercial (code) cable
- 30 Navy - 250 Navy Copper Navy cable
- #8 Str. - 4/0 Str. Aluminum commercial (code) cable
- Types (Copper): YA, YA-L, YS-L
- Types (Aluminum): YA-A, YS-A

**MY2911, MY2911C (covered handles),
MY29UNIVERSALKIT (MY2911 tool, select connectors)**

- #8 Str. - 250 kcmil Copper commercial (code) cable
- 30 Navy - 250 Navy Copper Navy cable
- #8 Str. - 4/0 Str. Flexible copper mine machine cable
- Types (Copper): YA, YA-L, YS, YAV-FX, YS-L, YAV-L, YSV-L

MY28

- #8 Str. - 4/0 Str. Copper aircraft cable
- Types (Copper): YAV-L, YSV-L

MY284

- #8 Str. - 4/0 Str. Aluminum aircraft cable
- Types (Aluminum): YAV-A-L, YSV-A-L, YAV-A-R

MY286

- #8 Str. - 2/0 Str. Copper aircraft cable (flexible)
- Types (Copper): Nylon Insulated: YAE-L, YAEV-RS, YAEV-H, YAEV-RH



Models:

(See For Use On)

Specifications:

Weight:	8.0 lbs
Size:	22.65" x 4.88" x 1.12"
Die Style:	Dieless
Cycles:	10,000
Warranty:	5 year limited warranty

Accessories:

BMYPCHMT: Bench Mount Adapter

Close-up of dieless mechanism



Full Cycle Ratchet Tool, Dieless Installs Service Entrance Splice Connectors #10-1/0 Str.

Tool: OH25

- Ratchet mechanism does not allow handles to open until full cycle is complete
- Easy, one-hand operation incrementally closes jaws with each handle stroke
- Spring-loaded comfort grip handles
- Forged steel jaws and stainless steel indenter



For Use On:

Conductor Range: #10 - 1/0 Str.

5/8" Service Entrance Sleeves:
INSULINK™ Type ES (insulated) #10 - 1/0 Str.
LINKIT™ Type YSU (bare) #8 - 1/0 Str.

5/8" Neutral Tension Sleeves
HYSPLICE™ Types:
YS-S, YCS-R, YDS-AT #4 - 1/0 Str.

HYPLUG™ AYP Type #6 - 1/0 Str.

Models:

OH25

Tool, #10 - 1/0 Str

Specifications:

Handle Force:	50 lbs max.
Force Developed:	6,000 lbs max.
Size:	12.25" x 3.75" x 1.50"
Weight:	2 lbs. 11 oz.
Die Style:	Dieless
Warranty:	5 year limited warranty

Accessories:

PT8504:

Go/No-Go Gauge; used to check crimp dimensions

POPPER™ HYTOOL™ Full Cycle Ratchet
Overhead/Underground Applications

Tool: OUR840

- Allows proper crimping of sleeves/terminations in underground applications
- Uses X dies for reduced handle force and W dies for fewer number of crimps
- UL Listed connections when used with BURNDY Listed connectors and color-coded X dies



For Use On:

Selected Applications:

Copper conductors #8 AWG - 250 kcmil
Aluminum conductors #8 AWG - 4/0 AWG

Models:

OUR840 Tool, #8 AWG - 250 kcmil

Copper Terminals & Splices					
Copper Wire Size	Connector Catalog Types	Die	Die Index # (Color)	# Crimps per Barrel Length	
				Std	Long
#8 AWG Str.	YA / YS 8C-	X8CRT	49 (Red)	1	2
#6 AWG Str. #5 AWG Str.	YA / YS 6C-, YA / YS 5C-	X5CRT	7 (Blue)	1	2
#4 AWG Str.	YA / YS 4C-	X4CRT	8 (Gray)	1	2
#2 AWG Str.	YA / YS 2C-	X2CRT	10 (Brown)	1	2
#1 AWG Str.	YA / YS 1C-	X1CRT	11 (Green)	1	2
1/0 AWG Str.	YA / YS 25-	X25RT	12 (Pink)	2	4
2/0 AWG Str.	YA / YS 26-	X26RT	13 (Black)	2	4
3/0 AWG Str.	YA / YS 27-	X27RT	14 (Orange)	3	6
4/0 AWG Str.	YA / YS 28-	X28RT	15 (Purple)	3	6
250 kcmil	YA / YS 29-	X29RT	16 (Yellow)	4	8

Aluminum Terminals & Splices				
Aluminum Wire Size	Connector Catalog Types	Die	Die Index # (Color)	# Crimps
#8 AWG Str.	YA / YS 8CA-	X8CART	374 (Blue)	2
#6 AWG Str.	YA / YS 6CA-	X6CART	346 (Gray)	2
#4 AWG Str.	YA / YS 4CA-	X4CART	375 (Green)	3
#2 AWG Str.	YA / YS 2CA-	X2CART	348 (Pink)	4
#1 AWG Str.	YA / YS 1CA-	X1CART	471 (Gold)	3
1/0 AWG Str.	YA / YS 25A-	X25ART	296 (Tan)	4
2/0 AWG Str.	YA / YS 26A-	X26ART	297 (Olive)	4
3/0 AWG Str.	YA / YS 27A-	X27ART	467 (Ruby)	4
4/0 AWG Str.	YA / YS 28A-	X28ART	298 (White)	6

Specifications:

Handle Force: 8 lbs max.
Force Developed: 8,000 lbs max.
Die Style: W and X
Size: 13.00" x 3.75" x 1.50"
Weight: 2 lbs. 14 oz.
Warranty: 5 year limited warranty

Accessories:

- XOH25:** Nest/Indenter die set for OUR840
W28K: Cutter die for #4 - 4/0 ACSR, Copper, Aluminum
PT4583: Leather Holster made from top grain cowhide saddle leather with large grommet
OUR840WC: Metal carrying case with die tray - holds OUR840 tool and up to eleven (11) X dies (sold separately)

HYTOOL™ Hand-Operated Crimper Installs full range of connectors #14 AWG to 500 kcmil

Tool Series: MD6

- Uses W & X style dies
- Spring loaded positive lock die retainer buttons
- Multiple variations available

For Use On:

Copper, Aluminum, ACSR, Steel, Copperweld, Alumoweld, 6201, 5005, Compressed, and Compact Conductors

Taps:

Copper: #10 sol. to 2/0 str.

Aluminum & ACSR: #14 sol. to 4/0 ACSR

Stirrups:

#6 to 4/0 ACSR

Overhead Full Tension Deadends, Full Tension Splices and Terminals:

#10 str. to 4/0 ACSR

Terminals & Splices*:

#8 to 500 kcmil Copper Stranded (YA, YA-L, YS, YS-L)

#8 to 350 kcmil Copper Flex

#8 to 350 kcmil Aluminum (YA-A, YS-A)

* NOTE: Sizes 250-500 kcmil are not recommended with MD6 & MD7 Series due to high handle force. Suggest PATMD-LW Series.

Specifications:

Crimp Force:	4.5 Tons
Life Cycle:	Tested over 90,000 cycles with no adjustments or part replacement
Length:	25.50" x 4.50" x 2.00"
Weight:	6.0 lbs
Die Style:	W and X
Warranty:	5 year limited warranty



Models:

MD6

Permanent BG (5/8) and D3 grooves; with WO die (sold separately) can install the CABLELOK CRIMPIT™ and HYCRIMP™ tap connectors

MD68

Permanent O and D3 grooves; with WBG die (sold separately) can install the CABLELOK CRIMPIT™ and HYCRIMP™ tap connectors

MD66 MD637

Snub-nose, permanent D3 groove only
Permanent 161, 162, 163, 171 dies in jaw (J, M & P, T & X)

MD638 MD64

Permanent K, BG, C dies in jaw
Permanent BG (5/8) and D3 grooves; straight fiberglass handles 24" long; fiberglass rated 100kV per foot for 5 min.

MD614

Permanent BG (5/8) and D3 grooves; straight fiberglass handles 19" long with grips; fiberglass rated 100kV per foot for 5 min.

MD612

Permanent O and D3 grooves; straight fiberglass handles 24" long; fiberglass

Accessories:

WBG:

Common die set for MD68, MD612

WO:

Common die set for MD6, MD64, MD614

WDIETREE:

W die holder for 6 die sets

HYTOOL™ Hand-Operated Crimper
Installs full range of connectors #14 AWG to 500 kcmil

Tool Series: MD7

- Uses W & X style dies
- Ergonomic, one-piece composite polymer handles
- Nickel plated jaws and jaw links

For Use On:

Copper, Aluminum, ACSR, Steel, Copperweld, Alumoweld, 6201, 5005, Compressed, and Compact Conductors

Taps:

Copper: #10 sol. to 2/0 str.

Aluminum & ACSR: #14 sol. to 4/0 ACSR

Stirrups:

#6 to 4/0 ACSR

Overhead Full Tension Deadends, Full Tension Splices and Terminals:

#10 str. to 4/0 ACSR

Terminals & Splices*:

#8 to 500 kcmil Copper Stranded (YA, YA-L, YS, YS-L)

#8 to 350 kcmil Copper Flex

#8 to 350 kcmil Aluminum (YA-A, YS-A)

* **NOTE:** Sizes 250-500 kcmil are not recommended with MD6 & MD7 Series due to high handle force. Suggest PATMD-LW Series.



Models:

MD7

Permanent BG (5/8) and D3 grooves; with WO die (sold separately) can install the CABLELOK CRIMPIT™ and HYCRIMP™ tap connectors

MD78

Permanent O and D3 grooves; with WBG die (sold separately) can install the CABLELOK CRIMPIT™ and HYCRIMP™ tap connectors

MD76

Snub-nose, permanent D3 groove only

Specifications:

Output Force:	4.5 Tons
Size:	25.00" x 4.50" x 2.00"
Weight:	7.0 lbs.
Die Style:	W and X
Life Cycle:	Tested over 90,000 cycles with no adjustments or part replacement
Warranty:	5 year limited warranty

Accessories:

WBG:	Common die set for MD78
WO:	Common die set for MD7, MD76
WDIETREE:	W die holder for 6 die sets

POSI-PRESS™ Hand-Operated Crimper Hand-Operated Full Cycle Ratchet Tool

Tool Series: MD7 Ratchet

- Full stroke ratchet mechanism
- Ergonomical one-piece composite polymer handles
- Uses W & X style dies

For Use On:

Copper Lugs/Splices #8 - 500 kcmil:

Types: YA, YA-L, YA-L-TC, YA-L-NT, YS-L, YS, YST, YA-TC

Copper Lugs/Splices #8 - 350 kcmil Flex

Types: YAV-L-TC-FX, YA-LB, YA-TC-FXB, YSV-L, YAV-L-NT-FX, YAV-L-FX, YAV-FXB

Copper Battery Lugs #8 - 350 kcmil Flex

Type: YAG-TC-LD

Thin Wall C-Taps #12 - 3/0 AWG

Type: YC-L

Specifications:

Crimp Force:	4.5 Tons
Length:	26.00" x 4.50" x 2.00"
Width:	8.00" at handles; 4.50" at jaws
Die Style:	W and X
Handle Material:	Reinforced composite polymer
Warranty:	5 year limited warranty



Models:

MD734R	POSI-PRESS™ Full Cycle Ratchet Tool
MD734RC	MD734R tool with EPDM rubber covering
MD734RKIT1	MD734R tool, metal carrying case and all dies for #8 - 500 kcmil copper HYDENT™ and C-Taps for #12 - 3/0 AWG
MD734	Supplied <u>without</u> the ratchet mechanism
MD734KIT1	MD734 tool (no ratchet mechanism), metal carrying case and all dies for #8 - 500 kcmil copper HYDENT™ and C-Taps for #12 - 3/0 AWG

Accessories:

PT49521:	Metal carry case (sold separately)
PT4925:	Canvas bag (sold separately)
WDIETREE:	W die holder for 6 sets of dies (sold separately)

OEM Pneumatic Press
Installs #8 to 4/0 AWG

Tool Series: OEM840NCP

- Customizable clear safety guard for left, right, or front feed cable entry
- Guarded foot switch
- Adjustable connector locator
- Cycle counter
- Accommodates UM, U and W dies

For Use On:

#8 - 4/0 AWG Copper Terminals
Type: YA, YA-L, YAD-M, YAV, YAV-L



Models:

OEM840NCP OEM Pneumatic Press (press only*)

*Requires U / UM or W Die Holder Assembly for use. Sold separately, see below.

Connector and Die Selection Matrix						
Wire Size	YAD-M Connectors		YA and YA-L Connectors		YAV and YAV-L Connectors	
	UM Dies (DLO Copper)		U Dies (Code)	W Dies (Code)	U Dies (Code)	W Dies (Code)
	Indenter	Nest	Copper	Copper	Copper	Copper
#8 AWG	UMA	UM8CN	U8CRT	W8CRT	U8CRT	W8CRT
#6 AWG	UMB	UM6CN	U5CRT	W5CRT	U5CRT	W5CRT
#4 AWG	UMB	UM4CN	U4CRT	W4CRT	U4CRT	W4CRT
#2 AWG	UMB	UM2CN	U2CRT	W2CRT	U2CRT	W2CRT
1/0 AWG	UMC	UM25N	U25RT	W25RT	U25RT	W25RT
2/0 AWG	UMC	UM26N	U26RT	W26RT	U26RT	W26RT
3/0 AWG	UMC	UM27N	U27RT	W27RT	U27RT	W27RT
4/0 AWG	UMC	UM28N	U28RT	W28RT	U28RT	W28RT



UM Nest/Indenter



UM Crimped Terminal

Specifications:

Weight: 61.0 lbs
 Size: 22.75" x 12.38" x 10.25"
 (18.56" L with air gauge)
 Die Style: UM, U, and W
 Crimp Speed: 3 seconds (approximately)
 Life Cycles: 2.5 M cycles (min)
 Air Pressure: 90-100 PSI
 Connector Port: 3/8" NPT female thread
 Warranty: 2 year limited warranty

Accessories:

PT50024685: U / UM Die Holder Assembly (sold separately)
 PT50024683: W Die Holder Assembly (sold separately)
 PT50024605: Front Safety Guard

See Connector and Die Selection Matrix above.
 All dies, nest and indenters are sold separately.

Pneumatic Bench Top Press Terminates Small Terminals on Mylar Tape (#22-#10 AWG)

Tool: OEM175TFM

- Auto feed mechanism; High volume crimping
- 2-stage ram for accurate conductor placement
- Foot actuated pedal included
- Clear plastic safety guard with interlock switch to prevent access into crimp area during operation
- Quick change over
- Emergency release switch

For Use On:

#22 - #10 AWG Small HYDENT™ Ring and Fork Tongue Terminals on Mylar Tape Reels
Bare (non-insulated)
requires TFM2214B & TFM1210B dies*
Vinyl and Nylon Insulated
requires TFM2218NV, TFM1614NV & TFM1210NV dies*

*Dies sold separately

Current Terminals Available on Mylar Tape Reels
(others may be available upon request)



Models:

OEM175TFM

Pneumatic Press, #22 - 10 AWG

Specifications:

Weight: 58 lbs
Size: 36" W x 24" D x 20" H
Die Style: TFM-B and TFM-NV (sold separately)
Air Pressure: 90 - 100 PSI
Warranty: 2 year limited warranty

Wire Size	Stud Size	Rings			Standard Forks			Locking Forks	Flanged Forks	
		Non-Insulated	Vinyl	Nylon	Non-Insulated	Vinyl	Nylon	Vinyl	Vinyl	Nylon
#22 - #16	2			YAE18N27M		BA16EF2M			BA16EZ2M	YAE18Z1M
	4	YAD184M	BA16E4M	YAE18N26M						
	6	YAD186M	BA16E6M	YAE18N21M	YAD186FM	BA16EF6M	YAE18G43FM	BA16EL6M	BA16EZ6M	YAE18Z2M
	8	YAD188M	BA16E8M	YAE18N1M		BA16EF8M	YAE18N57FM	BA16EL8M	BA16EZ8M	YAE18Z3M
	10	YAD1810M	BA16E10M	YAE18NM		BA16EF10M		BA16EL10M	BA16EZ10M	YAE18Z4M
	1/4	YAD1814M	BA16E14M	YAE18N2M						
	5/16			YAE18N3M						
#16 - #14	6	YAD146M	BA14E6M	YAE14N43M	YAD146FM		YAE14N76FM	BA14EL6M	BA14EZ6M	YAE14Z2M
	8	YAD148M	BA14E8M	YAE14N1M		BA14EF8M	YAE14N77FM	BA14EL8M	BA14EZ8M	YAE14Z3M
	10	YAD1410M	BA14E10M			BA14EF10M	YAE14N78FM	BA14EL10M	BA14EZ10M	YAE14Z4M
	1/4	YAD1414M	BA14E14M	YAE14N2M						
	5/16		BA14E516M	YAE14N3M						
#10 - #12	6	YAD106M	BA10E6M	YAE10N5M	YAD106FM	BA10EF6M		BA10EL6M		YAE12Z2M♦
	8	YAD108M	BA10E8M	YAE10N11M	YAD108FM	BA10EF8M		BA10EL8M	BA10EZ8M	YAE12Z3M♦
	10	YAD1010M	BA10E10M	YAE10NM	YAD1010FM	BA10EF10M		BA10EL10M	BA10EZ10M	YAE12Z4M♦
	1/4	YAD1014M	BA10E14M	YAE10N3M	YAD1014FM					
	5/16	YAD10516M		YAE10N2M						
	3/8	YAD1038M								

♦ Wire Size #14 - #12

DIE PROFILES

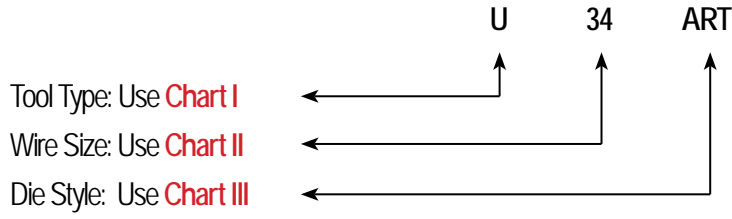
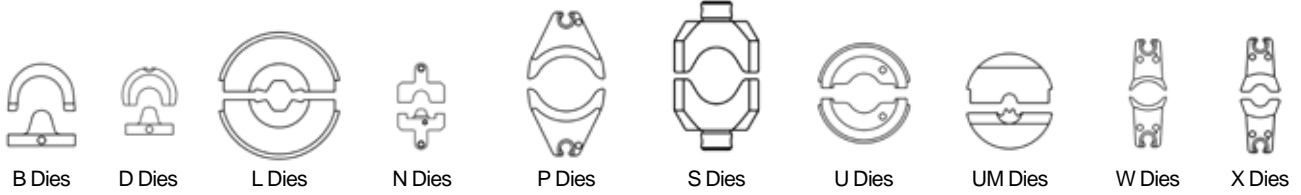

CHART I - Tool Type

- B** = Y34BH
- D** = Y29BH
- L** = 60 Series
- N** = M8ND
- P** = 46 Series
- S** = Y45
- U** = 35 and 750 Series, 46 Series w/PUADP1 U-die Adapter
- UM** = OEM840NCP, 750 Series, 46 Series w/PUADP1 U-die Adapter
- W** = MD and PATMD Series, PAT500SJ, PAT600
- X** = MD6 and MD7 Series, OUR840

CHART II - Wire Size

- 12** = #12 AWG
- 10** = #10 AWG
- 8C** = #8 AWG
- 6C** = #6 AWG
- 5C** = #5 AWG
- 4C** = #4 AWG
- 3C** = #3 AWG
- 2C** = #2 AWG
- 1C** = #1 AWG
- 25** = 1/0
- 26** = 2/0
- 27** = 3/0
- 28** = 4/0
- 29** = 250 kcmil
- 30** = 300 kcmil
- 31** = 350 kcmil
- 32** = 400 kcmil
- 34** = 500 kcmil
- 36** = 600 kcmil
- 39** = 750 kcmil
- 44** = 1000 kcmil

Or **INDEX NUMBER**: Example U312 = **312** Die Index

CHART III - Die Style

- A** = Aluminum
- R** = Round (circumferential)
- T** = Twin Die (both halves)

60 Ton Dies
HPS/Fargo-equivalent Dies; CD Index, Circumferential



BURNDY Die Catalog Number	Conductor Code Name	Conductor Size	Typical HPS/Fargo Connectors	
			UNI-GRIP® Splice	UNI-GRIP® Deadend
07CD60	Peony	300.0 AAC	C150707	C010707
	Tulip	336.4 AAC	C150707	C010707
	Daffodil	350.0 AAC	C150707	C010707
	no name (0.595-0.680 dia.)	281.4-312.8 AAAC	AB150707	AB010707
	Owl	266.8 ACSR 6/7 Str.	A150709	A010709
	Partridge	266.8 ACSR 26/7 Str.	A150710	A010710
08CD60	Canna	397.5 AAC	C150808	C010808
	Four-O'Clock	400.0 AAC	C150808	C010808
	no name (0.681-0.765 dia.)	394.5-419.6 AAAC	AB150808	AB010808
	Ostrich	300.0 ACSR 26/7 Str.	A150811	A010811
	Merlin	336.4 ACSR 18/1 Str.	A150812	A010812
	Linnet	336.4 ACSR 26/7 Str.	A150813	A010813
	Chickadee	397.5 ACSR 18/1 Str.	A150815	A010815
09CD60	Goldentuft	450.0 AAC	C150909	C010909
	Yarrow	450.0 AAC	C150909	C010909
	Cosmos	477.0 AAC	C150909	C010909
	Syringa	477.0 AAC	C150909	C010909
	Zinnia	500.0 AAC	C150909	C010909
	Hyacinth	500.0 AAC	C150909	C010909
	Ganzania	550.0 AAC	C150909	C010909
	no name (0.772-0.855 dia.)	465.4-503.6 AAAC	AB150909	AB010909
	Oriole	336.4 ACSR 30/7 Str.	A150914	A010914
	Brant	397.5 ACSR 24/7 Str.	A150916	A010916
	Ibis	397.5 ACSR 26/7	A150917	A010917
	Pelican	477.0 ACSR 18/1 Str.	A150919	A010919
	Flicker	477.0 ACSR 24/7 Str.	A150920	A010920
	10CD60	Dahlia	556.5 AAC	C151010
Mistletoe		556.5 AAC	C151010	C011010
Meadowsweet		600.0 AAC	C151010	C011010
Orchid		636.0 AAC	C151010	C011010
Heuchera		650.0 AAC	C151010	C011010
no name (0.856-0.950 dia.)		545.0-657.3 AAAC	AB151010	AB011010
Hawk		477.0 ACSR 26/7 Str.	A1510211	A0110211

60 Ton Dies
HPS/Fargo-equivalent Dies; CD Index, Circumferential
(Continued)



BURNDY Die Catalog Number	Conductor Code Name	Conductor Size	Typical HPS/Fargo Connectors	
			UNI-GRIP® Splice	UNI-GRIP® Deadend
10CD60 (Continued)	Osprey	556.5 ACSR 18/1 Str.	A151023	A011023
	Parakeet	556.5 ACSR 24/7 Str.	A151024	A011024
	Dove	556.5 ACSR 26/7 Str.	A151025	A011025
	Swift	636.0 ACSR 36/1 Str.	A151030	A010030
	Kingbird	636.0 ACSR 18/1 Str.	A151031	A010031
11CD60	Verbena	700.0 AAC	C151111	C011111
	Flag	700.0 AAC	C151111	C011111
	Violet	715.5 AAC	C151111	C011111
	Nasturtium	715.5 AAC	C151111	C011111
	Petunia	750.0 AAC	C151111	C011111
	Cattail	750.0 AAC	C151111	C011111
	Arbutus	795.0 AAC	C151111	C011111
	Lilac	795.0 AAC	C151111	C011111
	Fuchsia	800.0 AAC	C151111	C011111
	Heliotrope	800.0 AAC	C151111	C011111
	no name (0.940-1.036 dia.)	739.8-740.8 AAAC	AB151111	AB011111
	Hen	477.0 ACSR 30/7 Str.	A151122	A011122
	Eagle	556.5 ACSR 30/7 Str.	A151126	A011126
	Peacock	605.0 ACSR 24/7 Str.	A151127	A011127
	Squab	605.0 ACSR 26/7 Str.	A151128	A011128
	Rook	636.0 ACSR 24/7 Str.	A151132	A011132
	Grosbeak	636.0 ACSR 26/7 Str.	A151133	A011133
	Flamingo	666.6 ACSR 24/7 Str.	A151136	A011136
	Gannett	666.6 ACSR 26/7 Str.	A151137	A011137
	Stilt	715.5 ACSR 24/7 Str.	A151138	A011138
Coot	795.0 ACSR 36/1 Str.	A151141	A011141	
12CD60	Anemone	874.5 AAC	C151212	C011212
	Crocus	874.5 AAC	C151212	C011212
	Cockscomb	900.0 AAC	C151212	C011212
	Snapdragon	900.0 AAC	C151212	C011212
	Magnolia	954.0 AAC	C151212	C011212
	Goldenrod	954.0 AAC	C151212	C011212
	no name (1.026-1.131 dia.)	833.6-932.6 AAAC	AB151212	AB011212
	Teal	605.0 ACSR 30/19 Str.	A151229	A011229
	Egret	636.0 ACSR 30/19 Str.	A151234	A011234

60 Ton Dies
HPS/Fargo-equivalent Dies; CD Index, Circumferential
(Continued)



BURNDY Die Catalog Number	Conductor Code Name	Conductor Size	Typical HPS/Fargo Connectors	
			UNI-GRIP® Splice	UNI-GRIP® Deadend
12CD60 (continued)	Starling	715.5 ACSR 26/7 Str.	A151239	A011239
	Tern	795.0 ACSR 45/7 Str.	A151242	A011242
	Cuckoo	795.0 ACSR 24/7 Str.	A151243	A0112431
	Condor	795.0 ACSR 54/7 Str.	A1512441	A0112441
	Drake	795.0 ACSR 26/7 Str.	A1512451	A0112451
	Ruddy	900.0 ACSR 45/7	A151247	A011247
	Catbird	954.0 ACSR 36/1 Str.	A151249	A011249
13CD60	Hawkweed	1000.0 AAC 37 Str.	C151313	C011313
	Camelia	1000.0 AAC 61 Str.	C151313	C011313
	Bluebell	1033.5 AAC 37 Str.	C151313	C011313
	Larkspur	1033.5 AAC 61 Str.	C151313	C011313
	Marigold	1113.0 AAC 61 Str.	C151313	C011313
	no name (1.140-1.235 dia.)	1000.0-1127.0 AAAC	AB151313	AB011313
	Mallard	795.0 ACSR 30/19 Str.	A151346	A011346
	Canary	900.0 ACSR 54/7 Str.	A151348	A011348
	Rail	954.0 ACSR 45/7 Str.	A151350	A011350
	Cardinal	954.0 ACSR 54/7 Str.	A1513511	A011351
	Ortolan	1033.5 ACSR 45/7 Str.	A151353	A011353
14CD60	Hawthorn	1192.5 AAC 61 Str.	C151414	C011414
	Narcissus	1272.0 AAC 61 Str.	C151414	C011414
	no name (1.236-1.330 dia.)	1172.0-1300.0 AAAC	AB151414	AB011414
	Curlew	1033.5 ACSR 54/7 Str.	A151454	A011454
	Bluejay	1113.0 ACSR 45/7 Str.	A151455	A011455
	Finch	1113.0 ACSR 54/19 Str.	A151456	A011456
	Bunting	1192.5 ACSR 45/7 Str.	A151457	A011457
15CD60	Columbine	1351.5 AAC 61 Str.	AC151515	AC011515
	Carnation	1431.0 AAC 61 Str.	AC151515	AC011515
	Gladiolus	1510.5 AAC 61 Str.	AC151515	AC011515
	no name (1.331-1.425 dia.)	1361.0-1500.0 AAAC	AB151315	AB011515
	Grackle	1192.5 ACSR 54/19 Str.	A151558	A011558
	Bittern	1272.0 ACSR 45/7 Str.	A1515591	A0115591
	Pheasant	1272.0 ACSR 54/19 Str.	A151560	A011560
	Dipper	1351.5 ACSR 45/7 Str.	A151561	A011561
	Martin	1351.5 ACSR 54/19 Str.	A151562	A011562

60 Ton Dies
HPS/Fargo-equivalent Dies; CD Index, Circumferential
(Continued)



BURNDY Die Catalog Number	Conductor Code Name	Conductor Size	Typical HPS/Fargo Connectors	
			UNI-GRIP® Splice	UNI-GRIP® Deadend
16CD60	Coreopsis	1590.0 AAC 61 Str.	C151616	C011616
	Dogwood	1590.0 AAC 91 Str.	C151616	C011616
	no name (1.426-1.520 dia.)	1534.0-1703.0 AAAC	AB151616	AB011616
	Bobolink	1431.0 ACSR 45/7 Str.	A151663	A011663
	Lapwing	1590.0 ACSR 45/7 Str.	A151667	A011667
17CD60	Jessamine	1750.0 AAC 61 Str.	C151717	C011717
	Falcon	1590.0 ACSR 54/19 Str.	A1517681	A0117681
	Chukar	1780.0 ACSR 84/19 Str.	A151769	A011769
	Seahawk	1869.0 ACSR 68/7 Str.	A151770	A011717



Top: close up of marking on Fargo splice requiring 12CD die index.

Bottom: Fargo splice requiring 12CD die index.



60 Ton Dies
 HPS/Fargo-equivalent Dies
 SH Index, Hexagonal
 AH Index, Hexagonal



Two Die Sets Required (sold separately)		Conductor Code Name	Conductor Size	Typical HPS/Fargo Connectors	
BURNDY Catalog # Aluminum Die	BURNDY Catalog # Steel Die			2-Die Splice	2-Die Deadend
75AH60	75SH60	Pigeon	3/0 ACSR 6/1 Str.	TJA7829	SEDA7829
76AH60	75SH60	Penguin	4/0 ACSR 6/1 Str.	TJA7929	SEDA7929
	74SH60	Waxwing	266.8 ACSR 18/1 Str.	TJA1102	SEDA1102
	76SH60	Partridge	266.8 ACSR 26/7 Str.	TJA1109	SEDA1109
20AH60	74SH60	Merlin	336.4 ACSR 18/1 Str.	TJA1302	SEDA1302
	74SH60	Chickadee	397.5 ACSR 18/1 Str.	TJA1502	SEDA1502
	10SH60	Ostrich	300.0 26/7 Str.	TJA1209	SEDA1209
	10SH60	Linnet	336.4 ACSR 26/7 Str.	TJA1309	SEDA1309
	10SH60	Oriole	336.4 ACSR 30/7 Str.	TJA1313	SEDA1313
	10SH60	Brant	397.5 ACSR 24/7 Str.	TJA1508	SEDA1508
	10SH60	Ibis	397.5 ACSR 26/7 Str.	TJA1509	SEDA1509
	12SH60	Lark	397.5 ACSR 30/7 Str.	TJA1513	SEDA1513
24AH60	75SH60	Pelican	477.0 ACSR 18/1 Str.	TJA1802	SEDA1802
	75SH60	Osprey	556.5 ACSR 18/1 Str.	TJA2202	SEDA2202
	10SH60	Flicker	477.0 ACSR 24/7 Str.	TJA1808	SEDA1808
	10SH60	Parakeet	556.5 ACSR 24/7 Str.	TJA2208	SEDA2208
	12SH60	Hawk	477.0 ACSR 26/7 Str.	TJA1809	SEDA1809
	12SH60	Hen	477.0 ACSR 30/7 Str.	TJA1813	SEDA1813
	12SH60	Dove	556.5 ACSR 26/7 Str.	TJA2209	SEDA2209
27AH60	12SH60	Peacock	605.0 ACSR 24/7 Str.	TJA2408	SEDA2408
	12SH60	Squab	605.0 ACSR 26/2 Str.	TJA2409	SEDA2409
	12SH60	Rook	636.0 ACSR 24/7 Str.	TJA2508	SEDA2508
	12SH60	Grosbeak	636.0 ACSR 26/7 Str.	TJA2509	SEDA2509
	12SH60	Flamingo	666.6 ACSR 24/7 Str.	TJA2808	SEDA2808
	12SH60	Gannet	666.6 ACSR 26/7 Str.	TJA2809	SEDA2809
	14SH60	Eagle	556.5 ACSR 30/7 Str.	TJA2213	SEDA2213
	14SH60	Wood Duck	605.0 ACSR 30/7 Str.	TJA2413	SEDA2413
	14SH60	Teal	605.0 ACSR 30/19 Str.	TJA2417	SEDA2417
	14SH60	Scoter	636.0 ACSR 30/7 Str.	TJA2513	SEDA2513
	14SH60	Egret	636.0 ACSR 30/19 Str.	TJA2517	SEDA2517
30AH60	10SH60	Tern	795.0 ACSR 45/7 Str.	TJA3318	SEDA3318
	10SH60	Ruddy	900.0 ACSR 45/7 Str.	TJA3818	SEDA3818
	10SH60	Rail	954.0 ACSR 45/7 Str.	TJA4118	SEDA4118
	12SH60	Stilt	715.5 ACSR 24/7 Str.	TJA3008	SEDA3008
	12SH60	Cuckoo	795.0 ACSR 24/7 Str.	TJA3308	SEDA3308

60 Ton Dies
HPS/Fargo-equivalent Dies
SH Index, Hexagonal
AH Index, Hexagonal
(Continued)



Two Die Sets Required (sold separately)		Conductor Code Name	Conductor Size	Typical HPS/Fargo Connectors	
BURNDY Catalog # Aluminum Die	BURNDY Catalog # Steel Die			2-Die Splice	2-Die Deadend
30AH60 (Continued)	12SH60	Condor	795.0 ACSR 54/7 Str.	TJA3321	SEDA3321
	12SH60	Crane	874.5 ACSR 54/7 Str.	TJA3721	SEDA3721
	14SH60	Starling	715.5 ACSR 26/7 Str.	TJA3009	SEDA3009
	14SH60	Drake	795.0 ACSR 26/7 Str.	TJA3309	SEDA3309
	14SH60	Canary	900.0 ACSR 54/7 Str.	TJA3821	SEDA3821
	14SH60	Towhee	954.0 ACSR 48/7 Str.	TJA4119	SEDA4119
	14SH60	Cardinal	954.0 ACSR 54/7 Str.	TJA4121	SEDA4121
	16SH60	Redwing	715.5 ACSR 30/19 Str.	TJA3017	SEDA3017
34AH60	10SH60	Ortolan	1033.5 ACSR 45/7 Str.	TJA4418	SEDA4418
	12SH60	Bluejay	1113.0 ACSR 45/7 Str.	TJA4718	SEDA4718
	12SH60	Bunting	1192.5 ACSR 45/7 Str.	TJA4918	SEDA4918
	14SH60	Curlew	1033.5 ACSR 54/7 Str.	TJA4421	SEDA4421
	14SH60	Finch	1113.0 ACSR 54/19 Str.	TJA4724	SEDA4724
36AH60	12SH60	Bittern	1272.0 ACSR 45/7 Str.	TJA5118	SEDA5118
	12SH60	Dipper	1351.5 ACSR 45/7 Str.	TJA5218	SEDA5218
	12SH60	Bobolink	1431.0 ACSR 45/7 Str.	TJA5418	SEDA5418
	14SH60	Grackle	1192.5 ACSR 54/19 Str.	TJA4924	SEDA4924
	16SH60	Pheasant	1272.0 ACSR 54/19 Str.	TJA5124	SEDA5124
38AH60	16SH60	Martin	1351.5 54/19 Str.	TJA5224	SEDA5224
	16SH60	Plover	1431.0 54/19 Str.	TJA5424	SEDA5424
	12SH60	Nuthatch	1510.5 45/7 Str.	TJA5618	SEDA5618
40AH60	16SH60	Parrot	1510.5 54/19 Str.	TJA5624	SEDA5624
	12SH60	Lapwing	1590.0 45/7 Str.	TJA5718	SEDA5718



Above: close up of marking on Fargo splice requiring 14SH die index.



Left: Fargo splice requiring 30AH die index.

12 Ton U Dies* For 35 and 750 Tool Series; 46 Series with PUADP1 Adapter

* Non-tension U-type 12 ton dies for YA, YS, YA-A, YS-A style connectors

** Wide dies are intended for use on long barrel terminals and splices (YA/YS) only.

Die Sets sold separately; U Die Kits also available; see following page

Note: N/A = not applicable



U28RT Die Set

Wire Size	Copper	Copper Wide Die**	Aluminum
#8 AWG	U8CRT	U8CRTW	U8CABT
#6 AWG	U5CRT	U5CRTW	U6CABT
#4 AWG	U4CRT	U4CRTW	U4CABT
#3 AWG	U3CRT	U3CRTW	N/A
#2 AWG	U2CRT	U2CRTW	U2CABT
#1 AWG	U1CRT1	U1CRT1W	U1CART
1/0 AWG	U25RT	U25RTW	U25ART
2/0 AWG	U26RT	U26RTW	U26ART
3/0 AWG	U27RT	U27RTW	U27ART
4/0 AWG	U28RT	U28RTW	U28ART
250 kcmil	U29RT	N/A	U29ART
300 kcmil	U30RT		U30ART
350 kcmil	U31RT		U31ART
400 kcmil	U32RT		U32ART
500 kcmil	U34RT		U34ART
535 Flex	U38XRT		N/A
600 kcmil	U36RT		U36ART
750 kcmil	U39RT		U39ART2
777 Flex	U44XRT		N/A



U4CRTW Wide Die Set



CASEUDIES15 die box is available (sold separately) holding up to 15 "U" style (standard or wide) die sets; dies not included.

12 Ton U Die Kits
For 35 and 750 Tool Series;
46 Series with PUADP1 Adapter

UDIEKITCU and UDIEKITAL include 15 sets of "U" dies and die case. These stainless steel color coded dies are for crimping YA, YS, YA-A, and YS-A types of connectors, ranging from #6 AWG through 750 kcmil.

Note: N/A = not applicable

UDIEKITHYGRD



Wire Size	UDIEKITCU includes	UDIEKITAL includes
#8 AWG	N/A	N/A
#6 AWG	U5CRT	U6CABT
#4 AWG	U4CRT	U4CABT
#2 AWG	U2CRT	U2CABT
#1 AWG	U1CRT1	U1CART
1/0 AWG	U25RT	U25ART
2/0 AWG	U26RT	U26ART
3/0 AWG	U27RT	U27ART
4/0 AWG	U28RT	U28ART
250 kcmil	U29RT	U29ART
300 kcmil	U30RT	U30ART
350 kcmil	U31RT	U31ART
400 kcmil	U32RT	U32ART
500 kcmil	U34RT	U34ART
600 kcmil	U36RT	U36ART
750 kcmil	U39RT	U39ART2
Die Case	CASEUDIES15	CASEUDIES15

UDIEKITHYGRD includes 8 dies sets. Seven die sets are used to install the BURNDY® HYGROUND® irreversible compression grounding connectors; the U2CABT die set is for pre-crimping 1/2", 5/8" and 3/4" ground rods for increased rotational resistance. The UDIEKITHYGRD also includes the CASEUDIES8 die case.

UDIEKITHYGRD includes
UC, UO, U997, PU998, U1011, U1104, U1105, U2CABT (Ground rod pre-crimp die), and CASEUDIES8 die case

UM-Style Dies

For OEM840NCP up to 4/0;
35 and 750 Tool Series;
46 Series with PUADP1 Adapter

UM-style Nest and Indenter dies are specifically designed to work with the YAD lugs. The distinctive "M" crimping profile design straddles the brazed seam of the YAD-M and YAV-L series lugs to provide a consistent, long term, reliable connection. Accepts copper cable sizes from 8 AWG to 600 kcmil for DLO/Flex cable.

CNC machined from stainless steel, these dies are compatible with all BURNDY® tooling that accepts a "U" die envelope.

Sold individually or in a kit (UMDIEKIT) which has select dies/indenters covering #8 to 4/0 AWG in a plastic die case.



Copper Wire Size	Catalog Number (Indenter Dies)	Catalog Number (Nest Dies)	Crimps Lug Series
8 AWG DLO	UMA	UM8CN	YAD-M*, YAV-L
6 AWG DLO	UMB	UM6CN	YAD-M*, YAV-L
4 AWG DLO	UMB	UM4CN	YAD-M*, YAV-L
2 AWG DLO	UMB	UM2CN	YAD-M*, YAV-L
1/0 AWG DLO	UMC	UM25N	YAD-M*, YAV-L*
2/0 AWG DLO	UMC	UM26N	YAD-M*, YAV-L*
3/0 AWG DLO	UMC	UM27N	YAD-M*, YAV-L*
4/0 AWG DLO	UMC	UM28N	YAD-M*, YAV-L*
300 kcmil DLO	UME	UM30N	YAD-M*
350 kcmil DLO	UME	UM31N	YAD-M*
450 kcmil DLO	UME	UM33N	YAD-M*
600 kcmil DLO	UME	UM36N	YAD-M*

* Not UL Listed



Close up of "M"
Profile Crimp

UMDIEKIT Contents		
Catalog Number	Description	Quantity
UMA	Indenter #8 AWG	1
UMB	Indenter #6, #4, #2 AWG	1
UMC	Indenter 1/0-4/0	1
UM8CN	Nest #8 AWG	1
UM6CN	Nest #6 AWG	1
UM4CN	Nest #4 AWG	1
UM2CN	Nest #2 AWG	1
UM25N	Nest 1/0 AWG	1
UM26N	Nest 2/0 AWG	1
UM27N	Nest 3/0 AWG	1
UM28N	Nest 4/0 AWG	1
CASEUDIES15	UM Die Kit Case	1

W Dies
For MD/PATMD, 500, and 600 Tool Series

* These sizes (250 - 500) are not recommended for use with MD6 & MD7 Series tools due to high handle force.

** For PAT600 and Y500CTHS only.

*** Use of W249 will not produce a UL Listed connection.

Note: N/A = not applicable

Suitable for use on YA, YS, YA-A, YS-A type non-tension connectors.

Die Sets sold separately; W Die Kits also available; see following page



W25RT Die Set

Wire Size	Copper (-VT)	Copper (-RT)	Aluminum
#8 AWG	W8CVT	W8CRT	X8CART
#6 AWG	W5CVT	W5CRT	W161
#4 AWG	W4CVT	W4CRT	W162
#3 AWG	N/A	W3CRT	N/A
#2 AWG	W2CVT	W2CRT	W239
#1 AWG	W1CVT	W1CRT1	W163
1/0 AWG	W25VT	W25RT	W241
2/0 AWG	W26VT	W26RT	W245
3/0 AWG	W27VT	W27RT	W166
4/0 AWG	W28VT	W28RT	W660
250 kcmil	W29VT*	W29RT*	W249***
300 kcmil	W30VT*	W30RT*	N/A
350 kcmil	W31VT*	W31RT*	W31ART*
400 kcmil	W32VT*	W32RT*	N/A
450 kcmil	W33VT*	W33RT*	N/A
500 kcmil	W34VT*	W34RT*	N/A
600 kcmil	N/A	W36RT**	N/A

VT = "V" profile die for reduced handle force when using MD6/MD7 series tools; Twin die (includes both halves)
RT = Round die (circumferential); Twin die (includes both halves)



WDIETREE available (sold separately); holds up to 6 "W" style die sets (dies not included)



CASEWDIES die box available (sold separately); holds up to 12 "W" or "X" style die sets (dies not included)

W Die Kits For MD/PATMD, 500, and 600 Tool Series

* These sizes (250 - 500) are not recommended for use with MD6 & MD7 Series tools due to high handle force.

** Use of W249 will not produce a UL Listed connection.

Note: N/A = not applicable

Suitable for use on YA, YS, YA-A, YS-A type non-tension connectors.



CASEWDIES
included with die kits;
also sold separately
(dies not included)

Wire Size	WDIEKITCU for Copper includes	WDIEKITAL for Aluminum includes
#8 AWG	W8CRT	X8CART
#6 AWG	W5CRT	W161
#4 AWG	W4CRT	W162
#2 AWG	W2CRT	W239
#1 AWG	W1CRT1	W163
1/0 AWG	W25RT	W241
2/0 AWG	W26RT	W245
3/0 AWG	W27RT	W166
4/0 AWG	W28RT	W660
250 kcmil	W29RT*	W249**
350 kcmil	W31RT*	W31ART*
500 kcmil	W34RT*	N/A
Die Case	CASEWDIES	CASEWDIES

PATRIOT® 11 Ton, Scissor Action
Copper and Aluminum up to 4.00" O.D.
Hydraulic Self-Contained, 18V Lithium-Ion

Tool Series: PATCUT4

- Extra wide jaw opening
- Scissor action cutting jaws
- 355° head rotation
- Multi-position assist handle
- Includes 2 batteries, charger, and polymer carrying case
- EP Enhanced Power — tools accept 2.0, 3.0, 4.0, 5.0, and 6.0Ah Makita batteries

For Use On:

Maximum Cutting Capacity:

Copper and Aluminum: up to 4.00" O.D.

PATCUT4CUAL
with multi-position
assist handle



Models:

PATCUT4CUALLI with 3.0Ah battery
PATCUT4L5 with 5.0Ah battery

Specifications:

Output Force:	11 Tons
Tool Weight:	19.70 lbs (without battery)
Size:	24.31" X 3.26" X 15.33"
Operating Voltage:	18 V-DC Lithium-Ion
Recharge Time:	30 minutes (3.0Ah) 45 minutes (5.0Ah)
Warranty:	5 year limited warranty (excludes blades) Lifetime warranty on INFINITY DRIVE® 3 year on batteries and charger

Accessories:

BAT18VLI:	3.0Ah Li-Ion battery
BAT18V5AHLI:	5.0Ah Li-Ion battery
PATCHGRLI:	120V-AC Charger
PATCHGRLIDC:	12/24V-DC Charger
PT208620:	Lanyard

See Important Notes page at start of Section.

PATRIOT® 10 Ton, Latch Head
ACSR up to 2156 kcmil
Hydraulic Self-Contained, 18V Lithium-Ion

Tool Series: PATCUT2156

- 180° head rotation
- Durable hardened steel blades
- Specialized latch head for mid-span cuts
- Mechanical ram release with no power consumption
- Includes 2 batteries, charger, and case
- **EP Enhanced Power** — tools accept 2.0, 3.0, 4.0, 5.0, and 6.0Ah Makita batteries

For Use On:

Copper/Aluminum Cable:	up to 2"
ACSR:	up to 2156 kcmil
Ground Rod:	up to 3/4"
Rebar:	up to 5/8"
Soft Steel Bolts:	up to 3/4"
Standard Guy:	up to 9/16"
EHS Guy:	up to 9/16"



Models:

PATCUT2156LI	with 3.0Ah battery, hard case
PATCUT2156L5	with 5.0Ah battery, hard case
PATCUT2156LIPB	with 3.0Ah battery, pro bag
PATCUT2156L5PB	with 5.0Ah battery, pro bag

Specifications:

Output Force:	10 Tons
Tool Weight:	14.10 lbs (without battery)
Size:	16.50" x 13.50" x 3.38"
Operating Voltage:	18 V-DC Lithium-Ion
Recharge Time:	30 minutes (3.0Ah) 45 minutes (5.0Ah)
Warranty:	5 year limited warranty (excluding blades) Lifetime warranty on INFINITY DRIVE® 3 year on batteries and charger

Accessories:

BAT18VLI:	3.0Ah Li-Ion battery
BAT18V5AHLI:	5.0Ah Li-Ion battery
PATCHGRLI:	120V-AC Charger
PATCHGRLIDC:	12/24V-DC Charger
PT208620:	Lanyard
CUT200BLMVBL:	Replacement Moving Blade
CUT200BLSTA:	Replacement Fixed (Stationary) Blade

See Important Notes page at start of Section.

PATRIOT® 7 Ton, Latch Head
Copper/Aluminum up to 1.29" O.D.
Hydraulic Self-Contained, 18V Lithium-Ion

Tool Series: PATCUT129

- 180° head rotation
- Overmolded handle and ergonomic design
- One-handed operation for advance, retract and hold
- Latch head design for interference free closure for mid-span cuts
- Includes 2 batteries, charger, and case
- **EP Enhanced Power** — tools accept 2.0, 3.0, 4.0, 5.0, and 6.0Ah Makita batteries



For Use On:

Copper/Aluminum Cable:	up to 1.29"
ACSR:	up to 1113 kcmil
Ground Rod:	up to 5/8"
Rebar:	up to 1/2"
Soft Steel Bolts:	up to 5/8"
Standard Guy:	up to 1/2"
EHS Guy Strand:	up to 3/8"

Models:

PATCUT129LI	with 3.0Ah battery, hard case
PATCUT129L5	with 5.0Ah battery, hard case
PATCUT129LIPB	with 3.0Ah battery, pro bag
PATCUT129L5PB	with 5.0Ah battery, pro bag

Specifications:

Output Force:	7 Tons
Tool Weight:	9.85 lbs (without battery)
Size:	14.50" x 13.50" x 3.50"
Operating Voltage:	18 V-DC Lithium-Ion
Recharge Time:	30 minutes (3.0Ah) 45 minutes (5.0Ah)
Warranty:	5 year limited warranty (excluding blades) Lifetime warranty on INFINITY DRIVE® 3 year on batteries and charger

Accessories:

BAT18VLI:	3.0Ah Li-Ion battery
BAT18V5AHLI:	5.0Ah Li-Ion battery
PATCHGRLI:	120V-AC Charger
PATCHGRLIDC:	12/24V-DC Charger
PT208620:	Lanyard
PT10037388:	Replacement Moving Blade
PT10037384:	Replacement Fixed Blade

See Important Notes page at start of Section.

PATRIOT® 6 Ton, Latch Head
Copper/Aluminum up to 2.45" O.D.
Hydraulic Self-Contained, 18V Lithium-Ion

Tool Series: PATCUT245

- 180° head rotation
- Cuts up to 2.45" diameter copper/aluminum cable
- Specialized latch style cutting head for interference-free closure for mid-span work
- Ergonomic design, overmolded handle
- Includes 2 batteries, charger, and case
- EP Enhanced Power — tools accept 2.0, 3.0, 4.0, 5.0, and 6.0Ah Makita batteries

For Use On:

Copper/Aluminum Cable: Up to 2.45" O.D.

For Copper and Aluminum cable only. Do not cut steel, ground rod, rebar or guy wire.



Models:

PATCUT245LI	with 3.0Ah battery, hard case
PATCUT245L5	with 5.0Ah battery, hard case
PATCUT245LIPB	with 3.0Ah battery, pro bag
PATCUT245L5PB	with 5.0Ah battery, pro bag

Specifications:

Output Force:	6 Tons
Tool Weight:	12.20 lbs (without battery)
Size:	18.13" x 13.50" x 3.50"
Operating Voltage:	18 V-DC Lithium-Ion
Recharge Time:	30 minutes (3.0Ah) 45 minutes (5.0Ah)
Warranty:	5 year limited warranty (excluding blades) Lifetime warranty on INFINITY DRIVE® 3 year on batteries and charger

Accessories:

BAT18VLI:	3.0Ah Li-Ion battery
BAT18V5AHLI:	5.0Ah Li-Ion battery
PATCHGRLI:	120V-AC Charger
PATCHGRLIDC:	12/24V-DC Charger
PT208620:	Lanyard
PT10038657:	Replacement Moving Blade
PT10040663:	Replacement Fixed Blade

See Important Notes page at start of Section.

PATRIOT® 6 Ton, Scissor Action
Hydraulic Self-Contained, 18V Lithium-Ion

Tool Series: PAT500SJCUT

- Interchangeable scissor action crimping and cutting jaws
- 180° head rotation
- Uses W and X style dies with available crimping jaws
- Ergonomically balanced tool design
- Includes 2 batteries, charger, and polymer carrying case
- EP Enhanced Power — tools accept 2.0, 3.0, 4.0, 5.0, and 6.0Ah Makita batteries



For Use On: Maximum Cutting Capacity:

ACSR:	556.5 kcmil (26/7 Dove)
AAC:	636 kcmil
Copper:	350 kcmil soft drawn copper

Interchangeable Jaw Assemblies:

PATMD6LWJAW	Crimp jaw with BG and D3 grooves
PATMD68LWJAW	Crimp jaw with O and D3 grooves
PATMD66LWJAW	Crimp jaw with D3 groove only
PATMDXPJLWJAW	Crimp jaw with X, P, & J grooves
**PATMD430LWJAW	**Crimp jaw, Dieless for #4-3/0 AWG
PATMDCUTLWJAW	Cutting jaw with ACSR blades
PATMDCUTCLWJAW	Cutting jaw with CU/AL blades
PATMDCUTGLWJAW	Cutting jaw with GUY blades

**Dieless Jaw only for use on #4-3/0 AWG BURNDY® Overhead Distribution Families: YDS-RL, YDSR-RL, YDS-RLY, YDR-RL, YDRR-RL, YCS-RL, YCA-RL and YSS-R

Accessories:

BAT18VLI:	3.0Ah Li-Ion battery
BAT18V5AHLI:	5.0Ah Li-Ion battery
PATCHGRLI:	120V-AC Charger
PATCHGRLIDC:	12/24V-DC Charger
PATMD6LWJWCVR:	Jaw covers for PATMD6 and PATMD68 versions
PATMD66LWJWCVR:	Jaw covers for PATMD66 snub-nose versions
PT10074020:	Wrist strap
W28K:	Cutter Dies (cuts 4-4/0 Cu, Al, ACSR)
WDIETREE:	W-die holder for 6 die sets

Models:

PAT500SJCUTLI	with 3.0Ah battery
PAT500SJCUTL5	with 5.0Ah battery

Crimp/Cut Kits:

PAT500SJ6LICUTKIT1	Kit includes crimp head with BG & D3 grooves, cutter jaw with ACSR blades, 120V charger and 2 batteries (3.0Ah)
PAT500SJ68LICUTKIT1	Kit includes crimp head with O & D3 grooves, cutter jaw with ACSR blades, 120V charger and 2 batteries (3.0Ah)

Specifications:

Output Force:	6 Tons
Tool Weight:	10.10 lbs (without battery)
Size:	17.00" X 14.25" X 3.00"
Die Style:	W and X (with crimping jaws)
Operating Voltage:	18 V-DC Lithium-Ion
Recharge Time:	30 minutes (3.0Ah) 45 minutes (5.0Ah)
Warranty:	5 year limited warranty Lifetime warranty on INFINITY DRIVE® 3 year on batteries and charger

See Important Notes page at start of Section.

PATRIOT® IN-LINE® 6 Ton, Scissor Action Hydraulic Self-Contained, 18V Lithium-Ion

Tool Series: PATMDCUTLW

- Light weight, compact and ergonomic design
- Interchangeable scissor action crimping and cutting jaws
- Safety trigger lock and locking jaw tabs
- LED Worklight
- EP Enhanced Power — tools accept 2.0, 3.0, 4.0, 5.0, and 6.0Ah Makita batteries

Shown with
ACSR
Cutting Jaw



Interchangeable Jaws

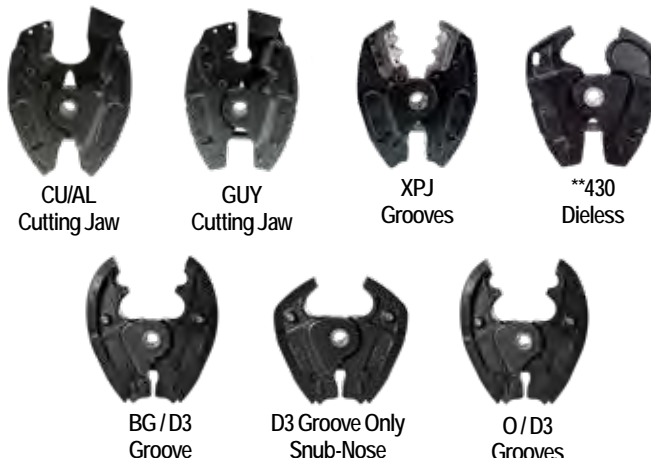

Cutting Capacities	ACSR (26/7)	Aluminum (AAC)	Copper (soft drawn)	Guy Wire (EHS)
ACSR Blade	556.5 kcmil	636 kcmil	350 kcmil	-
CU/AL Blade	-	636 kcmil	600 kcmil	-
GUY Blade	-	-	-	3/8"

Interchangeable Jaw Assemblies:

*PATMD6LWJAW	Crimp jaw with BG and D3 grooves
*PATMD68LWJAW	Crimp jaw with O and D3 grooves
*PATMD66LWJAW	Crimp jaw with D3 groove only
*PATMDXPJLWJAW	Crimp jaw with X, P & J grooves
*PATMD430LWJAW	Crimp jaw, Dieless, #4 AWG - 3/0 AWG
PATMDCUTLWJAW	Cutting jaw with ACSR blades
PATMDCUTCLWJAW	Cutting jaw with CU/AL blades
PATMDCUTGLWJAW	Cutting jaw with GUY blades

Models:

PATMDCUTLW:	ACSR Cutting Jaw, 3.0Ah batteries, AC charger
PATMDCUTLW5:	ACSR Cutting Jaw, 5.0Ah batteries, AC charger
PATMDCUTCLW:	CU/AL Cutting Jaw, 3.0Ah batteries, AC charger
PATMDCUTCLW5:	CU/AL Cutting Jaw, 5.0Ah batteries, AC charger
PATMD60003A1:	GUY Cutting Jaw, 3.0Ah batteries, AC charger
PATMD60005A1:	GUY Cutting Jaw, 5.0Ah batteries, AC charger

Customize a tool kit with up to 3 jaws and optional accessories.
Contact Customer Service at 1-800-346-4175.

Standard Crimp/Cut Kits are available supplied with both crimping and cutting jaws. (See separate pages in Crimpers Section)

*See battery crimper page for complete crimp specifications.

Accessories:

PATMDCUTACSRKIT:	ACSR Replacement Blades (2 per kit)
PATMDCUTCUALKIT:	CU/AL Replacement Blades (2 per kit)
PATMDCUTGUYKIT:	GUY Replacement Blades (2 per kit)
BAT18VLI:	Hi-capacity LI Makita battery (3.0Ah)
BAT18V5AHLI:	Hi-capacity LI Makita battery (5.0Ah)
PATCHGRLI:	120V-AC Makita charger
PATCHGRLIDC:	12/24V-DC Makita charger
W28K:	Cutter Dies (cuts 4-4/0 CU, AL, ACSR)
WDIETREE:	W-die holder for 6 die sets
CASEWDIES:	W-die case holder for 12 die sets
TOOLBAGMDLI:	Tool bag (included with tool)

Specifications:

Output Force:	6 Tons
Tool Weight:	5.50 lbs (without battery)
Length:	19.25"
Operating Voltage:	18 V-DC Lithium-Ion
Recharge Time:	
3.0Ah	30 minutes
5.0Ah	45 minutes
Warranty:	5 year limited warranty
	Lifetime warranty on INFINITY DRIVE®
	3 years on batteries and charger

See Important Notes page at start of Section.

PATRIOT® 6 Ton, Scissor Action
Hydraulic Self-Contained, 18V Lithium-Ion

Tool Series: PATMD-LW ACSR Kits

- Light weight, compact and ergonomic design
- Interchangeable scissor action crimping and cutting jaws
- Safety trigger lock and locking jaw tabs
- LED Worklight
- EP Enhanced Power — tools accept 2.0, 3.0, 4.0, 5.0, and 6.0Ah Makita batteries

Crimp Capacity		
Connector Type	Conductor Type	Range
Terminals & Splices	Copper	#8 AWG - 500 kcmil
Terminals & Splices	Flex Copper	#8 AWG - 350 kcmil
Terminals & Splices	Aluminum (AAC)	#8 AWG - 350 kcmil
Full-Tension	ACSR	#10 - 4/0 AWG
Taps	Copper	#10 - 2/0 AWG
Taps	AAC or ACSR	#14 - 4/0 AWG
Stirrups	ACSR	#6 - 4/0 AWG

ACSR Blade Cutting Capacity	
Conductor Type	Maximum Size
ACSR (26/7)	556.5 kcmil
Aluminum (AAC)	636 kcmil
Copper	350 kcmil

Interchangeable Jaw Assemblies:

- PATMD6LWJAW Crimp jaw with BG and D3 grooves
 PATMD68LWJAW Crimp jaw with O and D3 grooves
 PATMD66LWJAW Crimp jaw with D3 groove only
 PATMDCUTLWJAW Cutting jaw with ACSR blades

Accessories:

- PATMDCUTACSRKIT: ACSR Replacement Blades (2 per kit)
 BAT18VLI: Hi-capacity LI Makita battery (3.0Ah)
 BAT18V5AHLI: Hi-capacity LI Makita battery (5.0Ah)
 PATCHGRLL: 120V-AC Makita charger
 PATCHGRLLIDC: 12/24V-DC Makita charger
 W28K: Cutter Dies (cuts 4-4/0 CU, AL, ACSR)
 WDIETREE: W-die holder for 6 die sets
 CASEWDIES: W-die case holder for 12 die sets
 TOOLBAGMDLI: Tool bag (included with tool)



Shown with
ACSR
Cutting Jaw

**Interchangeable
Jaws**

BG / D3 Groove

O / D3 Groove

D3 Groove Only
Snub-Nose

Models*: all listed include AC Charger

- PATMD6LWWCJ: BG & D3, ACSR Cutter, 3.0Ah batteries
 PATMD68LWWCJ: O & D3, ACSR Cutter, 3.0Ah batteries
 PATMD66LWWCJ: D3 only, ACSR Cutter, 3.0Ah batteries

 PATMD6LW5WCJ: BG & D3, ACSR Cutter, 5.0Ah batteries
 PATMD68LW5WCJ: O & D3, ACSR Cutter, 5.0Ah batteries
 PATMD66LW5WCJ: D3 only, ACSR Cutter, 5.0Ah batteries

*Add DC suffix to catalog numbers for DC charger in place of AC charger.

Specifications:

- Output Force: 6 Tons
 Tool Weight: 5.50 lbs (without battery)
 Length:
 PATMD6LW 18.73"
 PATMD68LW 18.73"
 PATMD66LW 17.85"
 PATMDCUTLW 19.25"
 Die Style: W and X (with crimping jaws)
 Operating Voltage: 18 V-DC Lithium-Ion
 Recharge Time:
 3.0Ah 30 minutes
 5.0Ah 45 minutes
 Warranty: 5 year limited warranty
 Lifetime warranty on INFINITY DRIVE®
 3 years on batteries and charger

See Important Notes page at start of Section.

PATRIOT® IN-LINE® 6 Ton, Scissor Action Hydraulic Self-Contained, 18V Lithium-Ion

Tool Series: PATMD-LW CU/AL Kits

- Light weight, compact and ergonomic design
- Interchangeable scissor action crimping and cutting jaws
- Safety trigger lock and locking jaw tabs
- LED Worklight
- EP Enhanced Power — tools accept 2.0, 3.0, 4.0, 5.0, and 6.0Ah Makita batteries

Crimp Capacity		
Connector Type	Conductor Type	Range
Terminals & Splices	Copper	#8 AWG - 500 kcmil
Terminals & Splices	Flex Copper	#8 AWG - 350 kcmil
Terminals & Splices	Aluminum (AAC)	#8 AWG - 350 kcmil
Full-Tension	ACSR	#10 - 4/0 AWG
Taps	Copper	#10 - 2/0 AWG
Taps	AAC or ACSR	#14 - 4/0 AWG
Stirrups	ACSR	#6 - 4/0 AWG

CU/AL Blade Cutting Capacity	
Conductor Type	Maximum Size
Copper - Soft Drawn	600 kcmil
Aluminum (AAC)	636 kcmil

Interchangeable Jaw Assemblies:

PATMD6LWJAW	Crimp jaw with BG and D3 grooves
PATMD68LWJAW	Crimp jaw with O and D3 grooves
PATMD66LWJAW	Crimp jaw with D3 groove only
PATMDCUTCLWJAW	Cutting jaw with CU/AL blades

Accessories:

PATMDCUTCALKIT:	CU/AL Replacement Blades (2 per kit)
BAT18VLI:	Hi-capacity LI Makita battery (3.0Ah)
BAT18V5AHLI:	Hi-capacity LI Makita battery (5.0Ah)
PATCHGRLI:	120V-AC Makita charger
PATCHGRLLDC:	12/24V-DC Makita charger
W28K:	Cutter Dies (cuts 4-4/0 CU, AL, ACSR)
WDIETREE:	W-die holder for 6 die sets
CASEWDIES:	W-die case holder for 12 die sets
TOOLBAGMDLI:	Tool bag (included with tool)



Shown with
CU/AL
Cutting Jaw

Interchangeable Jaws



BG / D3 Groove

O / D3 Groove



D3 Groove Only
Snub-Nose

Models*: all listed include AC Charger

PATMD6LW5WCCJ:	BG & D3, CU/AL Cutter, 3.0Ah batteries
PATMD68LW5WCCJ:	O & D3, CU/AL Cutter, 3.0Ah batteries
PATMD66LW5WCCJ:	D3 only, CU/AL Cutter, 3.0Ah batteries
PATMD6LW5WCCJ:	BG & D3, CU/AL Cutter, 5.0Ah batteries
PATMD68LW5WCCJ:	O & D3, CU/AL Cutter, 5.0Ah batteries
PATMD66LW5WCCJ:	D3 only, CU/AL Cutter, 5.0Ah batteries

*Add DC suffix to catalog numbers for DC charger in place of AC charger.

Specifications:

Output Force:	6 Tons
Tool Weight:	5.50 lbs (without battery)
Length:	
PATMD6LW	18.73"
PATMD68LW	18.73"
PATMD66LW	17.85"
PATMDCUTCLW	19.25"
Die Style:	W and X (with crimping jaws)
Operating Voltage:	18 V-DC Lithium-Ion
Recharge Time:	
3.0Ah	30 minutes
5.0Ah	45 minutes
Warranty:	5 year limited warranty Lifetime warranty on INFINITY DRIVE® 3 years on batteries and charger

See Important Notes page at start of Section.

PATRIOT® 6 Ton, Scissor Action
Hydraulic Self-Contained, 18V Lithium-Ion

Tool Series: PATMD-LW GUY Kits

- Light weight, compact and ergonomic design
- Interchangeable scissor action crimping and cutting jaws
- Safety trigger lock and locking jaw tabs
- LED Worklight
- EP Enhanced Power — tools accept 2.0, 3.0, 4.0, 5.0, and 6.0Ah Makita batteries

Crimp Capacity		
Connector Type	Conductor Type	Range
Terminals & Splices	Copper	#8 AWG - 500 kcmil
Terminals & Splices	Flex Copper	#8 AWG - 350 kcmil
Terminals & Splices	Aluminum (AAC)	#8 AWG - 350 kcmil
Full-Tension	ACSR	#10 - 4/0 AWG
Taps	Copper	#10 - 2/0 AWG
Taps	AAC or ACSR	#14 - 4/0 AWG
Stirrups	ACSR	#6 - 4/0 AWG

GUY Blade Cutting Capacity	
Conductor Type	Maximum Size
Guy Wire (EHS)	3/8"

Interchangeable Jaw Assemblies:

- PATMD6LWJAW Crimp jaw with BG and D3 grooves
 PATMD68LWJAW Crimp jaw with O and D3 grooves
 PATMD66LWJAW Crimp jaw with D3 groove only
 PATMDCUTGLWJAW Cutting jaw with GUY blades

Accessories:

- PATMDCUTGUYKIT: GUY Replacement Blades (2 per kit)
 BAT18VLI: Hi-capacity LI Makita battery (3.0Ah)
 BAT18V5AHLI: Hi-capacity LI Makita battery (5.0Ah)
 PATCHGRLL: 120V-AC Makita charger
 PATCHGRLLDC: 12/24V-DC Makita charger
 W28K: Cutter Dies (cuts 4-4/0 CU, AL, ACSR)
 WDIETREE: W-die holder for 6 die sets
 CASEWDIES: W-die case holder for 12 die sets
 TOOLBAGMDLI: Tool bag (included with tool)



Models*: all listed include AC Charger

- PATMD16003A1: BG & D3, GUY Cutter, 3.0Ah batteries
 PATMD36003A1: O & D3, GUY Cutter, 3.0Ah batteries
 PATMD26003A1: D3 only, GUY Cutter, 3.0Ah batteries

 PATMD16005A1: BG & D3, GUY Cutter, 5.0Ah batteries
 PATMD36005A1: O & D3, GUY Cutter, 5.0Ah batteries
 PATMD26005A1: D3 only, GUY Cutter, 5.0Ah batteries

*Change A to D in catalog numbers for DC charger in place of AC charger.

Specifications:

- Output Force: 6 Tons
 Tool Weight: 5.50 lbs (without battery)
 Length:
 PATMD6LW 18.73"
 PATMD68LW 18.73"
 PATMD66LW 17.85"
 PATMD60003A1 19.25"
 Die Style: W and X (with crimping jaws)
 Operating Voltage: 18 V-DC Lithium-Ion
 Recharge Time:
 3.0Ah 30 minutes
 5.0Ah 45 minutes
 Warranty: 5 year limited warranty
 Lifetime warranty on INFINITY DRIVE®
 3 years on batteries and charger

See Important Notes page at start of Section.

PATRIOT® IN-LINE® Angle Pole Cutter/Crimper Hydraulic Self-Contained, 18V Lithium-Ion, 82"

Tool Series: PATMDCUT82ALLIF

- Adjustable Angular Head
- ASTM F711 Rated Pole for live line use
- Rocker trigger design for controlled actuation of the tool
- Safety lock to prevent accidental operation
- Includes 2 batteries and charger
- EP Enhanced Power — tools accept 2.0, 3.0, 4.0, 5.0, and 6.0Ah Makita batteries

For Use On: Maximum Cutting Capacity:

ACSR (26/7): 556.5 kcmil

Aluminum (AAC): 636 kcmil

Copper (soft drawn): 350 kcmil

Interchangeable Jaw Assemblies:

PATMD6LWJAW	Crimp jaw with BG and D3 grooves
PATMD68LWJAW	Crimp jaw with O and D3 grooves
PATMD66LWJAW	Crimp jaw with D3 groove only
PATMDCUTLWJAW	Cutting jaw with ACSR blades
PATMDCUTCLWJAW	Cutting jaw with CU/AL blades
PATMDCUTGLWJAW	Cutting jaw with GUY blades

Accessories:

BAT18VLI:	Hi-capacity LI battery (3.0 AH)
PATCHGRLI:	120V-AC Charger
PATCHGRLIDC:	12/24V-DC Charger
WDIETREE:	W-die holder for 6 die sets

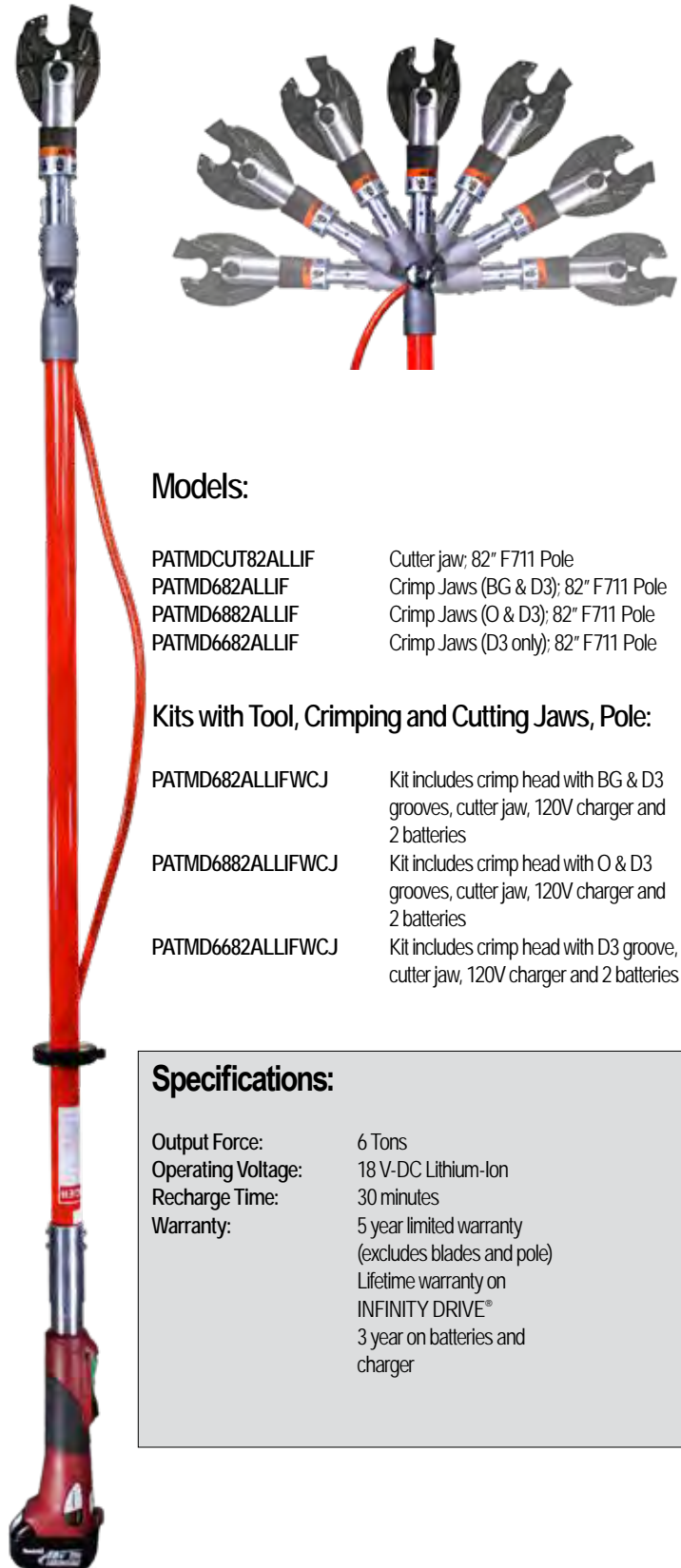

Models:

PATMDCUT82ALLIF	Cutter jaw; 82" F711 Pole
PATMD682ALLIF	Crimp Jaws (BG & D3); 82" F711 Pole
PATMD6882ALLIF	Crimp Jaws (O & D3); 82" F711 Pole
PATMD6682ALLIF	Crimp Jaws (D3 only); 82" F711 Pole

Kits with Tool, Crimping and Cutting Jaws, Pole:

PATMD682ALLIFWCJ	Kit includes crimp head with BG & D3 grooves, cutter jaw, 120V charger and 2 batteries
PATMD6882ALLIFWCJ	Kit includes crimp head with O & D3 grooves, cutter jaw, 120V charger and 2 batteries
PATMD6682ALLIFWCJ	Kit includes crimp head with D3 groove, cutter jaw, 120V charger and 2 batteries

Specifications:

Output Force:	6 Tons
Operating Voltage:	18 V-DC Lithium-Ion
Recharge Time:	30 minutes
Warranty:	5 year limited warranty (excludes blades and pole) Lifetime warranty on INFINITY DRIVE® 3 year on batteries and charger

See Important Notes page at start of Section.

**PATRIOT® Battery Actuated
Cable Cutter for Copper & Aluminum
Mechanically Driven, 18V Lithium-Ion**

Tool Series: PATCUT1500

- Variable speed trigger
- Forward/Reverse switch features a locking position
- Large, strategically placed, non-skid bumper
- LED Worklight
- Large, new cutting blade design
- Includes 1 battery, charger, and case
- **EP Enhanced Power** — tools accept 2.0, 3.0, 4.0, 5.0, and 6.0Ah Makita batteries

For Use On:

Aluminum: up to 1500 kcmil

Copper Flex: up to 1250 kcmil

Copper (soft drawn): up to 1000 kcmil

Copper (hard drawn): up to 750 kcmil

Do Not Cut Steel or ACSR



Models:

PATCUT1500LI with 3.0Ah Li-Ion battery, hard case
PATCUT1500L5 with 5.0Ah Li-Ion battery, hard case

PATCUT1500LIPB with 3.0Ah Li-Ion battery, pro bag
PATCUT1500L5PB with 5.0Ah Li-Ion battery, pro bag

Specifications:

Tool Weight: 6.90 lbs (without battery)
Size: 15.5" x 6.0" x 4.38"
Operating Voltage: 18 V-DC Lithium-Ion
Recharge Time:
 3.0Ah 30 minutes
 5.0Ah 45 minutes
Warranty: 3 year limited warranty (excluding blades)
 3 years on battery and charger

Accessories:

BAT18VLI: Hi-capacity LI Makita battery (3.0Ah)
BAT18V5AHLI: Hi-capacity LI Makita battery (5.0Ah)
PATCHGRLLI: 120V-AC Makita charger
PATCHGRLLDC: 12/24V-DC Makita charger
CASEPATCUT1500: Polymer carrying case
PT208620: Lanyard

See Important Notes page at start of Section.

Hand Operated, Latch Head Hydraulic Self-Contained Hand Operated

Tool: YCUT129ACSR

- Rapid advance pump
- Handle trigger drain
- Interference free closure on mid-span cuts
- 180° head rotation

For Use On:

Copper/Aluminum Cable:	up to 1.29"
ACSR:	up to 1113 kcmil
Ground Rod:	up to 5/8"
Rebar:	up to 1/2"
Soft Steel Bolts:	up to 5/8"
Standard Guy:	up to 1/2"
EHS Guy Strand:	up to 3/8"



Models:

YCUT129ACSR	Self-contained cutter
-------------	-----------------------

Specifications:

Output Force:	7 Tons
Weight:	11.4 lbs
Size:	22.50" x 6.63" x 2.50"
Warranty:	5 year limited warranty (excluding blades)

Accessories:

PT10024162:	Carrying Case (included with tool)
PT10037388:	Moving Blade
PT10037384:	Fixed Blade



PT10024162 Hard Polymer Case for YCUT129ACSR

Remote Operated, Scissor Action
Cuts up to 4.00" Copper/Aluminum Cable

Tool: RHCC4CUAL

- Specialized scissor head design for interference free closure for mid-span cuts
- High strength hardened steel cutting blades
- 360° swivel hose fitting
- Stainless Steel lifting assist eyebolt
- Light weight ergonomic design

For Use On:

Copper/Aluminum Cable: up to 4.00"



Models:

RHCC4CUAL

Standard remote cutter

Specifications:

Operating Pressure:	10,000 PSI
Weight:	19.9 lbs
Size:	21.29" x 9.13" x 5.15"
Warranty:	5 year limited warranty (excluding blades)



*BAGCNVS5X9X24 Canvas Bag available separately
(included with tool)*

Accessories:

BAGCNVS5X9X24:	Canvas Bag (included with tool)
RHCC4CUALBLD:	Cutting Blade (one blade; 2 required)
RHCC4CUALGDEBLD:	Blade Guide

*See Hydraulic Pumps and Hydraulic Hoses;
Pump Accessories
for other necessary equipment.*

Remote Operated, Latch Head Cuts up to 2156 kcmil ACSR

Tool Series: RHCC2156ACSR

- 180° head rotation
- Durable hardened, precision steel blades
- Specialized latch head for mid-span cuts
- Durable canvas carrying bag stores tool and accessories

For Use On:

Copper/Aluminum Cable:	up to 2"
ACSR:	up to 2156 kcmil
Ground Rod:	up to 3/4"
Rebar:	up to 5/8"
Soft Steel Bolts:	up to 3/4"
Standard Guy:	up to 9/16"
EHS Guy Strand:	up to 9/16"



Models:

RHCC2156ACSR	Standard RHCC2156ACSR remote cutter
RHCC2156ACSRF	RHCC2156ACSR tool with female coupler

Specifications:

Operating Pressure:	10,000 PSI
Weight:	10 lbs
Size:	13.17" x 4.13" x 2.69"
Warranty:	5 year limited warranty (excluding blades)

Accessories:

PT10054094:	Red Nylon Carry Bag (included with tool)
CUT200BLMVBL:	Replacement Moving Blade
CUT200BLSTA:	Replacement Fixed (Stationary) Blade

*See Hydraulic Pumps and Hydraulic Hoses;
Pump Accessories
for other necessary equipment.*



*PT10054094 Red Nylon Carry Bag available separately
(included with tool)*

Remote Operated, Latch Head
Cuts up to 1.29" Copper/Aluminum Cable

Tool: RHCC129ACSR

- Interference free closure for mid-span cuts
- Precision cutting blades for clean cuts
- High strength steel cylinder
- Light weight, ergonomic design
- Durable canvas carrying bag stores tool and accessories

For Use On:

Copper/Aluminum Cable:	up to 1.29"
ACSR:	up to 1113 kcmil
Ground Rod:	up to 5/8"
Rebar:	up to 1/2"
Soft Steel Bolts:	up to 5/8"
Standard Guy:	up to 1/2"
EHS Guy Strand:	up to 3/8"



Models:

RHCC129ACSR Standard remote cutter

Specifications:

Operating Pressure:	10,000 PSI
Weight:	6.2 lbs
Size:	11.41" x 3.65" x 2.33"
Warranty:	5 year limited warranty (excluding blades)

Accessories:

PT10043890:	Canvas Bag (included with tool)
PT10037388:	Moving Blade
PT10037384:	Fixed Blade

*See Hydraulic Pumps and Hydraulic Hoses;
Pump Accessories
for other necessary equipment.*



*PT10043890 Canvas Bag available separately
(included with tool)*

Remote Operated, Latch Head Cuts up to 2.45" Copper/Aluminum Cable

Tool: RHCC245CUAL

- Interference free closure for mid-span cuts
- Precision cutting blades for clean cuts
- Light weight ergonomic design
- Durable canvas carrying bag stores tool and accessories

For Use On:

Copper/Aluminum Cable: up to 2.45"



Models:

RHCC245CUAL Standard remote cutter



PT10054094 Red Nylon Carry Bag available separately
(included with tool)

Specifications:

Operating Pressure:	10,000 PSI
Weight:	8.4 lbs
Size:	14.80" x 4.74" x 2.45"
Warranty:	5 year limited warranty (excluding blades)

Accessories:

PT10054094:	Red Nylon Carry Bag (included with tool)
PT10038657:	Moving Blade
PT10040663:	Fixed Blade

*See Hydraulic Pumps and Hydraulic Hoses;
Pump Accessories
for other necessary equipment.*

Manual Cable Cutters For Copper/Aluminum Cable

Tool Series: MCC

- Rugged, high quality steel cutting blades
- Fiberglass handles with soft grips
- Excellent cutting edge performance
- Minimum of cable distortion

For Use On:

MCC600 Copper & Aluminum up to 600 kcmil
21" overall length
1.31" max. insulation diameter
3.5 lbs

MCC1000 Copper & Aluminum up to 1000 kcmil
32" overall length
1.90" max. insulation diameter
9.0 lbs



Models:

MCC600 Manual Cutter, up to 600 kcmil
MCC1000 Manual Cutter, up to 1000 kcmil

Specifications (MCC600):

Weight: 3.5 lbs
Size: 21.00 x 5.00" x 2.00"
Max. Insulation Dia.: 1.31"
Warranty: 1 year limited warranty (excluding blades)

Accessories:

MCC600BLADESET: Replacement blades for MCC600
MCC1000BLADESET: Replacement blades for MCC1000

Ratchet Cable Cutters For Copper/Aluminum Cable

Tool Series: RCC Cu/Al

- Rugged, high quality steel cutting blades
- Excellent cutting edge performance
- Minimal cable distortion

For Use On:

RCC600E: Copper & Aluminum 600 kcmil
10.50" overall length
1.05" max. insulation diameter
1.2 lbs

RCC750HD: Copper & Aluminum 750 kcmil
10.35" overall length
1.62" max. insulation diameter
2.6 lbs

RCC1000: Copper & Aluminum 1000 kcmil
20.00" overall length
2.38" max. insulation diameter
4.5 lbs

RCC600E



Models:

RCC600E	Ratchet Cutter, up to 600 kcmil
RCC750HD	Ratchet Cutter, up to 750 kcmil
RCC1000	Ratchet Cutter, up to 1000 kcmil

Specifications (RCC600E):

Weight:	1.2 lbs
Length:	10.50" x 3.50" x 1.25"
Max. Insulation Dia.:	1.05"
Warranty:	1 year limited warranty (excluding blades)

Accessories:

RPC701302:	Fixed Replacement Blade for RCC1000
RPC701402:	Moveable Replacement Blade for RCC1000

Ratchet Cable Cutters
For ACSR, Copper/Aluminum Cable

Tool Series: RCC Cu/Al/ACSR

- Quick release, bi-directional ratchet mechanism
- Rapid blade advance
- Easy cutting with minimal cable distortion

For Use On:

RCC336: Copper 350 kcmil;
Aluminum 500 kcmil;
ACSR 336 kcmil
10.5" overall length
1.25" max. insulation diameter
1.2 lbs

RCC556: Copper 500 kcmil;
Aluminum 500 kcmil;
ACSR 556.5 kcmil
21.00" overall length
1.40" max. insulation diameter
4.0 lbs

RCC954ACSR1K: Copper 1000 kcmil;
Aluminum 1000 kcmil;
ACSR 954 kcmil
22.75" overall length
1.38" max. insulation diameter
6.5 lbs



RCC954ACSR1K

Models:

RCC336	Ratchet Cutter, up to 336 ACSR
RCC556	Ratchet Cutter, up to 556 ACSR
RCC954ACSR1K	Ratchet Cutter, up to 954 ACSR

Specifications (RCC954ACSR1K):

Weight:	6.5 lbs
Size:	22.75" x 7.00" x 1.88"
Max. Insulation Dia.:	1.38"
Warranty:	1 year limited warranty (excluding blades)

Accessories:

RPC705501:	Fixed Replacement Blade for RCC556
RPC705601:	Moveable Replacement Blade for RCC556
RPC902101:	Fixed Replacement Blade for RCC336
RPC902201:	Moveable Replacement Blade for RCC336

Ratchet Wire Rope Cutters For Mild and Stainless Steel

Tool Series: RWRC

- Hardened steel blades
- Rapid blade advance
- Reduced handle force compared to scissor or compound action designs

For Use On:

RWRC516:

Mild Steel: 5/16" diameter
Stainless Steel: 1/4" diameter
10" overall length
5/16" diameter
1.2 lbs

RWRC916:

Mild Steel: 9/16" diameter
Stainless Steel: 1/2" diameter
20" overall length
9/16" diameter
4.4 lbs



RWRC916

Models:

RWRC516 Ratchet Cutter, up to 5/16" dia
RWRC916 Ratchet Cutter, up to 9/16" dia

Specifications (RWRC916):

Weight: 4.4 lbs
Size: 20.00" x 9.00" x 2.00"
Mild Steel Dia.: 9/16"
Stainless Steel Dia.: 1/2"
Warranty: 2 year limited warranty (excluding blades)

1/4" Dia. Wire Rope

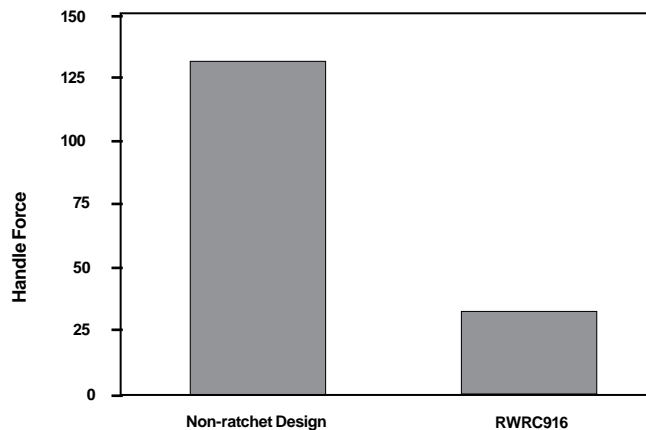

Electric Hydraulic Pump, 10,000 PSI
Light Weight, Space Saving Design

Pump Series: Y10AC9

- Easy to carry and transport
- Factory set relief valve
- 100,000+ life cycles
- Sealed electric pendant switch with 10-foot cord

For Use With:

10,000 PSI Remote Heads:

Y34BH, Y35BH, Y35BH4, Y750BHXT,
Y750CBHXT, Y45, Y46LWSBH, Y46LWBH,
Y60LW, Y4PC834MBH, Y444SBH,
Y81K2MBH, RHCC Series Cutters

*Examples of some of the remote
crimping and cutting heads for use
with Y10AC9 pump*



Models:

- | | |
|-----------|---|
| Y10AC9 | 10,000 psi electric hydraulic pump |
| Y10AC9OEM | 10,000 psi electric hydraulic pump with foot switch; pump features "Jog & Hold" |

Specifications:

Weight:	28.0 lbs (including oil)
Motor:	115V-AC 50/60 Hz 5/8 HP, 10,000 RPM
Height:	14.38"
Base:	8.25" x 6.50"
Max. Current Draw:	11 amp
Reservoir Volume:	1.61 quarts
Warranty:	5 year limited warranty

Accessories:

- | | |
|----------|---|
| YACCASE: | Steel carrying case with handle and locking latch |
| YACFC: | Foot control switch |

*See Hydraulic Hoses; Pump Accessories
for Hose options*

Electric Hydraulic Pump, 10,000 PSI Light Weight, Long Service Life

Pump: EPP10

- Lightweight, small size
- 100,000+ life cycles
- Durable remote pendant switch

For Use With:

10,000 PSI Remote Heads:

Y34BH, Y35BH, Y35BH4, Y750BHXT,
Y750CBHXT, Y45, Y46LWSBH, Y46LWBH,
Y60LW, Y4PC834MBH, Y444SBH,
Y81K2MBH, RHCC Series Cutters

*Examples of some of the remote crimping and cutting heads
for use with EPP10 pump*



Y750BHXT



RHCC245CUAL



Y81K2MBH



Models:

EPP10

10,000 psi electric hydraulic pump

Specifications:

Motor:	115V-AC/60 Hz 1/2 HP @ 3450 RPM
Max. Current Draw:	12.5 amperes
Weight:	30.0 lbs
Base:	18.00" x 8.00" x 6.00"
Height:	16.00"
Reservoir Volume:	2 quarts
Warranty:	5 year limited warranty

Accessories:

EPPCASE1:
PT9711:

Steel carrying case with handle, locking latch
Pendant switch

*See Hydraulic Hoses; Pump Accessories
for Hose options*

Electric Hydraulic Pump, 10,000 PSI
Dual Voltage/Hertz, Large Reservoir

Pump Series: EP10

- Dual voltage / hertz
- Oil level window
- 8 quart reservoir

For Use With:

10,000 PSI Remote Heads:

Y34BH, Y35BH, Y35BH4, Y750BHXT,
Y750CBHXT, Y45, Y46LWSBH, Y46LWBH,
Y60LW, Y4PC834MBH, Y444SBH,
Y81K2MBH, RHCC Series Cutters



Models:

EP10	10,000 psi electric hydraulic pump; 1/2 HP 115/230 V-AC; 60 cycle
EP102	10,000 psi electric hydraulic pump; 1/2 HP 220/230 V-AC; 50/60 cycle
EP101HP	10,000 psi electric hydraulic pump; 1 HP 115/230 V-AC; 60 cycle
EP101HP2	10,000 psi electric hydraulic pump; 1 HP 220/230 V-AC; 50/60 cycle



Y750BHXT



RHCC245CUAL



Y81K2MBH

Specifications:

Motor:	1/2 HP 115/230V-AC, 60 Cycle; 1/2 HP @ 3450 RPM
Max. Current Draw:	10 amperes
Reservoir Volume:	8 quarts max; 2 quarts min.
Height:	17.50"
Base:	11.75" x 18.50"
Dry Weight:	68.0 lbs (86.0 lbs with max. fluid)
Warranty:	5 year limited warranty

Accessories:

*See Hydraulic Hoses; Pump Accessories for
Hose options*

Electric Hydraulic Pump, 10,000 PSI Large 8 Quart Reservoir, Roll Cage

Pump: EPAC10

- Roll cage
- 3 position switch and control box
- Full automatic or manual "Jog and Hold" cycles
- Windows allow easy inspection of proper oil level

For Use With:

10,000 PSI Remote Heads:

Y34BH, Y35BH, Y35BH4, Y750BHXT,
Y750CBHXT, Y45, Y46LWSBH, Y46LWBH,
Y60LW, Y4PC834MBH, Y444SBH,
Y81K2MBH, RHCC Series Cutters

*Examples of some of the remote crimping and
cutting heads for use with EPAC10 pump*



Y60LW



RHCC129ACSR



Y81K2MBH



Models:

EPAC10 10,000 psi electric hydraulic pump

Specifications:

Motor:	1/2 HP 115/230V-AC, 60 Cycle; 1/2 HP @ 3450 RPM
Max. Current Draw:	10 amperes
Reservoir Volume:	8 quarts max; 2 quarts min.
Height:	17.50"
Base:	11.75" x 18.50"
Dry Weight:	68.0 lbs (82.0 lbs with max. fluid)
Warranty:	5 year limited warranty

Accessories:

*See Hydraulic Hoses; Pump Accessories for
Hose options*

Manual Hydraulic Pump, 10,000 PSI
Also Available in 6,000 PSI

Pump Series: HP10 and FP10

- Solid base with broad leg stabilizers
- Quick disconnect hydraulic fitting
- Built in handle for easy transport
- Factory set pressure release valve with audible click
- Quality, heavy duty foot pad with diamond plate steel (FP10)



HP10 Hand Pump

For Use With:

HP10

Used with: Y34BH, Y35BH, Y35BH4, Y750BHXT,
Y750CBHXT, Y45, Y46LWSBH, Y46LWBH,
Y60LW, Y4PC834MBH, Y444SBH, Y81K2MBH,
RHCC Series Cutters

FP10

Used with: Y34BH, Y35BH, Y35BH4, Y750BHXT, Y750CBHXT,
Y45, Y46LWSBH, Y46LWBH, Y60LW, Y4PC834MBH,
Y444SBH, Y81K2MBH, RHCC Series Cutters

FP6

Used with: Y29BH

Models:

HP10	10,000 psi hand pump
FP10	10,000 psi foot pump
FP6	6,000 psi foot pump

Specifications:

Weight:	18.0 lbs
Size:	24.75" x 6.75" x 3.00"
Height (open):	20.00"
Reservoir Volume:	1-1/8 quarts
Warranty:	5 year limited warranty

Accessories:

*See Hydraulic Hoses; Pump Accessories for
Hose options*

Gasoline Driven Hydraulic Pump, 10,000 PSI Heavy Duty 4 Horse Power Gasoline Engine

Pump: GP10

- Sturdy steel roll cage design
- Manual control valve
- Fast hose assembly; quick disconnect hydraulic coupler
- Large 8 quart reservoir

For Use With:

10,000 PSI Remote Heads:

Y34BH, Y35BH, Y35BH4, Y750BHXT,
Y750CBHXT, Y45, Y46LWSBH, Y46LWBH,
Y60LW, Y4PC834MBH, Y444SBH,
Y81K2MBH, RHCC Series Cutters

*Examples of some of the remote crimping
and cutting heads for use with GP10 pump*



Models:

GP10 10,000 psi gas driven hydraulic pump

Specifications:

Engine:	4 H.P.; 4 Cycle
Weight:	77.8 lbs (overall dry weight)
Size:	21.00" x 22.25" x 16.00"
Reservoir Volume:	8 quarts
Warranty:	5 year limited warranty

Accessories:

*See Hydraulic Hoses; Pump Accessories for
Hose options*



Y60LW



Y750BHXT

10,000 PSI Non Conductive Hoses

- 3 lengths available in 2 diameters
- Orange
- Stackable couplers (male/female)

Models:

PT2990010	10' length; 3/16" diameter
PT2990015	15' length; 3/16" diameter
PT2990025	25' length; 3/16" diameter
PT2990110	10' length; 1/4" diameter
PT2990115	15' length; 1/4" diameter
PT2990125	25' length; 1/4" diameter

Notes:

For proper care and maintenance of hydraulic hoses, consult the [Hydraulic Hose Care Manual](#); Form #7828.

1/4" diameter (available for 10,000 PSI only) hose provides a higher flow rate for faster ram movement.



6,000 PSI Non Conductive Hoses

- Orange
- Stackable couplers (male/female)

Models:

PT2990210	10' length; 3/16" diameter
-----------	----------------------------

10,000 PSI Conductive Hoses

- Stackable couplers (male/female)
- Steel braided with steel spring reinforced ends
- Black

Models:

PT91 8' length; steel braided with steel spring reinforced ends; stackable couplers (male/female); Black. No electrical rating.
DO NOT USE ON ENERGIZED CONDUCTOR



Notes:

For proper care and maintenance of hydraulic hoses, consult the **Hydraulic Hose Care Manual; Form #7828**.

8,800 PSI Conductive Hoses

- Stackable couplers (male/female)
- Steel braided with steel spring reinforced ends
- Black

Models:

PT76 8' length; steel braided with steel spring reinforced ends; stackable couplers (male/female); Black. No electrical rating.
DO NOT USE ON ENERGIZED CONDUCTOR



PT290741 Insulated Hose Carrying Bag

- Designed for protection and cleanliness for non conductive hoses; maximum carrying capacity of 10 lbs.
- Accommodates 100 feet of non-conductive hose coiled to 17-1/2" OD and 3-3/4" wide



ALFLUID™ Hydraulic Fluid for Pumps

- ALFLUIDQT is quart size; ALFLUIDGAL is gallon size
- All weather hydraulic fluid for BURNDY® pumps types HP hand pump, FP foot pump, GP gasoline pump, and EPP electric pump



PT93 (Female) and PT94 (Male)

- Replacement couplers for 10,000 PSI operating pressure (sold separately)



PT11018 In-Line Pressure Gauge for 10,000 PSI Hydraulic Pumps

- Pressure gauge for 10,000 PSI operating hydraulic pumps



PT29091 (Male) and PT292141 (Female)

- Replacement couplers for 6,000 PSI operating pressure (sold separately)



MD6CP1 Protective Jaw Covers

- Laminated vinyl jaw covers, supplied as set
- Compact, snap in place easily
- Fits all styles except Snub-Nose variations



PT4925 Canvas Bag

- Sturdy canvas bag for MD6/MD7 tool variations with or without covers in place
- Holds up to 9 die sets (sold separately)



PT6744 Jaw Cover (Snub-Nose)

- Semi-rigid Neoprene non-conductive material
- Fits all MD66 Snub-nose variations



PT49521 Steel Carrying Case

- Provides storage for the following: MD6, MD66, MD68, MD614, MD637, MD638, MD7, and MD76 with or without covers (sold separately)
- Holds up to 18 die sets (sold separately)



PT49311 Die Button Repair Kit

- Replacement die button kit for MD6/MD7 tool variations



PT6733 Hotstick Tool Carrying Bag

- Heavy-duty, adjustable canvas bag
- Accommodates 48", 60" and 72" variations of the MD6 and Y35 Hotstick tools



WBG Die Set

- Double groove die set
- One (1) crimp per end on service entrance sleeves
- Requires half the number of crimps on other 5/8" sleeves



W687 & W702 Non-Bowing Die Sets

- Install one-piece, full-tension UNISPLICE™ sleeves on ACSR conductors without bowing (sold separately)

W687: Installs #4 ACSR 6/1, 7/1; YDS4RL and YDS4RLY
#2 ACSR 6/1; YS2RL and YDS2RLY

W702: Installs #2 ACSR 7/1; YDS021RL and YDS021RLY
1/0 ACSR; YDS25RL and YDS25RLY



W28K Cutter Die Set

- Cuts #4 - 4/0 ACSR, Aluminum or Copper



WDIETREE W Die Holder

- Innovative die holder as alternative to the standard die case
- Designed to hold up to 6 W dies
- Shown with die sets (not included)



CASEWDIES Compact Die Case

- Space for 12 W or X style dies (not included)



PATPROBAG Heavy Duty Nylon Carry Bag

- Fits all PATRIOT® battery tools (excluding PATCUT4 series)
- Heavy Duty, Water-Resistant Nylon
- Corrosion Resistant Steel Hardware
- Dual Heavy Duty Zippers and Straps; Durable Base Liner and Reinforced Side Walls
- 19.4" x 11.5" x 11" and loaded with pockets for everything needed on the job



CASEUDIES15 Carry Case for U Dies

- Plastic case design for storage and protection of U dies
- Accommodates 15 die sets (standard or wide width U dies)
- Case is 11-1/4" x 7-1/2" x 3"
- Die sets sold separately
- CASEUDIES8 also offered, holds 8 die sets



PT6545 Die Case for S or P Style Die Sets

- Metal carrying case
- Accommodates 8 S or P Style Die Sets typically used with the Y45 and Y46 series of tools



HYFLUID™ Hydraulic Fluid for HYPRESS™ Tools

- HYFLUIDQT - quart size; HYFLUIDGAL - gallon size
- Hydraulic fluid for HYPRESS™ hand tools types Y35, Y352, Y750HSXT, and Y750CHSXT



PT294021

Adjustable Head Grip for Hot Stick PT294021 for Y35 and Y750 Remote Tools PT10128 for Y46 Tool

- Adjustable head grip for joining HYPRESS™ heads to universal hot sticks

Y35/Y39REPKITA Seal Repair Kit

- Seal repair kit for Y35 or Y39 (now discontinued) tools

Steel Carrying Cases for Y35 and Y352

- PT2972 - steel carrying case for Y35 tool
- PT29360 - steel carrying case for Y352 tool

Force Test Gauges For Battery Actuated and Self-Contained Hydraulic Tools Only

- Not recommended for remote powered heads*
- Easy to read dials
- Custom U die blanks with detent (12 & 15 ton tools)
- Custom ram puck and v-block gauge adapters (11 ton dieless tools)
- Comes complete with polymer carry case to protect blanks, adapters, and gauge; includes operating and maintenance manual.
- 1 year limited warranty

*see PT11018 in-line pressure gauge for 10,000 psi pumps

Models:

FORCEGAUGE1215 For 12 & 15 ton tools

Use with: Y750HSXT, PAT750 Series, and
PAT46 Series (with PUADP1 Adaptor)

Weight & Size: 2.7 lbs; 8.30" x 4.30" x 1.50"

PT292792 For 12 ton tools

Use with: Y35

Weight & Size: 2.7 lbs; 9.25" x 3.88" x 2.00"

FORCEGAUGE11 For 11 ton dieless tools

Use with: Y644HSXT, PAT644 Series, and PAT444S Series

Weight & Size: 2.7 lbs; 9.00" x 3.98" x 1.24"



FORCEGAUGE1215 with die blanks (included)



PT292792
with die blanks (included)



FORCEGAUGE11
(adapters not shown, included)

WIREMIKE™ Stainless Steel Wire Micrometer Available in multiple formats

- Strong, durable, high quality
- Most formats:
 - Allows for use as both caliper and ruler
 - Measures I.D. and O.D. of tubing
 - Measures thin-wall and rigid conduit including IPS
 - Measures ACSR, stranded and solid commercial cables

WIREMIKE, WIREMIKED and RK1942 are for use on:

- ACSR
 - #6 to 336.4 (26/7) Stranded
- Stranded AWG
 - #18 to 2000 kcmil
- Solid
 - #20 to 4/0 AWG
- IPS Tubing (Cu/Al) and Rigid Conduit:
 - 1/4" to 2-1/2"
- Tubing Sizes:
 - 3-1/8" inside maximum; 2-15/16" outside maximum
- Thin-wall Conduit:
 - 3/8" to 2-1/2"

WIREMIKECI is for use on:

- Compression Connectors and Splices (including Compression Grounding)
 - #18 to 2500 kcmil Copper Class B
 - #10 to 4/0 Solid Aluminum / Copper
 - #18 to 3500 kcmil Concentric Aluminum
 - #8 to 1100 kcmil Compact Aluminum
 - #14 to 1111 kcmil Copper DLO

Also used for reference only* for inspection of completed crimp when using Butting Copper or Aluminum Dies with the 750, 46, 35, or 39 series of tools.
Copper Dies U8CRT to U44XRT
Aluminum Dies U8CABT to U39ART-2



WIREMIKE

Models:

- WIREMIKE** Stainless Steel, inch/fraction markings
- WIREMIKECI** Stainless Steel, no ruler capabilities but may be used for reference on specific completed crimps (see more detail to left for WIREMIKECI)
- WIREMIKED** Stainless Steel, decimal markings in place of fraction markings, same capabilities as catalog # WIREMIKE™
- RK1942** Convenience packaging of WIREMIKE™ (with inch markings) in packaging suitable for hanging on a rack; sold in multiples of 10 only



Close up for the Die Inspection Section (Used for Reference Only*)
Catalog # WIREMIKECI only

*WIREMIKECI tool is to provide measurements for reference only, not to confirm the suitability of connection. Customer is responsible to independently verify suitability of connection.

Micro-Adjustable Professional Grade
Hand-Operated "Click-Type" Torque Wrenches

Tool Series: BTW

- Ratcheting, calibrated, dual direction
- Positive lock with spring-loaded pull-down lock ring
- Individually serialized with matching certificate of calibration traceable to N.I.S.T.
- ASME B107.14M-2004 and ISO 6789

For Use On:

Any mechanical connection with torque values within range of specific torque wrench. Including, but not limited to:

Types: SERVIT[®], OKLIP[™], VERSITAP[™], SCRULUG[™], Lay-In QIKLUG[™], VARITAP[™], VARILUG[™], KA-U Universal Terminals, UNITAP[™], POLYTAP[™], BARTAP[™], Type BIPC, Terminal Blocks, U-BLOK[™], SPEC-BLOK[™], VERSIPOLE[™]



Models:

BTW30150	Torque range 30 - 150 in-lbs; 10.25" long; 3/8" drive
BTW150750	Torque range 150 - 750 in-lbs; 16.00" long; 3/8" drive
BTW1575F12	Torque range 15 - 75 ft-lbs; 16.00" long; 1/2" drive



Specifications:

Accuracy:	±4% clockwise; ±6% counter clockwise of indicated value clockwise, from 20% to 100% of full scale
Applicable Standards:	ASME B107.14M-2004; ISO 6789
Calibration:	Traceable to N.I.S.T.
Warranty:	1 year limited warranty



WTB

- WEJTAP™ patented tool body
- One piece assembly
- Installs WEJTAP™ and STIRRUP™ connectors #8 AWG - 1590 kcmil ACSR with applicable tool head



WTBASY1

- WEJTAP™ ram replacement assembly

WEJTAP™ Boosters



- The WEJTAP™ System requires use of boosters for installation of connectors (red, blue, and yellow boosters match connectors)
- Boosters are available packaged with connectors and also sold separately

Red: [WPBRNBOX25](#)
Blue: [WPBBNBOX25](#)

Yellow: [WPBYNBOX25](#)



WTHY1S

- WEJTAP™ tool head
- Installs medium and large (yellow coded) connectors

WTOCBR and WTOCY



- WEJTAP™ removal clip for red/blue connectors (WTOCBR) with WTHRBY1S tool head
- WEJTAP™ removal clip for yellow connectors (WTOCY) with WTHY1S tool head



WTHRBY1S

- WEJTAP™ tool head
- Installs small and medium (red/blue coded) connectors



WTCK

- WEJTAP™ tool cleaning/maintenance kit for use with type WTB tool body
- Comes in clear carrying bag

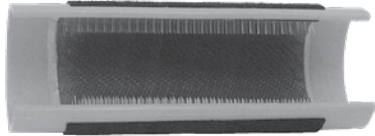

WHHWB

- Hand-held wire brush for cleaning surface contact areas on non-energized conductors



WTCC

- Plastic carrying case only; designed for rugged use in all weather conditions
- Accommodates WEJTAP™ installation tool, removal clips, and cleaning kit (sold separately)



WABAG

- Durable bag designed to carry installation tool(s), removal clips, cleaning kit, and hotstick accessories; Holders for power boosters located on outside of bag (all sold separately)

WEJTAP™ Kits with contents shown below

	*Non-Hotstick Power Unit	Hotstick Power Unit	Self-Firing Tool	Large Frame (Yellows)	Large Frame Take Off Clip	Small Frame (Red, Blue)	Cleaning Kit	Small Frame Take Off Clip	Molded Carrying Case	Canvas Style Tool Bag
Component Kit Catalog No.	WTBNHS*	WTB	WTBGBW	WTHY1S	WTOCY	WTHRB1S	WTCK	WTOCBR	WTCC	WABAG
WT2B2RBYWABAG		2		1	1	1	1	1		1
WTRBYK		1		1	1	1	1	1	1	
WTRBYKNHS	1			1	1	1	1	1	1	
WTYK		1		1	1		1			
WTYKNHS	1			1	1		1			
WTRBK		1				1	1	1	1	
WTRBKNHS	1					1	1	1	1	
WTY		1		1			1			
WTRB		1				1	1			
WTRBKNHSBAG	1					1	1	1		1
WTBGBWRBYK			1	1	1	1	1	1	1	
WTRBYWABAG		1		1	1	1	1	1		1
WTRBYKNHSBAG	1			1	1	1	1	1		1

*Note: Non-hotstick power units do not contain features allowing activation with hotsticks; they are not upgradeable.



WHSCWH

- Hotstick connector clamp holds tap connector and wedge for installation on energized lines with shotgun hotstick



WHSPBC

- Hotstick dual cable clamp to hold run and tap conductors in place during installation; for all applications #8-1272 ACSR



WHSWHADP

- Hotstick angle wedge holder adapter attaches wedge clamp to universal hotstick for hotline installation

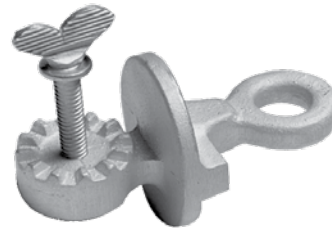

WCHAWAS

- Hotstick angle wedge holder adapter attaches wedge clamp to universal hotstick for installation using shotgun stick

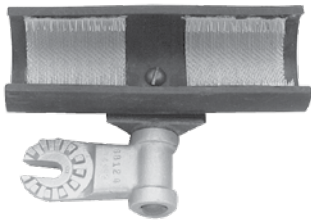

WHSWB

- Hotstick wirebrush attaches to universal hotstick for cleaning the contact surface of the line conductor



WHSGB

- Hotstick breech drive; geared shotgun hotstick adapter latches to breech end of tool without disassembly for use on energized lines



WHSTA

- Hotstick tool (actuator) hammer attaches to universal hotstick for striking the actuator button to complete installation

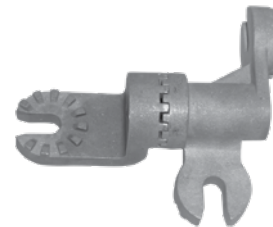

WHSSADP

- Hotstick spring loaded 90 degree adapter; used to attach tool to universal hotstick for hotline installations

DOMINATOR Auger Bits
For Treated Wood

Series: LPHTBIT

- Single Flute
- Hardened Steel Tip
- Aggressive lead screw
- Cuts hardest of woods with very fast drilling
- Self-feeding
- 100+ Holes



Close up of DOMINATOR
lead screw



Models & For Use On:

Treated Wood

		TREATED WOOD
OAL	DIA	DOMINATOR Models
18"	9/16"	LPHTBIT91618D
18"	5/8"	LPHTBIT5818D
18"	11/16"	LPHTBIT111618D
18"	3/4"	LPHTBIT3418D
18"	13/16"	LPHTBIT131618D
18"	15/16"	LPHTBIT151618D
24"	11/16"	LPHTBIT111624D
24"	13/16"	LPHTBIT131624D
24"	15/16"	LPHTBIT151624D



HIW716MAG
Hydraulic Impact Wrench



HIW716ENF
Hydraulic Impact Wrench

ENFORCER® Hydraulic Impact Wrench Variable Torque; 7/16" Quick Chuck

Tool Series: HIW-ENF

- Industry exclusive torque selector allows switching between 200 and 515 ft-lb torque settings
- Dual spool selector for Open and Closed systems
- Cartridge style valves for greater accuracy
- Internal safety relief valve



HIW716ENFTGKIT1 Hydraulic Impact Wrench shown with trigger guard, adapters and couplers

See our line of DOMINATOR Auger Bits

Models:

HIW716ENFKIT2	Wrench, eyelet, flat face couplers
HIW716ENFKIT3	Wrench, flat face couplers
HIW716ENFTGKIT1	Wrench, trigger guard, flat face couplers

Specifications:

Chuck Type:	7/16" Quick Change
Opt. Pressure:	750-2000 PSI
Flow Range:	4-12 GPM
Opt. Flow Range:	4-8 GPM
Weight:	5.95 lbs
Torque:	515 ft-lbs
Size:	9.00" x 7.75" x 3.12"
Warranty:	5 year limited warranty

Accessories:

HIW716ENFTGKIT:	Trigger guard assembly kit
LPHTADPMMOP66	SAE #6 to 3/8" NPT male-to-male adapter for Use with couplers listed below (2 required)
LPHTHTMANOSE66	3/8" male coupler (flat face) with 3/8" NPT (female thread) (1 per tool; 2 per hose)
LPHTHTMABODY66	3/8" female coupler (flat face) with 3/8" NPT (female thread) (1 per tool; 2 per hose)
LPHTHOSNCR66668	3/8" X 8' hose set
LPHTADPSMFOP66	SAE swivel adapter (2 required)

*(Recommended quantity for use with HIW716ENF)

See Low Pressure Hydraulic Accessories for additional options

MAG Series Hydraulic Impact Wrench
Machined Aluminum, Gerotor Design

Tool Series: HIW-MAG

- Aircraft grade extruded aluminum body, forged handle
- CNC machined parts
- Frictionless gerotor motor
- Cartridge style valve
- 7/16" Tri-ball quick change chuck
- Dual spool selector for Open & Closed systems
- "Glove-sized" wide grip activation trigger
- Inlet/Outlet SAE 6 adapters
- Reverse flow and hook-up protection
- Injection molded thermally insulated textured comfort grips
- Forward/Reverse selector

Accessories:

- LPHTADPMM71612 7/16" quick chuck to 1/2" square drive adapter
LPHTADPMMOP66 SAE #6 to 3/8" NPT male-to-male adapter for use with couplers listed below (2 required)
- LPHTHTMANOSE66 3/8" male coupler (flat face) with 3/8" NPT (female thread) (1 per tool; 2 per hose)
- LPHTHTMABODY66 3/8" female coupler (flat face) with 3/8" NPT (female thread) (1 per tool; 2 per hose)
- LPHTHOSNCR66668 3/8" X 8' hose set
LPHTHOSNCR666610 3/8" X 10' hose set
LPHTADPSMFOP66 SAE swivel adapter (2 required)

See Low Pressure Hydraulic Accessories for additional options



Models:

- HIW716MAGKIT1 Wrench, flat face couplers
HIW716MAGKIT2 Wrench, swivels, 8' NCR hose, flat face couplers
HIW716MAGKIT3 Wrench, swivels, 10' NCR hose, flat face couplers

Specifications:

Chuck Type:	7/16" Tri-ball quick chuck
Opt. Pressure:	1,000 - 2,000 PSI
Flow Range:	4 - 12 GPM
Opt. Flow Range:	4 - 8 GPM
Weight:	7.6 lbs
Torque:	550 ft-lbs
Size:	9.62" x 9.00" x 3.62"
Warranty:	5 year limited warranty

See our line of DOMINATOR Auger Bits



KOMPRESSOR™ Remote Operated 12 Ton Low Pressure Hydraulic Compression Tool

Tool Series: LPHY750

- Visual and audible crimp indicator
- 1.65" jaw opening covers a range of applications
- 350° head rotation
- Uses all standard BURNDY® U dies
- Crimp time approximately 2 seconds

For Use On:

Tension Sleeves

Copper	#8 sol. - 500 kcmil
Aluminum	#8 sol. - 587.2 kcmil
ACSR	#4 - 556.5 kcmil

Taps

Copper	#14 sol. - 500 kcmil
Aluminum	#8 - 500 kcmil

Aerial Cable

Copper	#6 - 500 kcmil
--------	----------------

Terminals & Splices

Copper	#8 - 750 kcmil
Aluminum	#8 - 750 kcmil
ACSR	#4 - 556.5 kcmil

HYGROUND® (Compression Grounding)

Copper	#8 - 500 kcmil
Ground Rods	1/2" - 1" diameter



LPHY750XT shown with couplers (sold separately)

Models:

LPHY750XT Standard KOMPRESSOR™ tool

Specifications:

Flow Rate:	3 - 9 GPM (11 - 34 LPM)
Operating Pressure:	1,500 - 2,500 PSI (103 - 172 BAR)
Force Developed:	12 Tons
Die Style:	U dies
Jaw Opening:	1.65"
Weight:	21.0 lbs (9.5 kg)
Size:	20.75" x 15.00" x 12.00"
Max. Back Pressure:	250 PSI (17 BAR)
Warranty:	5 year limited warranty

Accessories:

LPTHOSNCR66668OP:	Direct connect 8' non-conductive hose set
LPTHOSNCR666610OP:	Direct connect 10' non-conductive hose set
LPTHOSNCR66668:	*8' non-conductive hose set
LPTHOSNCR666610:	*10' non-conductive hose set
LPHTHTMANOSE66:	Male coupler 3/8" HTMA
LPHTHTMABODY66:	Female coupler 3/8" HTMA
LPHTADPSMFOP66:	SAE swivel adapter

*These hoses are used with LPHTADPSMFOP66 swivel adapter

See *Low Pressure Hydraulic Accessories*
for additional options

LPHT (Low Pressure Hydraulic Tool) Accessories

Catalog Number	Description
LPHTADPMM71612	7/16" Quick chuck adapter x 1/2" square
LPHTADPMMOP66	ADP Male/Male SAE #6, 3/8 NPT (2 required per tool)
LPHT HOSES Red or Orange	
LPHTHOSNCR666610	Hose; Insulated, 10 foot; 3/8 NPT, 3/8 NPT
LPHTHOSNCR66668	Hose; Insulated, 8 foot; 3/8 NPT, 3/8 NPT
LPHTHOSNCR66668OP	Hose; Insulated, 8 foot, SAE #6, 3/8 NPT
LPHTHOSNCR666610OP	Hose; Insulated, 10 foot, SAE #6, 3/8 NPT
COUPLERS	
LPHTDRIPBODY66	Dripless body; 3/8 body, 3/8 NPT
LPHTDRIPNOSE66	Dripless nose; 3/8 nose, 3/8 NPT
LPC12S	3/8, 1/2 NPT Flush face coupler set (body & nose)
LPHTHTMADUSTCAPF	HTMA dust cap body
LPHTHTMADUSTCAPM	HTMA dust cap nose

NOTE:

Only the most common accessories and sizes are shown. If you don't see what you are looking for call us at Customer Service: 1-800-346-4175.

Auger Bits are featured on the Auger Bit page earlier in the catalog.



This Page Intentionally Left Blank

Table of Contents

Introduction		
Basic Connection Principles.....	O-2	
Hardware Data		
DURIUM™ Steel/Aluminum Tightening Torques	O-6	
DURIUM™ Hex Bolts Data.....	O-6	
UL Tightening Torque UL 486.....	O-7	
Recommended Clamping on Bolted Connectors.....	O-9	
Cable Data (Tables)		
Copper Cable		
Copper Tube.....	O-10	
Solid Copper Wire.....	O-11	
Compact Stranded Copper Cable.....	O-11	
Stranded Copper Cable.....	O-12	
Flexible Copper Stranded Cable.....	O-14	
Aluminum and ACSR Cable		
Aluminum Tube	O-15	
Aluminum 1350 Cable Bare - Classes AA and A	O-16	
Aluminum 1350 Cable Bare - Class B	O-17	
ACSR Cable	O-18	
High Strength ACSR Cable	O-19	
Compact Aluminum 1350 Cable.....	O-19	
Aluminum Alloy 5005 Cable	O-20	
Aluminum 6201 Cable	O-20	
Aluminum Alloy 8000 Series "O" Temper Cable.....	O-21	
Compact ACSR Cable.....	O-23	
ACSR/TW Cable (Trap Wire).....	O-23	
AAC/TW Cable (All Aluminum Trap Wire)	O-24	
ACAR Cable	O-25	
SSAC Cable.....	O-25	
Steel Conductors		
Solid COPPERWELD® Cable.....	O-27	
Stranded COPPERWELD® - Copper Cable.....	O-27	
COPPERWELD® Copper Cable	O-28	
Galvanized Steel Cable	O-29	
Aluminum Coated Steel Cable.....	O-30	
Terminal Stud Size Chart	O-30	
AWG vs. Metric Wire Sizes.....	O-31	
Inches - Millimeters Conversion Chart.....	O-33	
BURNDY Conductor Numbering System	O-34	
Die Index Reference	O-36	
Present Installation Tool Index.....	O-37	
		Color Coding for Overhead Connectors
		O-48
		Color Coding for AL/CU Connectors.....
		O-48
		Color Coding for Copper Lugs and Splices
		O-49
		Product/Trade Name Index.....
		O-50
		Alpha-numeric Index.....
		O-51
		Notes pages (blank)
		O-122
		Standard Terms and Conditions of Sale.....
		O-128

Introduction - Basic Electrical Connection Principles

Basic Factors:

The basic factors which influence the design and performance of pressure wire connections are as follows:

1. Creep
2. Surface Oxide
3. Corrosion

A fourth factor, known as thermal effects, is also a consideration, but due to the technical nature and length of this topic, it will not be discussed here.

At the outset it should be pointed out that these factors give rise to much more difficult problems in connections involving aluminum conductors than those encountered in copper to copper connections.

Creep (Cold Flow)

Creep is the cold flow of the metal under pressure and it continues until the pressure reduces to a value at which any further creep is negligible. Creep properties depend on the particular metal or alloy and on its hardness; alloys having less creep than pure metals, and harder metals have less creep than soft metals.

In a typical connection, the conductors are generally of pure metal and often of soft temper and therefore, subject to considerable creep. In addition, the condition is further exaggerated when aluminum is the conductor as compared to copper, since its creep rate is many times that of copper.

Effect of Creep: Figure 2 shows typical curves of total contact resistance plotted against total contact force. Curve A shows how the contact resistance continually decreases with increasing contact force. When the full contact force F_1 is reached, the contact resistance reaches the low value of R_1 . In general, the full tightening force on a connector greatly exceeds the maximum force for which there is no appreciable creep. Therefore, the force will gradually settle down to a value after which there will be no further significant creep. Fortunately, however, the resistance does not climb back up along curve A, the tightening curve, but instead it follows a new curve B, the relaxing curve, along which the resistance changes very little until the force relaxes to a value such as F_2 .

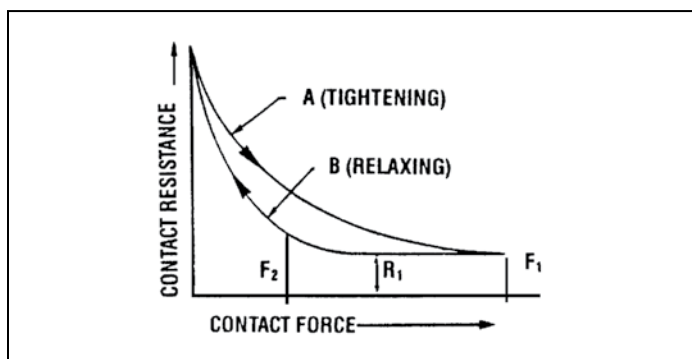

Figure 2

Admittedly, the point of “no appreciable creep” is difficult to define. For pure metals, especially in the soft state, there is always some creep, even at very low pressures at room temperature. However, we do know that the pressure required to produce the same creep rate is several times greater for copper than for aluminum. Thus, to permit the same contact force F_2 for aluminum and copper, the contact area A required for aluminum can be expected to be considerably greater than that required for copper. This explains why the contact areas for connectors for aluminum must be considerably greater than for copper and why many light duty connectors for copper are entirely inadequate for aluminum, even when specially plated and when recommended compounds are used on the contact surfaces.

Relaxation: Relaxation of pressure due to creep, or for any other reason, would be a much more difficult factor in a pressure connection were it not for the relationship of contact pressure to contact resistance on the relaxation curve as shown in Figure 2. It is frequently observed that some time after the bolts of a clamp type connector are tightened, the bolt tensions are relaxed appreciably. The question arises as to whether it is necessary to retighten the bolts to the original torque value. In a properly designed connector, retightening is unnecessary since the contact resistance should increase very little due to the relaxation of pressure, as shown by the relaxation curve of Figure 2.

This fact is largely responsible for the successful operation of a compression connector. The application of the compression tool applies very high pressure, establishing very low contact resistance. The removal of the compression tool releases a very large proportion of this pressure, and creep further relaxes this pressure. Fortunately, the contact resistance increases very little due to this pressure relaxation.

Contact Force: The previous analysis shows that the total contact force largely determines the contact resistance. Thus, to achieve the desired low value of contact resistance, the proper size and number of bolts in a clamp type connector must be supplied, and the compression tool must apply the proper force to a compression connector. In addition, the connector must be designed with sufficient structural strength, contact area, and resilience, to assure that the contact force cannot relax beyond the point where contact resistance begins to rise appreciably, as shown in Figure 2.

Surface Oxide

The contact of pure metallic surfaces cannot be assured in practical connections. Surface contamination must be expected, especially surface oxidation. These surface films are insulators as far as contact resistance is concerned, and they must be broken to achieve metal to metal contact to make an adequate electrical connection. The difficulty of breaking the film depends on the nature of the film, its thickness, and the metal on which it is formed.

Copper oxide is generally broken down by reasonably low values of contact pressure. Unless the copper is badly oxidized, good contact can be obtained with very little or no cleaning.

Introduction - Basic Electrical Connection Principles (continued)

Silver oxide is even more easily broken down by the contact pressure; and since silver oxide forms less readily at elevated temperatures, silver contact surfaces are preferred over copper when used for high temperatures. For this reason, it is considered good practice to silver plate copper contact surfaces that must operate at temperatures over 200° C.

On the other hand, aluminum oxide is a hard, tenacious, high resistance film that forms very rapidly on the surface of aluminum exposed to air. In fact, it is the toughness of this film that gives aluminum its good corrosion resistance. The oxide film that forms after more than a few hours is too thick and tough to permit a low resistance contact without cleaning. The aluminum oxide film is transparent so that even the bright and clean appearance of an aluminum connector is no assurance that the low contact resistance can be attained without cleaning.

In addition to the necessity for cleaning the oxide from aluminum, the surface should be covered with a good connector compound to prevent the oxide from reforming. Common practice is to clean the surface with a wire brush or emery cloth. The compound should be applied immediately after cleaning, or the compound should be put on first and the surface scraped through the compound. Present practice is to scratch brush dry and to apply the compound immediately thereafter. This allows a more thorough job of cleaning the conductor.

Contact Compounds: Petrolatum or No-Oxid are good contact surface compounds for aluminum, but BURNDY® PENETROX™ A, a petroleum type compound containing zinc dust, has the additional advantage of assisting in the breaking down of the contact resistance. How this is accomplished is not certain, but it appears that the zinc particles of PENETROX™ A probably act as current bridges in the breaks in the oxide film. For more complete information about the PENETROX™ line of compounds, refer to the Accessories section of this catalog.

Interstrand Resistance: The high contact resistance due to the oxide on the strands of an aluminum cable may be responsible for a poor distribution of current among the strands on the cable. Thus, the outer strands may carry much more than their share of the current and overheating of the cable may result. Tests have shown that even on new cable this effect of interstrand resistance can be considerable unless a good contact compound is used. The clamping action tends to break down the oxide and force the compound between the strands. This is particularly true of compression connectors due to the very high unit pressures developed.

The most effective way to break down interstrand resistance of aluminum cable is to use compression connectors filled with a compound having zinc particles. Then, when the end of the cable is inserted in the connector, the compound is forced between the strands where it very effectively breaks down the interstrand resistance upon application of the compressive force.

Plating Aluminum: Plating the contact surfaces of aluminum connectors will prevent the formation of aluminum oxide. Electro-tin, cadmium and zinc platings have been used for this purpose. However, the use of a plated aluminum connector does not make it less necessary to scratch brush the aluminum conductor, nor does it reduce the need for a good contact compound. Additional problems are introduced due to the plating on aluminum which render it of very doubtful value over the proper use of base aluminum. This will be more fully discussed later.

Corrosion

The electrical conductivity and mechanical strength of an electrical connection must remain stable under the deteriorating influences of the environment. This deterioration is corrosion. It is the electrolytic action of moisture and other elements of the atmosphere in conjunction with the metals of the connection. If the conductors and connectors are of copper or a corrosion resistant copper alloy, corrosion is usually a minor factor. However, it is a very vital factor if aluminum is involved.

If moisture can be kept away from the connection, corrosion will not be a factor. The electrical connection of a high voltage splice on insulated cable is generally free from corrosion since the taping may be used to avoid corrosion on bare cable, provided it excludes moisture. It is difficult to get a good tape seal to the conductor itself, especially on stranded cable. If moisture does penetrate the taping, it will not dry out as readily as if the joint were untaped. Various plastic materials are available today for covering low voltage connections or for bare conductor connections on high voltage. Unless such coverings are completely moisture-proof, it is better to rely on installation with a good contact compound, using a connector designed to resist corrosion.

Galvanic Action: Whenever dissimilar metals are in the presence of an electrolyte, a difference in electric potential is developed. One metal becomes the cathode and receives a positive charge. The other becomes the anode and receives a negative charge. When these metals are in contact, an electrical current will flow, as in the case of any short-circuited electric cell. This electrolytic action causes an attack of the anodic metal, leaving the cathodic metal unharmed. The extent of the attack is proportional to the strength of the electrolytic current, which in turn is proportional to the electric potential difference developed.

The magnitude of the potential difference generated between two dissimilar metals can be seen by the position of these metals in the electrolytic series. Figure 3 is such a series. When two metals are in contact in an electrolyte, the one higher up in this series is the anode, the corroded metal, while the one lower is the cathode, the protected metal. The further apart the metals are in this series, the greater the electrolytic potential difference, and the greater the attack to the anodic metal. Note that copper and aluminum are quite far apart in the series, copper being cathodic and aluminum anodic. Hence, when aluminum and copper are in contact in an electrolyte, the aluminum can be expected to be severely attacked.

Crevice Corrosion: Electrolytic attack can also occur between like metals due to a phenomenon known as oxygen concentration cell or crevice corrosion. Since oxygen is necessary for corrosive action, a variation in the concentration of oxygen where a metal is exposed to an electrolyte will generate a difference of potential, and cause a corrosive attack in the oxygen starved area. Thus, since an electrolyte in a deep crevice is freely exposed to the air at the outside, the concentration of oxygen will be greatest at the mouth of the crevice. Then corrosion can be expected to occur in the crevice remote from the surface. Crevice corrosion can be prevented if the crevice is filled with a compound to exclude moisture. Thus, within the contact groove of an aluminum connector containing an aluminum conductor, there will be numerous crevices in which corrosion will take place unless a good connector compound is applied during installation. Copper, being a more noble metal, appears to be much less subject to crevice corrosion.

Introduction - Basic Electrical Connection Principles (continued)

- ✦ LESS NOBLE (ANODIC)
- ↓ Magnesium
- ↓ Magnesium alloys
- ↓ Zinc
- ↓ Aluminum 1100
- ↓ Cadmium
- ↓ Aluminum 2024-T4
- ↓ Steel or Iron
- ↓ Cast Iron
- ↓ Chromium Iron (Active)
- ↓ Ni-Resist
- ↓ Type 304 Stainless (Active)
- ↓ Type 316 Stainless (Active)
- ↓ Lead Tin Solders
- ↓ Lead
- ↓ Tin
- ↓ Nickel (Active)
- ↓ Inconel
- ↓ Brasses
- ↓ Copper
- ↓ Bronzes
- ↓ Copper-Nickel alloys
- ↓ Monel
- ↓ Silver Solder
- ↓ Nickel (Passive)
- ↓ Inconel (Passive)
- ↓ Chromium-Iron (Passive)
- ↓ Type 304 Stainless (Passive)
- ↓ Type 316 Stainless (Passive)
- ↓ Silver
- ↓ Titanium
- ↓ Graphite
- ↓ Gold
- ↓ Platinum
- MORE NOBLE (CATHODIC)

Figure 3

Corrosion Testing: The effectiveness of an electrical connection to resist corrosion can be tested in the laboratory under conditions designed to greatly accelerate the natural corrosive conditions of actual service. The most widely accepted means is the standard salt spray chamber. In this chamber the specimens are placed in a salt fog made by atomizing a 20% salt solution at 100° F.

BURNDY, as well as other manufacturers and utility companies, have done a great deal of testing and a considerable area of agreement has been reached. There are, however, minor differences in recommended practices. The problem is concerned with aluminum and aluminum to copper connections since the effect of corrosion on copper to copper connections is far less serious. Let us study the recommended practices.

Aluminum to Aluminum Connections: For joining aluminum to aluminum conductors, there is little disagreement that an aluminum bodied connector is the proper choice, since this obviously eliminates the galvanic corrosion of dissimilar metals. However, even in this case, care must be taken to prevent crevice corrosion and to select an alloy of aluminum for the connector body that is free from cracking due to stress corrosion.

Aluminum to Copper Connections: Similarly, for joining aluminum to copper conductors, an aluminum bodied connector is the best choice since it prevents galvanic corrosion of the aluminum conductor, the most vulnerable element to attack in the connection. Realizing this, BURNDY initiated a research program aimed at finding the best way to make an aluminum connector suitable for joining aluminum to copper conductors.

This led to the evolution of the "Massive Anode Principle" of connector design for joining conductors of dissimilar metal. On the basis of this principle, properly designed, all-aluminum connectors became available for universal use in joining aluminum to aluminum or aluminum to copper conductors.

Massive Anode Principle: By making the aluminum connector massive in comparison to the copper conductor, when the copper conductor emerges from the connector, the electrolytic current density over the exposed face of the aluminum connector is greatly reduced. This is schematically represented in Figure 4. Since the rate of corrosion is directly related to the current density on the surface of the anodic material, the relatively large face of the aluminum connector will suffer only minor attack.

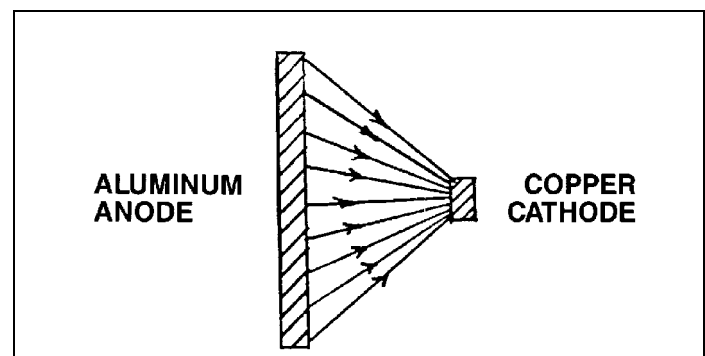

Figure 4

In addition, because the aluminum connector body is massive in the region where the corrosion occurs, the small loss of metal caused by corrosion is insignificant, even after long periods of service. Furthermore, the connector design should be such that clamping bolts, and areas of high stress which provide structural strength, are not in the regions subject to galvanic attack.

The effectiveness of this theory has been amply demonstrated in salt spray corrosion tests in which the connectors were subject to 1,000 hours in the salt

Introduction - Basic Electrical Connection Principles (continued)

spray fog with only minor corrosive pitting adjacent to the copper conductor, as seen in Figure 5. In addition, the aluminum conductor was completely protected, and the joint resistance remained virtually unchanged. The test involved a wide variety of sizes and types of connectors showing the effectiveness for small service connectors as well as large power connectors. Figure 6 shows a large all aluminum clamp type T connector installed on 3-1/2" diameter copper run and 750 kcmil aluminum tap. The figure shows this connector which was opened up after 1,400 hours of the salt spray test. Note that the contact surfaces are bright and clean and the only evidence is minor pitting along the faces adjacent to the copper.

*It should be emphasized that a good compound should be used on the contact surfaces whether aluminum or copper is used in an aluminum connector.

Position of Conductor: A properly designed aluminum connector for joining aluminum to copper must provide adequate separation between the conductors to prevent electrolytic attack on the aluminum conductor. Even then, it is good practice to install the aluminum conductor above the copper conductor if possible. This will prevent pitting of the aluminum conductor due to copper salts being washed over the aluminum.

Plated Aluminum Connectors: Plating has been used as a means to make an aluminum connector suitable for copper conductor. Such platings as copper, zinc, tin and cadmium have been used. The plating of aluminum is much more critical than plating a more noble metal such as copper. In addition, a preplate, usually of copper or brass, must be applied, thus introducing numerous metals and further possibilities for galvanic corrosion.

To be effective in reducing galvanic corrosion between the copper conductor and the aluminum connector, the plated metal must be closer in the Electrolytic Series to copper than is aluminum. It must therefore, be cathodic to aluminum. Since porosity and minor scratches are always present, galvanic action can be expected in the presence of moisture, resulting in attack of the aluminum under the plating. Corrosion tests reveal attack in the form of a mottled appearance and flaking of the plating.

In addition, the presence of plated metal can cause galvanic attack of the aluminum conductor, thus reducing the protection offered to this conductor in an aluminum connector.

Cleaning and the Use of Compound: It should be emphasized that when aluminum connectors or conductors are involved, proper cleaning of the aluminum and the use of a good connector compound, such as BURNDY PENETROX™ A, are essential for trouble-free service. BURNDY, as well as other manufacturers, provide the contact grooves with a coating to make it unnecessary to clean the connectors, but in all cases the aluminum conductor should be cleaned by means such as scratch brushing, and immediately coated with the connector compound.

To simplify the application of the compound, and to assure its use, almost all BURNDY aluminum connectors, except the large clamp type substation connectors, are supplied factory filled with PENETROX™ compound. For the tubular compression connectors, the tubular barrels are sufficiently filled with PENETROX™ and capped. For other types, the contact grooves are filled with PENETROX™ and enclosed in plastic packaging in a process called 'stripsealing'.

Clamp vs. Compression: In general, a compression connection can be expected to be more corrosion resistant than a clamp connection. The high pressures applied to a compression connector more effectively seal the contact against the penetration of moisture. The tubular sleeve of a compression connector has no side openings such as exist in clamp connectors between the clamping members. On the other hand, the clamp connector can be made more corrosion resistant if the conductor grooves conform more closely with the conductor contour. Thus a clamp connector made to accommodate a wide range of conductor sizes cannot be expected to be as corrosion resistant as one designed for one specific conductor size. Nevertheless, the differences in effectiveness of various designs can be minimized if a good contact compound is used.

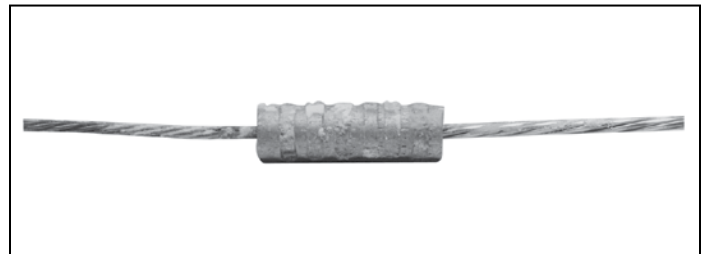

Figure 5

Negligible Corrosion of Severe Salt Spray on Compression Connector Joining Aluminum to Copper.

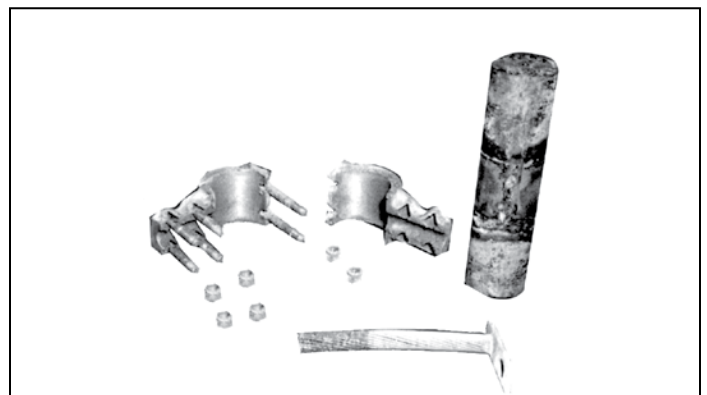

Figure 6

Large Aluminum Bolted Connector Joining Copper Run to Aluminum Tap After Severe Salt Spray Test.

HARDWARE DATA

Recommended Tightening Torque

The hardware used in connectors must be compatible with the connector material, have high mechanical strength and be corrosion resistant.

Copper alloy connectors have hardware made of DURIUM™, which is the BURNDY trade name for silicon bronze alloy ASTM B99. This material was first introduced by BURNDY in 1927 for use in outdoor construction and today is the standard throughout the industry.

Aluminum connectors generally have aluminum alloy hardware. The bolts are 2024T4 and anodized to resist corrosion. The nuts are 6061T6, which is resistant to corrosion and does not require anodizing. Bolts are lubricated to eliminate galling and to provide consistent clamping forces.

The size material for clamping hardware are selected to provide the required force when tightened to the recommended torque. To reduce or greatly exceed the recommended torque can adversely affect the performance of the connector.

Steel Hardware	
Bolt Size	Recommended Torque (Inch Pounds)
1/4 - 20	80
5/16 - 18	180
3/8 - 16	240
1/2 - 13	480
5/8 - 11	660
3/4 - 10	1050

Aluminum Hardware	
Bolt Size	Recommended Torque (Inch Pounds)
1/2 - 13	300
5/8 - 11	480
3/4 - 10	650

DURIUM™ (Silicon Bronze) Hexagonal Bolt Data

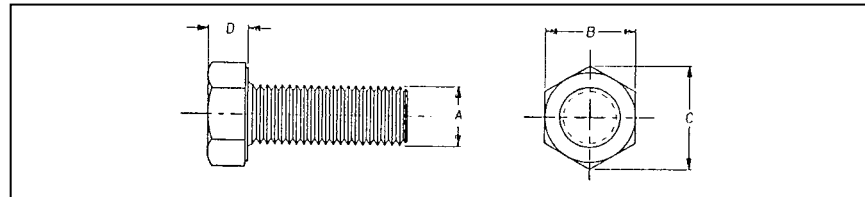

DURIUM™ (Silicon Bronze) Hardware							
Catalog Number Series*	"A" Bolt Size	"B"	"C"	"D"	Recommended Torque (in-lb)**	Min. Breaking Force (lb)	Min. Shearing Force (lb)
25X__HEB	1/4 - 20	7/16	.50	.16	80	1,780	990
31X__HEB	5/16 - 18	1/2	.56	.21	180	2,930	1,640
38X__HEB	3/8 - 16	9/16	.65	.24	240	4,350	2,430
50X__HEB	1/2 - 13	3/4	.87	.32	480	7,950	4,460
62X__HEB	5/8 - 11	15/16	1.08	.40	660	12,700	7,100
75X__HEB	3/4 - 10	1-1/8	1.30	.48	1050	17,510	10,540

* __ is substituted for bolt length; Consult sales representative for available lengths

**These torque values develop maximum bolt preload

This drawing is based on BURNDY engineering specification

HARDWARE DATA (continued)

Recommended Termination Hardware

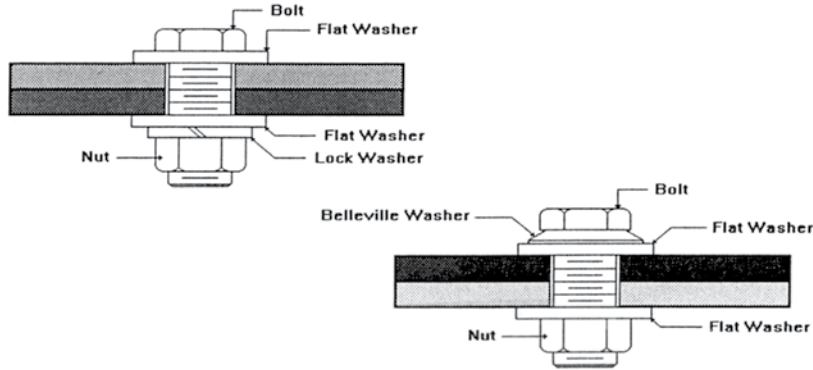

Recommended Tightening Torque per UL486A & UL486B

Table 21 - Tightening torque for screws

Test Conductor Size Installed in Connector		Tightening Torque, N•m (lbf-in)							
		Slotted Head No. 10 and Larger*				Hexagonal Head - External Drive Socket Wrench			
		Slot Width - 1.2mm (.047 in) or Less and Slot Length - 6.4mm (1/4 in.) or less		Slot Width - Over 1.2mm (.047 in) or Slot Length - Over 6.4mm (1/4 in.)		Split-Bolt Connectors		Other Connectors	
AWG or kcmil	mm ²	A	B	A	B	A	B	A	B
30 - 10	.05 - 5.3	1.7 (15)	2.3 (20)	2.8 (25)	4.0 (35)	7.3 (65)	9.0 (80)	6.8 (60)	8.5 (75)
8	8.4	2.3 (20)	2.8 (25)	3.4 (30)	4.5 (40)	7.3 (65)	9.0 (80)	6.8 (60)	8.5 (75)
6 - 4	13.2 - 21.2	2.8 (25)	4.0 (35)	4.0 (35)	5.1 (45)	15.3 (135)	18.6 (165)	10.2 (90)	12.4 (110)
3	26.7	2.8 (25)	4.0 (35)	4.5 (40)	5.6 (50)	25.4 (225)	31.1 (275)	14.1 (125)	16.9 (150)
2	33.6	3.4 (30)	4.5 (40)	4.5 (40)	5.6 (50)	25.4 (225)	31.1 (275)	14.1 (125)	16.9 (150)
1	42.4	-	-	4.5 (40)	5.6 (50)	25.4 (225)	31.1 (275)	14.1 (125)	16.9 (150)
1/0 - 2/0	53.5 - 67.4	-	-	4.5 (40)	5.6 (50)	35.6 (315)	43.5 (385)	16.9 (150)	20.3 (180)
3/0 - 4/0	85.0 - 107.2	-	-	4.5 (40)	5.6 (50)	45.2 (400)	56.5 (500)	22.6 (200)	28.2 (250)
250 - 350	127 - 177	-	-	4.5 (40)	5.6 (50)	62.1 (550)	73.4 (650)	28.2 (250)	36.7 (325)
400	203	-	-	4.5 (40)	5.6 (50)	76.3 (675)	93.2 (825)	28.2 (250)	36.7 (325)
500	253	-	-	4.5 (40)	5.6 (50)	76.3 (675)	93.2 (825)	33.9 (300)	42.4 (375)
600 - 750	304 - 380	-	-	4.5 (40)	5.6 (50)	90.4 (800)	113.0 (1000)	33.9 (300)	42.4 (375)
800 - 1000	406 - 508	-	-	4.5 (40)	5.6 (50)	111.7 (900)	124.3 (1100)	45.2 (400)	56.5 (500)
1250 - 2000	635 - 1000	-	-	-	-	111.7 (900)	124.3 (1100)	56.5 (500)	67.8 (600)

* For values of slot width or length not corresponding to those specified, select the largest torque value associated with the conductor size. Slot width is the nominal design value. Slot length shall be measured at the bottom of the slot.

HARDWARE DATA (continued)

Recommended Tightening Torque per UL486A & UL486B

Table 22 - Tightening torque for slotted head screws smaller than No. 10 intended for use with 8 AWG (8.4 mm²) or smaller conductors

Slot Length of Screw*		Tightening Torque, N•m (lbf-in)			
		Slot Width of Screw Smaller than 1.2 mm (.047 in.) ^b		Slot Width of Screw 1.2mm (.047 in.) and larger**	
mm	inch	A	B	A	B
Less than 4	Less than 5/32	0.68 (6)	0.79 (7)	0.79 (7)	1.0 (9)
4	5/32	0.68 (6)	0.79 (7)	1.1 (10)	1.4 (12)
4.8	3/16	0.68 (6)	0.79 (7)	1.1 (10)	1.4 (12)
5.6	7/32	0.68 (6)	0.79 (7)	1.1 (10)	1.4 (12)
6.4	1/4	0.79 (7)	1.0 (9)	1.1 (10)	1.4 (12)
7.1	9/32	-	-	1.4 (12)	1.7 (15)
Above 7.1	Above 9/32	-	-	1.8 (16)	2.3 (20)

* For slot lengths of intermediate values, select torques pertaining to next shorter slot length.

Also see Table 21 for screws with multiple tightening means.

Slot length shall be measured at the bottom of the slot.

** Slot width is the nominal design value

Recommended Tightening Torque per UL486A & UL486B

Table 23 - Tightening torque for screws with recessed allen or square drives

Socket Width Across Flats*		Tightening Torque, N•m (lbf-in)	
mm	inch	A	B
3.2	1/8	4.0 (35)	5.1 (45)
4.0	5/32	9.0 (80)	11.3 (100)
4.8	3/16	11.3 (100)	13.6 (120)
5.6	7/32	13.6 (120)	16.9 (150)
6.4	1/4	16.9 (150)	25.4 (225)
7.9	5/16	25.4 (225)	33.9 (300)
9.5	3/8	33.9 (300)	45.2 (400)
12.7	1/2	45.2 (400)	56.6 (500)
14.3	9/16	56.6 (500)	67.8 (600)

* See Table 21 for screws with multiple tightening means

HARDWARE DATA (continued)

Recommended Clamping on Bolted Connectors:

When installing a bolted connector, an appropriate sequence needs to be followed.

INSTALLATION INSTRUCTIONS:

1. Nuts need to be tightened up to 30% of expected torque.
2. A check needs to be done to ensure the clamping elements are even.

Even clamping elements

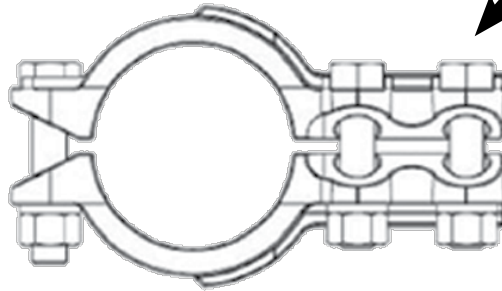

3. Tightening has to follow a sequence (1-6) as shown below. As a general rule, the torque has to be applied to the nut. For ease of installation most connectors are designed for one wrench installation. A torque wrench is recommended when tightening the nut to ensure the proper torque is applied.

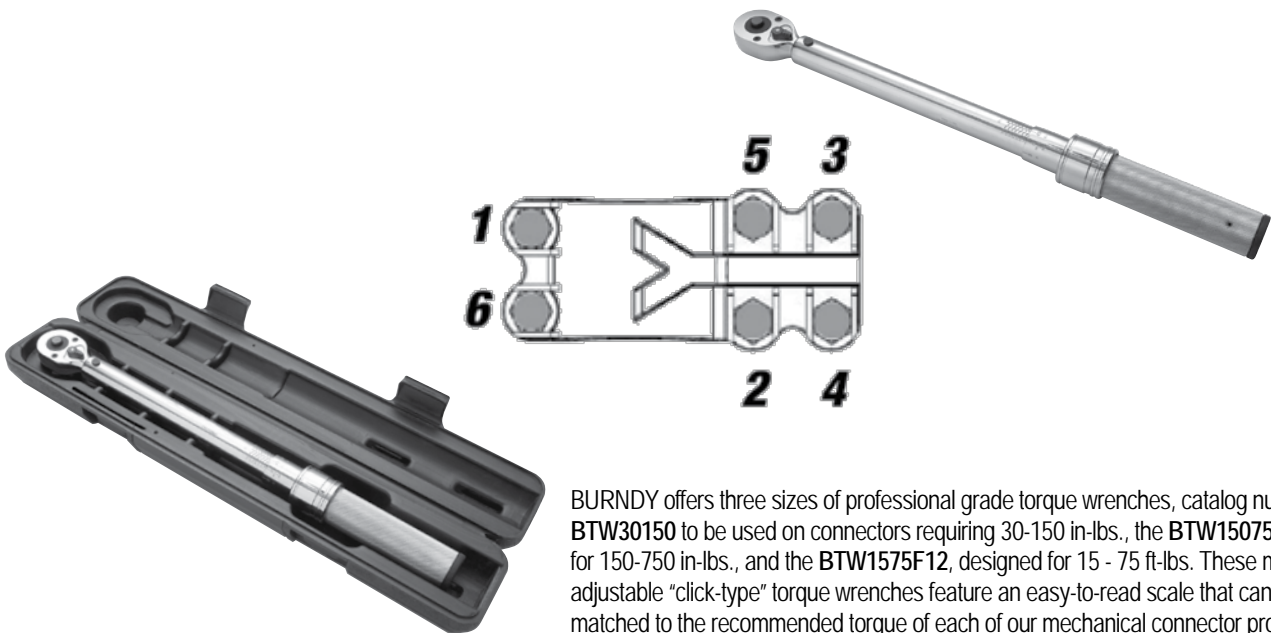

BURNDY offers three sizes of professional grade torque wrenches, catalog number **BTW30150** to be used on connectors requiring 30-150 in-lbs., the **BTW150750**, designed for 150-750 in-lbs., and the **BTW1575F12**, designed for 15 - 75 ft-lbs. These micro-adjustable "click-type" torque wrenches feature an easy-to-read scale that can be easily matched to the recommended torque of each of our mechanical connector products. Calibration traceable to N.I.S.T.

CABLE DATA

Copper Tube (Bus)

Size of Tube IPS	Diameter of Tube (Inches)		Wall Thickness (Inches)
	Outside	Inside	
STANDARD PIPE SIZES			
1/4"	0.540	0.375	0.082
3/8"	0.675	0.494	0.090
1/2"	0.840	0.625	0.107
3/4"	1.050	0.822	0.114
1"	1.315	1.062	0.126
1-1/4"	1.660	1.368	0.146
1-1/2"	1.900	1.600	0.150
2"	2.375	2.062	0.156
2-1/2"	2.875	2.500	0.187
3"	3.500	3.062	0.219
3-1/2"	4.000	3.500	0.250
4"	4.500	4.000	0.250
4-1/2"	5.000	4.500	0.250
5"	5.563	5.063	0.250
6"	6.625	6.125	0.250
EXTRA HEAVY PIPE SIZES			
1/4"	0.540	0.294	0.123
3/8"	0.675	0.421	0.127
1/2"	0.840	0.542	0.149
3/4"	1.050	0.736	0.157
1"	1.315	0.951	0.182
1-1/4"	1.660	1.272	0.194
1-1/2"	1.900	1.494	0.203
2"	2.375	1.933	0.221
2-1/2"	2.875	2.315	0.280
3"	3.500	2.892	0.304
3-1/2"	4.000	3.358	0.321
4"	4.500	3.818	0.341
4-1/2"	5.000	4.250	0.375
5"	5.563	4.813	0.375
6"	6.625	5.751	0.437

Size of Tube IPS	Diameter of Tube (Inches)		Wall Thickness (Inches)
	Outside	Inside	
DOUBLE EXTRA HEAVY PIPE SIZES			
1/2"	0.840	0.252	0.294
3/4"	1.050	0.434	0.308
1"	1.315	0.599	0.358
1-1/4"	1.660	0.896	0.382
1-1/2"	1.900	1.100	0.400
2"	2.375	1.503	0.436
2-1/2"	2.875	1.771	0.552
3"	3.500	2.300	0.600
3-1/2"	4.000	2.728	0.636
4"	4.500	3.152	0.674
4-1/2"	5.000	3.580	0.710
5"	5.563	4.063	0.750
6"	6.625	4.897	0.864

Tube dimensions (excepting wall thickness of double extra heavy) taken from A.S.T.M. Specification B42-33.

Tubular values based on a density of 0.322 pound per cubic inch.

* Conductivity of 98% I.A.C.S. at 20° C or 68° F

CABLE DATA (continued)

Solid Copper Wire (ASTM B1, B2, & B3)

Size AWG (Solid)	Wire Dia (Inch)	Hard Drawn	Medium Drawn	Soft Drawn
		Normal Breaking Load (Pounds)	Minimum Breaking Load (Pounds)	Elongation in 10 in. % Min.
18	.040	85.8	67.6	25
17	.045	107.5	84.7	25
16	.050	135.2	106.2	25
15	.057	170.0	133.0	25
14	.064	213.8	166.6	25
13	.071	268.2	208.0	25
12	.080	337.0	261.6	25
11	.090	422.5	327.6	25
10	.101	529.2	410.4	25
9	.114	661.0	514.2	30
8	.128	826.0	643.9	30
7	.144	1,030.0	806.6	30
6	.162	1,280.0	1,010.0	30
5	.181	1,591.0	1,265.0	30
4	.204	1,970.0	1,584.0	30
3	.229	2,439.0	1,984.0	30
2	.257	3,003.0	2,450.0	30
1	.289	3,688.0	3,024.0	30
1/0	.324	4,519.0	3,730.0	35
2/0	.364	5,518.0	4,599.0	35
3/0	.409	6,722.0	5,667.0	35
4/0	.460	8,143.0	6,980.0	35

Compact Stranded Copper Cable (ASTM B496)

Conductor Size		Number of Wires	Conductor Dia (in)
KCMIL	AWG		
1000		61 ¹	1.060
900		61 ¹	0.999
800		61 ¹	0.938
750		61 ¹	0.908
700		61 ¹	0.877
650		61 ¹	0.845
600		61 ¹	0.813
550		61 ¹	0.775
500		37 ²	0.736
450		37 ²	0.700
400		37 ²	0.659
350		37 ²	0.616
300		37 ²	0.570
250		37 ²	0.520
	4/0	19 ³	0.475
	3/0	19 ³	0.423
	2/0	19 ³	0.376
	1/0	19 ³	0.336
	1	19 ³	0.299
	2	7	0.268
	4	7	0.213
	6	7	0.169
	8	7	0.134

¹ 58 Wires Minimum² 35 Wires Minimum³ 18 Wires Minimum

CABLE DATA

Stranded Copper Wire (ASTM B8 Excluding Breaking Loads)

Size		A.S.T.M. Strandings			Hard Drawn	Medium Drawn	Soft Drawn
Stranded		Class	No. of Wires	Cable Diameter (Inches)	Minimum Breaking Load (Pounds)		
Circular Mils	AWG						
1,022	20	B	7	0.036	50.0	40.67	32.1
1,624	18	B	7	0.045	79.0	63.91	51.0
2,583	16	B	7	0.057	124.7	100.4	81.1
4,107	14	B	7	0.072	197.1	157.7	124.2
6,530	12	B	7	0.091	311.1	247.7	197.5
10,380	10	B	7	0.116	491.7	388.9	314.0
13,090	9	B	7	0.130	618.2	487.4	395.9
16,510	8	B	7	0.146	777.2	610.7	499.2
20,820	7	B	7	0.164	977.1	765.2	629.5
26,250	6	B	7	0.184	1,288.0	958.6	793.8
33,100	5	B	7	0.206	1,542.0	1,201.0	1,001.0
41,740	4	AA	3	0.254	1,879.0	1,465.0	1,213.0
41,740	4	B&A	7	0.232	1,938.0	1,505.0	1,262.0
52,630	3	AA	3	0.285	2,359.0	1,835.0	1,530.0
52,630	3	B&A	7	0.260	2,433.0	1,885.0	1,592.0
66,370	2	AA	3	0.320	2,913.0	2,299.0	1,929.0
66,370	2	B&A	7	0.292	3,045.0	2,361.0	2,007.0
83,690	1	AA	3	0.360	3,621.0	2,879.0	2,432.0
83,690	1	A	7	0.328	3,804.0	2,958.0	2,432.0
83,690	1	B	19	0.332	3,899.0	3,037.0	2,531.0
105,500	1/0	A&A	7	0.368	4,752.0	3,705.0	3,067.0
105,500	1/0	-	12	0.390	4,841.0	3,755.0	3,191.0
105,500	1/0	B	19	0.373	4,901.0	3,805.0	3,191.0
133,100	2/0	A&A	7	0.414	5,926.0	4,640.0	3,867.0
133,100	2/0	-	12	0.438	6,048.0	4,703.0	3,867.0
133,100	2/0	B	19	0.419	6,152.0	4,765.0	4,024.0
167,800	3/0	A&A	7	0.464	7,366.0	5,812.0	4,876.0
167,800	3/0	-	12	0.492	7,556.0	5,890.0	4,876.0
167,800	3/0	B	19	0.470	7,698.0	5,970.0	5,074.0
211,600	4/0	A&A	7	0.522	9,154.0	7,278.0	6,149.0
211,600	4/0	-	12	0.522	9,483.0	7,378.0	6,149.0
211,600	4/0	B	19	0.528	9,617.0	7,479.0	6,149.0

CABLE DATA

Stranded Copper Wire (ASTM B8 Excluding Breaking Loads) continued)

Size	A.S.T.M. Strandings			Hard Drawn	Medium Drawn	Soft Drawn
Circular Mills	Class	No. of Wires	Cable Diameter (Inches)	Minimum Breaking Load (Pounds)		
250 kcmil	AA	12	0.600	11,130	8,717	7,265
250 kcmil	A	19	0.574	11,360	8,986	7,265
250 kcmil	B	37	0.575	11,560	8,952	7,559
300 kcmil	AA	12	0.657	13,170	10,390	8,718
300 kcmil	A	19	0.628	13,510	10,530	8,718
300 kcmil	B	37	0.630	13,870	10,740	9,071
350 kcmil	AA	12	0.710	15,140	12,040	10,170
350 kcmil	A	19	0.679	15,590	12,200	10,170
350 kcmil	B	37	0.681	16,060	12,450	10,580
400 kcmil	A&AA	19	0.726	17,810	13,950	11,620
400 kcmil	B	37	0.728	18,320	14,140	11,620
450 kcmil	AA	19	0.770	19,750	15,590	13,080
450 kcmil	B&A	37	0.772	20,450	15,900	13,080
500 kcmil	AA	19	0.811	21,950	17,320	14,530
500 kcmil	B&A	37	0.813	22,510	17,550	14,530
600 kcmil	A&AA	37	0.891	27,020	21,060	17,440
600 kcmil	B	61	0.893	27,530	21,350	18,140
700 kcmil	AA	37	0.963	31,170	24,410	20,340
700 kcmil	B&A	61	0.964	31,820	24,740	20,340
750 kcmil	AA	37	0.997	33,400	26,150	21,790
750 kcmil	B&A	61	0.998	34,090	26,510	21,790
800 kcmil	AA	37	1.029	35,120	27,710	23,250
800 kcmil	B&A	61	1.031	36,360	28,270	23,250
900 kcmil	AA	37	1.092	39,510	31,170	26,150
900 kcmil	B&A	61	1.094	40,520	31,590	26,150
1000 kcmil	AA	37	1.151	43,830	34,400	29,060
1000 kcmil	B&A	61	1.152	45,030	35,100	29,060
1250 kcmil	A	61	1.288	55,670	43,590	36,320
1250 kcmil	B	91	1.289	56,280	43,880	36,320
1500 kcmil	A	61	1.411	65,840	51,950	43,590
1500 kcmil	B	91	1.412	67,540	52,650	43,590
1750 kcmil	A	91	1.526	77,930	61,020	50,850
1750 kcmil	B	127	1.526	78,800	61,430	50,850
2000 kcmil	A	91	1.630	87,790	69,270	58,120
2000 kcmil	B	127	1.632	90,050	70,210	58,120

CABLE DATA

Flexible Copper Stranded Cable

Conductor Size kcmil or B & S G (AWG)	# Strands	Strand Diameter	Nominal Diameter	Class
8	41	.0201	.156	I
8	49	.0184	.166	G
8	133	.0111	.167	H
8	168	.010	.157	K
8	420	.0063	.162	M
7	49	.0206	.185	G
7	52	.0201	.185	I
7	133	.0125	.188	H
7	210	.010	.179	K
7	532	.0063	.196	M
6	49	.0231	.208	G
6	63	.0201	.207	I
6	133	.0140	.210	H
6	266	.010	.210	K
6	665	.0063	.215	M
5	49	.0260	.234	G
5	84	.0201	.235	I
5	133	.0158	.237	H
5	336	.010	.235	K
5	836	.0063	.240	M
4	49	.0292	.263	G
4	105	.0201	.263	I
4	133	.0177	.266	.H
4	420	.010	.272	K
4	1064	.0063	.269	M
3	49	.0328	.295	G
3	133	.0199	.299	I
3	133	.0201	.291	H
3	532	.010	.304	K
3	1323	.0063	.305	M
2	49	.0368	.331	G
2	133	.0223	.335	I
2	161	.0201	.319	H
2	665	.010	.338	K
2	1666	.0063	.337	M
1	133	.0251	.377	G
1	210	.0201	.367	I
1	259	.018	.378	H
1	836	.010	.397	K
1	2107	.0063	.376	M
1/0	133	.0282	.423	I
1/0	259	.0202	.424	G
1/0	266	.0201	.441	H
1/0	1064	.010	.451	K
1/0	2646	.0063	.423	M

Conductor Size kcmil or B & S G (AWG)	# Strands	Strand Diameter	Nominal Diameter	Class
2/0	133	.0316	.474	G
2/0	259	.0227	.477	I
2/0	342	.0201	.500	H
2/0	1323	.010	.470	K
2/0	3325	.0063	.508	M
3/0	133	.0355	.533	G
3/0	259	.0255	.536	I
3/0	418	.0201	.549	H
3/0	1666	.010	.533	K
3/0	4256	.0063	.576	M
4/0	133	.0399	.599	G
4/0	259	.0286	.601	I
4/0	532	.0201	.613	H
4/0	2107	.010	.627	K
4/0	5320	.0063	.645	M
250	259	.0311	.650	G
250	427	.0242	.653	I
250	637	.0201	.682	.H
250	2499	.010	.682	K
250	6384	.0063	.713	M
300	259	.0340	.714	G
300	427	.0265	.716	I
300	735	.0201	.737	H
300	2989	.010	.768	K
300	7581	.0063	.768	M
350	259	.0368	.773	G
350	427	.0286	.772	I
350	882	.0201	.800	H
350	3458	.010	.809	K
350	8806	.0063	.825	M
400	259	.0393	.825	G
400	427	.0306	.826	I
400	980	.0201	.831	H
400	3990	.010	.878	K
400	10101	.0063	.901	M
450	259	.0417	.876	I
450	427	.0325	.878	G
450	1127	.0201	.894	H
450	4522	.010	.933	K
450	11396	.0063	.940	M
500	259	.0439	.922	G
500	427	.0342	.923	I
500	1225	.0201	.941	H
500	5054	.010	.988	K
500	12691	.0063	.997	M

CABLE DATA

Flexible Copper Stranded Cable (continued)

Conductor Size kcmil or B & S G (AWG)	# Strands	Strand Diameter	Nominal Diameter	Class
600	427	.0375	1.013	G
600	703	.0292	1.022	I
600	1470	.0201	1.027	H
600	5985	.010	1.125	K
600	14945	.0063	1.084	M
700	427	.0405	1.094	G
700	703	.0316	1.106	I
700	1729	.0201	1.194	H
700	6916	.010	1.207	K
700	17507	.0063	1.183	M
800	427	.0433	1.169	G
800	703	.0337	1.180	I
800	1995	.0201	1.290	H
800	7980	.010	1.305	K
800	20069	.0063	1.256	M
900	427	.0459	1.239	G
900	703	.0358	1.253	I
900	2261	.0201	1.372	H
900	9065	.010	1.323	K
900	22631	.0063	1.331	M
1000	427	.0484	1.307	G
1000	703	.0377	1.320	I
1000	2527	.0201	1.427	H
1000	10101	.010	1.419	K
1000	25193	.0063	1.404	M

Aluminum Tube

Size of Tube IPS	Diameter of Tube (Inches)		Wall Thickness (Inches)
	Outside	Inside	
STANDARD PIPE SIZES			
1/4"	0.540	0.364	0.088
3/8"	0.675	0.493	0.091
1/2"	0.840	0.622	0.109
3/4"	1.050	0.824	0.113
1"	1.315	1.049	0.133
1-1/4"	1.660	1.380	.0.140
1-1/2"	1.900	1.610	0.145
2"	2.375	2.067	0.154
2-1/2"	2.875	2.469	0.203
3"	3.500	3.068	0.213
3-1/2"	4.000	3.548	0.226
4"	4.500	4.026	0.237
4-1/2"	5.000	4.506	0.247
5"	5.563	5.047	0.258
6"	6.625	6.065	0.280
EXTRA HEAVY PIPE SIZES			
1/4"	0.540	0.302	0.119
3/8"	0.675	0.423	0.126
1/2"	0.840	0.546	0.147
3/4"	1.050	0.742	0.154
1"	1.315	0.957	0.179
1-1/4"	1.660	1.278	0.191
1-1/2"	1.900	1.500	0.200
2"	2.375	1.939	0.218
2-1/2"	2.875	2.323	0.276
3"	3.500	2.900	0.300
3-1/2"	4.000	3.364	0.318
4"	4.500	3.826	0.337
4-1/2"	5.000	4.290	0.355
5"	5.563	4.813	0.375
6"	6.625	5.761	0.432

CABLE DATA

Aluminum 1350 Cable Bare - Classes AA and A - Hard Drawn

Cable Code Word	Size (circular mils or AWG)	Copper Equivalent based on equal D.C. resistance, Cu 97% Al 61%	# of Wires	Cable Dia. (inches)	Ultimate Strength (pounds)
Peachbell	6	8	7	0.184	528
Rose	4	6	7	0.232	826
Lily	3	5	7	0.260	1022
Iris	2	4	7	0.292	1266
Pansy	1	3	7	0.328	1537
Poppy	1/0	2	7	0.368	1865
Aster	2/0	1	7	0.414	2350
Phlox	3/0	1/0	7	0.464	2845
Oxlip	4/0	2/0	7	0.522	3590
Daisy	266800	3/0	7	0.586	4525
Laurel	266800	3/0	19	0.593	4800
Tulip	336400	4/0	19	0.666	5940
Canna	397500	250000	19	0.724	6880
Cosmos	477000	300000	19	0.793	8090
Syringa	477000	300000	37	0.795	8600
Dahlia	556500	350000	19	0.856	9440
Mistletoe	556500	350000	37	0.858	9830
Orchid	636000	400000	37	0.918	11240
Violet	715500	450000	37	0.974	12640
Nasturtium	715500	450000	61	0.975	13150
Arbutus	795000	500000	37	1.026	13770
Lilac	795000	500000	61	1.028	14330
Anemone	874500	550000	37	1.077	14830
Crocus	874500	550000	61	1.078	15760
Magnolia	954000	600000	37	1.124	16180
Goldenrod	954000	600000	61	1.126	16860
Bluebell	1033500	650000	37	1.170	17530
Larkspur	1033500	650000	61	1.172	18260
Marigold	1113000	700000	61	1.216	19660
Narcissus	1272000	800000	61	1.300	22000
Carnation	1431000	900000	61	1.379	24300
Coreopsis	1590000	1000000	61	1.454	27000
Dogwood	1590000	1000000	91	1.454	28100

CABLE DATA

Aluminum 1350 Cable (Bare - Class B)

Size (circular mils or AWG)	Copper Equivalent based on equal D.C. resistance, Cu 97% Al 61%	# of Wires	Cable Dia. (inches)	Ultimate Strength (pounds) Hard Drawn	Minimum Ultimate Strength (pounds) 3/4 Hard	Minimum Ultimate Strength (pounds) Inter Temper
250000	157300	37	0.575	4860	3338	2946
300000	188800	37	0.629	5831	4005	3534
350000	220200	37	0.681	6680	4673	4123
400000	251500	37	0.728	7352	5341	4713
450000	283000	37	0.772	8110	6007	5301
500000	314500	37	0.813	9012	6675	5890
550000	346000	61	0.855	10490	7344	6480
600000	377000	61	0.893	11450	8010	7068
650000	409000	61	0.929	11940	8678	7657
700000	440000	61	0.964	12860	9346	8247
750000	472000	61	0.998	13510	10010	8835
800000	503000	61	1.031	14410	10680	9424
900000	566000	61	1.094	15900	12010	10600
1000000	629000	61	1.152	17670	13350	11780
1100000	692000	91	1.209	20210	14680	12950
1200000	755000	91	1.263	21630	16020	14130
1250000	786000	91	1.289	22530	16690	14720
1300000	818000	91	1.315	23430	17350	15310
1400000	880000	91	1.364	24750	18700	16500
1500000	943000	91	1.412	26500	20020	17670
1600000	1006000	127	1.459	28840	21360	18850
1700000	1069000	127	1.504	30630	22690	20020
1750000	1101000	127	1.526	31530	23350	20610
1800000	1132000	127	1.548	32450	24030	21210
1900000	1195000	127	1.590	33570	25360	22380
2000000	1258000	127	1.632	35340	26700	23560
2500000	1570000	127	1.824	43300	33380	29460
3000000	1890000	169	1.998	53010	40050	35340
3500000	2200000	169	2.158	60610	46730	41230

CABLE DATA

ACSR

Cable Code Word	Size (circular mils or AWG)	No. Alum Strands	No. Steel Strands	Complete Cable Dia. (inches)	Steel Core Dia. (inches)	Copper Equiv. based on equal D.C. resistance, Cu 97% Al 61%	Ultimate Strength (pounds)
Turkey	6	6	1	0.198	0.0661	8	1170
Thrush	5	6	1	0.223	0.0743	7	1460
Swan	4	6	1	0.250	0.0834	6	1830
Swanate	4	7	1	0.257	0.1029	6	2288
Swallow	3	6	1	0.281	0.0937	5	2250
Sparrow	2	6	1	0.316	0.1052	4	2790
Sparate	2	7	1	0.325	0.1299	4	3525
Robin	1	6	1	0.355	0.1182	3	3480
Raven	1/0	6	1	0.398	0.1327	2	4280
Quail	2/0	6	1	0.447	0.1490	1	5345
Pigeon	3/0	6	1	0.502	0.1672	1/0	6675
Penguin	4/0	6	1	0.563	0.1878	2/0	8420
Waxwing	266800	18	1	0.609	0.1217	3/0	7100
Owl	266800	26	7	0.633	0.2109	3/0	9645
Partridge	266800	26	7	0.642	0.2364	3/0	11250
Ostrich	300000	26	7	0.680	0.2505	188700	12650
Merlin	336400	18	1	0.684	0.1367	4/0	8950
Linnet	336400	26	7	0.721	0.2655	4/0	14050
Oriole	336400	30	7	0.741	0.3177	4/0	17040
Chickadee	397500	18	1	0.743	0.1486	250000	10400
Brant	397500	24	7	0.771	0.2575	250000	14690
Ibis	397500	26	7	0.783	0.2883	250000	16190
Lark	397500	30	7	0.806	0.3453	250000	19980
Pelican	477000	18	1	0.814	0.1628	300000	12300
Flicker	477000	24	7	0.846	0.2820	300000	17200
Hawk	477000	26	7	0.858	0.3162	300000	19430
Hen	477000	30	7	0.883	0.3783	300000	23300
Parakeet	556500	24	7	0.914	0.3045	350000	19850
Dove	556500	26	7	0.927	0.341	350000	22400
Eagle	556500	30	7	0.953	0.409	350000	27200
Peacock	605000	24	7	0.953	0.318	380500	21500
Squab	605000	26	7	0.966	0.356	380500	24100
Teal	605000	30	19	0.994	0.426	380500	30000
Rook	636000	24	7	0.977	0.326	400000	22600
Grosbeak	636000	26	7	0.990	0.365	400000	25000
Egret	636000	30	19	1.019	0.437	400000	31500
Flamingo	666600	24	7	1.000	0.333	419000	23700
Crow	715500	54	7	1.036	0.345	450000	26300
Starling	715500	26	7	1.051	0.387	450000	28100
Redwing	715500	30	19	1.081	0.463	450000	34600
Condor	795000	54	7	1.093	0.364	500000	28500
Drake	795000	26	7	1.108	0.408	500000	31200
Mallard	795000	30	19	1.140	0.489	500000	38400

CABLE DATA

ACSR (continued)

Cable Code Word	Size (circular mils or AWG)	No. Alum Strands	No. Steel Strands	Complete Cable Dia. (inches)	Steel Core Dia. (inches)	Copper Equiv. based on equal D.C. resistance, Cu 97% Al 61%	Ultimate Strength (pounds)
Crane	874500	54	7	1.146	0.382	550000	31400
Canary	900000	54	7	1.162	0.387	566000	32300
Cardinal	954000	54	7	1.196	0.399	600000	34200
Curlew	1033500	54	7	1.246	0.415	650000	37100
Finch	1113000	54	19	1.293	0.431	700000	40200
Pheasant	1272000	54	19	1.382	0.461	800000	44800
Plover	1431000	54	19	1.465	0.489	900000	50400
Falcon	1590000	54	19	1.545	0.515	100000	56000

High Strength ACSR

Cable Code Word	Size (circular mils or AWG)	No. Alum Strands	No. Steel Strands	Complete Cable Dia. (inches)	Steel Core Dia. (inches)	Copper Equivalent based on equal D.C. resistance, Cu 97% Al 61%	Ultimate Strength (pounds)
Grouse	80000	8	1	0.367	0.1670	50310	5200
Petrel	101800	12	7	0.461	0.2763	64160	9860
Minorca	110800	12	7	0.481	0.2883	69700	10730
Leghorn	134600	12	7	0.530	0.3177	84600	12920
Guinea	159000	12	7	0.576	0.3453	100000	15200
Dotterel	176900	12	7	0.607	0.3642	111200	16440
Dorking	190800	12	7	0.631	0.3783	120000	17730
Cochin	211300	12	7	0.663	0.3981	132900	19640
Brahma	203200	16	9	0.714	0.4885	127800	27500

Compact Aluminum 1350 Cable (ASTM B400) Extra Hard

Conductor Size		Class	No. of Wires	Cable Dia. (Inches)	Breaking Strength (pounds)
kcmil	AWG				
1000		B	61 ¹	1.060	17700
900		B	61 ¹	0.999	15900
800		B	61 ¹	0.938	14400
750		B	61 ¹	0.908	13500
700		B	61 ¹	0.877	12900
650		B	61 ¹	0.845	11900
600		B	61 ¹	0.813	11500
556		AA	19 ³	0.780	9750
550		B	61 ¹	0.775	10500
500		B	37 ²	0.736	9110
500		AA	19 ³	0.736	8760
477		AA	19 ³	0.722	8360
450		B	37 ²	0.700	8200
400		B	37 ²	0.659	7440
397		AA, A	19 ³	0.659	7110
350		B	37 ²	0.616	6760
350		A	19 ³	0.616	6390
336		A	19 ³	0.603	6150
336		AA	7	0.603	5960
300		B	37 ²	0.570	5890
300		A	19 ³	0.570	5480
300		AA	7	0.570	5430

Conductor Size		Class	No. of Wires	Cable Dia. (Inches)	Breaking Strength (pounds)
kcmil	AWG				
266		A	19 ³	0.537	4970
266		AA	7	0.537	4830
250		B	37 ²	0.520	4910
250		A	19 ³	0.520	4660
250		AA	7	0.520	4520
	4/0	B	19 ³	0.475	4020
	4/0	AA, A	7	0.475	3830
	3/0	B	19 ³	0.423	3310
	3/0	AA, A	7	0.423	3040
	2/0	B	19 ³	0.376	2670
	2/0	AA, A	7	0.376	2510
	1/0	B	19 ³	0.336	2160
	1/0	AA, A	7	0.336	1990
	1	B	19 ³	0.299	1740
	1	AA, A	7	0.299	1640
	2	AA, A, B	7	0.268	1350
	3	A, B	7	0.238	1090
	4	A, B	7	0.213	.881
	6	A, B	7	0.169	.563
	8	A, B	7	0.134	.312

CABLE DATA

Aluminum Alloy 5005 Cable (ASTM B397)

Conductor Size cmil	Number of Wires	Approx. Aluminum 1350 Size having Equivalent Resistance		Size & Stranding of ACSR with Equal Diameter			Rated Strength (pounds)
		cmil	AWG	cmil	AWG	Stranding	
927200	37	795000	-	795000	-	26/7	23900
740800	37	636000	-	636000	-	26/7	19300
652400	19	556500	-	556500	-	26/7	16200
587200	19	506500	-	506500	-	18/1	14600
559500	19	477000	-	477000	-	26/7	13900
503600	19	435500	-	435500	-	18/1	12500
465400	19	397500	-	397500	-	26/7	12200
419400	19	362000	-	362000	-	18/1	11200
394500	19	336400	-	336400	-	26/7	10500
355100	19	306400	-	306400	-	18/1	9600
312800	19	266800	-	266800	-	26/7	8450
281400	19	242900	-	242900	-	18/1	7610
246900	7	211600	4/0	211600	4/0	6/1	6330
195700	7	167800	3/0	167800	3/0	6/1	5020
155400	7	133100	2/0	133100	2/0	6/1	4280
123300	7	105600	1/0	105600	1/0	6/1	3440
77470	7	66360	2	66360	2	6/1	2200
48690	7	41740	4	41740	4	6/1	1430
30580	7	26240	6	26240	6	6/1	922

Aluminum Alloy 6201 Cable (ASTM B399)

Conductor Size cmil	Number of Wires	Approx. Aluminum 1350 Size having Equivalent Resistance		Size & Stranding of ACSR with Equal Diameter			Rated Strength (pounds)
		cmil	AWG	cmil	AWG	Stranding	
1439200	61	1272000	-	1272000	-	54/7	46800
1348800	61	1192500	-	1192500	-	54/7	43900
1259600	61	1113000	-	1113000	-	54/7	41000
1165100	61	1033500	-	1033500	-	54/7	37900
1077400	61	954000	-	954000	-	54/7	35000
927200	37	795000	-	795000	-	26/7	30500
740800	37	636000	-	636000	-	26/7	24400
652400	19	556500	-	556500	-	26/7	21900
559500	19	477000	-	477000	-	26/7	18800
465400	19	397500	-	397500	-	26/7	15600
394500	19	336400	-	336400	-	26/7	13300
312800	19	266800	-	266800	-	26/7	11000
246900	7	211600	4/0	211600	4/0	6/1	8560
195700	7	167800	3/0	167800	3/0	6/1	6790
155400	7	133100	2/0	133100	2/0	6/1	5390
123300	7	105600	1/0	105600	1/0	6/1	4460
77470	7	66360	2	66360	2	6/1	2800
48690	7	41740	4	41740	4	6/1	1760
30580	7	26240	6	26240	6	6/1	1110

CABLE DATA

Aluminum Alloy 8000 Series "O" Temper Cable (ASTM B801)

Conductor Size		Number of Wires†	Class	Conductor Diameter (inches)			Min. Breaking Strength (pounds)
kcmil	AWG			Conventional	Compressed	Compact	
1000		127	D	1.153	1.119	1.060	6010
1000		91	C	1.153	1.118	1.060	6010
1000		61	B, A	1.152	1.117	1.060	6010
900		127	D	1.095	1.062	0.999	5400
900		91	C	1.093	1.060	0.999	5400
900		61	B, A	1.093	1.060	0.999	5400
800		127	D	1.032	1.001	0.938	4800
800		91	C	1.032	1.001	0.938	4800
800		61	B, A	1.031	1.000	0.938	4800
750		127	D	0.998	0.968	0.908	4500
750		91	C	0.999	0.969	0.908	4500
750		61	B, A	0.998	0.938	0.908	4500
700		127	D	0.965	0.936	0.877	4200
700		91	C	0.965	0.936	0.877	4200
700		61	B, A	0.964	0.935	0.877	4200
650		127	D	0.930	0.902	0.845	3900
650		91	C	0.930	0.902	0.845	3900
650		61	B	0.929	0.901	0.845	3900
650		37	A	0.928	0.900	0.845	3950
600		127	D	0.893	0.866	0.813	3600
600		91	C	0.893	0.866	0.813	3600
600		61	B	0.893	0.866	0.813	3600
600		37	A	0.891	0.864	0.813	3640
556		127	D	0.861	0.835	0.780	3340
556		91	C	0.860	0.834	0.780	3340
556		61	B	0.860	0.834	0.780	3340
556		37	A	0.858	0.832	0.780	3380
550		127	D	0.855	0.829	0.775	3300
550		91	C	0.855	0.829	0.775	3300
550		61	B	0.855	0.829	0.775	3300
550		37	A	0.853	0.827	0.775	3340
500		91	D	0.815	0.791	0.736	3000
500		61	C	0.815	0.791	0.736	3000
500		37	B, A	0.813	0.789	0.736	3040
477		91	D	0.796	0.772	0.722	2860
477		61	C	0.796	0.772	0.722	2860
477		37	B, A	0.795	0.771	0.722	2900
450		91	D	0.773	0.750	0.700	2700
450		61	C	0.773	0.750	0.700	2700
450		37	B, A	0.772	0.749	0.700	2730
400		91	D	0.729	0.707	0.659	2400
400		61	C	0.729	0.707	0.659	2400
400		37	B, A	0.728	0.706	0.659	2430
397		91	D	0.727	0.705	0.659	2390
397		61	C	0.726	0.704	0.659	2390
397		37	B	0.725	0.703	0.659	2410
397		19	A	0.724	0.702	0.659	2470

CABLE DATA

Aluminum Alloy 8000 Series "O" Temper Cable (ASTM B801) (Continued)

Conductor Size		Number of Wires†	Class	Conductor Diameter (inches)			Min. Breaking Strength (pounds)
kcmil	AWG			Conventional	Compressed	Compact	
350		91	D	0.682	0.661	0.616	2100
350		61	C	0.681	0.661	0.616	2100
350		37	B	0.681	0.661	0.616	2130
350		19	A	0.679	0.659	0.616	2170
336		61	C	0.669	.0649	0.603	2020
336		37	B	0.668	0.648	0.603	2040
336		19	A	0.666	0.646	0.603	2090
300		61	C	0.631	0.612	0.570	1800
300		37	B	0.630	0.611	0.570	1820
300		19	A	0.629	0.610	0.576	1860
266		61	C	0.595	0.577	0.537	1600
266		37	B	0.594	0.576	0.537	1620
266		19	A	0.593	0.575	0.537	1660
250		61	C	0.576	0.559	0.520	1500
250		37	B	0.575	0.558	0.520	1520
250		19	A	0.574	0.557	0.520	1550
	4/0	37	C	0.529	0.513	0.475	1280
	4/0	19	B	0.528	0.512	0.475	1310
	4/0	7	A	0.522	0.506	0.475	1360
	3/0	37	C	0.471	0.457	0.423	1020
	3/0	19	B	0.470	0.456	0.423	1040
	3/0	7	A	0.464	0.450	0.423	1070
	2/0	19	B	0.419	0.406	0.376	826
	2/0	7	A	0.414	0.402	0.376	853
	1/0	19	B	0.373	0.362	0.336	655
	1/0	7	A	0.368	0.357	0.336	676
	1	19	B	0.332	0.322	0.229	519
	2	7	B, A	0.292	0.283	0.268	425
	3	7	B, A	0.260	0.252	0.238	337
	4	7	B, A	0.232	0.225	0.213	267
	6	7	B, A	0.184	0.178	0.169	168
	8	7	B, A	0.146	0.142	0.134	106

† For compact-stranded constructions, the number of wires may be reduced as follows:

19-Wire Constructions - 18 Wires Minimum

61-Wire Constructions - 58 Wires Minimum

127-Wire Constructions - 122 Wires Minimum

37-Wire Constructions - 35 Wires Minimum

91-Wire Constructions - 87 Wires Minimum

CABLE DATA

Compact ACSR (ASTM B401)

Conductor Size		Cable Diameter (Inches)	Breaking Strength (pounds)
kcmil	AWG		
336.4		0.628	8260
266.8		0.559	6540
	4/0	0.517	7420
	3/0	0.461	5880
	2/0	0.410	4880
	1/0	0.365	3980
	1	0.326	3290
	2	0.298	3260
	2	0.290	2640
	3	0.258	2130
	4	0.236	2160
	4	0.229	1760
	6	0.182	1120

ACSR/TW (Trap Wire) Cable (ASTM B779)

Conductor Size kcmil	Stranding		Nominal Diameter (inches)	Rated Strength (pounds)
	No. Aluminum Wires	No. Steel Wires		
336.4	14	1	0.63	8600
405.1	14	1	0.68	10200
477.0	18	7	0.78	17200
477.0	18	7	0.79	19400
556.5	18	7	0.84	20000
556.5	20	7	0.85	22600
565.3	20	7	0.86	22900
571.7	18	7	0.85	20600
636.0	27	1	0.85	13500
636.0	18	7	0.89	22900
636.0	20	7	0.91	25400
664.8	20	7	0.93	26600
666.6	20	7	0.91	24000
762.8	20	7	0.99	30500
768.2	20	7	0.98	27700
768.9	27	1	0.93	16400
795.0	17	7	0.96	21000
795.0	18	7	0.98	25900
795.0	20	7	0.99	28200
795.0	20	7	1.01	31800
946.7	35	7	1.08	29600
954.0	30	7	1.05	23700
954.0	32	7	1.06	25900
954.0	20	7	1.08	33500
957.2	32	7	1.06	26000
959.6	22	7	1.11	37000
966.2	21	7	1.09	34000

Conductor Size kcmil	Stranding		Nominal Diameter (inches)	Rated Strength (pounds)
	No. Aluminum Wires	No. Steel Wires		
1033.5	30	7	1.09	25700
1033.5	32	7	1.10	28100
1033.5	21	7	1.13	36300
1113.0	30	7	1.13	27500
1113.0	33	7	1.14	30000
1113.0	38	19	1.19	39100
1158.0	33	7	1.17	31600
1158.4	25	7	1.20	39600
1168.1	30	7	1.16	28900
1192.5	30	7	1.17	29500
1192.5	33	7	1.18	32400
1192.5	38	19	1.22	41900
1233.6	38	19	1.25	42900
1257.1	35	7	1.21	34200
1272.0	30	7	1.20	31400
1272.0	35	7	1.22	34600
1272.0	39	19	1.26	44100
1334.6	39	19	1.29	46300
1351.5	35	7	1.26	36700
1351.4	39	19	1.30	46800
1359.7	36	7	1.26	36900
1372.5	30	7	1.25	33400
1431.0	36	7	1.29	38900
1431.0	39	19	1.34	49600
1433.6	39	19	1.34	49700
1455.3	36	7	1.30	39200
1467.8	33	7	1.29	35800

CABLE DATA

ACSR/TW (Trap Wire) Cable (ASTMB779)

Conductor Size kcmil	Stranding		Nominal Diameter (Inches)	Rated Strength (pounds)
	No. Aluminum Wires	No. Steel Wires		
1533.3	39	19	1.38	53200
1557.4	36	7	1.35	41900
1569.0	33	7	1.33	38200
1590.0	36	7	1.36	42200
1590.0	42	19	1.41	55100
1622.0	39	19	1.42	57500
1657.4	36	7	1.39	44000
1730.6	39	19	1.47	59400
1758.6	37	19	1.47	34600
1780.0	37	19	1.45	50700
1926.9	42	19	1.55	65300
1949.6	42	7	1.50	51900
2153.8	64	19	1.60	61100
2156.0	64	19	1.61	61100
2627.3	64	19	1.76	74500

AAC/TW (ALL ALUMINUM TRAP WIRE) (ASTM B778)

Conductor Size kcmil	Nominal Diameter (inches)	Number of Wires	Rated Strength (pounds)
336.4	0.612	17	6220
397.5	0.661	17	7230
477.0	0.720	17	8530
500.0	0.736	17	8940
556.5	0.775	17	9950
600.0	0.803	17	10700
636.0	0.825	17	11400
700.0	0.864	17	12500
750.0	0.893	17	13400
795.0	0.919	17	13900
900.0	0.990	31	15800
954.0	1.018	31	16700
1000.0	1.041	31	17500
1033.5	1.057	31	18100
1113.0	1.095	31	19500
1192.5	1.132	31	20900
1272.0	1.168	31	22300
1351.5	1.202	31	23700
1431.0	1.236	31	24600
1590.0	1.315	49	27300
1750.0	1.377	49	30000
2000.0	1.468	49	34300

CABLE DATA

ACAR Cable (ASTM B524)

Conductor Size		Number of Wires	Nominal Outside Diameter (inches)
kcmil	AWG		
2000		91	1.630
2000		61	1.630
1900		61	1.588
1800		61	1.546
1750		61	1.525
1700		61	1.502
1600		61	1.458
1500		61	1.411
1400		61	1.364
1300		61	1.314
1300		37	1.312
1250		61	1.288
1250		37	1.287
1200		61	1.263
1200		37	1.261
1100		61	1.209
1100		37	1.207
1000		61	1.152
1000		37	1.151
950		37	1.121
900		37	1.092
850		37	1.061
800		37	1.029
750		37	0.997
700		37	0.962

Conductor Size		Number of Wires	Nominal Outside Diameter (inches)
kcmil	AWG		
650		37	0.928
600		37	0.891
600		19	0.888
550		37	0.853
550		19	0.850
500		37	0.813
500		19	0.811
450		19	0.770
400		19	0.726
350		19	0.678
300		19	0.628
250		19	0.574
246.9		7	0.563
	4/0	7	0.522
195.7		7	0.502
	3/0	7	0.464
155.4		7	0.447
	2/0	7	0.414
123.3		7	0.398
	1/0	7	0.368
77.4		7	0.316
	2	7	0.292
48.6		7	0.250
	4	7	0.232
30.5		7	0.198

SSAC CABLE

Size AWG or kcmil	# Alum Strands	# Steel Strands	Conductor Diameter	Rated Strength (pounds)
266.8	22	7	.622	6030
266.8	24	7	.633	7410
266.8	26	7	.642	8880
266.8	30	7	.660	11700
300.0	26	7	.680	9970
336.4	20	7	.692	5990
336.4	22	7	.701	7610
336.4	24	7	.710	9340
336.4	26	7	.720	11200
336.4	30	7	.741	14800
397.5	20	7	.752	7090
397.5	22	7	.762	8990
397.5	24	7	.772	11000
397.5	26	7	.783	13000
397.5	30	7	.806	17500
477.0	20	7	.823	8490
477.0	22	7	.834	10800
477.0	24	7	.846	13000

Size AWG or kcmil	# Alum Strands	# Steel Strands	Conductor Diameter	Rated Strength (pounds)
477.0	26	7	.858	15600
477.0	30	7	.883	21000
500.0	30	7	.904	22000
556.5	20	7	.890	9910
556.5	22	7	.901	12600
556.5	24	7	.914	15200
556.5	26	7	.927	18200
556.5	30	7	.953	24500
605.0	24	7	.953	16500
605.0	26	7	.966	19700
605.0	30	7	.994	26000
605.0	30	19	.994	26600
636.0	20	7	.951	11300
636.0	22	7	.963	14100
636.0	24	7	.977	17300
636.0	26	7	.990	20700
636.0	30	7	1.019	27400
636.0	30	19	1.019	28000

CABLE DATA

SSAC Cable (Continued)

Size AWG or kcmil	# Alum Strands	# Steel Strands	Conductor Diameter	Rated Strength (pounds)
666.6	24	7	1.000	18200
666.6	26	7	1.104	21700
715.5	24	7	1.036	19500
715.5	26	7	1.051	23300
715.5	30	19	1.081	30800
795.0	42	7	1.055	11800
795.0	20	7	1.063	14200
795.0	45	7	1.063	14200
795.0	22	7	1.077	17700
795.0	24	7	1.092	21700
795.0	54	7	1.092	21700
795.0	26	7	1.108	25900
795.0	30	19	1.140	34300
900.0	45	7	1.131	15800
900.0	54	7	1.162	24600
954.0	42	7	1.155	14200
954.0	20	7	1.185	16700
954.0	45	7	1.165	16700
954.0	48	7	1.175	19700
954.0	24	7	1.196	26000
954.0	54	7	1.196	26000
954.0	30	19	1.248	41100
1033.5	42	7	1.203	15400

Size AWG or kcmil	# Alum Strands	# Steel Strands	Conductor Diameter	Rated Strength (pounds)
1033.5	45	7	1.212	18100
1033.5	48	7	1.222	21300
1033.5	54	7	1.245	28200
1113.0	42	7	1.248	16300
1113.0	45	7	1.259	19500
1113.0	48	7	1.269	23000
1113.0	54	19	1.293	30400
1192.5	42	7	1.292	17500
1192.5	45	7	1.302	20900
1192.5	48	7	1.313	24600
1192.5	54	19	1.338	32600
1272.0	42	7	1.334	18700
1272.0	45	7	1.345	22300
1272.0	48	7	1.357	26200
1272.0	54	19	1.382	34100
1351.5	42	7	1.376	19900
1351.5	45	7	1.386	23700
1351.5	48	7	1.398	27900
1351.5	54	19	1.424	36200
1431.0	42	7	1.415	21000
1431.0	45	7	1.427	25100
1431.0	48	7	1.439	29500
1431.0	54	19	1.465	38400
1510.5	45	7	1.466	26500
1510.5	54	19	1.505	40500
1590.0	42	7	1.492	23400
1590.0	45	7	1.504	27900
1590.0	48	7	1.517	32200
1590.0	54	19	1.545	42600
1780.0	84	19	1.602	35400
1869.0	68	7	1.603	21500
2034.5	72	7	1.681	27200

CABLE DATA

Solid COPPERWELD® Cable (ASTM B227)

Conductor Size (AWG)	Nominal Diameter (inches)	Circular Mils	Minimum Breaking Load (pounds)			
			Grade 40 HS	Grade 40 EHS	Grade 30 HS	Grade 30 EHS
4	0.2043	41740	3540	-	3934	4671
5	0.1819	33090	2937	-	3249	3911
-	0.1650*	27230	2779	-	2779	3367
6	0.1620	26240	2679	-	2679	3246
7	0.1443	20820	2207	-	2207	2681
8	0.1285	16510	1816	-	1816	2205
-	0.1280*	16380	1802	-	1802	2188
9	0.1144	13090	1491	-	1491	1790
-	0.1040*	10820	1283	1325	1283	1487
10	0.1019	10380	1231	-	1231	1460
12	0.0808	6530	774	-	774	918
-	0.0800*	6400	759	-	759	900
-	0.0640*	4096	485	-	485	576
18	0.0403	1624	193	-	193	228
-	0.0390*	1521	180	-	180	214
20	0.0320	1024	121	-	121	144

* These diameters are often employed by purchasers for communication lines BUT are not in the American Wire Gauge (B&S Wire Gauge) series, as are the other diameter listed.

Stranded COPPERWELD® Cable (ASTM B228)

Nominal Diameter† (inch) Size AWG‡	Circular Mils	Diameter* (inch)	Breaking Load (pounds)**		
			High Strength		Extra High Strength
			40% Cond.	30% Cond.	30% Cond.
7/8 (19 No. 5)	628900	.910	50240	55570	66910
13/16 (19 No. 6)	498800	.810	41600	45830	55530
23/32 (19 No. 7)	395500	.721	34390	37740	45850
27/32 (19 No. 8)	313700	.642	28380	31040	37690
9/16 (19 No. 9)	248800	.572	23390	25500	30610
5/8 (7 No. 4)	292200	.613	22310	24780	29430
9/16 (7 No. 5)	231700	.546	18510	20470	24650
1/2 (7 No. 6)	183800	.486	15330	16890	20460
7/16 (7 No. 7)	145700	.433	12670	13910	16890
3/8 (7 No. 8)	115600	.385	10460	11440	13890
11/32 (7 No. 9)	91650	.343	8616	9393	11280
5/16 (7 No. 10)	72680	.306	7121	7758	9196
3 No. 5	99310	.392	8373	9262	11860
3 No. 6	78750	.349	6934	7639	9754
3 No. 7	62450	.311	5732	6291	7922
3 No. 8	49530	.277	4730	5174	6282
3 No. 9	39280	.247	3898	4250	5129
3 No. 10	31150	.220	3221	3509	4160
3 No. 12	19590	.174	2236	-	-

† The designation "inch" is the approximate diameter in proper fraction of an inch.

‡ The designation AWG is a combination of the number of wires each of the American Wire Gauge size indicated by "No."

* Diameter of circumscribing.

** Breaking loads of 7-wire and 19-wire conductors are taken as 90% of the sum of the breaking loads of individual wires; breaking load of 3-wire conductors is taken as 95% of the sum of the breaking loads of the individual wires.

CABLE DATA

COPPERWELD®-COPPER CABLE (ASTM B229)

Conductor size Hard Drawn Copper Equivalent			Nom. Dia. of Conductor (inches)	Min. Breaking Load (pounds)
cmil	AWG	Type		
350000	-	E	0.788	32420
350000	-	EK	0.735	23850
350000	-	V	0.754	23480
300000	-	E	0.729	27770
300000	-	EK	0.680	20960
300000	211600	V	0.698	20730
250000	-	E	0.666	23920
250000	-	EK	0.621	17840
250000	-	V	0.637	17420
	4/0	E	0.613	20730
211600	4/0	G	0.583	15640
211600	4/0	EK	0.571	15370
211600	4/0	V	0.586	15000
211600	4/0	F	0.550	12290
167800	3/0	E	0.545	16800
167800	3/0	J	0.555	16170
167800	3/0	G	0.519	12860
167800	3/0	EK	0.509	12370
167800	3/0	V	0.522	12200
167800	3/0	F	0.490	9980
133100	2/0	K	0.534	17600
133100	2/0	J	0.494	13430
133100	2/0	G	0.463	10510
133100	2/0	V	0.465	9846
133100	2/0	F	0.436	8094
105600	1/0	K	0.475	14490
105600	1/0	J	0.440	10970
105600	1/0	G	0.412	8563
105600	1/0	F	0.388	6536
83690	1	N	0.464	15410
83690	1	K	0.423	11900
83690	1	J	0.392	9000
83690	1	G	0.367	6956
83690	1	F	0.346	5266
66360	2	P	0.462	16870
66360	2	N	0.413	12680
66360	2	K	0.377	9730
66360	2	J	0.349	7322

Conductor size Hard Drawn Copper Equivalent			Nom. Dia. of Conductor (inches)	Min. Breaking Load (pounds)
cmil	AWG	Type		
66360	2	A	0.366	5876
66360	2	G	0.327	5626
66360	2	F	0.308	4233
55620	3	P	0.411	13910
52620	3	N	0.368	10390
52620	3	K	0.336	7910
52620	3	J	0.311	5955
52620	3	A	0.326	4810
41740	4	P	0.366	11420
41740	4	N	0.328	8460
41740	4	D	0.348	7340
41740	4	A	0.290	3938
33090	5	P	0.326	9311
33090	5	D	0.310	6035
33090	5	A	0.258	3193
26240	6	D	0.276	4942
26240	6	A	0.230	2585
26240	6	C	0.225	2143
20820	7	D	0.246	4022
20820	7	A	0.223	2754
16510	8	D	0.219	3256
16510	8	A	0.199	2233
16510	8	C	0.179	1362
11750	9	D	0.174	1743

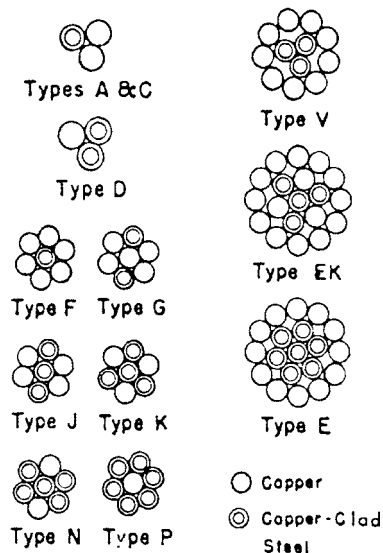

CABLE DATA

GALVANIZED STEEL CABLE (ASTM A475)

inches	Nom. Dia. of Strand (mm)	Number of Wires in Strand	Minimum Breaking Load (pounds)				
			Utilities Grade	Common Grade	Siemens-Martin Grade	High-Strength Grade	Extra High-Strength Grade
1/8	3.18	7	-	540	910	1330	1830
5/32	3.97	7	-	870	1470	2140	2940
3/16	4.76	7	-	1150	1900	2850	3990
3/16	4.76	7	2400	-	-	-	-
7/32	5.56	3	-	1400	2340	3500	4900
7/32	5.56	7	-	1540	2560	3850	5400
1/4	6.35	3	3150	1860	3040	4730	6740
1/4	6.35	3	4500	-	-	-	-
1/4	6.35	7	-	1900	3150	4750	6650
9/32	7.14	3	-	2080	3380	5260	7500
9/32	7.14	7	4600	2570	4250	6400	8950
5/16	7.94	3	6500	2490	4090	6350	9100
5/16	7.94	7	-	3200	5350	8000	11200
5/16	7.94	7	6000	-	-	-	-
3/8	9.52	3	8500	3330	5560	8360	11800
3/8	9.52	7	11500	4250	6950	10800	15400
7/16	11.11	7	18000	5700	9350	14500	20800
1/2	12.70	7	25000	7400	12100	18800	26900
1/2	12.70	19	-	7620	12700	19100	26700
9/16	14.29	7	-	9600	15700	24500	35000
9/16	14.29	19	-	9640	16100	24100	33700
5/8	15.88	7	-	11600	19100	29600	42400
5/8	15.88	19	-	11000	18100	28100	40200
3/4	19.05	19	-	16000	26200	40800	58300
7/8	22.22	19	-	21900	35900	55800	79700
1	25.40	9	-	28700	47000	73200	104500
1	25.40	37	-	28300	46200	71900	102700
1-1/8	28.58	37	-	36000	58900	91600	130800
1-1/4	31.75	37	-	44600	73000	113600	162200















CABLE DATA







ALUMINUM-COATED STEEL CABLE (ASTM A474)

Nom. Dia. of Strand (inches)	Number of Wires in Strand	Minimum Breaking Strength (pounds)				
		Utilities Grade*	Common Grade	Siemens-Martin Grade	High-Strength Grade	Extra High-Strength Grade
3/16	7		1150	1900	2850	
3/16	7	2400				
1/4	3	3150				
1/4	3	4500				
1/4	7		1900	3150	4750	6650
9/32	7	4600				
5/16	3	6500				
5/16	7		3200	5350	8000	11200
5/16	7	6000				
3/8	3	8500				
3/8	7	11500	4250	6950	10800	15400
7/16	7	18000	5350	9350	14500	20800
1/2	7	25000	7400	12100	18800	26900

* The Utilities Grade is used principally by communications and power and light industries.

TERMINAL STUD SIZE CHART*

STUD SIZE	#0	#1	#2	#3	#4	#5	#6	#8	#10	#12	#14	1/4"	5/16"	3/8"
Stud Diameter	.060	.073	.086	.090	.112	.125	.138	.164	.190	.216	.242	.250	.312	.375
														
Stud Hole	.067	.093	.119			.145		.171	.197	.223	.250	17/64	21/64	25/64

STUD SIZE	7/16"	1/2"	5/8"	3/4"	7/8"	1"
Stud Diameter	.437	.500	.625	.750	.875	1.000
						
Stud Hole	29/64	33/64	21/32	29/32	29/32	1 - 1/32

*Tolerance .003" on decimal and .005" on fractional dimensions

AWG VS. METRIC WIRE SIZES

Circ. Mils	Equivalent Circ. Mils	AWG Size	Metric Wire Size (mm)	Number of Strands	Wire Dia. per Strand		Approx. Overall Diameter	
					inches	mm	inches	mm
-	937	-	.50	1	.032	.813	.032	.81
1020	-	20	-	7	.0121	.307	.036	.91
-	1480	-	.75	1	.039	.091	.039	.99
1620	-	18	-	1	.0103	1.02	.040	1.02
1620	-	18	-	7	.0152	.386	.046	1.16
-	1974	-	1.0	1	.045	1.14	.045	1.14
-	1974	-	1.0	7	.017	.422	.061	1.30
2580	-	16	-	1	.0503	1.29	.051	1.29
2580	-	16	-	7	.0192	.468	.058	1.46
-	2960	-	1.5	1	.055	1.40	.055	1.40
-	2960	-	1.5	7	.021	5.33	.063	1.60
4110	-	14	-	1	.0641	1.63	.064	1.63
4110	-	14	-	7	.0242	.615	.073	1.84
-	4934	-	2.5	1	.071	1.80	.071	1.80
-	4934	-	2.5	7	.027	6.66	.081	2.06
6530	-	12	-	1	.0308	2.05	.081	2.05
6530	-	12	-	7	.0305	.775	.092	2.32
-	7894	-	4	1	.089	2.26	.089	2.26
-	7894	-	4	7	.034	.864	.102	2.59
10380	-	10	-	1	.1019	2.59	.102	2.59
10380	-	10	-	7	.0355	.978	.116	2.93
-	11840	-	6	1	.109	2.77	.109	2.77
-	11840	-	6	7	.042	.107	.126	3.21
13000	-	9	-	1	.1144	2.91	.114	2.91
13090	-	9	-	7	.0432	1.10	.130	3.30
16510	-	8	-	1	.1285	3.26	.128	3.25
16510	-	8	-	7	.0486	1.23	.146	3.70
-	19740	-	10	1	.141	3.58	.141	3.58
-	19740	-	10	7	.054	1.37	.162	4.12
20520	-	7	-	1	.1443	3.67	.144	3.67
20520	-	7	-	7	.0545	1.38	.164	4.15
26240	-	6	-	1	.162	4.11	.162	4.11
26240	-	6	-	7	.0612	1.55	.184	4.66
-	31580	-	16	7	.008	1.73	.204	5.13
33090	-	5	-	7	.0688	1.75	.206	5.24
41740	-	4	-	7	.0772	1.96	.232	5.88
-	49340	-	25	7	.085	2.16	.255	6.48
-	49340	-	25	19	.052	1.32	.260	6.60
52620	-	3	-	7	.0867	2.20	.260	6.61
66300	-	2	-	7	.0974	2.47	.292	7.42

AWG VS. METRIC WIRE SIZES (continued)

Circ. Mils	Equivalent Circ. Mils	AWG Size	Metric Wire Size (mm)	Number of Strands	Wire Dia. per Strand		Approx. Overall Diameter	
					inches	mm	inches	mm
-	69070	-	35	7	.100	2.54	.300	7.62
-	69070	-	35	19	.001	1.55	.305	7.75
83690	-	1	-	19	.0064	1.50	.332	8.43
-	98680	-	50	19	.073	1.85	.365	9.27
105000	-	1/0	-	19	.0745	1.59	.373	9.46
133100	-	2/0	-	19	.0837	2.13	.419	10.6
-	138100	-	70	19	.086	2.18	.430	10.9
167800	-	3/0	-	19	.094	2.59	.470	11.9
167800	-	3/0	-	36	.0673	1.71	.471	12.0
-	187500	-	95	19	.101	2.57	.505	12.8
-	187500	-	95	37	.072	1.83	.504	12.5
211600	-	4/0	-	19	.1055	2.89	.528	13.4
-	237.8 kcmil	-	120	37	.081	2.06	.567	14.4
250 kcmil	-	-	-	37	.0822	2.07	.575	14.6
300 kcmil	-	-	150	37	.090	2.29	.630	16.0
350 kcmil	-	-	-	37	.0973	2.47	.681	17.3
-	365.1 kcmil	-	185	37	.100	2.54	.700	17.8
400 kcmil	-	-	-	37	.104	2.64	.728	18.5
-	473.6 kcmil	-	240	37	.114	2.90	.798	20.3
-	473.6 kcmil	-	240	61	.089	2.26	.801	20.3
500 kcmil	-	-	-	37	.1162	2.95	.813	20.7
500 kcmil	-	-	-	61	.0905	2.30	.814	20.7
-	592.1 kcmil	-	300	61	.099	2.51	.891	22.6
600 kcmil	-	-	-	61	.0992	2.52	.893	22.7
700 kcmil	-	-	-	61	.1071	2.72	.964	24.5
750 kcmil	-	-	-	6	.1109	2.82	.998	25.4
750 kcmil	-	-	-	91	.0908	2.31	.998	25.4
-	789.4 kcmil	-	400	61	.114	2.90	1.026	26.1
800 kcmil	-	-	-	61	.1145	2.91	1.031	26.2
800 kcmil	-	-	-	91	.0938	2.38	1.032	26.2
1000 kcmil	986.8 kcmil	-	500	61	.1280	3.25	1.152	28.3
1000 kcmil	-	-	-	91	.1048	2.66	1.153	29.3
-	1233.7 kcmil	-	625	91	.117	2.97	1.287	32.7
1250 kcmil	-	-	-	91	.1172	2.93	1.289	32.7
1250 kcmil	-	-	-	127	.0992	2.52	1.200	32.8
1500 kcmil	-	-	-	91	.1284	3.26	1.412	36.9
1500 kcmil	-	-	-	127	.1087	2.76	1.413	36.9
-	1578.8 kcmil	-	800	91	.132	3.35	1.452	36.9
-	1973.5 kcmil	-	1000	91	.147	3.73	1.617	41.1
2000 kcmil	-	-	-	127	.1255	3.19	1.632	41.5
2000 kcmil	-	-	-	169	.1088	2.76	1.632	41.5

INCHES & MILLIMETERS CONVERSION CHART

INCHES		MM	INCHES		MM	MM	INCHES	MM	INCHES
$\frac{1}{64}$.015625	0.397	$\frac{33}{64}$.515625	13.097	.1	.0039	46	1.8110
$\frac{1}{32}$.03125	0.794	$\frac{17}{32}$.53125	13.494	.2	.0079	47	1.8504
$\frac{3}{64}$.046875	1.191	$\frac{35}{64}$.546875	13.891	.3	.0118	48	1.8898
$\frac{1}{16}$.0625	1.588	$\frac{9}{16}$.5625	14.288	.4	.0157	48	1.9291
$\frac{5}{64}$.078125	1.984	$\frac{37}{64}$.578125	14.684	.5	.0197	50	1.9685
$\frac{3}{32}$.09375	2.381	$\frac{19}{32}$.59375	15.081	.6	.0236	51	2.0079
$\frac{7}{64}$.109375	2.778	$\frac{39}{64}$.609375	15.478	.7	.0276	52	2.0472
$\frac{1}{8}$.1250	3.175	$\frac{5}{8}$.6250	15.875	.8	.0315	53	2.0866
$\frac{9}{64}$.140625	3.572	$\frac{41}{64}$.640625	16.272	.9	.0354	54	2.1260
$\frac{5}{32}$.15625	3.969	$\frac{21}{32}$.65625	16.669	1	.0394	55	2.1654
$\frac{11}{64}$.171875	4.366	$\frac{43}{64}$.671875	17.066	2	.0787	56	2.2047
$\frac{3}{16}$.1875	4.763	$\frac{11}{16}$.6875	17.463	3	.1181	57	2.2441
$\frac{13}{64}$.203125	5.159	$\frac{45}{64}$.703125	17.859	4	.1575	58	2.2835
$\frac{7}{32}$.21875	5.556	$\frac{23}{32}$.71875	18.256	5	.1969	59	2.3228
$\frac{15}{64}$.234375	5.953	$\frac{47}{64}$.734375	18.653	6	.2362	60	2.3622
$\frac{1}{4}$.2500	6.350	$\frac{3}{4}$.7500	19.050	7	.2756	61	2.4016
$\frac{17}{64}$.265625	6.747	$\frac{49}{64}$.765625	19.447	8	.3150	62	2.4409
$\frac{9}{32}$.28125	7.144	$\frac{25}{32}$.78125	19.844	9	.3543	63	2.4803
$\frac{19}{64}$.296875	7.541	$\frac{51}{64}$.796875	20.241	10	.3937	64	2.5197
$\frac{5}{16}$.3125	7.938	$\frac{13}{16}$.8125	20.638	11	.4331	65	2.5591
$\frac{21}{64}$.328125	8.334	$\frac{53}{64}$.828125	21.034	12	.4724	66	2.5984
$\frac{11}{32}$.34375	8.731	$\frac{27}{32}$.84375	21.431	13	.5118	67	2.6378
$\frac{23}{64}$.359375	9.128	$\frac{55}{64}$.859375	21.828	14	.5512	68	2.6772
$\frac{3}{8}$.3750	9.525	$\frac{7}{8}$.8750	22.225	15	.5906	69	2.7165
$\frac{25}{64}$.390625	9.922	$\frac{57}{64}$.890625	22.622	16	.6299	70	2.7559
$\frac{13}{32}$.40625	10.319	$\frac{29}{32}$.90625	23.019	17	.6693	71	2.7953
$\frac{27}{64}$.421875	10.716	$\frac{59}{64}$.921875	23.416	18	.7087	72	2.8346
$\frac{7}{16}$.4375	11.113	$\frac{15}{16}$.9375	23.813	19	.7480	73	2.8740
$\frac{29}{64}$.453125	11.509	$\frac{61}{64}$.953125	24.209	20	.7874	74	2.9134
$\frac{15}{32}$.46875	11.906	$\frac{31}{32}$.96875	24.606	21	.8268	75	2.9528
$\frac{31}{64}$.484375	12.303	$\frac{63}{64}$.984375	25.003	22	.8661	76	2.9921
$\frac{1}{2}$.5000	12.700	1	1.000	25.400	23	.9055	77	3.0315
						24	.9449	78	3.0709
						25	.9843	79	3.1102
						26	1.0236	80	3.1496
						27	1.0630	81	3.1890
						28	1.1024	82	3.2283
						29	1.1417	83	3.2677
						30	1.1811	84	3.3071
						31	1.2205	85	3.3465
						32	1.2598	86	3.3858
						33	1.2992	87	3.4252
						34	1.3386	88	3.4646
						35	1.3780	89	3.5039
						36	1.4173	90	3.5433
						37	1.4567	91	3.5827
						38	1.4961	92	3.6220
						39	1.5354	93	3.6614
						40	1.5748	94	3.7008
						41	1.6142	95	3.7402
						42	1.6535	96	3.7795
						43	1.6929	97	3.8189
						44	1.7323	98	3.8583
						45	1.7717	99	3.8976
								100	3.9370

BURNDY CONDUCTOR NUMBERING SYSTEM - © BURNDY ENGINEERING CO., INC., 1940

Outside Dia. IN	Outside Dia. MM	STR. CABLE		SOL. WIRE		AREA MM ² Copper Cable	ACSR		PIPE SIZE CONDUCTOR				TUBE & ROD		SERVIT NO.
		Cat. No.	Size	Cat. No.	Size		Cat. No.	Cable Size	Cat. No.	ST D	Cat. No.	Ex Hvy	Cat. No.	Dia.	
.102	2.594			10W	10	5.261									KS90
.114	2.896			9W	9	6.634									
.116	2.946	10 C	10			5.261									
.125	3.175											60	1/8		
.129	3.277			8W	8	8.366									KS15
.130	3.302	9 C	9			6.634									
.144	3.658			7W	7	10.550									
.146	3.708	8 C	8			8.366									
.158	4.013						8R	8							
.162	4.115			6W	6	13.300									KS17
.164	4.166	7 C	7			10.550									
.176	4.470						7R	7							
.182	4.597			5W	5	16.770									
.184	4.648	6 C	6			13.300									
.198	5.029						6R	6							
.204	5.182			4W	4	21.150									KS20
.206	5.258	5 C	5			16.770									
.223	5.664						5R	5							
.229	5.817			3W	3	26.670									
.232	5.867	4 C	4			21.150									
.250	6.350						4R	4				61	1/4		
.258	6.553			2W	2	33.630									KS22
.260	6.629	3 C	3			2.6670									
.281	7.137						3R	3							
.289	7.344			1W	1	42.410									
.292	7.394	2 C	2			33.630									KS23
.316	8.026						2R	2							
.325	8.255			75	1/0	53.480									
.332	8.382	1 C	1			42.410									
.355	9.017						1R	1							
.365	9.274			76	2/0	67.430									
.372	9.474	25	1/0			53.480									KS25
.375	9.525											62	3/8		
.398	10.109						25R	1/0							
.405	10.287								10	1/8	50	1/8			
.410	10.414			77	3/0	85.030									
.419	10.617	26	2/0			67.430									KS26
.447	11.354						26R	2/0							
.460	11.684			78	4/0	107.200									
.470	11.938	27	3/0			85.030									
.500	12.700											63	1/2		
.502	12.725						27R	3/0							
.528	13.414	28	4/0			107.200									KS28
.540	13.716								11	1/4	51	1/4			
.563	14.326						28R	4/0							
.575	14.605	29	250			127.000									
.630	16.002	30	300			152.000									
.633	16.078						29R	266.800							
.642	16.307						30R	266.800							
.675	17.145								12	3/8	52	3/8			
.680	17.272						31R	300.000							
.681	17.297	31	350			177.000									KS31
.721	18.313						32R	336.400							
.728	18.494	32	400			203.000									
.741	18.824						33R	336.400							
.750	19.050											64	3/4		
.772	19.609	33	450			228.000									
.783	19.888						34R	397.500							
.806	20.472						35R	397.500							
.813	20.676	34	500			253.000									
.840	21.336								13	1/2	53	1/2			
.855	21.717	35	550			279.000									KS34
.858	21.742						36R	477.000							
.883	22.428						37R	477.000							
.893	22.682	36	600			304.000									
.904	22.962						38R	500.000							
.927	23.546						39R	556.500							
.929	23.597	37	650			329.000									
.953	24.206						40R	556.500							
.953	24.206						41R	605.000							
.964	24.486	38	700			355.000									
.977	24.714						42R	636.000							
.998	25.349	39	750			380.000									KS39
1.000	25.400						43R	666.600				65	1		

BURNDY CONDUCTOR NUMBERING SYSTEM (continued)

Outside Dia. IN	Outside Dia. MM	STR. CABLE		SOL. WIRE		AREA MM ² Copper Cable	ACSR		PIPE SIZE CONDUCTOR				TUBE & ROD		SERVIT NO.
		Cat. No.	Size	Cat. No.	Size		Cat. No.	Cable Size	Cat. No.	ST D	Cat No.	Ex Hvy	Cat. No.	Dia.	
1.031	26.187	40	800			405.000									
1.036	26.314						44R	715,500							
1.050	26.670								14		54				
1.062	26.975	41	850			431.000									
1.094	27.762	42	900			456.000	45R	795,000							
1.123	28.524	43	950			481.000									
1.146	29.108						46R	874,000							
1.152	29.264	44	1000			507.000									KS44
1.162	29.515						47R	900,000							
1.196	30.378						48R	954,000							
1.209	30.709	444	1100			557.000									
1.246	31.648						49R	1,033,500							
1.250	31.750												66	1	
1.263	32.080	448	1200			608.000									
1.289	32.744	45	1250			633.000									
1.293	32.817						50R	1,113,000							
1.315	33.404	452	1300						15	1	55	1			
1.338	33.960						51R	1,192,500							
1.364	34.646	456	1400			709.000									
1.382	35.103						52R	1,272,000							
1.412	35.865	46	1500			760.000									
1.424	36.170						53R	1,351,500							
1.459	37.059	464	1600			811.000									
1.465	37.214						54R	1,431,000							
1.500	38.100												67	1-1/2	
1.504	38.202	468	1700			861.000									
1.506	38.252						55R	1,510,500							
1.526	38.786	47	1750			866.000									
1.545	39.218						56R	1,590,000							
1.548	39.319	472	1800			912.000									
1.590	40.386	476	1900			963.000									
1.632	41.427	48	2000			1013.00									
1.660	42.164								16	1	56	1			
1.729	43.917	483	2250			1140.000									
1.824	46.330	486	2500			1267.000									
1.900	48.260								17	1-1/2	57	1-1/2			
1.914	48.616	490	2750			1393.000									
1.988	50.495	493	3000			1520.000									
2.000	50.800												68	2	
2.375	60.325								18	2	58	2			
2.500	63.500												69	2-1/2	
2.875	73.025								19	2-1/2	59	2-1/2			
3.000	76.200												70	3	
3.500	88.900								20	3	90	3	71	3-1/2	
4.000	101.600								21	3-1/2	91	3-1/2	72	4	
4.500	114.300								22	4	92	4	73	4-1/2	
5.000	127.000								23	4-1/2	93	4-1/2	74	5	
5.563	141.300								24	5	94	5			
6.063	154.000								85	5-1/2	95	5-1/2			
6.625	168.275								86	6	96	6			
7.625	193.675								87	7	97	7			
8.625	219.075								88	8	98	8			

DIE INDEX REFERENCE

This chart provides a cross reference between die index numbers marked on BURNDY® Compression Connectors and corresponding BURNDY® Die Sets used with the various BURNDY® Installation Tools.

This is the only way to have complete connections with The BURNDY® Engineered System.

A die index number has been assigned to each required groove configuration. A prefix letter is used to indicate the specific installation tool for which the die has been designed, as shown.

DIE PROFILES

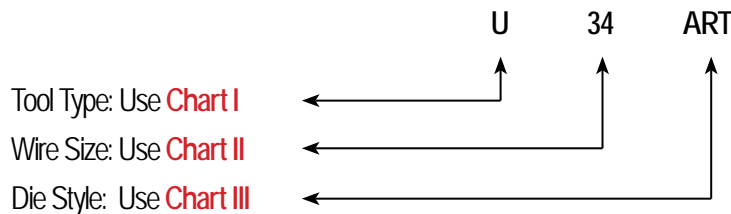
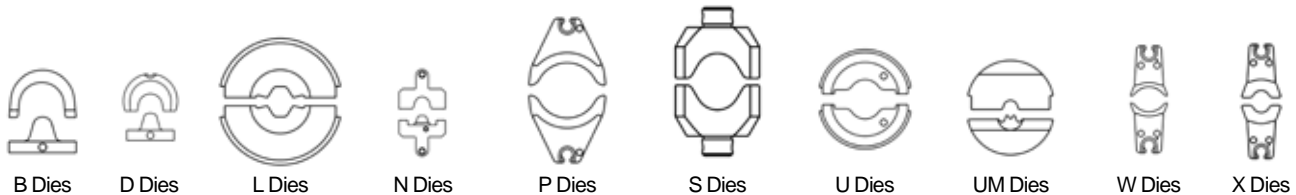

CHART I - Tool Type

B = Y34BH	U = 35 and 750 Series, 46 Series w/PUADP1 U-die Adapter
D = Y29BH	
L = 60 Series	UM = OEM840NCP, 750 Series, 46 Series w/PUADP1 U-die Adapter
N = M8ND	
P = 46 Series	W = MD and PATMD Series, PAT500SJ, PAT600
S = Y45	X = MD6 and MD7 Series, OUR840

CHART II - Wire Size

12 = #12 AWG	27 = 3/0
10 = #10 AWG	28 = 4/0
8C = #8 AWG	29 = 250 kcmil
6C = #6 AWG	30 = 300 kcmil
5C = #5 AWG	31 = 350 kcmil
4C = #4 AWG	32 = 400 kcmil
3C = #3 AWG	34 = 500 kcmil
2C = #2 AWG	36 = 600 kcmil
1C = #1 AWG	39 = 750 kcmil
25 = 1/0	44 = 1000 kcmil
26 = 2/0	

Or **INDEX NUMBER**: Example U312 = **312** Die Index

CHART III - Die Style

A = Aluminum
R = Round (circumferential)
T = Twin Die (both halves)

Footnotes for the chart in the following pages:

- ① - Cat. No. Y35P3 Adapter is required to use "Y34PR" type indenters with "U" type nest dies in 35 and 750 Series
- ② - Cat. No. PT6515 Adapter is required to use "U" type dies in 45 Series
- ③ - Cat. No. PUADP1 Adapter is required to use "U" type dies in 46 Series
- ④ - These sizes (250 - 500 kcmil) are not recommended for use with MD6 & MD7 Series tools due to high handle force
- ⑤ - Hexagonal crimp
- ⑥ - Die 302 recommended for 1.84 O.D. barrel
- - Index 302 Dieless can only be crimped with the 444S Series, Y644MBH or Y644MBHF

PRESENT INSTALLATION TOOL INDEX

DIE GROOVE		DIE INFORMATION		DIELESS TOOLS		INSTALLATION TOOLING USING DIES							
BURNDY	EEl	TYPE	COLOR	MR, MY	444S/644 Series	MD/PATMD Series	OUR840	Y29BH	35 ① Series	750 ① Series	Y45 ②	46 ③ Series	60 Series
A		DIE SET							UA	UA	UA	UA	
BG		DIE SET				Perm. GR WBG	XBG XNBG		UBG	UBG	UBG	UBG	
C		DIE SET	BROWN			WC			UC	UC	UC	UC	
D		DIE SET							UD	UD	UD	UD	
D3		DIE SET	BLUE						UYFD	UYFD	UYFD	UYFD	
						Perm. GR			UD3	UD3	UD3	UD3	
E		DIE SET							UE	UE	UE	UE	
F		DIE SET							UF	UF	UF	UF	
H		DIE SET							UH	UH	UH	UH	
K1/4		DIE SET				WK14							
K5/16		DIE SET				WK516			UK516T	UK516T	UK516T	UK516T	
K3/8		DIE SET				WK38			UK38T	UK38T	UK38T	UK38T	
K1/2		DIE SET				WK12							
K9/16		DIE SET				WK916			UK916T	UK916T	UK916T	UK916T	
K19/32		DIE SET				WK1932							
K5/81		DIE SET							UK581T	UK581T	UK581T	UK581T	
K11/16		DIE SET				WK1116			UK1116T	UK1116T	UK1116T	UK1116T	
K3/4		DIE SET							UK34T	UK34T	UK34T	UK34T	
K1		DIE SET							UK1T	UK1T	UK1T	UK1T	
K15/16		DIE SET							UK1516T	UK1516T	UK1516T	UK1516T	
K635		DIE SET				WK737			UK737T	UK737T	UK737T	UK737T	
K747		DIE SET				WK747							
K781		DIE SET				WK781							
K840		DIE SET				WK840			UK840T	UK840T	UK840T	UK840T	
KB		DIE SET				WKB			UKBT	UKBT	UKBT	UKBT	
KBKT		DIE SET							UKBKTT	UKBKTT	UKBKTT	UKBKTT	
KC		DIE SET							UKCT	UKCT	UKCT	UKCT	
KK		DIE SET				WKK							
KR		DIE SET	YELLOW									PYFR	
											SKR	PKR	
KT		DIE SET				WKT							
KU		DIE SET							UKUT	UKUT	UKUT	UKUT	
L		DIE SET				WL			UL	UL	UL	UL	
L80		DIE SET							U32XRT	U32XRT	U32XRT	U32XRT	
L99		DIE SET	PINK						U38XRT	U38XRT	U38XRT	U38XRT	
L115		DIE SET	YELLOW						U44XRT	U44XRT	U44XRT	U44XRT	
M		DIE SET							UM	UM	UM	UM	
N		DIE SET	RED						UYFN	UYFN	UYFN	UYFN	
									UN	UN	UN	UN	

See Footnotes preceding the table.

PRESENT INSTALLATION TOOL INDEX

DIE		DIE INFORMATION		DIELESS TOOLS		INSTALLATION TOOLING USING DIES							
GROOVE		TYPE	COLOR	MR, MY	444S/644 Series	MD/PATMD Series	OUR840	Y29BH	35 ① Series	750 ① Series	Y45 ②	46 ③ Series	60 Series
BURNDY	EEl												
O		DIE SET	GREEN						UYFO	UYFO	UYFO	UYFO	
						Perm. GR WO			UO	UO	UO	UO	
Q		DIE SET				WQ							
R		DIE SET							UR	UR	UR	UR	
T		DIE SET									ST		
Z		DIE SET									SZ		
7 94		DIE SET	BLUE	MR4C MY293 MY2911	1 CRIMP	W5CRT	X5CRT		U5CRT	U5CRT	U5CRT	U5CRT	
		NEST						D6CL	U6CD1	U6CD1	U6CD1	U6CD1	
		INDENTOR						Y29PR	Y34PR	Y34PR	Y34PR	Y34PR	
8 95		DIE SET	GRAY	MR4C MY293 MY2911	1 CRIMP	W4CRT	X4CRT		U4CRT	U4CRT	U4CRT	U4CRT	
		NEST						D4CL	U4CD1	U4CD1	U4CD1	U4CD1	
		INDENTOR						Y29PR	Y34PR	Y34PR	Y34PR	Y34PR	
9 96		DIE SET	WHITE	MY293 MY2911	1 CRIMP	W3CRT	X3CRT		U3CRT	U3CRT	U3CRT	U3CRT	
		NEST						D3CL	U3CD1	U3CD1	U3CD1	U3CD1	
		INDENTOR						Y29PR	Y34PR	Y34PR	Y34PR	Y34PR	
10 97		DIE SET	BROWN	MY293 MY2911	1 CRIMP	W2CRT	X2CRT		U2CRT	U2CRT	U2CRT	U2CRT	
		NEST						D2CL	U2CD1	U2CD1	U2CD1	U2CD1	
		INDENTOR						Y29PR	Y34PR	Y34PR	Y34PR	Y34PR	
11 98		DIE SET	GREEN	MY293 MY2911	1 CRIMP	W1CRT1	X1CRT1		U1CRT1	U1CRT1	U1CRT1	U1CRT1	
		NEST						D1CL	U1CD1	U1CD1	U1CD1	U1CD1	
		INDENTOR						Y29PR	Y34PR	Y34PR	Y34PR	Y34PR	
12 99		DIE SET	PINK	MY293 MY2911	1 CRIMP	W25RT	X25RT		U25RT	U25RT	U25RT	U25RT	
		NEST						D25L	U25D1	U25D1	U25D1	U25D1	
		INDENTOR						Y29PR	Y34PR	Y34PR	Y34PR	Y34PR	
13 100		DIE SET	BLACK	MY293 MY2911	1 CRIMP	W26RT	X26RT		U26RT	U26RT	U26RT	U26RT	
		NEST						D26L	U26D1	U26D1	U26D1	U26D1	
		INDENTOR						Y29PR	Y34PR	Y34PR	Y34PR	Y34PR	
14 101		DIE SET	ORANGE	MY293 MY2911	1 CRIMP	W27RT	X27RT		U27RT	U27RT	U27RT	U27RT	
		NEST						D27L	U27D1	U27D1	U27D1	U27D1	
		INDENTOR						Y29PR	Y34PR	Y34PR	Y34PR	Y34PR	
15		DIE SET	PURPLE	MY293 MY2911	1 CRIMP	W28RT	X28RT		U28RT	U28RT	U28RT	U28RT	
		NEST						D28L	U28D1	U28D1	U28D1	U28D1	
		INDENTOR						Y29PR	Y34PR	Y34PR	Y34PR	Y34PR	
16		DIE SET	YELLOW	MY293 MY2911	1 CRIMP	W29RT ④	X29RT		U29RT	U29RT	U29RT	U29RT	
		NEST						D29L		U29D1	U29D1	U29D1	
		INDENTOR						Y29PR		Y34PR	Y34PR	Y34PR	
17		DIE SET	WHITE		1 CRIMP	W30RT ④			U30RT	U30RT	U30RT	U30RT	L30RT
		NEST								U30D1	U30D1	U30D1	
		INDENTOR								Y34PR	Y34PR	Y34PR	

See Footnotes preceding the table.

PRESENT INSTALLATION TOOL INDEX

DIE GROOVE		DIE INFORMATION		DIELESS TOOLS		INSTALLATION TOOLING USING DIES							
BURNDY	EEI	TYPE	COLOR	MR, MY	444S/644 Series	MD/PATMD Series	OUR840	Y29BH	35 ① Series	750 ① Series	Y45 ②	46 ③ Series	60 Series
18		DIE SET	RED		1 CRIMP	W31RT ④			U31RT	U31RT	U31RT	U31RT	L31RT
		NEST							U31D1	U31D1	U31D1		
		INDENTOR							Y34PR	Y34PR	Y34PR		
19		DIE SET	BLUE		1 CRIMP	W32RT ④			U32RT	U32RT	U32RT	U32RT	L32RT
		NEST							U32D1	U32D1	U32D1		
		INDENTOR							Y34PR	Y34PR	Y34PR		
20		DIE SET	BROWN		1 CRIMP	W34RT ④			U34RT	U34RT	U34RT	U34RT	L34RT
		NEST							U34D1	U34D1	U34D1		
		INDENTOR							Y34PR	Y34PR	Y34PR		
21		DIE SET	YELLOW		1 CRIMP					U35RT	U35RT	U35RT	
		NEST											
		INDENTOR											
22		DIE SET	GREEN		1 CRIMP					U36RT	U36RT	U36RT	L36RT
		NEST									P36D		
		INDENTOR									P44PR		
23		DIE SET	ORANGE		1 CRIMP					U37RT	U37RT	U37RT	
		NEST											
		INDENTOR											
24		DIE SET	BLACK		1 CRIMP					U39RT	S39RT	P39RT	L39RT
		NEST									P39D		
		INDENTOR									P44PR		
25		DIE SET	ORANGE		1 CRIMP						S40RT	P40RT	
		NEST									P40D		
		INDENTOR									P44PR		
26		DIE SET	GOLD		1 CRIMP								
		NEST											
		INDENTOR											
27		DIE SET	WHITE		1 CRIMP						S44RT	P44RT	L44RT
		NEST									P44D		
		INDENTOR									P44PR		
29		DIE SET	YELLOW									P45RT	L45RT
		NEST											
		INDENTOR											
30		DIE SET	ORANGE										
		NEST											
		INDENTOR											
31		DIE SET	GREEN								S46RT	P46RT	L46RT
		NEST									No Nest		
		INDENTOR									P44PR		

See Footnotes preceding the table.

PRESENT INSTALLATION TOOL INDEX

DIE		DIE INFORMATION		DIELESS TOOLS		INSTALLATION TOOLING USING DIES							
GROOVE		TYPE	COLOR	MR, MY	444S/644 Series	MD/PATMD Series	OUR840	Y29BH	35 ① Series	750 ① Series	Y45 ②	46 ③ Series	60 Series
BURNDY	EEl												
33		DIE SET	GRAY										L47RT
		NEST											
		INDENTOR											
34		DIE SET	BROWN										L48RT
		NEST											
		INDENTOR											
38		NEST		MR4C MR8G98 MR89Q MY28 Y8MRB1				DV8L	UV8L	UV8L	UV8L	UV8L	
		INDENTOR						Y29PL	Y34PL	Y34PL	Y34PL	Y34PL	Y34PL
39		NEST		MR4C MY28	1 CRIMP			DV6L	UV6L	UV6L	UV6L	UV6L	
		INDENTOR						Y29PL	Y34PLA	Y34PLA	Y34PLA	Y34PLA	Y34PLA
40		NEST		MR4C MY28				DV4L	UV4L	UV4L	UV4L	UV4L	
		INDENTOR						Y29PL	Y34PLA	Y34PLA	Y34PLA	Y34PLA	Y34PLA
41		NEST		MY28				DV2L	UV2L	UV2L	UV2L	UV2L	
		INDENTOR						Y29PL	Y34PLA	Y34PLA	Y34PLA	Y34PLA	Y34PLA
42		NEST		MY28				DV1L	UV1L	UV1L	UV1L	UV1L	
		INDENTOR						Y29PL	Y34PLA	Y34PLA	Y34PLA	Y34PLA	Y34PLA
43		NEST		MY28				DV25L	UV25L	UV25L	UV25L	UV25L	
		INDENTOR						Y29PL	Y34PA	Y34PA	Y34PA	Y34PA	Y34PA
44		NEST		MY28				DV26L	UV26L	UV26L	UV26L	UV26L	
		INDENTOR						Y29PL	Y34PA	Y34PA	Y34PA	Y34PA	Y34PA
45		NEST		MY28					UV27L	UV27L	UV27L	UV27L	
		INDENTOR							Y34PA	Y34PA	Y34PA	Y34PA	Y34PA
46		NEST		MY28					UV28L	UV28L	UV28L	UV28L	
		INDENTOR							Y34PA	Y34PA	Y34PA	Y34PA	Y34PA
49		DIE SET	RED			W8CRT	X8CRT		U8CRT	U8CRT	U8CRT	U8CRT	
161		DIE SET				W161	X161		U161	U161	U161	U161	
162		DIE SET				W162	W162		U162	U162	U162	U162	
163 505		DIE SET				W163	W163		U163	U163	U163	U163	
164 275		DIE SET				W164			U164	U164	U164	U164	
165 205 287 339		DIE SET				W165	X165		U165/ U205	U165/ U205	U165/ U205	U165/U205	L165
166 206 459		DIE SET				W166			U166/ U459	U166/ U459	U166/ U459	U166/U459	L166
167 207 211 256 568		DIE SET				W167			U167/ U568	U167/ U568	U167/ U568	U167/U568	L167
168 208		DIE SET							U168	U168	U168	U168	L168
169		DIE SET							U169	U169	U169	U169	L169
170 306		DIE SET							U170	U170	U170	U170	L170
171		DIE SET							U171	U171	U171	U171	

See Footnotes preceding the table.

PRESENT INSTALLATION TOOL INDEX

DIE GROOVE		DIE INFORMATION		DIELESS TOOLS		INSTALLATION TOOLING USING DIES							
BURNDY	EEI	TYPE	COLOR	MR, MY	444S/644 Series	MD/PATMD Series	OUR840	Y29BH	35 ① Series	750 ① Series	Y45 ②	46 ③ Series	60 Series
193		DIE SET							U193	U193	U193	U193	L193
202		DIE SET							U202	U202	U202	U202	
203		DIE SET							U203	U203	U203	U203	
204		DIE SET							U204	U204	U204	U204	
205 165 287 339		DIE SET				W165	X165		U165/ U205	U165/ U205	U165/ U205	U165/U205	L165
206 166 459		DIE SET				W166			U166/ U459	U166/ U459	U166/ U459	U166/U459	L166
207 167 211 256 568		DIE SET				W167			U167/ U568	U167/ U568	U167/ U568	U167/U568	L167
208 168		DIE SET							U168	U168	U168	U168	L168
209		DIE SET							U209	U209	U209	U209	L209
210		DIE SET							U210	U210	U210	U210	L210
211 167 256 568		DIE SET				W167			U167/ U568	U167/ U568	U167/ U568	U167/U568	L167
236		DIE SET				W236			U236	U236	U236	U236	
237		DIE SET				W237	X237		U237	U237	U237	U237	
238		DIE SET				W238			U238	U238	U238	U238	
239		DIE SET				W239	X239		U239	U239	U239	U239	
240		DIE SET	RED			W240			U240	U240	U240	U240	
241		DIE SET				W241	X241		U241	U241	U241	U241	
242 244	3S/4S	DIE SET				W242			U242	U242	U242	U242	L242
243		DIE SET				W243			U243	U243	U243	U243	L243
244 242	3S/4S	DIE SET				W242			U242	U242	U242	U242	L242
245	9A	DIE SET				W245	X245		U245	U245	U245	U245	L245
246 248	5S	DIE SET				W248			U248	U248	U248	U248	L248
247		DIE SET				W247	X247		U247	U247	U247	U247	L247
248 246	5S	DIE SET				W248			U248	U248	U248	U248	L248
249	11A	DIE SET				W249	X249		U249	U249	U249	U249	L249
250		DIE SET							U250	U250	U250	U250	L250
251	12A	DIE SET	RED			W251			U251	U251	U251	U251	L251
252		DIE SET							U252	U252	U252	U252	L252
253		DIE SET							U253	U253	U253	U253	L253
254		DIE SET									S254	P254	L254
255		DIE SET							U255	U255	U255	U255	L255
256 167 207 211 568		DIE SET				W167			U167/ U567	U167/ U567	U167/ U567	U167/U567	L167
257		DIE SET							U257	U257	U257	U257	L257
259		DIE SET							U259	U259	U259	U259	

See Footnotes preceding the table.

PRESENT INSTALLATION TOOL INDEX

DIE GROOVE		DIE INFORMATION		DIELESS TOOLS		INSTALLATION TOOLING USING DIES								
BURNDY	EEl	TYPE	COLOR	MR, MY	444S/644 Series	MD/PATMD Series	OUR840	Y29BH	35 ① Series	750 ① Series	Y45 ②	46 ③ Series	60 Series	
260		DIE SET											L260	
261 318	15A	DIE SET							U261	U261	U261	U261	L261	
263		DIE SET							U263	U263	U263	U263		
267		DIE SET							U267	U267	U267	U267	L267	
275 164		DIE SET				W164			U164	U164	U164	U164		
276		DIE SET							U276	U276	U276	U276		
285		DIE SET							U285	U285	U285	U285		
287 165 205 339		DIE SET				W165			U165/ U205	U165/ U205	U165/ U205	U165/U205	L165	
292 578		DIE SET									S292	P292	L292	
293 294		DIE SET											L293	
296		DIE SET	TAN	MY293	1 CRIMP		X25ART		U25ART	U25ART	U25ART	U25ART		
		NEST									P27D			
		INDENTOR										P34PR5		
297		DIE SET	OLIVE	MY293	1 CRIMP		X26ART		U26ART	U26ART	U26ART	U26ART		
		NEST										P29D		
		INDENTOR											P34PR5	
298		DIE SET	WHITE	MY293	1 CRIMP		X28ART		U28ART	U28ART	U28ART	U28ART	L28ART	
		NEST											P31D	
		INDENTOR											Y45PR5	
299		DIE SET	BROWN		1 CRIMP				U31ART	U31ART	U31ART	U31ART	L31ART	
		NEST											P35D	
		INDENTOR											P48PR1	
300		DIE SET	PINK		1 CRIMP				U34ART	U34ART	U34ART	U34ART	L34ART	
		NEST											P39D	
		INDENTOR											P48PR1	
301		DIE SET	RED		1 CRIMP						S39ART	P39ART	L39ART	
		NEST											P45D	
		INDENTOR											P48PR1	
302		DIE SET	BROWN		1 CRIMP						S44ART	P44ART	L44ART	
		NEST											No Nest	
		INDENTOR											P48PR1	
303		DIE SET	GRAY		2 CRIMPS				U42ART	U42ART	U42ART	U42ART		
304		DIE SET							U304	U304	U304	U304	L304	
305 341		DIE SET							U305	U305	U305	U305	L305	
306 170		DIE SET							U170	U170	U170	U170	L170	
308		DIE SET							U308	U308	U308	U308		
313		DIE SET							U313	U313	U313	U313	L313	
314 376		DIE SET											L314	

See Footnotes preceding the table.

PRESENT INSTALLATION TOOL INDEX

DIE GROOVE		DIE INFORMATION		DIELESS TOOLS		INSTALLATION TOOLING USING DIES							
BURNDY	E EI	TYPE	COLOR	MR, MY	444S/644 Series	MD/PATMD Series	OUR840	Y29BH	35 ① Series	750 ① Series	Y45 ②	46 ③ Series	60 Series
316		DIE SET							U316	U316	U316	U316	L316
317 426		DIE SET							U317	U317	U317	U317	L317
318 261		DIE SET							U261	U261	U261	U261	L261
319		DIE SET									S319	P319	L319
320		DIE SET									S320	P320	L320
321		DIE SET							U321	U321	U321	U321	L321
322		DIE SET							U322	U322	U322	U322	
324		DIE SET	RED		1 CRIMP				U29ART	U29ART	U29ART	U29ART	L29ART
		NEST										P32D	
		INDENTOR										P34PR5	
326 538		DIE SET						U33RT	U33RT	U33RT	U33RT		
327	14A	DIE SET							U327	U327	U327	U327	L327
328		DIE SET											L328
329		DIE SET							U329	U329	U329	U329	
331		DIE SET							U331	U331	U331	U331	
339 165 205 287		DIE SET					X339		U165/ U205	U165/ U205	U165/ U205	U165/U205	L165
341 305		DIE SET							U305	U305	U305	U305	L305
342		DIE SET									S342	P342	L342
344		DIE SET											L344
345		DIE SET											L345
346 ③		DIE SET	GRAY		1 CRIMP		X6CART		U6CABT	U6CABT	U6CABT	U6CABT	
348		DIE SET	PINK		1 CRIMP		X2CART		U2CABT	U2CABT	U2CABT	U2CABT	
350		DIE SET							U350	U350	U350	U350	L350
352		DIE SET									S352	P352	L352
373		DIE SET							U373	U373	U373	U373	
374		DIE SET	BLUE	MY293			X8CART		U8CABT	U8CABT	U8CABT	U8CABT	
375		DIE SET	GREEN	MY293	1 CRIMP		X4CART		U4CABT	U4CABT	U4CABT	U4CABT	
376 314		DIE SET											L314
400		DIE SET	PINK						U38RT	U38RT	U38RT	U38RT	
403		DIE SET							U403	U403	U403	U403	
419		DIE SET									S419	P419	L419
422		DIE SET											L422
426 317		DIE SET							U317	U317	U317	U317	
459 166		DIE SET							U166/ U459	U166/ U459	U166/ U459	U166/U459	
467		DIE SET	RUBY	MY293	1 CRIMP				X27ART	U27ART	U27ART	U27ART	U27ART
		NEST										P30D	
		INDENTOR										P34PR5	
468		DIE SET							U468	U468	U468	U468	
469		DIE SET									S469	P469	L469

See Footnotes preceding the table.

PRESENT INSTALLATION TOOL INDEX

DIE GROOVE		DIE INFORMATION		DIELESS TOOLS		INSTALLATION TOOLING USING DIES								
BURNDY	E EI	TYPE	COLOR	MR, MY	444S/644 Series	MD/PATMD Series	OUR840	Y29BH	35 ① Series	750 ① Series	Y45 ②	46 ③ Series	60 Series	
470		DIE SET	BLUE		1 CRIMP				U30ART	U30ART	U30ART	U30ART	L30ART	
		NEST											P34D	
		INDENTOR												P48PR1
471		DIE SET	GOLD		MY293 1 CRIMP		X1CART		U1CART	U1CART	U1CART	U1CART		
		NEST												
		INDENTOR												
472		DIE SET	GREEN		1 CRIMP				U32ART	U32ART	U32ART	U32ART	L32ART	
		NEST											P35D	
		INDENTOR												P48PR1
473		DIE SET	BLACK		1 CRIMP				U36ART	U36ART	U36ART	U36ART	L36ART	
		NEST												P44D
		INDENTOR												P48PR1
474		DIE SET	GOLD		1 CRIMP						S40ART	P40ART	L40ART	
		NEST												
		INDENTOR												
478		DIE SET	BLUE										L46ART	
		NEST												
		INDENTOR												
479		DIE SET	RED										L48ART	
490547		DIE SET							U490	U490	U490	U490	L490	
495		DIE SET											L495	
505 163		DIE SET				W163			U163	U163	U163	U163	L163	
511		NEST INDENTOR		MY293										
512		NEST INDENTOR		MY293										
513		NEST INDENTOR		MY293										
514		NEST INDENTOR		MY293										
515		NEST INDENTOR		MY293										
516		NEST INDENTOR		MY293										
517		NEST INDENTOR		MY293										
518		NEST INDENTOR		MY293										
519		NEST INDENTOR		MY293										
520		NEST INDENTOR		MY293										

See Footnotes preceding the table.

PRESENT INSTALLATION TOOL INDEX

DIE GROOVE		DIE INFORMATION		DIELESS TOOLS		INSTALLATION TOOLING USING DIES							
BURNDY	E EI	TYPE	COLOR	MR, MY	444S/644 Series	MD/PATMD Series	OUR840	Y29BH	35 ① Series	750 ① Series	Y45 ②	46 ③ Series	60 Series
538 326		DIE SET							U33RT	U33RT	U33RT	U33RT	
547 490		DIE SET							U490	U490	U490	U490	L490
552		DIE SET							U552	U552	U552	U552	
568 167 207 211 256		DIE SET				W167			U167/ U568	U167/ U568	U167/ U568	U167/U568	
575		DIE SET											L575
576		DIE SET											L576
578 292		DIE SET									S292	P292	L292
579		DIE SET									S579	P579	L579
587		DIE SET											L47ART
607		DIE SET							U607	U607	U607	U607	
608		DIE SET							U608	U608	U608	U608	L608
609		DIE SET							U609	U609	U609	U609	
627		DIE SET											L627
642		DIE SET							U642	U642	U642	U642	L642
643		DIE SET							U643	U643	U643	U643	
647 ④		DIE SET											L45ART
648		DIE SET											L648
654		DIE SET	PURPLE						U654	U654	U654	U654	L654
655	13A	DIE SET							U655	U655	U655	U655	
658		DIE SET							U658	U658	U658	U658	
659		DIE SET				W659			U659	U659	U659	U659	
660		DIE SET				W660	X660		U660	U660	U660	U660	
667		DIE SET											L667
668		DIE SET							U668	U668	U668	U668	
676		DIE SET							U676	U676	U676	U676	
677		DIE SET							U677	U677	U677	U677	L677
678		DIE SET							U678	U678	U678	U678	
679		DIE SET							U679	U679	U679	U679	
684		DIE SET											L684
687		DIE SET				W687	X687						
690	1S	DIE SET				W690			U690	U690	U690	U690	
691	2S	DIE SET				W691			U691	U691	U691	U691	
692	4S	DIE SET				W692			U692	U692	U692	U692	
693	6A	DIE SET				W693			U693	U693	U693	U693	
694	10A	DIE SET				W694			U694	U694	U694	U694	
702		DIE SET				W702							

See Footnotes preceding the table.

PRESENT INSTALLATION TOOL INDEX

DIE GROOVE		DIE INFORMATION		DIELESS TOOLS		INSTALLATION TOOLING USING DIES							
BURNDY	EI	TYPE	COLOR	MR, MY	444S/644 Series	MD/PATMD Series	OUR840	Y29BH	35 ① Series	750 ① Series	Y45 ②	46 ③ Series	60 Series
705		DIE SET							U705	U705	U705	U705	
717 ⑤		DIE SET									S717	P717	L717/ L717W
718 ⑤		DIE SET											L718
719 ⑤		DIE SET									S719	P719	L719/ L719W
720 ⑤		DIE SET									S720	P720	L720/ L720W
721 ⑤		DIE SET											L721
722 ⑤		DIE SET									S722	P722	L722/ L722W
723 ⑤		DIE SET											L723
724 ⑤		DIE SET									S724	P724	L724/ L724W
725 ⑤		DIE SET									S725	P725	L725/ L725W
726 ⑤		DIE SET											L726
727 ⑤		DIE SET											L727/ L727W
728 ⑤		DIE SET											L728/ L728W
729 ⑤		DIE SET											L729/ L729W
735 ⑤		DIE SET											L735/ L735W
740 ⑤		DIE SET											L740
786		DIE SET							U786	U786	U786	U786	
788		DIE SET							U788	U788	U788	U788	
789		DIE SET											L789
936 ⑤		DIE SET	YELLOW		1 CRIMP				U39ART2	U39ART2	U39ART2	U39ART2	L39ART2
997		DIE SET	ORANGE						U997	U997	U997	U997	
998		DIE SET								PU998	S998	P998	
999		DIE SET									S999	P999	
1011		DIE SET								U1011	S1011	P1011	
1012		DIE SET									S1012		
1013		NEST		MY2911					UV8L	UV8L	UV8L	UV8L	
		INDENTOR							Y34PL	Y34PL	Y34PL	Y34PL	
1014		NEST		MY2911					U6CD1	U6CD1	U6CD1	U6CD1	
		INDENTOR							Y34PR	Y34PR	Y34PR	Y34PR	
1015		NEST		MY2911					U4CD1	U4CD1	U4CD1	U4CD1	
		INDENTOR							Y34PR	Y34PR	Y34PR	Y34PR	
1016		NEST		MY2911					U3CD1	U3CD1	U3CD1	U3CD1	
		INDENTOR							Y34PR	Y34PR	Y34PR	Y34PR	

See Footnotes preceding the table.

PRESENT INSTALLATION TOOL INDEX

DIE GROOVE		DIE INFORMATION		DIELESS TOOLS		INSTALLATION TOOLING USING DIES							
BURNDY	E EI	TYPE	COLOR	MR, MY	444S/644 Series	MD/PATMD Series	OUR840	Y29BH	35 ① Series	750 ① Series	Y45 ②	46 ③ Series	60 Series
1017		NEST		MY2911					U2CD1	U2CD1	U2CD1	U2CD1	
		INDENTOR							Y34PR	Y34PR	Y34PR	Y34PR	
1018		NEST		MY2911					U1CD1	U1CD1	U1CD1	U1CD1	
		INDENTOR							Y34PR	Y34PR	Y34PR	Y34PR	
1019		NEST		MY2911					U25D1	U25D1	U25D1	U25D1	
		INDENTOR							Y34PR2	Y34PR2	Y34PR2	Y34PR2	
1020		NEST		MY2911					U26D1	U26D1	U26D1	U26D1	
		INDENTOR							Y34PR2	Y34PR2	Y34PR2	Y34PR2	
1021		NEST		MY2911					U27D1	U27D1	U27D1	U27D1	
		INDENTOR							Y34PR2	Y34PR2	Y34PR2	Y34PR2	
1022		NEST		MY2911					U28D1	U28D1	U28D1	U28D1	
		INDENTOR							Y34PR2	Y34PR2	Y34PR2	Y34PR2	
1023		NEST		MY2911					U29D1	U29D1	U29D1	U29D1	
		INDENTOR							Y34PR2	Y34PR2	Y34PR2	Y34PR2	
1024		NEST							U30D1	U30D1	U30D1	U30D1	
		INDENTOR							Y34PR2	Y34PR2	Y34PR2	Y34PR2	
1025		NEST							U31D1	U31D1	U31D1	U31D1	
		INDENTOR							Y34PR2	Y34PR2	Y34PR2	Y34PR2	
1026		NEST							U32D1	U32D1	U32D1	U32D1	
		INDENTOR							Y34PR2	Y34PR2	Y34PR2	Y34PR2	
1027		NEST							U34D1	U34D1	U34D1	U34D1	
		INDENTOR							Y34PR2	Y34PR2	Y34PR2	Y34PR2	
1028		NEST										P36D	
		INDENTOR										Y48PR1	
1029		NEST										P38D	
		INDENTOR										P48PR1	
1030		NEST										P39D	
		INDENTOR										P48PR1	
1031		NEST										P40D	
		INDENTOR										P48PR1	
1032		NEST										P44D	
		INDENTOR										P48PR1	
1102		DIE SET	WHITE									P1102	
1103		DIE SET	BLUE									P1103	
1104		DIE SET	BROWN							U1104		P1104	
1105		DIE SET								U1105		P1105	
2000		NEST							U27B	U27B	U27B		
		INDENTOR							Y34PR15	Y34PR15	Y34PR15		

See Footnotes preceding the table.

COLOR CODING FOR OVERHEAD CONNECTORS

Color Code	Wire Dia. per Strand			
	Str.	Compact	Sol.	ACSR
Brown	10		8	
Green	8		6	
Blue	5, 6		4	6
Orange	3, 4	#2	2	4
Red	1-19, 2	1/0	1	2
Yellow	1/0	2/0		1/0, 1
Gray	2/0	3/0		2/0
Black	3/0	4/0		3/0
Pink	4/0	266, 300		4/0
Red	250			
White	266			
Blue	300	350		266.8 (26/7, 18/1)
Brown	336			
Green	350, 397, 400			336.4 (26/7, 18/1)
Gray	450			
Pink	500			477 (18/1)
Green	556			
Purple	600			
Yellow				556.5 (24/7, 26/7)
Blue	650			
Red	700			
Yellow	750			
Orange	800			
White	900			
Brown	1000			

NOTE: This chart is only intended as a guide. For specific applications, refer to the catalog page of the connector.

COLOR CODING FOR AL/CU CONNECTORS

Color Code	Str.	Color Code	Str.
Blue	8	Blue	300
Gray	6	Brown	350
Green	4	Green	400
Pink	2	Pink	500
Gold	1	Black	600
Tan	1/0	Yellow	700/750
Olive	2/0	Red	700/750
Ruby	3/0	Brown	1000
White	4/0	Blue	1500
Red	250	Red	2000

NOTE: This chart is only intended as a guide. For specific applications, refer to the catalog page of the connector.

COLOR CODING FOR COPPER LUGS AND SPLICES

Color Code	Code Size		Flex Cable
	Str.	Sol.	
Red	8	6	8
Blue	6		6
Blue	5		
Gray	4		4
White	3	2	
Brown	2		2
Green	1		1
Pink	1/0		1/0
Black	2/0		2/0
Orange	3/0		3/0
Purple	4/0		4/0
Yellow	250		4/0 and 250
White	300		250
Red	350		313.1
Blue	400		373.7
Brown	500		444.4
Green	600		
Pink	700		535.3
Purple			600
Black	750		646
Yellow			777.7
Orange	800		
White	1000		
Yellow			1111
Green	1500		
Brown	2000		

NOTE: This chart is only intended as a guide. For specific applications, refer to the catalog page of the connector.

BURNDY® REGISTERED AND TRADE NAMES

Registered Name	Registered/Trade Name	Catalog Section	Registered/Trade Name	Catalog Section
4-POINT®	4-POINT™	N	MOLE™	A, K
BONDIT®	ALFLUID™	N	MOLIMITER™	K
BURNDY®	BARTAP™	A, E, L	OKLIP™	A, H
BURNDYWeld®	BONDIT®	E	PATRIOT®	N
The CONSTRUCTOR®	BURNDYWeld®	E	PENETROX™	F
ENFORCER®	CABELOK™	H	POLYTAP™	A
GRIDMAX®	CLIPIT™	H	POPPER™	N
HYGROUND®	CRIMPIT™	C, E, H	POSI-PRESS™	N
IMPLO®	The CONSTRUCTOR®	E	POWERLUG™	J
INFINITY DRIVE®	DURIUM™	F	QIKLINK™	A
IN-LINE®	ENFORCER®	N	QIKLITE®	E
PATRIOT®	FASTAP™	H	QIKLUG™	A, E
SERVIT®	FINGRIP™	B	QIKTAP™	B
WEEB®	FLEXITAP™	A	SCRULUG™	A
There is Only One IMPLO®	GRIDLOK™	E	SERVIT POST™	E
	GRIDMAX®	E	SERVIT®	A, H
Connecting Power to Your World®	GROUNDLINK™	E	STIRRUP™	H, J
	GROUNDMAX™	E	STUDBUG™	E
	HYCRAB™	K	SUPER-CLAMP™	E
	HYCRIMP™	H	TAPIT™	H
	HYDENT™	B, C	TRITAP™	A
	HYFLUID™	N	U-BLOK™	A
	HYGRID™	E	UNIGROUND™	E
	HYGROUND®	E	UNIRAP™	G
	HYLINK™	B, C, E	UNISPLICE™	H
	HYLUG™	B, C, E, H	UNITAP™	A
	HYPLUG™	C, H	VARILUG™	L
	HYPRESS™	N	VARITAP™	A
	HYREDUCER™	B, C	VERSILUG™	A
	HYSEALPLUG™	H	VERSIPOLE™	A
	HYSEALUG™	H	VERSITAIL™	E
	HYSPLICE™	C, H	VERSITAP™	A, H
	Hystack™	C	VINYLUG™	B
	HYTAIL™	E	VISEIT™	H
	HYTAP™	C, E	VISI-SHRINK™	D
	HYTEE™	H	WEEB®	E
	HYTOOL™	N	WEJTAP™	J
	INFINITY DRIVE®	N	WIREMIKE™	N
	IN-LINE®	N		
	INSULUG™	B		
	KA-LUG™	A		
	KOMPRESSOR™	N		
	L'IL CRIMP™	N		
	LINEMAN ASSIST™	H		
	LOKTAP™	H		

ALPHA-NUMERIC INDEX BY CATALOG NUMBER

900100.....	E-52	115-2-500.....	E-66, J-45	1PL45.....	A-59
900101.....	E-52	115-250-2S.....	E-69, J-48	1PL46.....	A-59
900102.....	E-52	115-250-3.....	E-69, J-48	1PL48.....	A-59
900103.....	E-52	115-2-750.....	E-66, J-45	1PL60010.....	A-59
900104.....	E-52	115-500.....	E-66, J-45	1PL6002.....	A-58
900105.....	E-52	115-750.....	E-66, J-45	1PL6003.....	A-59
07CD60.....	N-62	119250.....	J-23, J-25	1PL6004.....	A-59
08CD60.....	N-62	119375.....	J-31	1PL6005.....	A-59
09CD60.....	N-62	119375-1.....	J-31	1PL6006.....	A-59
100-ARA-B-250-2.....	E-69, J-48	119793.....	J-23, J-25	1PL6008.....	A-59
100CHENBOX.....	F-7	11CD60.....	N-63	1PL7502.....	A-58
100X200HGSBBOX.....	F-9	120000.....	J-29	1PL7503.....	A-59
102009.....	J-30	120100.....	J-29	1PLD2/02.....	A-60
102009-2.....	J-30	12CD60.....	N-63-64	1PLD2/03.....	A-60
102009-2C.....	J-32	136-2-500.....	E-66, J-45	1PLD2/04.....	A-60
102009-3.....	J-30	136-500.....	E-66, J-45	1PLD2/06.....	A-60
102009-3C.....	J-32	13CD60.....	N-64	1PLD2502.....	A-60
102009-4.....	J-30	140-375.....	E-69, J-48	1PLD2503.....	A-60
102009-4C.....	J-32	145PTAG.....	G-30	1PLD2504.....	A-60
102009C.....	J-32	14CD60.....	N-64	1PLD2506.....	A-60
102010.....	J-30	15.....	E-119	1PLD3502.....	A-60
102010-2.....	J-30	150.....	E-119	1PLD3503.....	A-60
102010-2C.....	J-32	150-1000.....	E-67, J-46	1PLD3504.....	A-60
102010-3.....	J-30	150-2000.....	E-67, J-46	1PLD3506.....	A-60
102010-3C.....	J-32	150-2-500.....	E-67, J-46	1PLD3508.....	A-60
102010C.....	J-32	15CD60.....	N-64	1PLD43.....	A-60
102011.....	J-30	16CD60.....	N-65	1PLD44.....	A-60
102011-2.....	J-30	17CD60.....	N-65	1PLD45.....	A-60
102011-2C.....	J-32	1PBS1/0.....	A-58	1PLD46.....	A-60
102011-3.....	J-30	1PBS2.....	A-58	1PLD48.....	A-60
102011-3C.....	J-32	1PBS250.....	A-58	1PLD6002.....	A-60
102011-4.....	J-30	1PBS350.....	A-58	1PLD6003.....	A-60
102011-4C.....	J-32	1PBS500.....	A-58	1PLD6004.....	A-60
102011C.....	J-32	1PBS750HD.....	A-58	1PLD6005.....	A-60
102012-2C.....	J-32	1PL2/02.....	A-58	1PLD6006.....	A-60
102012-3C.....	J-32	1PL2/03.....	A-59	1PLD6008.....	A-60
102012-4C.....	J-32	1PL2/04.....	A-59	1PLD75010HD.....	A-60
102012C.....	J-32	1PL2/05.....	A-59	1PLD75012HD.....	A-60
102040.....	J-30	1PL2/06.....	A-59	1PLD7502HD.....	A-60
102040C.....	J-32	1PL2/08.....	A-59	1PLD7503HD.....	A-60
103110.....	J-23, J-25	1PL2502.....	A-58	1PLD7504HD.....	A-60
103228.....	J-31	1PL2503.....	A-59	1PLD7505HD.....	A-60
103228-1.....	J-31	1PL2504.....	A-59	1PLD7506HD.....	A-60
103260.....	J-23, J-25	1PL2505.....	A-59	1PLD7508HD.....	A-60
103370.....	J-23, J-25	1PL2506.....	A-59	1PLO2/02.....	A-58
103380.....	J-23, J-25	1PL2508.....	A-59	1PLO2502.....	A-58
103580.....	J-23, J-25	1PL3502.....	A-58	1PLO3502.....	A-58
103580-1.....	J-25	1PL3503.....	A-59	1PLO42.....	A-58
103680.....	J-23, J-25	1PL3504.....	A-59	1PLO6002.....	A-58
103780.....	J-23, J-25	1PL3505.....	A-59	200.....	E-119
103945.....	J-23, J-25	1PL3506.....	A-59	20AH60.....	N-66
10CD60.....	N-62-63	1PL3508.....	A-59	210103.....	J-20, J-24
115.....	E-119	1PL42.....	A-58	210103C.....	J-26
115-1000A.....	E-66, J-45	1PL43.....	A-59	210104.....	J-20, J-24
115-250.....	E-69, J-48	1PL44.....	A-59	210104C.....	J-26

ALPHA-NUMERIC INDEX BY CATALOG NUMBER

210105.....	J-20, J-24	264124-3C.....	J-32	350121.....	J-21, J-24
210105C.....	J-26	264124C.....	J-32	350121C.....	J-26
210106.....	J-20, J-24	264424.....	J-30	350122.....	J-21, J-24
210106C.....	J-26	264424C.....	J-32	350122C.....	J-26
22000.....	E-68, J-47	27AH60.....	N-66	350123.....	J-21, J-24
230107.....	J-20, J-24	290-SEALANTS13.....	D-10	350123C.....	J-26
230107C.....	J-26	290-SEALANTS14.....	D-10	350124.....	J-21, J-24
230108.....	J-20, J-24	290-SEALANTS15.....	D-10	350124C.....	J-26
230108C.....	J-26	290-SEALANTS23.....	D-10	350125.....	J-21, J-24
230109.....	J-20, J-24	290-SEALANTS24.....	D-10	350125C.....	J-26
230109C.....	J-26	290-SEALANTS25.....	D-10	36AH60.....	N-67
230110.....	J-20, J-24	30AH60.....	N-66-67	37-0320-01.....	E-119
230110C.....	J-26	31CHENBOX.....	F-7	37-0320-02.....	E-119
230111.....	J-20, J-24	31CHGSNBOX.....	F-9	37-0320-03.....	E-119
230111C.....	J-26	31FWBOX.....	F-7	38-0101-00.....	E-147
240100.....	J-20, J-24	31NWBOX.....	F-7	38-0101-01.....	E-147
240100C.....	J-26	31SWBOX.....	F-7	38-0135-01.....	E-146
240101.....	J-20, J-24	31X100HEBBOX.....	F-6	38-0200-00.....	E-148
240101C.....	J-26	31X125HEBBOX.....	F-6	38-0201-00.....	E-148
240102.....	J-20, J-24	31X150HEBBOX.....	F-6	38-0202-00.....	E-148
240102C.....	J-26	31X175HEBBOX.....	F-6	38-0203-00.....	E-148
24AH60.....	N-66	31X200HEBBOX.....	F-6	38-0204-00.....	E-148
25.....	E-119	31X250HEBBOX.....	F-6	38-0205-00.....	E-148
250.....	E-119	31X300HEBBOX.....	F-6	38-0207-00.....	E-148
25CHENBOX.....	F-7	31X50HEBBOX.....	F-6	38-0208-00.....	E-148
25FWBOX.....	F-7	31X62HEBBOX.....	F-6	38-0209-00.....	E-148
25FWSBOX.....	F-10	31X75HEBBOX.....	F-6	38-0211-00.....	E-148
25HSSNBOX.....	F-10	32.....	E-119	38-0212-00.....	E-148
25NWBOX.....	F-7	336012.....	J-22, J-24	38-0213-00.....	E-148
25SWBOX.....	F-7	336100.....	J-27	38-0214-00.....	E-148
25SWSSLTBOX.....	F-10	336104.....	J-22, J-24	38-0215-00.....	E-148
25X100HEBBOX.....	F-6	336200.....	J-22, J-24	38-0240-00.....	E-148
25X125HEBBOX.....	F-6	336222.....	J-22, J-24	38-0302-00.....	E-147
25X150HEBBOX.....	F-6	336718.....	J-22, J-24	38-0302-02.....	E-147
25X200HEBBOX.....	F-6	336780.....	J-31	38-0303-00.....	E-147
25X250HEBBOX.....	F-6	336781.....	J-31	38-0304-00.....	E-147
25X300HEBBOX.....	F-6	336866.....	J-22, J-24		E-146, E-147,
25X50HEBBOX.....	F-6	336875.....	J-31	38-0305-00.....	F-4
25X62HEBBOX.....	F-6	336915-1.....	J-30	38-0306-00.....	E-146, E-147
25X75HEBBOX.....	F-6	336915-1C.....	J-32	38-0307-00.....	E-147
264110C.....	J-26	336915-2.....	J-30	38-0308-00.....	E-147
264111.....	J-20, J-24	336915-2C.....	J-32	38-0309-00.....	E-147
264111C.....	J-26	336915-3.....	J-30	38-0309-01.....	E-147
264112.....	J-20, J-24	336915-3C.....	J-32	38-0330-00.....	E-146
264112C.....	J-26	336915-4.....	J-30	38-3662-01.....	E-148
264113.....	J-20, J-24	336915-4C.....	J-32	38-3662-02.....	E-148
264113C.....	J-26	34AH60.....	N-67	38-3662-03.....	E-148
264114.....	J-20, J-24	350117.....	J-21, J-24	38-3662-04.....	E-148
264114C.....	J-26	350117C.....	J-26	38-3662-05.....	E-148
264115.....	J-20, J-24	350118.....	J-21, J-24	38-3662-06.....	E-148
264115C.....	J-26	350118C.....	J-26	38-3922-00.....	E-146, E-147
264124.....	J-30	350119.....	J-21, J-24	38-4129-00.....	E-146
264124-2.....	J-30	350119C.....	J-26	38-4129-05.....	E-146
264124-2C.....	J-32	350120.....	J-21, J-24	38-6330-00.....	E-109
264124-3.....	J-30	350120C.....	J-26	38-6330-01.....	E-109

ALPHA-NUMERIC INDEX BY CATALOG NUMBER

38-6331-00.....	E-109	40-0106-41.....	E-145	50X250HABBOX.....	F-8
38-6333-00.....	E-109	40-0106-75.....	E-144	50X250HEBBOX.....	F-6
38-6334-00.....	E-109	40-0106-76.....	E-145	50X250HSSBBOX.....	F-10
38-6334-01.....	E-109	40-0106-77.....	E-145	50X275HABBOX.....	F-8
38-6335-00.....	E-109	40-0106-78.....	E-145	50X275HEBBOX.....	F-6
38-6501-25.....	E-142	40-0107-32.....	E-145	50X300HABBOX.....	F-8
38-6501-50.....	E-142	40-0319-01.....	E-146	50X300HEBBOX.....	F-6
38-7228-00.....	E-109	40-0319-03.....	E-146	50X300HSSBBOX.....	F-10
38-7230-00.....	E-109	40-3657-00.....	E-144	50X325HABBOX.....	F-8
38-7725-00.....	E-109	40-4431-00.....	E-145	50X325HEBBOX.....	F-6
38-7725-01.....	E-109	40-4431-01.....	E-145	50X350HABBOX.....	F-8
38AH60.....	N-67	40AH60.....	N-67	50X350HEBBOX.....	F-6
38CHENBOX.....	F-7	433206016010.....	N-32	50X375HABBOX.....	F-8
38EZLITIG.....	E-118	44CHENBOX.....	F-7	50X375HEBBOX.....	F-6
38EZLTRU.....	E-118	44FWBOX.....	F-7	50X400HABBOX.....	F-8
38EZLTSK.....	E-118	44NWBOX.....	F-7	50X400HEBBOX.....	F-6
38FWBOX.....	F-7	44SWBOX.....	F-7	50X425HABBOX.....	F-8
38FWSSBOX.....	F-10	44X150HEBBOX.....	F-6	50X450HABBOX.....	F-8
38HGSN009BOX.....	F-9	44X200HEBBOX.....	F-6	50X450HEBBOX.....	F-6
38HGSNBOX.....	F-9	45.....	E-119	50X500HABBOX.....	F-8
38HSSNBOX.....	F-10	477057.....	J-22, J-24	50X500HEBBOX.....	F-6
38NWBOX.....	F-7	477434.....	J-22, J-24	50X550HABBOX.....	F-8
38NWGSBOX.....	F-9	477633.....	J-22, J-24	50X550HEBBOX.....	F-6
38SWBOX.....	F-7	477724.....	J-22, J-24	50X600HEBBOX.....	F-6
38SWSSMDBOX.....	F-10	477853.....	J-22, J-24	50X75HEBBOX.....	F-6
38X100HEBBOX.....	F-6	477962.....	J-22, J-24	556294.....	J-22, J-24
38X125HEBBOX.....	F-6	500.....	E-119	556294-1.....	J-22, J-24
38X125HGSBBOX.....	F-9	50CHENBOX.....	F-7	556504.....	J-22, J-24
38X125HSSBBOX.....	F-10	50FWABOX.....	F-8	556580.....	J-31
38X150HEBBOX.....	F-6	50FWBOX.....	F-7	556581.....	J-31
38X175HEBBOX.....	F-6	50FWSSBOX.....	F-10	556595.....	J-31
38X200HEBBOX.....	F-6	50HANBOX.....	F-8	556638.....	J-22, J-24
38X225HEBBOX.....	F-6	50HGSNBOX.....	F-9	556783.....	J-22, J-24
38X225HGSBBOX.....	F-9	50HSSNBOX.....	F-10	556892.....	J-22, J-24
38X225HSSBBOX.....	F-10	50NWBOX.....	F-7	556956.....	J-22, J-24
38X250HEBBOX.....	F-6	50NWGSBOX.....	F-9	6002248.....	J-35
38X250HSSBBOX.....	F-10	50SWALBOX.....	F-8	62CHENBOX.....	F-7
38X275HEBBOX.....	F-6	50SWBOX.....	F-7	62FWABOX.....	F-8
38X275HGSBBOX.....	F-9	50SWSSMDBOX.....	F-10	62FWBOX.....	F-7
38X275HSSBBOX.....	F-10	50X100HEBBOX.....	F-6	62FWSSBOX.....	F-10
38X300HEBBOX.....	F-6	50X100HGSBBOX.....	F-9	62HANBOX.....	F-8
38X325HEBBOX.....	F-6	50X106BWSSBOX.....	F-11	62HGSNBOX.....	F-9
38X350HEBBOX.....	F-6	50X106FWGSBOX.....	F-9	62HSSNBOX.....	F-10
38X400HEBBOX.....	F-6	50X125HEBBOX.....	F-6	62NWBOX.....	F-7
38X450HEBBOX.....	F-6	50X150HABBOX.....	F-8	62NWGSBOX.....	F-9
38X500HEBBOX.....	F-6	50X150HEBBOX.....	F-6	62SWALBOX.....	F-8
38X50HEBBOX.....	F-6	50X150HGSBBOX.....	F-9	62SWBOX.....	F-7
38X62HEBBOX.....	F-6	50X175HABBOX.....	F-8	62SWSSMDBOX.....	F-10
38X75BWSSBOX.....	F-11	50X175HEBBOX.....	F-6	62X100HEBBOX.....	F-6
38X75HEBBOX.....	F-6	50X200HABBOX.....	F-8	62X100HGSBBOX.....	F-9
38X81FWGSBOX.....	F-9	50X200HEBBOX.....	F-6	62X125HEBBOX.....	F-6
38X88HEBBOX.....	F-6	50X200HGSBBOX.....	F-9	62X131FWGSBOX.....	F-9
40-0106-27.....	E-145	50X200HSSBBOX.....	F-10	62X150HEBBOX.....	F-6
40-0106-32.....	E-145	50X225HABBOX.....	F-8	62X175HABBOX.....	F-8
40-0106-37.....	E-145	50X225HEBBOX.....	F-6	62X175HEBBOX.....	F-6

ALPHA-NUMERIC INDEX BY CATALOG NUMBER

62X175HGSBBOX.....	F-9	75X300HSSBBOX.....	F-10	ACC-ECTA611.....	E-154, G-29
62X200HABBOX.....	F-8	75X500HGSBBOX.....	F-9	ACC-ECTA614.....	E-154, G-29
62X200HEBBOX.....	F-6	75X600HGSBBOX.....	F-9	ACC-ECTA68.....	E-154, G-29
62X225HABBOX.....	F-8	76AH60.....	N-66	ACC-ECTB1211.....	E-154, G-29
62X225HEBBOX.....	F-6	795050.....	J-23, J-25	ACC-ECTB1214.....	E-154, G-29
62X250HABBOX.....	F-8	795218.....	J-23, J-25	ACC-ECTB128.....	E-154, G-29
62X250HEBBOX.....	F-6	795360.....	J-23, J-25	ACC-ECTB611.....	E-154, G-29
62X275HEBBOX.....	F-6	795405.....	J-31	ACC-ECTB614.....	E-154, G-29
62X300HABBOX.....	F-8	795454.....	J-23, J-25	ACC-ECTB68.....	E-154, G-29
62X300HEBBOX.....	F-6	795500.....	J-31	ACC-F1-270.....	E-152, G-28
62X300HSSBBOX.....	F-10	795501.....	J-31	ACC-F2-90.....	E-152, G-28
62X325HEBBOX.....	F-6	795594.....	J-23, J-25	ACC-F490.....	E-152, G-28
62X350HABBOX.....	F-8	795730.....	J-23, J-25	ACC-F4-90-1.....	E-152, G-28
62X350HEBBOX.....	F-6	795920.....	J-23, J-25	ACC-F4F.....	E-152, G-28
62X400HABBOX.....	F-8	801450.....	J-33	ACC-F90-1.....	E-152, G-28
62X400HEBBOX.....	F-6	801450S.....	J-33	ACC-FBC.....	E-153, G-25
62X450HABBOX.....	F-8	802525.....	J-33	ACC-FF180.....	E-152, G-28
62X450HEBBOX.....	F-6	802525T.....	J-33	ACC-FPV.....	E-151, G-27
62X500HABBOX.....	F-8	802526.....	J-33	ACC-FPV180.....	E-152, G-28
62X500HEBBOX.....	F-6	802526T.....	J-33	ACC-FPV90.....	E-152, G-28
62X550HABBOX.....	F-8		N-18, N-26,	ACC-PV.....	E-151, G-27
62X600HABBOX.....	F-8	81KLRGGUIDEKIT.....	N-36	ACC-R2.....	E-152, G-28
62X600HEBBOX.....	F-6		N-18, N-26,	ACC-R4.....	E-152, G-28
636551.....	J-31	81KSMGLGUIDEKIT.....	N-36	ACC-RBC15.....	E-152, G-28
636556.....	J-31	85-1000.....	E-66, J-45	AFLUIDQT.....	N-101
636556-1.....	J-31	85-2-500.....	E-66, J-45	AGSKIT2.....	A-37
640101.....	J-20, J-24	90.....	E-119	AGSKIT250.....	A-37
65.....	E-119	900100.....	J-43	ALFLUIDGAL.....	N-101
723003.....	J-34	900101.....	J-43	AMS0.....	A-35
723003-1.....	J-34	900102.....	J-43	AMS1000.....	A-35
723004.....	J-34	900103.....	J-43	AMS2.....	A-35
723004-1.....	J-34	900104.....	J-43	AMS250.....	A-35
723005.....	J-34	900105.....	J-43	AMS350.....	A-35
723005-1.....	J-34	900200.....	E-53, J-44	AMS4/0.....	A-35
723006.....	J-34	900201.....	E-53, J-44	AMS500.....	A-35
723006-1.....	J-34	900202.....	E-53, J-44	AMS750.....	A-35
723007.....	J-34	900203.....	E-53, J-44	ASA1000U.....	C-156
723007-1.....	J-34	90-1000.....	E-66, J-45	ASA250U.....	C-156
723008.....	J-34	90-2-500.....	E-66, J-45	ASA800U.....	C-156
723008-1.....	J-34	90SPB1424NN.....	E-111	AYP1.....	C-229
723009.....	J-34	90SPB1424NNH.....	E-111	AYP1/0.....	C-229
723009-1.....	J-34	90SPB1446NN.....	E-111	AYP2.....	C-229
723210.....	J-34	90SPB1446NNH.....	E-111	AYP250.....	C-229
723210-1.....	J-34	954030.....	J-23, J-25	AYP350.....	C-229
750336.....	E-68, J-47	954175.....	J-23, J-25	AYP4.....	C-229
75AH60.....	N-66	954320.....	J-23, J-25	AYP500.....	C-229
75CHENBOX.....	F-7	954390.....	J-23, J-25	AYP6.....	C-229
75FWBOX.....	F-7	954420.....	J-23, J-25	AYP750.....	C-229
75HGSNBBOX.....	F-9	954484.....	J-23, J-25	AYP900.....	C-229
75HSSNBBOX.....	F-10	954660.....	J-23, J-25	AYPO1000.....	C-229
75NWBOX.....	F-7	954870.....	J-23, J-25	AYPO2/0.....	C-229
75NWGSBOX.....	F-9	ACC.....	E-151, G-27	AYPO250.....	C-229
75SWBOX.....	F-7	ACC-ECTA1211.....	E-154, G-29	AYPO3/0.....	C-229
75X125HGSBBOX.....	F-9	ACC-ECTA1214.....	E-154, G-29	AYPO300.....	C-229
75X200HGSBBOX.....	F-9	ACC-ECTA128.....	E-154, G-29	AYPO350.....	C-229

ALPHA-NUMERIC INDEX BY CATALOG NUMBER

AYPO4/0.....	C-229	B3D12.....	E-84	BA14EF10M.....	B-31
AYPO400.....	C-229	B3D12N.....	E-84	BA14EF2.....	B-31
AYPO500.....	C-229	B3E12.....	E-84	BA14EF6.....	B-31
AYPO600.....	C-229	B3E12N.....	E-84	BA14EF8.....	B-31
AYPO750.....	C-229	B3F12.....	E-84	BA14EF8M.....	B-31
AYPO900.....	C-229	B3F12N.....	E-84	BA14EL10.....	B-36
B-106.....	E-144	B3G12.....	E-84	BA14EL10M.....	B-36
B-107.....	E-144	B3G12N.....	E-84	BA14EL6.....	B-36
B1CD.....	N-38	B4CD.....	N-38	BA14EL6M.....	B-36
B22F184N.....	E-91	B4D12.....	E-84	BA14EL8.....	B-36
B22F244N.....	E-91	B4D12N.....	E-84	BA14EL8M.....	B-36
B22F364N.....	E-91	B4E12.....	E-84	BA14EZ10.....	B-45
B22G184N.....	E-91	B4E12N.....	E-84	BA14EZ2.....	B-45
B22G244N.....	E-91	B4F12.....	E-84	BA14EZ6.....	B-45
B22G364N.....	E-91	B4F12N.....	E-84	BA14EZ8.....	B-45
B23F184N.....	E-91	B4G12.....	E-84	BA16E10.....	B-8
B23F244N.....	E-91	BA10E10.....	B-8	BA16E10M.....	B-8
B23F364N.....	E-91	BA10E10M.....	B-8	BA16E14.....	B-8
B23G184N.....	E-91	BA10E14.....	B-8	BA16E14M.....	B-8
B23G244N.....	E-91	BA10E14M.....	B-8	BA16E38.....	B-8
B23G364N.....	E-91	BA10E38.....	B-8	BA16E38M.....	B-8
B24F184N.....	E-91	BA10E38M.....	B-8	BA16E4.....	B-8
B24F244N.....	E-91	BA10E516.....	B-8	BA16E4M.....	B-8
B24F364N.....	E-91	BA10E6.....	B-8	BA16E6.....	B-8
B24G184N.....	E-91	BA10E6M.....	B-8	BA16E6M.....	B-8
B24G244N.....	E-91	BA10E8.....	B-8	BA16E8.....	B-8
B24G364N.....	E-91	BA10E8M.....	B-8	BA16E8M.....	B-8
B25D.....	N-38	BA10EF10.....	B-31	BA16EF10.....	B-31
B26D.....	N-38	BA10EF10M.....	B-31	BA16EF10M.....	B-31
B27D.....	N-38	BA10EF6.....	B-31	BA16EF2.....	B-31
B28D.....	N-38	BA10EF6M.....	B-31	BA16EF2M.....	B-31
B29D.....	N-38	BA10EF8.....	B-31	BA16EF6.....	B-31
B2CD.....	N-38	BA10EF8M.....	B-31	BA16EF6M.....	B-31
B2D12.....	E-84	BA10EL10.....	B-36	BA16EF8.....	B-31
B2D12N.....	E-84	BA10EL10M.....	B-36	BA16EF8M.....	B-31
B2E12.....	E-84	BA10EL6.....	B-36	BA16EL10.....	B-36
B2E12N.....	E-84	BA10EL6M.....	B-36	BA16EL10M.....	B-36
B2F12.....	E-84	BA10EL8.....	B-36	BA16EL6.....	B-36
B2F12N.....	E-84	BA10EL8M.....	B-36	BA16EL6M.....	B-36
B2G12N.....	E-84	BA10EZ10.....	B-45	BA16EL8.....	B-36
B30D.....	N-38	BA10EZ8.....	B-45	BA16EL8M.....	B-36
B31D.....	N-38	BA14E10.....	B-8	BA16EZ10.....	B-45
B32D.....	N-38	BA14E10M.....	B-8	BA16EZ2.....	B-45
B32F184N.....	E-92	BA14E14.....	B-8	BA16EZ6.....	B-45
B32F244N.....	E-92	BA14E14M.....	B-8	BA16EZ8.....	B-45
B32F364N.....	E-92	BA14E38.....	B-8	BAGCNVS5X9X24.....	N-85
B32G184N.....	E-92	BA14E4.....	B-8	BAT18V5AHLI.....	N-5
B32G244N.....	E-92	BA14E4M.....	B-8	BAT18VLI.....	N-5
B32G364N.....	E-92	BA14E516.....	B-8	BB019ML12T14TN.....	E-85
B33F184N.....	E-92	BA14E516M.....	B-8	BB019ML18T14TN.....	E-85
B33F244N.....	E-92	BA14E6.....	B-8	BB019ML24T14TN.....	E-85
B33F364N.....	E-92	BA14E6M.....	B-8	BB019ML6T14TN.....	E-85
B33G184N.....	E-92	BA14E8.....	B-8	BB019ML9T14TN.....	E-85
B33G244N.....	E-92	BA14E8M.....	B-8	BB024L.....	E-80
B33G364N.....	E-92	BA14EF10.....	B-31	BB024L12LT14.....	E-87

ALPHA-NUMERIC INDEX BY CATALOG NUMBER

BB024L12LT14B.....	E-88	BB059ML18T38TN.....	E-86	BCFGK2X36.....	D-11
BB024L18LT14.....	E-87	BB059ML24T38TN.....	E-86	BCFGK3X36.....	D-11
BB024L18LT14B.....	E-88	BB059ML6T38TN.....	E-86	BCPK0102.....	D-11
BB024L24LT14.....	E-87	BB059ML9T38TN.....	E-86	BCPK0306.....	D-11
BB024L24LT14B.....	E-88	BB067L.....	E-80	BCR02302.....	E-50
BB024L6T14.....	E-82	BB067L12T38.....	E-93	BCR03302.....	E-50
BB024L8LT14.....	E-87	BB067L6T14.....	E-82	BCR04302.....	E-50
BB024L9T14.....	E-82	BB067L9T14.....	E-82	BCR05302.....	E-50
BB024SSL12LT14.....	E-89	BB069ML12T38TN.....	E-86	BCR06302.....	E-50
BB024SSL12LT38.....	E-89	BB069ML18T38TN.....	E-86	BCR07302.....	E-50
BB024SSL12LT516.....	E-89	BB069ML24T38TN.....	E-86	BCR10302.....	E-50
BB024SSL6LT14.....	E-89	BB069ML6T38TN.....	E-86	BD12.....	E-83
BB024SSL6LT38.....	E-89	BB069ML9T38TN.....	E-86	BD12N.....	E-83
BB024SSL6LT516.....	E-89	BB077L.....	E-80	BD12N2U.....	E-90
BB024SSL6T14.....	E-89	BB099ML12T12TN.....	E-86	BD12NB.....	E-88
BB024SSL9LT14.....	E-89	BB099ML12T38TN.....	E-86	BD12T38.....	E-93
BB024SSL9LT38.....	E-89	BB099ML18T12TN.....	E-86	BD18.....	E-83
BB024SSL9LT516.....	E-89	BB099ML18T38TN.....	E-86	BD18N.....	E-83
BB031ML12T14TN.....	E-85	BB099ML24T12TN.....	E-86	BD18N2U.....	E-90
BB031ML12T38TN.....	E-85	BB099ML24T38TN.....	E-86	BD18NB.....	E-88
BB031ML18T14TN.....	E-85	BB099ML6T38TN.....	E-86	BD24.....	E-83
BB031ML18T38TN.....	E-85	BB099ML9T12TN.....	E-86	BD24N.....	E-83
BB031ML24T14TN.....	E-85	BB099ML9T38TN.....	E-86	BD24N2U.....	E-90
BB031ML24T38TN.....	E-85	BB139ML12T12TN.....	E-86	BD24NB.....	E-88
BB031ML6T14TN.....	E-85	BB139ML12T38TN.....	E-86	BD36N2U.....	E-90
BB031ML6T38TN.....	E-85	BB139ML18T12TN.....	E-86	BD6T14.....	E-82
BB031ML9T14TN.....	E-85	BB139ML18T38TN.....	E-86	BD9T14.....	E-82
BB031ML9T38TN.....	E-85	BB139ML24T12TN.....	E-86	BDBLCS10LA1DW.....	A-67
BB036L12T14.....	E-82	BB139ML24T38TN.....	E-86	BDBLCS10LA2DW.....	A-67
BB036L18T14.....	E-82	BB154L.....	E-80	BDBLCS10LA3DW.....	A-67
BB036L9T14.....	E-82	BB197ML12T12TN.....	E-86	BDBLCS10LK1DW.....	A-67
BB048L.....	E-80	BB197ML12T38TN.....	E-86	BDBLCS10LK2DW.....	A-67
BB048L12LT12.....	E-87	BB197ML18T12TN.....	E-86	BDBLCS10LK3DW.....	A-67
BB048L12LT14.....	E-87	BB197ML18T38TN.....	E-86	BDBLCS10LR1DW.....	A-67
BB048L12LT38.....	E-87	BB197ML24T12TN.....	E-86	BDBLCS10LR2DW.....	A-67
BB048L12T38.....	E-93	BB197ML24T38TN.....	E-86	BDBLCS10LR3DW.....	A-67
BB048L18LT12.....	E-87	BB226L.....	E-80	BDBLCS10LV1DW.....	A-67
BB048L18LT14.....	E-87	BB300L.....	E-80	BDBLCS10LV2DW.....	A-67
BB048L18LT38.....	E-87	BBB14210A.....	E-98	BDBLCS10LV3DW.....	A-67
BB048L24LT12.....	E-87	BBB14224B.....	E-98	BDBLCS13LA1DW.....	A-67
BB048L24LT14.....	E-87	BBB14410C.....	E-98	BDBLCS13LA2DW.....	A-67
BB048L24LT38.....	E-87	BBB14410D.....	E-98	BDBLCS13LA3DW.....	A-67
BB048L6T14.....	E-82	BBB14412E.....	E-98	BDBLCS13LK1DW.....	A-67
BB048L9T14.....	E-82	BBB14412F.....	E-98	BDBLCS13LK2DW.....	A-67
BB049ML12T14TN.....	E-85	BBB14416G.....	E-98	BDBLCS13LK3DW.....	A-67
BB049ML12T38TN.....	E-86	BBB14416H.....	E-98	BDBLCS13LR1DW.....	A-67
BB049ML18T14TN.....	E-85	BBB14420J.....	E-98	BDBLCS13LR2DW.....	A-67
BB049ML18T38TN.....	E-86	BBB412UD.....	E-98	BDBLCS13LR3DW.....	A-67
BB049ML24T14TN.....	E-85	BBB424UD.....	E-98	BDBLCS13LV1DW.....	A-67
BB049ML24T38TN.....	E-86	BBBHR19.....	E-98	BDBLCS13LV2DW.....	A-67
BB049ML6T14TN.....	E-85	BBBVR36.....	E-98	BDBLCS13LV3DW.....	A-67
BB049ML6T38TN.....	E-86	BC25.....	H-73	BDBLCS3A1.....	A-62
BB049ML9T14TN.....	E-85	BC28.....	H-73	BDBLCS3A1FS.....	A-62
BB049ML9T38TN.....	E-86	BC2C.....	H-73	BDBLCS3A1FSKIT.....	A-62
BB059ML12T38TN.....	E-86	BCFGK1X36.....	D-11	BDBLCS3A2.....	A-62

ALPHA-NUMERIC INDEX BY CATALOG NUMBER

BDBLCS3A2FS.....	A-62	BDBLCS6K1	A-63	BDBMCS2N2FS	A-62
BDBLCS3A3	A-62	BDBLCS6K1FS	A-63	BDBMCS2N3	A-62
BDBLCS3A3FS.....	A-62	BDBLCS6K1FSKIT	A-63	BDBMCS2N3FS	A-62
BDBLCS3AA	A-62	BDBLCS6K2	A-63	BDBMCS2NA.....	A-62
BDBLCS3K1	A-62	BDBLCS6K2FS	A-63	BDBMCS3S3S1.....	A-65
BDBLCS3K1FS	A-62	BDBLCS6K3	A-63	BDBMCS3SF1	A-65
BDBLCS3K1FSKIT	A-62	BDBLCS6K3FS	A-63	BDBMCS3SM1	A-65
BDBLCS3K2	A-62	BDBLCS6KA	A-63	BDBMCS3U1.....	A-62
BDBLCS3K2FS.....	A-62	BDBLCS6R1	A-63	BDBMCS3U1FS.....	A-62
BDBLCS3K3	A-62	BDBLCS6R1FS	A-63	BDBMCS3U1FSKIT.....	A-62
BDBLCS3K3FS.....	A-62	BDBLCS6R1FSKIT.....	A-63	BDBMCS3U2	A-62
BDBLCS3KA	A-62	BDBLCS6R2	A-63	BDBMCS3U2FS	A-62
BDBLCS4K1	A-63	BDBLCS6R2FS	A-63	BDBMCS3U3	A-62
BDBLCS4K1FS	A-63	BDBLCS6R3	A-63	BDBMCS3U3FS	A-62
BDBLCS4K1FSKIT	A-63	BDBLCS6R3FS	A-63	BDBMCS3UA	A-62
BDBLCS4K2	A-63	BDBLCS6RA	A-63	BDBMCS5F1	A-62
BDBLCS4K2FS.....	A-63	BDBLCS6V1	A-63	BDBMCS5F1FS	A-62
BDBLCS4K3	A-63	BDBLCS6V1FS	A-63	BDBMCS5F1FSKIT	A-62
BDBLCS4K3FS.....	A-63	BDBLCS6V1FSKIT	A-63	BDBMCS5F2	A-62
BDBLCS4KA	A-63	BDBLCS6V2	A-63	BDBMCS5F2FS	A-62
BDBLCS4T1	A-63	BDBLCS6V2FS	A-63	BDBMCS5F3	A-62
BDBLCS4T1FS.....	A-63	BDBLCS6V3	A-63	BDBMCS5F3FS	A-62
BDBLCS4T1FSKIT	A-63	BDBLCS6V3FS	A-63	BDBMCS5FA	A-62
BDBLCS4T2	A-63	BDBLCS6VA	A-63	BDBMCS5M1	A-62
BDBLCS4T2FS.....	A-63	BDBLCS7A1DW.....	A-65	BDBMCS5M1FS	A-62
BDBLCS4T3	A-63	BDBLCS7K1DW.....	A-65	BDBMCS5M1FSKIT	A-62
BDBLCS4T3FS	A-63	BDBLCS7R1DW.....	A-65	BDBMCS5M2	A-62
BDBLCS4TA.....	A-63	BDBLCS7X1DW.....	A-65	BDBMCS5M2FS	A-62
BDBLCS5K1	A-63	BDBLCS8Y1	A-63	BDBMCS5M3	A-62
BDBLCS5K1FS	A-63	BDBLCS8Y1FS	A-63	BDBMCS5M3FS	A-62
BDBLCS5K1FSKIT	A-63	BDBLCS8Y2	A-63	BDBMCS5MA	A-62
BDBLCS5K2	A-63	BDBLCS8Y2FS.....	A-63	BDBSCS1C1.....	A-61
BDBLCS5K2FS	A-63	BDBLCS8Y3	A-63	BDBSCS1C1FS.....	A-61
BDBLCS5K3	A-63	BDBLCS8Y3FS.....	A-63	BDBSCS1C1FSKIT.....	A-61
BDBLCS5K3FS	A-63	BDBLCS8YA	A-63	BDBSCS1C2	A-61
BDBLCS5KA	A-63	BDBMCS1F1	A-62	BDBSCS1C2FS.....	A-61
BDBLCS5S5S1.....	A-65	BDBMCS1F1FS.....	A-62	BDBSCS1C3	A-61
BDBLCS5SA1.....	A-65	BDBMCS1F1FSKIT.....	A-62	BDBSCS1C3FS	A-61
BDBLCS5SK1.....	A-65	BDBMCS1F2	A-62	BDBSCS1CA	A-61
BDBLCS5W1	A-63	BDBMCS1F2FS.....	A-62	BDBSCS1P1.....	A-62
BDBLCS5W1FS	A-63	BDBMCS1F3	A-62	BDBSCS1P1FS.....	A-62
BDBLCS5W1FSKIT	A-63	BDBMCS1F3FS	A-62	BDBSCS1P1FSKIT.....	A-62
BDBLCS5W2	A-63	BDBMCS1FA	A-62	BDBSCS1P2.....	A-62
BDBLCS5W2FS	A-63	BDBMCS2F1	A-62	BDBSCS1P2FS.....	A-62
BDBLCS5W3	A-63	BDBMCS2F1FS	A-62	BDBSCS1P3.....	A-62
BDBLCS5W3FS	A-63	BDBMCS2F1FSKIT	A-62	BDBSCS1P3FS.....	A-62
BDBLCS5WA	A-63	BDBMCS2F2	A-62	BDBSCS1PA	A-62
BDBLCS6A1	A-63	BDBMCS2F2FS.....	A-62	BDBSCS1S1S1	A-65
BDBLCS6A1FS	A-63	BDBMCS2F3	A-62	BDT1	E-60
BDBLCS6A1FSKIT	A-63	BDBMCS2F3FS.....	A-62	BDTIBB	E-61
BDBLCS6A2	A-63	BDBMCS2FA.....	A-62	BE12	E-83
BDBLCS6A2FS	A-63	BDBMCS2N1.....	A-62	BE12N.....	E-83
BDBLCS6A3	A-63	BDBMCS2N1FS.....	A-62	BE12N2U.....	E-90
BDBLCS6A3FS	A-63	BDBMCS2N1FSKIT.....	A-62	BE12T58.....	E-82
BDBLCS6AA	A-63	BDBMCS2N2	A-62	BE12T716.....	E-82, E-93

ALPHA-NUMERIC INDEX BY CATALOG NUMBER

BE18.....	E-83	BGBL250.....	A-23	BIBD2504MT.....	A-48
BE18N.....	E-83	BGBL4.....	A-23	BIBD2505.....	A-45
BE18N2U.....	E-90	BGBL4SS.....	A-23	BIBD2505FX.....	A-54
BE18T58.....	E-82	BGRKTD30DN.....	E-97	BIBD2506.....	A-45
BE18T716.....	E-82	BGRKTD60C46.....	E-97	BIBD2506FX.....	A-54
BE24.....	E-83	BGRKTD9D.....	E-97	BIBD2506MT.....	A-48
BE24N.....	E-83	BGRKTHC.....	E-95	BIBD2508.....	A-45
BE24N2U.....	E-90	BGRKTKA9KA5.....	E-96	BIBD2508FX.....	A-54
BE24T58.....	E-82	BGRKTVTC.....	E-95	BIBD2508FXMT.....	A-57
BE36N2U.....	E-90	BGRKTWB5.....	E-96	BIBD2508MT.....	A-48
BE6T716.....	E-82	BHSG1100.....	D-19	BIBD35010.....	A-46
BF12.....	E-83	BIBD2/010.....	A-45	BIBD35010FX.....	A-55
BF12N.....	E-83	BIBD2/010FX.....	A-54	BIBD35010FXMT.....	A-57
BF12N2U.....	E-90	BIBD2/010FXMT.....	A-57	BIBD35010MT.....	A-48
BF12T716.....	E-82, E-93	BIBD2/010MT.....	A-48	BIBD35012.....	A-46
BF18.....	E-83	BIBD2/012.....	A-45	BIBD35012FX.....	A-55
BF18N.....	E-83	BIBD2/012FX.....	A-54	BIBD35012FXMT.....	A-57
BF18N2U.....	E-90	BIBD2/012FXMT.....	A-57	BIBD35012MT.....	A-48
BF18T716.....	E-82	BIBD2/012MT.....	A-48	BIBD35014.....	A-46
BF24.....	E-83	BIBD2/014.....	A-45	BIBD3502.....	A-46
BF24N.....	E-83	BIBD2/014FX.....	A-54	BIBD3502FX.....	A-55
BF24N2U.....	E-90	BIBD2/02.....	A-45	BIBD3503.....	A-46
BF36N2U.....	E-90	BIBD2/02FX.....	A-54	BIBD3503FX.....	A-55
BF6T716.....	E-82	BIBD2/03.....	A-45	BIBD3504.....	A-46
BFB1020T12.....	E-28	BIBD2/03FX.....	A-54	BIBD3504FX.....	A-55
BFB1024T12.....	E-28	BIBD2/04.....	A-45	BIBD3504FXMT.....	A-57
BFB1032T12.....	E-28	BIBD2/04FX.....	A-54	BIBD3504MT.....	A-48
BFB10402TH38E26.....	E-28	BIBD2/04FXMT.....	A-57	BIBD3505.....	A-46
BFB10402TH38E27.....	E-28	BIBD2/04MT.....	A-48	BIBD3505FX.....	A-55
BFB1040T58.....	E-28	BIBD2/05.....	A-45	BIBD3506.....	A-46
BFB10502TH38E26.....	E-28	BIBD2/05FX.....	A-54	BIBD3506FX.....	A-55
BFB10502TH38E27.....	E-28	BIBD2/06.....	A-45	BIBD3506FXMT.....	A-57
BFB1050T58.....	E-28	BIBD2/06FX.....	A-54	BIBD3506MT.....	A-48
BFB620T12.....	E-28	BIBD2/06MT.....	A-48	BIBD3508.....	A-46
BFB624T12.....	E-28	BIBD2/08.....	A-45	BIBD3508FX.....	A-55
BFB632T12.....	E-28	BIBD2/08FX.....	A-54	BIBD3508FXMT.....	A-57
BFB6402TH38E26.....	E-28	BIBD2/08FXMT.....	A-57	BIBD3508MT.....	A-48
BFB640T58.....	E-28	BIBD2/08MT.....	A-48	BIBD42.....	A-45
BFB6502TH38E26.....	E-28	BIBD25010.....	A-45	BIBD42FX.....	A-54
BFB650T58.....	E-28	BIBD25010FX.....	A-54	BIBD43.....	A-45
BG12.....	E-83	BIBD25010FXMT.....	A-57	BIBD43FX.....	A-54
BG12N.....	E-83	BIBD25010MT.....	A-48	BIBD44.....	A-45
BG12N2U.....	E-90	BIBD25012.....	A-45	BIBD44FX.....	A-54
BG12T12.....	E-82, E-93	BIBD25012FX.....	A-54	BIBD45.....	A-45
BG12T716.....	E-82	BIBD25012FXMT.....	A-57	BIBD45FX.....	A-54
BG18.....	E-83	BIBD25012MT.....	A-48	BIBD46.....	A-45
BG18N.....	E-83	BIBD25014.....	A-45	BIBD46FX.....	A-54
BG18N2U.....	E-90	BIBD25014FX.....	A-54	BIBD48.....	A-45
BG24.....	E-83	BIBD2502.....	A-45	BIBD48FX.....	A-54
BG24N.....	E-83	BIBD2502FX.....	A-54	BIBD60010.....	A-46
BG24N2U.....	E-90	BIBD2503.....	A-45	BIBD60010FX.....	A-55
BG36N2U.....	E-90	BIBD2503FX.....	A-54	BIBD60010FXMT.....	A-57
BG6T716.....	E-82	BIBD2504.....	A-45	BIBD60010MT.....	A-48
BG8T716.....	E-82	BIBD2504FX.....	A-54	BIBD60012.....	A-46
BGBL1/0.....	A-23	BIBD2504FXMT.....	A-57	BIBD60012FX.....	A-55

ALPHA-NUMERIC INDEX BY CATALOG NUMBER

BIBD60012FXMT.....	A-57	BIBS2/05FX.....	A-52	BIBS3505DB.....	A-40
BIBD60012MT.....	A-48	BIBS2/06.....	A-43	BIBS3505FX.....	A-52
BIBD60014.....	A-46	BIBS2/06FX.....	A-52	BIBS3506.....	A-43
BIBD60014FX.....	A-55	BIBS2/06FXMT.....	A-56	BIBS3506DB.....	A-40
BIBD6002.....	A-46	BIBS2/06MT.....	A-47	BIBS3506FX.....	A-52
BIBD6002FX.....	A-55	BIBS2/08.....	A-43	BIBS3506FXMT.....	A-56
BIBD6003.....	A-46	BIBS2/08FX.....	A-52	BIBS3506MT.....	A-47
BIBD6003FX.....	A-55	BIBS2/08FXMT.....	A-56	BIBS3508.....	A-43
BIBD6004.....	A-46	BIBS2/08MT.....	A-47	BIBS3508FX.....	A-52
BIBD6004FX.....	A-55	BIBS25010.....	A-43	BIBS3508FXMT.....	A-56
BIBD6004FXMT.....	A-57	BIBS25010FX.....	A-52	BIBS3508MT.....	A-47
BIBD6004MT.....	A-48	BIBS25010FXMT.....	A-56	BIBS43.....	A-43
BIBD6005.....	A-46	BIBS25010MT.....	A-47	BIBS43FX.....	A-52
BIBD6005FX.....	A-55	BIBS25012.....	A-43	BIBS44.....	A-43
BIBD6006.....	A-46	BIBS25012FX.....	A-52	BIBS44FX.....	A-52
BIBD6006FX.....	A-55	BIBS25012FXMT.....	A-56	BIBS45.....	A-43
BIBD6006FXMT.....	A-57	BIBS25012MT.....	A-47	BIBS45FX.....	A-52
BIBD6006MT.....	A-48	BIBS25014.....	A-43	BIBS46.....	A-43
BIBD6008.....	A-46	BIBS25014FX.....	A-52	BIBS46FX.....	A-52
BIBD6008FX.....	A-55	BIBS2503.....	A-43	BIBS48.....	A-43
BIBD6008FXMT.....	A-57	BIBS2503FX.....	A-52	BIBS48FX.....	A-52
BIBD6008MT.....	A-48	BIBS2504.....	A-43	BIBS5003DB.....	A-40
BIBD75010.....	A-46	BIBS2504FX.....	A-52	BIBS5004DB.....	A-40
BIBD75010HDFX.....	A-55	BIBS2504FXMT.....	A-56	BIBS5005DB.....	A-40
BIBD75012.....	A-46	BIBS2504MT.....	A-47	BIBS5006DB.....	A-40
BIBD75012HDFX.....	A-55	BIBS2505.....	A-43	BIBS60010.....	A-44
BIBD75014.....	A-46	BIBS2505FX.....	A-52	BIBS60010FX.....	A-53
BIBD75014HDFX.....	A-55	BIBS2506.....	A-43	BIBS60010MT.....	A-47
BIBD7502.....	A-46	BIBS2506FX.....	A-52	BIBS60012.....	A-44
BIBD7502HDFX.....	A-55	BIBS2506FXMT.....	A-56	BIBS60012FX.....	A-53
BIBD7503.....	A-46	BIBS2506MT.....	A-47	BIBS60012FXMT.....	A-56
BIBD7503HDFX.....	A-55	BIBS2508.....	A-43	BIBS60012MT.....	A-47
BIBD7504.....	A-46	BIBS2508FX.....	A-52	BIBS60014.....	A-44
BIBD7504HDFX.....	A-55	BIBS2508FXMT.....	A-56	BIBS60014FX.....	A-53
BIBD7506.....	A-46	BIBS2508MT.....	A-47	BIBS6003.....	A-44
BIBD7506HDFX.....	A-55	BIBS35010.....	A-43	BIBS6003FX.....	A-53
BIBD7508.....	A-46	BIBS35010FX.....	A-52	BIBS6004.....	A-44
BIBD7508HDFX.....	A-55	BIBS35010FXMT.....	A-56	BIBS6004FX.....	A-53
BIBS2/010.....	A-43	BIBS35010MT.....	A-47	BIBS6004FXMT.....	A-56
BIBS2/010FX.....	A-52	BIBS35012.....	A-43	BIBS6004MT.....	A-47
BIBS2/010FXMT.....	A-56	BIBS35012FX.....	A-52	BIBS6005.....	A-44
BIBS2/010MT.....	A-47	BIBS35012FXMT.....	A-56	BIBS6005FX.....	A-53
BIBS2/012.....	A-43	BIBS35012MT.....	A-47	BIBS6006.....	A-44
BIBS2/012FX.....	A-52	BIBS35014.....	A-43	BIBS6006FX.....	A-53
BIBS2/012FXMT.....	A-56	BIBS35014FX.....	A-52	BIBS6006FXMT.....	A-56
BIBS2/012MT.....	A-47	BIBS3502DB.....	A-40	BIBS6006MT.....	A-47
BIBS2/014.....	A-43	BIBS3503.....	A-43	BIBS6008.....	A-44
BIBS2/014FX.....	A-52	BIBS3503DB.....	A-40	BIBS6008FX.....	A-53
BIBS2/03.....	A-43	BIBS3503FX.....	A-52	BIBS6008FXMT.....	A-56
BIBS2/03FX.....	A-52	BIBS3504.....	A-43	BIBS6008MT.....	A-47
BIBS2/04.....	A-43	BIBS3504DB.....	A-40	BIBS75010.....	A-44
BIBS2/04FX.....	A-52	BIBS3504FX.....	A-52	BIBS75010HDFX.....	A-53
BIBS2/04FXMT.....	A-56	BIBS3504FXMT.....	A-56	BIBS75012.....	A-44
BIBS2/04MT.....	A-47	BIBS3504MT.....	A-47	BIBS75012HDFX.....	A-53
BIBS2/05.....	A-43	BIBS3505.....	A-43	BIBS75014.....	A-44

ALPHA-NUMERIC INDEX BY CATALOG NUMBER

BIBS75014HDFX	A-53	BIT750HDFX	A-51	BYNA245MM2THACCC	I-21
BIBS7503	A-44	BITO2/0	A-42	BYNA32R15HT	I-8
BIBS7503HDFX	A-53	BITO2/0FX	A-51	BYNA32RHT	I-8
BIBS7504	A-44	BITO250	A-42	BYNA32RT15HACCC	I-18, I-21
BIBS7504HDFX	A-53	BITO250FX	A-51	BYNA32RT15HT	I-9
BIBS7506	A-44	BITO350	A-42	BYNA32RTHACCC	I-21
BIBS7506HDFX	A-53	BITO350FX	A-51	BYNA32RTHT	I-9
BIBS7508	A-44	BITO4	A-42	BYNA34R15HT	I-8
BIBS7508HDFX	A-53	BITO4FX	A-51	BYNA34RHT	I-8
BIBSD506FXMT	A-57	BITO600	A-42	BYNA34RT15HT	I-9
BIPC1/010SC	A-11-12	BITO600FX	A-51	BYNA34RTHT	I-9
BIPC1/02	A-13	BITO750	A-42	BYNA36R15HT	I-8
BIPC1/08SC	A-11-12	BITO750HDFX	A-51	BYNA36RHT	I-8
BIPC2/014S	A-11-12	BMCSS6W17	E-171	BYNA36RT15HACCC	I-18, I-21
BIPC2504SC	A-11-12	BMCSS8W17	E-171	BYNA36RT15HT	I-9
BIPC3501/0SC	A-11-12	BMESH2015	D-9	BYNA36RTHACCC	I-21
BIPC350350	A-13	BMYBCHMT	N-53	BYNA36RTHT	I-9
BIPC3504/0	A-13	BRAID GA 4 SLDR BLOCKED 16"	D-9	BYNA39R15HT	I-8
BIPC4/01/0	A-13	BRAID GA 6 SLDR BLOCKED 16"	D-9	BYNA39RHT	I-8
BIPC4/010S	A-11-12	BRAID GA 8 SLDR BLOCKED 16"	D-9	BYNA39RT15HACCC	I-18, I-21
BIPC4/06	A-13	BS10	B-51	BYNA39RT15HT	I-9
BIPC5001/0S	A-11-12	BS14	B-51	BYNA39RTHACCC	I-21
BIPC50010SC	A-11-12	BS16	B-51	BYNA39RTHT	I-9
BIPC5004/0	A-13	BSD20100	E-73	BYNA43R15HT	I-8
BIPC5004/0SC	A-11-12	BSD2050	E-73	BYNA43RHT	I-8
BIPC5004SC	A-11-12	BSD2050K01	E-73	BYNA43RT15HACCC	I-18, I-21
BIPC75014	A-11-12	BSD2050K02	E-73	BYNA43RT15HT	I-9
BIPC750250SC	A-11-12	BSD2050K03	E-73	BYNA43RTHACCC	I-21
BIPC7502SC	A-11-12	BSD2050K04	E-73	BYNA43RTHT	I-9
BISR1/0	A-42	BSD2050K05	E-73	BYNA45R15HT	I-8
BISR1/0FX	A-50	BSD2050K05N	E-73	BYNA45RHT	I-8
BISR1DB	A-39	BSD2050K05Y	E-73	BYNA45RT15HACCC	I-18, I-22
BISR2	A-42	BSD2050K06	E-73	BYNA45RT15HT	I-9
BISR250	A-42	BSD2050N	E-73	BYNA45RTHACCC	I-22
BISR250DB	A-39	BSD2050Y	E-73	BYNA45RTHT	I-9
BISR250FX	A-50	BSDCCEE	E-74	BYNA49R15HT	I-8
BISR2FX	A-50	BTCGC1/0SS	E-76	BYNA49RHT	I-8
BISR3/0DB	A-39	BTCGC250	E-76	BYNA49RT15HACCC	I-19, I-22
BISR350	A-42	BTCGC250SS	E-76	BYNA49RT15HT	I-9
BISR350FX	A-50	BTCGC4SS	E-76	BYNA49RTHACCC	I-22
BISR4DB	A-39	BTW150750	A-40, N-107	BYNA49RTHT	I-9
BISR500	A-42	BTW1575F12	N-107	BYNA52R15HT	I-8
BISR500FX	A-50	BTW30150	A-40, N-107	BYNA52RHT	I-8
BISR750HDFX	A-50	BULF14P	B-78	BYNA52RT15HACCC	I-19, I-22
BIT2/0	A-42	BULF18P	B-78	BYNA52RT15HT	I-9
BIT2/0FX	A-51	BULM14P	B-78	BYNA52RTHACCC	I-22
BIT250	A-42	BULM18P	B-78	BYNA52RTHT	I-9
BIT250FX	A-51	BWB680AG	E-63	BYNA56R15HT	I-8
BIT350	A-42	BWB680IG	E-63	BYNA56RHT	I-8
BIT350FX	A-51	BYNA106MM2T15HACCC	I-18	BYNA56RT15HACCC	I-19, I-22
BIT4	A-42	BYNA160MM2T15HACCC	I-21	BYNA56RT15HT	I-9
BIT4FX	A-51	BYNA160MM2THACCC	I-21	BYNA56RTHACCC	I-22
BIT600	A-42	BYNA235MMT15HACCC	I-18, I-21	BYNA56RTHT	I-9
BIT600FX	A-51	BYNA235MMTHACCC	I-21	BYNA58R15HT	I-8
BIT750	A-42	BYNA245MM2T15HACCC	I-18, I-21	BYNA58RHT	I-8

ALPHA-NUMERIC INDEX BY CATALOG NUMBER

BYNA58RT15HT.....	I-9	C-61.....	E-57	CCSC146900.....	D-2
BYNA58RTHT.....	I-9	C-66.....	E-57	CCSC2001200.....	D-2
BYNA590MRT15HACCC.....	I-19, I-22	C-6D.....	E-57	CCSC200600.....	D-2
BYNA590MRTHACCC.....	I-22	C-7.....	E-57	CCSC200900.....	D-2
BYNA59R15HT.....	I-8	C-8.....	E-54	CCSC251200.....	D-2
BYNA59RHT.....	I-8	CASEPATCUT1500.....	N-83	CCSC25600.....	D-2
BYNA59RT15HACCC.....	I-19, I-22		N-68-70,	CCSC25900.....	D-2
BYNA59RT15HT.....	I-9	CASEUDIES15.....	N-104	CCY106LT12G.....	E-88
BYNA59RTHACCC.....	I-22	CASEUDIES8.....	N-103, N-104	CCY10L12LT1090G.....	E-88
BYNA59RTHT.....	I-9	CASEWDIES.....	N-72	CCY10L12LT14GY.....	E-88
BYNA760MRT15HACCC.....	I-19, I-22	CASEWDIES.....	N-71	CCY10L12LT38G.....	E-88
BYNA760MRTHACCC.....	I-22	CB1412P.....	E-109	CCY10L12T12G.....	E-88
BYNS32RTHT.....	I-10	CB14210P.....	E-101	CCY10L14LT14GY.....	E-88
BYNS34RTHT.....	I-10	CB14210PK.....	E-101	CCY10L18LT1090G.....	E-88
BYNS36RTHT.....	I-10	CB14210S.....	E-104	CCY10L18LT14GY.....	E-88
BYNS39RTHT.....	I-10	CB14212P.....	E-101	CCY10L18LT38G.....	E-88
BYNS43RTHT.....	I-10	CB14212PK.....	E-101, E-109	CCY10L18T12G.....	E-88
BYNS451RTHT.....	I-10	CB14212S.....	E-104	CCY10L24LT1090G.....	E-88
BYNS49RTHT.....	I-10	CB14212YK.....	E-106	CCY10L24LT38G.....	E-88
BYNS52RTHT.....	I-10	CB14216S.....	E-104	CCY10L24T12G.....	E-88
BYNS56RTHT.....	I-10	CB14220S.....	E-104	CCY10L6LT38G.....	E-88
BYNS58RTHT.....	I-10	CB1426S.....	E-104	CCY10L7T14GY.....	E-88
BYNS59RTHT.....	I-10	CB14412J.....	E-108	CCY10L9LT38G.....	E-88
C-11B.....	E-54	CB14412JK.....	E-101, E-108	CCY10L9T12G.....	E-88
C-11CSH-1.....	E-58	CB14412M.....	E-101, E-108	CCY10L9T14GY.....	E-88
C-11CSH-2.....	E-58	CB14412MK.....	E-101, E-108	CFDFR.....	C-218
C-11CSH-3.....	E-58	CB14412S.....	E-105	CFNFR.....	C-218
C11CSLH12.....	E-58	CB14412SK.....	E-105	CFOFR.....	C-218
C-11D.....	E-54	CB14412YK.....	E-106	CFRFR.....	C-218
C11HD4/0DB.....	E-56	CB14416S.....	E-105	CH11C.....	G-14
C-11JA.....	E-56	CB14420J.....	E-108	CH11M.....	G-14
C-11JPT.....	E-54	CB14420JK.....	E-108	CH12C.....	G-14
C11K16D.....	E-55	CB14420M.....	E-108	CH12C0.....	G-14
C11K17D.....	E-55	CB14420MK.....	E-108	CH12M.....	G-14
C-11LH-1.....	E-58	CB14420S.....	E-105	CH12M0.....	G-14
C-11LH-2.....	E-58	CB14424J.....	E-108	CH16C.....	G-14
C-11LH-3.....	E-58	CB14424JK.....	E-108	CH16M.....	G-14
C-11N.....	E-54	CB14424M.....	E-108	CH18C.....	G-14
C-22.....	E-54	CB14424MK.....	E-108	CH18M.....	G-14
C-22D.....	E-54	CB14424S.....	E-105	CH24C.....	G-14
C22HD4/0DB.....	E-56	CCD.....	H-27	CH24C0.....	G-14
C-22JA.....	E-56	CCFBGFR.....	C-223	CH24L.....	G-14
C-22JPT.....	E-54	CCFDFR.....	C-218, C-223	CH2C.....	G-14
C-22LH-1.....	E-58	CCFDXFR.....	C-218, C-223	CH2C0.....	G-14
C-22LH-2.....	E-58	CCFNFR.....	C-218, C-223	CH2M.....	G-14
C-22LH-3.....	E-58	CCFOFR.....	C-218, C-223	CH3C.....	G-14
C-4.....	E-54	CCFRFR.....	C-218, C-223	CH3C0.....	G-14
C-4D.....	E-54	CCN.....	H-27	CH3M.....	G-14
C-4JA.....	E-56	CCNL.....	H-27	CH4C.....	G-14
C-4JPT.....	E-54	CCO.....	H-27	CH4C0.....	G-14
C-4LH-1.....	E-58	CCSC110600.....	D-2	CH4M.....	G-14
C-4LH-2.....	E-58	CCSC110800.....	D-2	CH4M0.....	G-14
C-4LH-3.....	E-58	CCSC126600.....	D-2	CH5C.....	G-14
C-5.....	E-55	CCSC126900.....	D-2	CH5C0.....	G-14
C-6.....	E-57	CCSC146600.....	D-2	CH5M.....	G-14

ALPHA-NUMERIC INDEX BY CATALOG NUMBER

CH6C.....	G-14	CS3CI2835250500J.....	D-8	CT110600SSBC.....	G-16
CH6CO.....	G-14	CS3CI5820350J.....	D-8	CT110600SSBCO.....	G-16
CH6M.....	G-14	CS3CI58220J.....	D-8	CT110600SSBL.....	G-16
CH6MO.....	G-14	CS3CO2528140B.....	D-7	CT110600SSBL0.....	G-16
CH8C.....	G-14	CS3CO2528250500B.....	D-7	CT110800SSBC.....	G-16
CH8CO.....	G-14	CS3CO2835250500B.....	D-7	CT110800SSBCO.....	G-16
CH8M.....	G-14	CS3CO5820350B.....	D-7	CT110800SSBL.....	G-16
CL1/014TN.....	A-22	CS3CO58220B.....	D-7	CT110800SSBL0.....	G-16
CL1/0-14TN.....	E-35	CSB037800SR1.....	D-3	CT120200D.....	G-8
CL250516TN.....	A-22	CSB051900SR1.....	D-3	CT120200D0.....	G-8
CL250-516TN.....	E-35	CSB0971200SR1.....	D-3	CT120200L.....	G-8
CL3/0516TN.....	A-22	CSB097900SR1.....	D-3	CT120200L0.....	G-8
CL3/0-516TN.....	E-35	CSB125900SR1.....	D-3	CT120200LOUG.....	G-18
CL501.....	A-22	CSB163900SR1.....	D-3	CT120300SSBC.....	G-16
CL50-1.....	E-35	CSGO15210.....	D-5	CT120300SSBCO.....	G-16
CL501TN.....	A-22	CSGO252810250.....	D-5	CT120300SSBL.....	G-16
CL50-1TN.....	E-35	CSGO2528140.....	D-5	CT120300SSBL0.....	G-16
CL50-1TN BULK.....	E-35	CSGO3550015.....	D-5	CT120350SSBC.....	G-16
CL501TNMHWSS.....	E-35	CSGO355001500.....	D-5	CT120350SSBCO.....	G-16
CL501TNMHWSSST.....	E-35	CSJB097600SR1.....	D-3	CT120350SSBL.....	G-16
CMDT120400C5.....	G-11	CSJB125800SR1.....	D-3	CT120350SSBL0.....	G-16
CMDT18075C5.....	G-11	CSJB163900SR1.....	D-3	CT120400COUG.....	G-18
CMDT40225C5.....	G-11	CSUDO15210J.....	D-6	CT120400D.....	G-8
CMDT50175C5.....	G-11	CSUDO252810250J.....	D-6	CT120400D0.....	G-8
CMDT50300C5.....	G-11	CSUDO2528140J.....	D-6	CT120400D00.....	G-8
CMDT50400C5.....	G-11	CSUDO3510350J.....	D-6	CT120400L.....	G-8
COVERYA3BLK.....	F-13	CSUDO355001500J.....	D-6	CT120400L0.....	G-8
COVERYA3ORG.....	F-13	CT110200SSBB.....	G-16	CT120400L00.....	G-8
COVERYA4BLK.....	F-13	CT110200SSBB0.....	G-16	CT120400LOUG.....	G-18
COVERYA4ORG.....	F-13	CT110200SSBC.....	G-16	CT120400LUG.....	G-18
COVERYA5BLK.....	F-13	CT110200SSBCO.....	G-16	CT120400MO.....	G-8
COVERYA5ORG.....	F-13	CT110225SSBC.....	G-16	CT120400MH14D.....	G-12
COVERYA6BLK.....	F-13	CT110225SSBCO.....	G-16	CT120400MH14D0.....	G-12
COVERYA6ORG.....	F-13	CT110225SSBL.....	G-16	CT120400MH14L.....	G-12
CP2525.....	H-13	CT110225SSBL0.....	G-16	CT120400MH14L0.....	G-12
CP2626.....	H-13	CT110300SSBC.....	G-16	CT120400MH14L0.....	G-12
CP26A26A.....	H-11	CT110300SSBCO.....	G-16	CT120400SSBC.....	G-16
CP27A27A.....	H-11	CT110300SSBL.....	G-16	CT120400SSBL.....	G-16
CP2828.....	H-13	CT110300SSBL0.....	G-16	CT120400SSBL0.....	G-16
CP28A28A.....	H-11	CT110325SSBB.....	G-16	CT120500CUG.....	G-18
CP2929.....	H-13	CT110325SSBB0.....	G-16	CT120500SSBC.....	G-16
CP29A29A.....	H-11	CT110325SSBC.....	G-16	CT120500SSBCO.....	G-16
CP2C2C.....	H-13	CT110325SSBCO.....	G-16	CT120500SSBL.....	G-16
CP30A30A.....	H-11	CT110350SSBC.....	G-16	CT120500SSBL0.....	G-16
CP31A31A.....	H-11	CT110350SSBCO.....	G-16	CT120800L.....	G-8
CP32A32A.....	H-11	CT110350SSBL.....	G-16	CT120800L00.....	G-8
CP3434.....	H-13	CT110350SSBL0.....	G-16	CT120900LUG.....	G-18
CP34A34A.....	H-11	CT110400SSBC.....	G-16	CT1751100Q.....	G-9
CP37A37A.....	H-11	CT110400SSBCO.....	G-16	CT1751100Q0.....	G-9
CPR42A4.....	L-40	CT110400SSBL.....	G-16	CT1751100Q0UG.....	G-18
CPR46A4.....	L-40	CT110400SSBL0.....	G-16	CT1751100QUG.....	G-18
CS34BLKTAPE.....	D-10	CT110500SSBC.....	G-16	CT1751400Q0.....	G-9
CS34REDTAPE.....	D-10	CT110500SSBCO.....	G-16	CT1751400QUG.....	G-18
CS3CI2528140J.....	D-8	CT110500SSBL.....	G-16	CT1751500Q.....	G-9
CS3CI2528250500J.....	D-8	CT110500SSBL0.....	G-16	CT175400Q0UG.....	G-18

ALPHA-NUMERIC INDEX BY CATALOG NUMBER

CT175500Q.....	G-9	CT2501000RQ.....	G-11	CT40400C0.....	G-7
CT175500Q0.....	G-9	CT2501200Q.....	G-9	CT40400C00.....	G-7
CT175600Q.....	G-9	CT2501200Q0.....	G-9	CT40400C0UG.....	G-17
CT175600Q0.....	G-9	CT250200RQ.....	G-11	CT40400M.....	G-7
CT175600Q0UG.....	G-18	CT250200RQ0.....	G-11	CT40400M0.....	G-7
CT175600QUG.....	G-18	CT250500RQ.....	G-11	CT40400M00.....	G-7
CT175800Q0.....	G-9	CT250500RQ0.....	G-11	CT40400SSBC.....	G-15
CT175900Q.....	G-9	CT250600Q.....	G-9	CT40400SSBC0.....	G-15
CT175900Q00.....	G-9	CT250600Q0.....	G-9	CT40400SSBD.....	G-15
CT175900Q0UG.....	G-18	CT250600RQ.....	G-11	CT40400SSBD0.....	G-15
CT18025M0UG.....	G-17	CT250600RQ0.....	G-11	CT50137RC.....	G-11
CT18025MUG.....	G-17	CT250800Q.....	G-9	CT50175C.....	G-7
CT18075C.....	G-6	CT250800Q0.....	G-9	CT50175C0.....	G-7
CT18075C0.....	G-6	CT250800Q0UG.....	G-18	CT50175C00.....	G-7
CT18075C00.....	G-6	CT250800RQ.....	G-11	CT50175C0UG.....	G-17
CT18075C0UG.....	G-17	CT250800RQ0.....	G-11	CT50175C1.....	G-7
CT18075CUG.....	G-17	CT30125C.....	G-6	CT50175C2.....	G-7
CT18075FLC.....	G-10	CT30125C0.....	G-6	CT50175C3.....	G-7
CT18075IDC.....	G-10	CT30125C00.....	G-6	CT50175C4.....	G-7
CT18075M.....	G-6	CT30125C0UG.....	G-17	CT50175C5.....	G-7
CT18075M0.....	G-6	CT30125CUG.....	G-17	CT50175C6.....	G-7
CT18075M00.....	G-6	CT30125M.....	G-6	CT50175C7.....	G-7
CT18075MH4C.....	G-12	CT30125M0.....	G-6	CT50175C8.....	G-7
CT18075MH4M.....	G-12	CT30125M00.....	G-6	CT50175CUG.....	G-17
CT18087SSBC.....	G-15	CT30125MH8C.....	G-12	CT50175IDC.....	G-10
CT18087SSBC0.....	G-15	CT30125MH8M.....	G-12	CT50175M.....	G-7
CT18087SSBM.....	G-15	CT30125MH8M0.....	G-12	CT50175M0.....	G-7
CT18087SSBM0.....	G-15	CT30125MUG.....	G-17	CT50175M00.....	G-7
CT18100SSBC.....	G-15	CT40137SSBC.....	G-15	CT50175M02.....	G-7
CT18100SSBC0.....	G-15	CT40137SSBC0.....	G-15	CT50175M0UG.....	G-17
CT18100SSBM.....	G-15	CT40137SSBM.....	G-15	CT50175MH10C.....	G-12
CT18100SSBM0.....	G-15	CT40137SSBM0.....	G-15	CT50175MH10C0.....	G-12
CT18125C.....	G-6	CT40200C.....	G-7	CT50175MH10C0UG.....	G-19
CT18125C0.....	G-6	CT40200C0.....	G-7	CT50175MH10CUG.....	G-19
CT18125C3.....	G-6	CT40200C00.....	G-7	CT50175MH10M.....	G-12
CT18125C4.....	G-6	CT40200CUG.....	G-17	CT50175MH10M0.....	G-12
CT18125M.....	G-6	CT40200M.....	G-7	CT50175MUG.....	G-17
CT18125M0.....	G-6	CT40200M0.....	G-7	CT50175PMC.....	G-10
CT18200C.....	G-6	CT40200M00.....	G-7	CT50175PMC0.....	G-10
CT18200C0.....	G-6	CT40200MUG.....	G-17	CT50175RC.....	G-11
CT18200C0UG.....	G-17	CT40200SSBC.....	G-15	CT50175RC0.....	G-11
CT18200C1.....	G-6	CT40200SSBC0.....	G-15	CT50175SSBC.....	G-15
CT18200C2.....	G-6	CT40200SSBD.....	G-15	CT50175SSBC0.....	G-15
CT18200C5.....	G-6	CT40200SSBD0.....	G-15	CT50175SSBD.....	G-15
CT18200C6.....	G-6	CT40300C.....	G-7	CT50175SSBD0.....	G-15
CT18200IDC.....	G-10	CT40300C0.....	G-7	CT50200SSBB.....	G-15
CT18200M.....	G-6	CT40300C00.....	G-7	CT50200SSBB0.....	G-15
CT18200M0.....	G-6	CT40300M.....	G-7	CT50200SSBC.....	G-15
CT18200M0UG.....	G-17	CT40300M0.....	G-7	CT50200SSBC0.....	G-15
CT18200MUG.....	G-17	CT40300M00.....	G-7	CT50250IDC.....	G-10
CT18200SSBC.....	G-15	CT40300SSBC.....	G-15	CT50250SSBB.....	G-15
CT18200SSBC0.....	G-15	CT40300SSBC0.....	G-15	CT50250SSBB0.....	G-15
CT18200SSBM.....	G-15	CT40300SSBD.....	G-15	CT50250SSBC.....	G-15
CT18200SSBM0.....	G-15	CT40300SSBD0.....	G-15	CT50250SSBC0.....	G-15
CT2501000Q.....	G-9	CT40400C.....	G-7	CT50300C.....	G-8

ALPHA-NUMERIC INDEX BY CATALOG NUMBER

CT50300C0.....	G-8	CTB100RAF2L.....	G-13	CTSS450300PC304L.....	G-23
CT50300C00.....	G-8	CTB100SF2C.....	G-13	CTSS450400FC304L.....	G-24
CT50300C0UG.....	G-17	CTB125RA4C.....	G-13	CTSS450400PC304L.....	G-23
CT50300C2.....	G-8	CTB125RA4CUG.....	G-19	CTSS450500FC304L.....	G-24
CT50300CUG.....	G-17	CTB125RA4DUG.....	G-19	CTSS450500PC304L.....	G-23
CT50300M.....	G-8	CTB150AAF3C.....	G-13	CTSS450600FC304L.....	G-24
CT50300M0.....	G-8	CTB150AAF3D.....	G-13	CTSS450600PC304L.....	G-23
CT50300M00.....	G-8	CTB150RA4C.....	G-13	CTSS450700FC304L.....	G-24
CT50300M0UG.....	G-17	CTB150RAF3C0.....	G-13	CTSS450700PC304L.....	G-23
CT50300MH10C0UG.....	G-19	CTB150RAF3D.....	G-13	CTSS450800FC304L.....	G-24
CT50300MH10CUG.....	G-19	CTB150SF3C.....	G-13	CTSS450800PC304L.....	G-23
CT50300MUG.....	G-17	CTFT50200C0.....	G-10	CTSS500200304L.....	G-22
CT50300SSBB.....	G-15	CTHS120400M.....	G-12	CTSS500300304L.....	G-22
CT50300SSBB0.....	G-15	CTHS18075M.....	G-12	CTSS500400304L.....	G-22
CT50300SSBC.....	G-15	CTHS40125M.....	G-12	CTSS500500304L.....	G-22
CT50300SSBC0.....	G-15	CTHS50300M.....	G-12	CTSS500600304L.....	G-22
CT50400C.....	G-8	CTHS50400M.....	G-12	CTSS500700304L.....	G-22
CT50400C0.....	G-8	CTHS50700M.....	G-12	CTSS500750304L.....	G-22
CT50400C00.....	G-8	CTNT120600L0.....	G-20	CTSS500800304L.....	G-22
CT50400C0UG.....	G-17	CTNT50200C0.....	G-20	CTSS675200FC304Q.....	G-24
CT50400C2.....	G-8	CTNT50200D0.....	G-20	CTSS675200PC304Q.....	G-23
CT50400C3.....	G-8	CTNT50275C0.....	G-20	CTSS675300FC304Q.....	G-24
CT50400CUG.....	G-17	CTNT50275D0.....	G-20	CTSS675300PC304Q.....	G-23
CT50400M.....	G-8	CTNT50350C0.....	G-20	CTSS675400FC304Q.....	G-24
CT50400M0.....	G-8	CTNT50350D0.....	G-20	CTSS675400PC304Q.....	G-23
CT50400M00.....	G-8	CTSS100100FC304C.....	G-24	CTSS675500FC304Q.....	G-24
CT50400M02.....	G-8	CTSS100200FC304C.....	G-24	CTSS675500PC304Q.....	G-23
CT50400MH10C.....	G-12	CTSS100300FC304C.....	G-24	CTSS675600FC304Q.....	G-24
CT50400MH10C0.....	G-12	CTSS100400FC304C.....	G-24	CTSS675600PC304Q.....	G-23
CT50400MH10M0.....	G-12	CTSS100500FC304C.....	G-24	CTSS675700FC304Q.....	G-24
CT50400MUG.....	G-17	CTSS100600FC304C.....	G-24	CTSS675700PC304Q.....	G-23
CT50400RC.....	G-11	CTSS100800FC304C.....	G-24	CTSS675800FC304Q.....	G-24
CT50400RC0.....	G-11	CTSS225100304C.....	G-22	CTSS675800PC304Q.....	G-23
CT50400SSBB.....	G-16	CTSS225200304C.....	G-22	CTSS700200304L.....	G-22
CT50400SSBB0.....	G-16	CTSS225300304C.....	G-22	CTSS700300304L.....	G-22
CT50400SSBC.....	G-16	CTSS225400304C.....	G-22	CTSS700400304L.....	G-22
CT50400SSBC0.....	G-16	CTSS225500304C.....	G-22	CTSS700500304L.....	G-22
CT50425SSBB.....	G-16	CTSS225600304C.....	G-22	CTSS700600304L.....	G-22
CT50425SSBB0.....	G-16	CTSS250200FC304L.....	G-24	CTSS700700304L.....	G-22
CT50425SSBC.....	G-16	CTSS250200PC304L.....	G-23	CTSS700800304L.....	G-22
CT50425SSBC0.....	G-16	CTSS250300FC304L.....	G-24	CTSS900200304L.....	G-22
CTASST.....	G-20	CTSS250300PC304L.....	G-23	CTSS900300304L.....	G-22
CTB075AAF1C.....	G-13	CTSS250400FC304L.....	G-24	CTSS900400304L.....	G-22
CTB075AAF1C0.....	G-13	CTSS250400PC304L.....	G-23	CTSS900500304L.....	G-22
CTB075AAF1M.....	G-13	CTSS250500FC304L.....	G-24	CTSS900600304L.....	G-22
CTB075RA4CUG.....	G-19	CTSS250500PC304L.....	G-23	CTSS900700304L.....	G-22
CTB075RAF1C.....	G-13	CTSS250600FC304L.....	G-24	CTSS900800304L.....	G-22
CTB075RAF1C0.....	G-13	CTSS250600PC304L.....	G-23	CTTSS900.....	G-30
CTB075RAF1M.....	G-13	CTSS250700FC304L.....	G-24	CTZ100300C6.....	G-21
CTB075SF1C.....	G-13	CTSS250700PC304L.....	G-23	CTZ100400C6.....	G-21
CTB075SF1M.....	G-13	CTSS250800FC304L.....	G-24	CTZ18075C6.....	G-21
CTB100AAF2C.....	G-13	CTSS250800PC304L.....	G-23	CTZ18125C6.....	G-21
CTB100AAF2C0.....	G-13	CTSS450200FC304L.....	G-24	CTZ30200C6.....	G-21
CTB100AAF2D.....	G-13	CTSS450200PC304L.....	G-23	CTZ50175C6.....	G-21
CTB100RAF2C0.....	G-13	CTSS450300FC304L.....	G-24	CTZ50300C6.....	G-21

ALPHA-NUMERIC INDEX BY CATALOG NUMBER

CTZ50400C6.....	G-21	ES25A4W.....	H-46	FL1825X03B.....	B-69
CUSA442NTC.....	C-156	ES25R25R.....	H-46	FL1825X03D.....	B-69
CUSA442TC38.....	C-156	ES25R2R.....	H-46	FLN1025X03D.....	B-69
CUT200BLMVBL.....	N-74, N-86	ES25R2W.....	H-46	FLN1425X03D.....	B-69
CUT200BLSTA.....	N-74, N-86	ES25R4W.....	H-46	FLN1825X03D.....	B-69
CUW26RE1.....	H-75	ES25R6W.....	H-46	FORCEGAUGE11.....	N-105
CUW30AE.....	H-75	ES2R2R.....	H-46	FORCEGAUGE1215.....	N-105
CUW32RE.....	H-75	ES2R2W.....	H-46	FP10.....	N-97
CUW34E.....	H-74	ES2R4W.....	H-46	FP6.....	N-97
CUW361RE.....	H-75	ES2R6W.....	H-46	FQN10F25X03D.....	B-65
CUW391AE.....	H-75	ES2R8W.....	H-46	FQN10M25X03B.....	B-64
CUW44E.....	H-74	ES2W2W.....	H-46	FQN10M25X03D.....	B-64
CY1CL14D50LT38.....	E-93	ES2W4W.....	H-46	FQN14F18X02D.....	B-65
CZ-11.....	E-55	ES2W6W.....	H-46	FQN14F25X03D.....	B-65
DEV25L.....	N-39	ES2W8W.....	H-46	FQN14M18X02D.....	B-64
DEV26L.....	N-39	ES4W4W.....	H-46	FQN14M25X03B.....	B-64
DEV2L.....	N-39	ES4W6W.....	H-46	FQN14M25X03D.....	B-64
DEV4L.....	N-39	ES4W8W.....	H-46	FQN18F25X03D.....	B-65
DEV6L.....	N-39	ES6W6W.....	H-46	FQN18M18X02D.....	B-64
DEV8L.....	N-39	ES6W8W.....	H-46	FQN18M25X03B.....	B-64
Die Profiles.....	N-61	ES8W8W.....	H-46	FQN18M25X03D.....	B-64
DUW28.....	H-74	FCB632NP300.....	A-10, L-10	FQP10F25X03D.....	B-64
DUW28A.....	H-75	FCB634N.....	A-10, L-10	FQP14F11X03D.....	B-64
DUW31.....	H-74	FCB636N.....	A-10, L-10	FQP14F18X02D.....	B-64
DUW34.....	H-74	FCB6444NP50.....	A-10, L-10	FQP14F25X03D.....	B-64
DUW44.....	H-74	FCB644N.....	A-10, L-10	FQP18F11X03D.....	B-64
DUW44A.....	H-75	FCB646N.....	A-10, L-10	FQP18F18X02D.....	B-64
DUW44AE.....	H-75	FCB654N.....	A-10, L-10	FQP18F25X03D.....	B-64
DV1L.....	N-39	FD64C5T16.....	L-37	GA25H26.....	E-48
DV25L.....	N-39	FD655C6.....	L-37	GA25H29.....	E-48
DV26L.....	N-39	FD655D6.....	L-37	GA400H294CTN.....	E-48
DV2L.....	N-39	FD65C6T14.....	L-37	GA600H30SS.....	E-48
DV4L.....	N-39	FD66C6.....	L-37	GA800H30SS.....	E-48
DV6L.....	N-39	FD66D6.....	L-37	GAR1126.....	E-39
DV8L1.....	N-39	FD675C8.....	L-37	GAR1129.....	E-39
E2C34G1.....	H-41, L-10	FD675D8.....	L-37	GAR114C.....	E-39
E3C34G1.....	H-41, L-10	FD685C8.....	L-37	GAR1426.....	E-39
E4C34G1.....	H-41, L-10	FD685D12.....	L-37	GAR1429.....	E-39
EA25.....	A-16	FD68C8.....	L-37	GAR1434.....	E-39
EA28.....	A-16	FD68D12.....	L-37	GAR144C.....	E-39
EA282N.....	A-16	FD68D8.....	L-37	GAR1526.....	E-39
EA2C.....	A-16	FD69C8.....	L-37	GAR1529.....	E-39
EA34.....	A-16	FD69D12.....	L-37	GAR1534.....	E-39
EA342N.....	A-16	FD69D8.....	L-37	GAR154C.....	E-39
EP10.....	N-95	FD70D12.....	L-37	GAR1626.....	E-39
EP101HP.....	N-95	FD70D16.....	L-37	GAR1629.....	E-39
EP101HP2.....	N-95	FFGC2.....	E-47	GAR1634.....	E-39
EP102.....	N-95	FFGC2/0.....	E-47	GAR164C.....	E-39
EPAC10.....	N-96	FFGC4.....	E-47	GAR1726.....	E-40
EPP10.....	N-94	FFGC6.....	E-47	GAR1729.....	E-40
EPPCASE1.....	N-94	FFGC8.....	E-47	GAR1734.....	E-40
EQC632C.....	H-42	FL1025X03B.....	B-69	GAR174C.....	E-40
EQC632C1.....	E-32	FL1025X03D.....	B-69	GAR1826.....	E-40
ES25A25A.....	H-46	FL1425X03B.....	B-69	GAR1829.....	E-40
ES25A2W.....	H-46	FL1425X03D.....	B-69	GAR1834.....	E-40

ALPHA-NUMERIC INDEX BY CATALOG NUMBER

GAR184C.....	E-40	GB26.....	E-70	GD174C.....	E-43
GAR1926.....	E-40	GB29.....	E-70	GD1826.....	E-43
GAR1929.....	E-40	GB34.....	E-70	GD1829.....	E-43
GAR1934.....	E-40	GB468B.....	E-113	GD1834.....	E-43
GAR194C.....	E-40	GB4C.....	E-70	GD184C.....	E-43
GAR2026.....	E-40	GBL30.....	E-70	GD1926.....	E-43
GAR2029.....	E-40	GBM26.....	E-70	GD1929.....	E-43
GAR2034.....	E-40	GBM29.....	E-70	GD1934.....	E-43
GAR204C.....	E-40	GBM34.....	E-70	GD194C.....	E-43
GAR2126.....	E-40	GBM4C.....	E-70	GD2026.....	E-43
GAR2129.....	E-40	GC15A.....	E-59	GD2029.....	E-43
GAR2134.....	E-40	GC18A.....	E-59	GD2034.....	E-43
GAR214C.....	E-40	GC22A.....	E-59	GD204C.....	E-43
GAR2226.....	E-40	GC2525CT.....	E-76	GD2126.....	E-43
GAR2229.....	E-40	GC2626.....	E-70	GD2129.....	E-43
GAR2234.....	E-40	GC2626CT.....	E-76	GD2134.....	E-43
GAR224C.....	E-40	GC2929.....	E-70	GD214C.....	E-43
GAR2426.....	E-40	GC2929CT.....	E-76	GD2226.....	E-43
GAR2429.....	E-40	GC3434.....	E-70	GD2229.....	E-43
GAR2434.....	E-40	GC3434CT.....	E-76	GD2234.....	E-43
GAR244C.....	E-40	GC4C4C.....	E-70	GD224C.....	E-43
GAR3902.....	E-41	GCB63T13G1.....	E-74	GG15-1.....	E-46
GAR3902-BU.....	E-41	GCL30.....	E-70	GG16-1.....	E-46
GAR3902TC.....	E-42	GCM26.....	E-70	GG17-1.....	E-46
GAR3903.....	E-41	GCM29.....	E-70	GG17-15.....	E-46
GAR3903-BU.....	E-41	GCM34.....	E-70	GG18-1.....	E-46
GAR3903TC.....	E-42	GCM4C.....	E-70	GG18-15.....	E-46
GAR3904.....	E-41	GCRT1/0.....	E-33	GG18-2.....	E-46
GAR3904-BU.....	E-41	GCS26HEX.....	E-36	GG19-2.....	E-46
GAR3904TC.....	E-42	GCS29HEX.....	E-36	GG19-25.....	E-46
GAR3905.....	E-41	GCS2YA1C.....	E-38	GG20-2.....	E-46
GAR3905-BU.....	E-41	GCS2YA25.....	E-38	GG20-25.....	E-46
GAR3905TC.....	E-42	GCS2YA26.....	E-38	GG20-3.....	E-46
GAR3906.....	E-41	GCS2YA2C.....	E-38	GG21-2.....	E-46
GAR3906-BU.....	E-41	GCS2YA3C.....	E-38	GG21-25.....	E-46
GAR3906TC.....	E-42	GCS2YA4C.....	E-38	GG21-3.....	E-46
GAR3907.....	E-41	GCS2YA6C.....	E-38	GG21-35.....	E-46
GAR3907-BU.....	E-41	GCS2YA8C.....	E-38	GG22-2.....	E-46
GAR3907TC.....	E-42	GCS34HEX.....	E-36	GG22-25.....	E-46
GAR3908.....	E-41	GCSL28HEX.....	E-36	GG22-3.....	E-46
GAR3908-BU.....	E-41	GCSYA1CWEEB.....	E-37	GG22-4.....	E-46
GAR3908TC.....	E-42	GCSYA25WEEB.....	E-37	GG24-2.....	E-46
GAR3909.....	E-41	GCSYA26WEEB.....	E-37	GIB5.....	E-61
GAR3909-BU.....	E-41	GCSYA2CWEEB.....	E-37	GIE2CG3.....	E-72
GAR3909TC.....	E-42	GCSYA3CWEEB.....	E-37	GIE4CG3.....	E-72
GAR6426.....	E-39	GCSYA4CWEEB.....	E-37	GIE4CG3P5.....	E-72
GAR6429.....	E-39	GCSYA6CWEEB.....	E-37	GIE4CG3P7.....	E-72
GAR6434.....	E-39	GCSYA8CWEEB.....	E-37	GIE4CG4.....	E-72
GAR644C.....	E-39	GD1526.....	E-43	GIE4CG4P5.....	E-72
GAR8629.....	E-40	GD1529.....	E-43	GIE4CG4P7.....	E-72
GAR8634.....	E-40	GD1626.....	E-43	GK1126.....	E-45
GB105012801.....	E-113	GD1629.....	E-43	GK1129.....	E-45
GB1230126.....	E-113	GD1726.....	E-43	GK114C.....	E-45
GB150G2.....	E-65	GD1729.....	E-43	GK1426.....	E-45
GB150G3.....	E-65	GD1734.....	E-43	GK1429.....	E-45

ALPHA-NUMERIC INDEX BY CATALOG NUMBER

GK1434.....	E-45	GQ26-1.....	E-51	HFB54P1.....	L-44
GK1526.....	E-45	GQ2626.....	E-51	HFB55P1.....	L-44
GK1529.....	E-45	GQ29-1.....	E-51	HFB62P1.....	L-44
GK1626.....	E-45	GQ2929.....	E-51	HFB63P1.....	L-44
GK1629.....	E-45	GRC12.....	E-33	HFB64P1.....	L-44
GK1726.....	E-45	GRC34.....	E-33	HFB666N.....	L-44
GK1729.....	E-45	GRC58.....	E-33	HIW716ENFKIT2.....	N-112
GK1826.....	E-45	GRF4C-3.....	E-78	HIW716ENFKIT3.....	N-112
GK1829.....	E-45	GRF4C-4.....	E-78	HIW716ENFTGKIT.....	N-112
GK1926.....	E-45	GRL3.....	E-33	HIW716ENFTGKIT1.....	N-112
GK1929.....	E-45	GRL4.....	E-33	HIW716MAGKIT1.....	N-113
GK6426.....	E-45	GRL5.....	E-33	HIW716MAGKIT2.....	N-113
GK6429.....	E-45	GRL6.....	E-33	HIW716MAGKIT3.....	N-113
GK6434.....	E-45	GROUNDAB1/2.....	E-19	HP10.....	N-97
GK644C.....	E-45	GROUNDAB3/8.....	E-19	HS_100FR.....	D-17
GKA25.....	E-34	GSC632NH1B.....	E-75	HS_100FR100.....	D-17
GKA25SB.....	E-34	GSC632NH1BCOVER1.....	E-75	HS_100T300PF.....	D-14
GKA28.....	E-34	GSC632NH25B5H.....	E-75	HS_100T48PF.....	D-13
GKA28SB.....	E-34	GSC752N30B.....	E-75	HS_112FR.....	D-17
GKA4C.....	E-34	GSC752N30B45.....	E-75	HS_112FR100.....	D-17
GKA8C.....	E-34	GSC752N30B5H.....	E-75	HS_116T300PF.....	D-14
GL2626.....	E-71	GSC752N30B90.....	E-75	HS_116T48PF.....	D-13
GL2929.....	E-71	GSC7530BCOVER.....	E-75	HS_12FR.....	D-17
GL3434.....	E-71	GSTUD14HY.....	E-25	HS_12FR250.....	D-17
GL4C4C.....	E-71	GSTUD34HY.....	E-25	HS_12T300PF.....	D-14
GM4666.....	E-113	GSTUD38HY.....	E-25	HS_12T48PF.....	D-13
GM4666C1/OS.....	E-113	GSTUD916HY.....	E-25	HS_14FR.....	D-17
GNAH292N.....	E-64	GX2626.....	E-51	HS_14FR250.....	D-17
GP10.....	N-98	GX264C.....	E-51	HS_14T300PF.....	D-14
GP1126.....	E-44	GX2926.....	E-51	HS_14T48PF.....	D-13
GP1129.....	E-44	GX2929.....	E-51	HS_150T48PF.....	D-13
GP114C.....	E-44	GX294C.....	E-51	HS_18FR.....	D-17
GP1426.....	E-44	GX3426.....	E-51	HS_18FR250.....	D-17
GP1429.....	E-44	GX3429.....	E-51	HS_18T300PF.....	D-14
GP1434.....	E-44	GX3434.....	E-51	HS_18T48PF.....	D-13
GP144C.....	E-44	GX344C.....	E-51	HS_200FR.....	D-17
GP1526.....	E-44	GX4C4C.....	E-51	HS_200FR100.....	D-17
GP1526G1.....	E-79	GXP1828RF.....	E-77	HS_200T48PF.....	D-13
GP154C.....	E-44	GZ26-12.....	E-71	HS_316T300PF.....	D-14
GP1629.....	E-44	GZ26-38.....	E-71	HS_316T48PF.....	D-13
GP164C.....	E-44	GZ26-58.....	E-71	HS_332T300PF.....	D-14
GP1726.....	E-44	GZ29-12.....	E-71	HS_332T48PF.....	D-13
GP1726G1.....	E-79	GZ29-38.....	E-71	HS_34FR.....	D-17
GP1726RT.....	E-79	GZ29-58.....	E-71	HS_34FR250.....	D-17
GP1826.....	E-44	GZ4C-12.....	E-71	HS_34T300PF.....	D-14
GP184C.....	E-44	GZ4C-38.....	E-71	HS_34T48PF.....	D-13
GP2026.....	E-44	GZ4C-58.....	E-71	HS_38FR.....	D-17
GP2226.....	E-44	HFB22P1.....	L-44	HS_38FR250.....	D-17
GP6426.....	E-44	HFB334N.....	L-44	HS_38T300PF.....	D-14
GP6429.....	E-44	HFB33P1.....	L-44	HS_38T48PF.....	D-13
GP6434.....	E-44	HFB444N.....	L-44	HSB100T6PF7.....	D-12
GP644C.....	E-44	HFB44G30W.....	L-43	HSB110H48PF5.....	D-15
GP64526G1.....	E-79	HFB44G31W.....	L-43	HSB110H6PF5.....	D-15
GP64528G1.....	E-79	HFB44G32W.....	L-43	HSB110H9PF5.....	D-15
GP654CG1.....	E-79	HFB44P1.....	L-44	HSB11612T6PF14.....	D-12

ALPHA-NUMERIC INDEX BY CATALOG NUMBER

HSB116T6PF26.....	D-12	HTC100-4A.....	J-37	K22A39U2.....	A-29
HSB12T6PF10.....	D-12	HTC100A.....	J-37	K22A39U2N.....	A-30
HSB14T6PF14.....	D-12	HTC10B.....	J-38	K2A25U.....	A-27
HSB150H12PF3.....	D-15	HTC11B.....	J-38	K2A26U.....	A-27
HSB150H48PF5.....	D-15	HTC200.....	J-36	K2A29U.....	A-27
HSB150H9PF3.....	D-15	HTC200-4.....	J-36	K2A31U.....	A-27
HSB18T6PF20.....	D-12	HTC200-4A.....	J-37	K2A31U2N.....	A-27
HSB200H12PF2.....	D-15	HTC200A.....	J-37	K2A36U.....	A-27
HSB200H48PF2.....	D-15	HTC20B.....	J-38	K2A36U2N.....	A-27
HSB200H9PF2.....	D-15	HTC212A.....	J-37	K2A40U.....	A-27
HSB316T6PF18.....	D-12	HTC300.....	J-36	K2A40U2N.....	A-27
HSB332T6PF24.....	D-12	HTC300A.....	J-37	K2A44U.....	A-27
HSB34H48PF5.....	D-15	HTC30B.....	J-38	K2A44U2N.....	A-27
HSB34H6PF10.....	D-15	HTC32B.....	J-38	K2C15.....	E-30
HSB34H9PF10.....	D-15	HTC350A.....	J-37	K2C15B1.....	E-30
HSB34T6PF8.....	D-12	HYA_28.....	K-48	K2C17.....	E-30
HSB35H3PF25.....	D-15	HYA_29.....	K-48	K2C17B1.....	E-30
HSB35H48PF5.....	D-15	HYA_31.....	K-48	K2C20.....	E-30
HSB35H6PF25.....	D-15	HYA_34.....	K-48	K2C20B1.....	E-30
HSB38100T6PF8.....	D-12	HYA_39.....	K-48	K2C22.....	E-30
HSB38T6PF12.....	D-12	HYAO_28.....	K-48	K2C22B1.....	E-30
HSC100FR.....	D-16	HYAO_29.....	K-48	K2C23.....	E-30
HSC100FR100.....	D-16	HYAO_31.....	K-48	K2C23B1.....	E-30
HSC112FR.....	D-16	HYAO_34.....	K-48	K2C25.....	E-30
HSC112FR100.....	D-16	HYAO_39.....	K-48	K2C25B1.....	E-30
HSC12FR.....	D-16	HYFLUIDGAL.....	N-104	K2C26.....	E-30
HSC12FR250.....	D-16	HYFLUIDQT.....	N-104	K2C26B1.....	E-30
HSC14FR.....	D-16	HYM_28.....	K-48	K2C28.....	E-30
HSC14FR250.....	D-16	HYM_29.....	K-48	K2C28B1.....	E-30
HSC18FR.....	D-16	HYM_31.....	K-48	K2C28G3.....	E-30
HSC18FR250.....	D-16	HYM_34.....	K-48	K2C31.....	E-30
HSC200FR.....	D-16	HYM_39.....	K-48	K2C31B1.....	E-30
HSC200FR100.....	D-16	HYS_28.....	K-48	K2C34.....	E-30
HSC34FR.....	D-16	HYS_29.....	K-48	K2C34B1.....	E-30
HSC34FR250.....	D-16	HYS_31.....	K-48	K3A25U2.....	A-28
HSC38FR.....	D-16	HYS_34.....	K-48	K3A25U4.....	A-28
HSC38FR250.....	D-16	HYS_39.....	K-48	K3A26U2N.....	A-28
HSIC10500FR.....	D-18	J1252.....	H-39	K3A27U2N.....	A-28
HSIC200FR.....	D-18	J278.....	E-65	K3A27U4N.....	A-28
HSIC301000FR.....	D-18	J278G1.....	E-65	K3A29U2N.....	A-28
HSIC350FR.....	D-18	J279.....	E-65	K3A29U4N.....	A-28
HSIC440FR.....	D-18	J280.....	E-65	K3A2U2.....	A-28
HSIC81FR.....	D-18	J295.....	E-65	K3A2U4.....	A-28
HSKIT.....	B-80	J990.....	H-39	K3A31U2N.....	A-28
HSM100T6PF7.....	D-12	K11A30U.....	A-29	K3A31U4N.....	A-28
HSM116T6PF26.....	D-12	K11A34U2.....	A-29	K3A36U2N.....	A-28
HSM12T6PF10.....	D-12	K11A36U2.....	A-29	K3A36U4N.....	A-28
HSM14T6PF14.....	D-12	K11A36U2N.....	A-30	K3A40U4N.....	A-28
HSM18T6PF20.....	D-12	K11A39U2.....	A-29	K4A29U4N.....	A-29
HSM316T6PF18.....	D-12	K11A39U2N.....	A-30	K4A31U4N.....	A-29
HSM332T6PF24.....	D-12	K21A36U2.....	A-29	K6A34U8.....	A-31
HSM34T6PF8.....	D-12	K21A36U2N.....	A-30	K6P28.....	K-56
HSM38T6PF12.....	D-12	K21A39U2N.....	A-30	K6P28C.....	K-56
HTC100.....	J-36	K22A36U2.....	A-29	K8A34U10.....	A-31
HTC100-4.....	J-36	K22A36U2N.....	A-30	KA25.....	A-16

ALPHA-NUMERIC INDEX BY CATALOG NUMBER

KA252TC38.....	A-16	KC20B1.....	E-30	KLU300TP.....	A-15
KA25U.....	A-26	KC22.....	E-30	KLU35.....	A-15
KA26U.....	A-26	KC22B1.....	E-30	KLU35TP.....	A-15
KA28.....	A-16	KC22J12T13.....	E-32, H-42	KLU400.....	A-15
KA29U.....	A-26	KC23.....	E-30	KLU400TP.....	A-15
KA2U.....	A-26	KC23B1.....	E-30	KLU70.....	A-15
KA30226U.....	A-26	KC25.....	E-30	KLU70TP.....	A-15
KA30U.....	A-26	KC25B1.....	E-30	KPA25.....	A-14
KA31U.....	A-26		E-30, E-32,	KPA28.....	A-14
KA34.....	A-16	KC26.....	H-42	KPA34.....	A-14
KA34U.....	A-26	KC26B1.....	E-30	KPA4C.....	A-14
KA36229U.....	A-26	KC28.....	E-30	KPA4CUP.....	A-14
KA36U.....	A-26	KC28B1.....	E-30	KPA8C.....	A-14
KA36U2N.....	A-26	KC31.....	E-30	KPA8CUP.....	A-14
KA39230U.....	A-26	KC31B1.....	E-30	KPB4CG1.....	E-34
KA40U.....	A-26	KC34.....	E-30	KPC28.....	K-56
KA40U2N.....	A-26	KC34B1.....	E-30	KPU1C.....	A-36
KA44U.....	A-26	KC34J12T13.....	E-32, H-42	KPU2929T.....	A-36
KA44U2N.....	A-26	KCKF23.....	E-31	KPU2929TC.....	A-36
KA4C.....	A-16	KCKF25.....	E-31	KPU2C4CT.....	A-36
KA6U.....	A-26	KCKF28.....	E-31	KPU2C4CTC.....	A-36
KA8C.....	A-16	KK12A39U10SNP.....	A-32	KPU3434T.....	A-36
KAP1/O.....	A-34	KK3A36U2N.....	A-28	KPU3434TC.....	A-36
KAP250R.....	A-34	KK3A36U4N.....	A-28	KPU3C.....	A-36
KAP350.....	A-34	KK3A40U2N.....	A-28	KPU5C.....	A-36
KAP350R.....	A-34	KK3A40U4N.....	A-28	KS15.....	A-3, E-32, H-4
KAP500R.....	A-34	KK3A44U2N.....	A-28	KS17.....	A-3, E-32, H-4
KAP750.....	A-34	KK3A44U4N.....	A-28	KS173.....	A-3, H-4
KAPO1/O.....	A-34	KK4A36U4N.....	A-29	KS20.....	A-3, E-32, H-4
KAPO250R.....	A-34	KK4A39U8LNP.....	A-32	KS203.....	A-3, H-4
KAPO350.....	A-34	KK4A40U4N.....	A-29	KS22.....	A-3, E-32, H-4
KAPO350R.....	A-34	KK4A44U8LNP.....	A-32	KS223.....	A-3, H-4
KAPO500R.....	A-34	KK6A31U8.....	A-31	KS23.....	A-3, E-32, H-4
KAPO750.....	A-34	KK6A34U8.....	A-31	KS25.....	A-3, E-32, H-4
KASB28U12.....	A-25	KK6A39U12LNP.....	A-32	KS26.....	A-3, E-32, H-4
KASB28U2N.....	A-25	KK6A39U6SNP.....	A-32	KS27.....	A-3, E-32, H-4
KASB31U12.....	A-25	KK6A44U12.....	A-31	KS29.....	A-3, E-32, H-4
KASB31U2N.....	A-25	KK6A44U12LNP.....	A-32	KS31.....	A-3, E-32, H-4
KASB34U12.....	A-25	KK8A31U10.....	A-31	KS34.....	A-3, E-32, H-4
KASB34U2N.....	A-25	KK8A34U10.....	A-31	KS39.....	A-3, H-4
KASB39U12.....	A-25	KK8A39U12.....	A-31	KS44.....	A-3, H-4
KASB39U2N.....	A-25	KK8A39U16LNP.....	A-32	KS90.....	A-3, H-4
KASB44U12.....	A-25	KK8A39U8SNP.....	A-32	KSA1/O.....	A-5
KASB44U2N.....	A-25	KK8A44U14.....	A-31	KSA2.....	A-5
KASB45U12.....	A-25	KK8A44U16LNP.....	A-32	KSA2/O.....	A-5
KASB45U2N.....	A-25	KKA31U2N.....	A-26	KSA350.....	A-5
KAUKIT1.....	A-33	KLU125.....	A-15	KSA4.....	A-5
KAUKIT2.....	A-33	KLU125TP.....	A-15	KSA4/O.....	A-5
KAUKIT3.....	A-33	KLU175.....	A-15	KSA500.....	A-5
KAUKIT4.....	A-33	KLU175TP.....	A-15	KSA6.....	A-5
KC15.....	E-30	KLU225.....	A-15	KSSB28U.....	A-25
KC15B1.....	E-30	KLU225TP.....	A-15	KSSB31U.....	A-25
KC17.....	E-30	KLU25.....	A-15	KSSB34U.....	A-25
KC17B1.....	E-30	KLU25TP.....	A-15	KSSB39U.....	A-25
KC20.....	E-30	KLU300.....	A-15	KSSB44U.....	A-25

ALPHA-NUMERIC INDEX BY CATALOG NUMBER

KSSB45U.....	A-25	LF1025.....	K-40-42	LYS26C.....	K-40
KSU17.....	A-4, H-5	LF2019.....	K-40-42	LYS26P5.....	K-44
KSU20.....	A-4, H-5	LF2027.....	K-40-42	LYS27C.....	K-40
KSU22.....	A-4, H-5	LF2038.....	K-40-42	LYS27P5.....	K-44
KSU23.....	A-4, H-5	LF2065.....	K-40-42	LYS28C.....	K-40
KSU25.....	A-4, H-5	LF2108.....	K-42	LYS28P5.....	K-44
KSU26.....	A-4, H-5	LH283.....	L-32	LYS29C.....	K-40
KSU27.....	A-4, H-5	LH343.....	L-32	LYS29P5.....	K-44
KSU29.....	A-4, H-5	LH453.....	L-32	LYS2CC.....	K-40
KSU31.....	A-4, H-5	LPC12S.....	N-115	LYS2CP5.....	K-44
KSU34.....	A-4, H-5	LPHTADPMM71612.....	N-113, N-115	LYS30C.....	K-40
KVS26.....	A-6, H-6	LPHTADPMMOP66.....	N-112, N-115	LYS30P5.....	K-44
KVS26A.....	A-7, H-8	LPHTADPMMOP66.....	N-113	LYS31C.....	K-40
KVS28.....	A-6, H-6	LPHTADPSMFOP66.....	N-112-114	LYS31P5.....	K-44
KVS28A.....	A-7, H-8	LPHTBIT111618D.....	N-111	LYS32C.....	K-40
KVS31.....	A-6, H-6	LPHTBIT111624D.....	N-111	LYS32P5.....	K-44
KVS31A.....	A-7, H-8	LPHTBIT131618D.....	N-111	LYS32P6.....	K-45
KVS34.....	A-6, H-6	LPHTBIT131624D.....	N-111	LYS34C.....	K-40
KVS34A.....	A-7, H-8	LPHTBIT151618D.....	N-111	LYS34P2.....	K-43
KVS40.....	A-6, H-6	LPHTBIT151624D.....	N-111	LYS34P5.....	K-44
KVS40A.....	A-7, H-8	LPHTBIT3418D.....	N-111	LYS48P6.....	K-45
KVS44.....	A-6, H-6	LPHTBIT5818D.....	N-111	LYS4CC.....	K-40
KVS44A.....	A-7, H-8	LPHTBIT91618D.....	N-111	LYS4CP5.....	K-44
KVSU26.....	A-6, H-7	LPHTDRIPBODY66.....	N-115	LYS64P6.....	K-45
KVSU28.....	A-6, H-7	LPHTDRIPNOSE66.....	N-115	LYS6CP5.....	K-44
KVSU31.....	A-6, H-7	LPHTHOSNCR666610.....	N-113-115	LYS80P6.....	K-45
KVSU34.....	A-6, H-7	LPHTHOSNCR666610OP.....	N-114-115	M-1208.....	E-125
KVSU40.....	A-6, H-7	LPHTHOSNCR666668.....	N-112-115	M-1212.....	E-130
KVSU44.....	A-6, H-7	LPHTHOSNCR666668OP.....	N-114-115	M-1215.....	E-134
KVSW26.....	A-7, H-6	LPHTHTMABODY66.....	N-112-114	M-1216.....	E-134
KVSW28.....	A-7, H-6	LPHTHTMADUSTCAPF.....	N-115	M-1218.....	E-134
KVSW31.....	A-7, H-6	LPHTHTMADUSTCAPM.....	N-115	M-1219.....	E-134
KVSW34.....	A-7, H-6	LPHTHTMANOSE66.....	N-112-114	M-1220.....	E-134
KVSW40.....	A-7, H-6	LPHY750XT.....	N-114	M-1221.....	E-134
KVSW44.....	A-7, H-6	LSC1/0.....	H-20	M-1222.....	E-134
LB16A.....	L-35	LSC1/01.....	H-20	M-1223.....	E-134
LB18A.....	L-35	LSC556.....	H-20	M-1224.....	E-134
LB19A.....	L-35	LSC5561.....	H-20	M-1225-H.....	E-134
LB20A.....	L-35	LYBASEH.....	K-43	M-1226-H.....	E-134
LB21A.....	L-35	LYM1CC.....	K-41	M-1228-H.....	E-134
LB22A.....	L-35	LYM25C.....	K-41	M-1270.....	E-124
LB23A.....	L-35	LYM26C.....	K-41	M-1271.....	E-124
LB24A.....	L-35	LYM27C.....	K-41	M-1272.....	E-124
LB55A.....	L-35	LYM28C.....	K-41	M-1273.....	E-124
LB58A.....	L-35	LYM29C.....	K-41	M-1274.....	E-124
LB83A.....	L-35	LYM2CC.....	K-41	M-1275.....	E-124
LB86A.....	L-35	LYM30C.....	K-41	M-1276.....	E-124
LB88A.....	L-35	LYM31C.....	K-41	M-1277.....	E-124
LB91A.....	L-35	LYM32C.....	K-41	M-1278.....	E-124
LB92A.....	L-35	LYM34C.....	K-41	M-1279.....	E-124
LB94A.....	L-35	LYM34P3.....	K-45	M-1280.....	E-124
LB96A.....	L-35	LYS1CC.....	K-40	M-1281.....	E-124
LF1006.....	K-42	LYS1CP5.....	K-44	M-1282.....	E-124
LF1010.....	K-40, K-42	LYS25C.....	K-40	M-1283.....	E-124
LF1014.....	K-40-42	LYS25P5.....	K-44	M-1284.....	E-124

ALPHA-NUMERIC INDEX BY CATALOG NUMBER

M-1285.....	E-124	M-1586.....	E-128	M-209.....	E-120
M-1286.....	E-124	M-1587.....	E-128	M-210.....	E-120
M-1287.....	E-124	M-1588.....	E-128	M-211.....	E-120
M-1288.....	E-124	M-1589.....	E-128	M-213.....	E-120
M-1289.....	E-124	M-1593.....	E-128	M-214.....	E-120
M-1290.....	E-124	M-1594.....	E-128	M-215.....	E-120
M-1291.....	E-124	M-1595.....	E-128	M-2154.....	E-128
M-1292.....	E-124	M-1596.....	E-128	M-2155.....	E-128
M-1293.....	E-124	M-1597.....	E-128	M-2156.....	E-128
M-1294.....	E-124	M-1601.....	E-128	M-2157.....	E-128
M-1295.....	E-124	M-1602.....	E-128	M-2158.....	E-128
M-1296.....	E-124	M-1603.....	E-128	M-2159.....	E-128
M-1297.....	E-124	M-1604.....	E-128	M-2160.....	E-128
M-1298.....	E-124	M-1605.....	E-128	M-2161.....	E-128
M-1299.....	E-124	M-1606.....	E-128	M-2162.....	E-128
M-1300.....	E-124	M-1610.....	E-128	M-2163.....	E-128
M-1301.....	E-124	M-1611.....	E-128	M-2164.....	E-128
M-1302.....	E-124	M-1613.....	E-136	M-2165.....	E-128
M-1303.....	E-124	M-1614.....	E-136	M-2189.....	E-134
M-1304.....	E-124	M-1615.....	E-136	M-2199.....	E-131
M-1305.....	E-124	M-1616.....	E-136	M-2200.....	E-131
M-1306.....	E-124	M-1617.....	E-136	M-221.....	E-121
M-1307.....	E-124	M-1618.....	E-136	M-223.....	E-121
M-1308.....	E-124	M-1619.....	E-136	M-2235.....	E-130
M-1309.....	E-124	M-1620.....	E-136	M-224.....	E-121
M-1310.....	E-124	M-1626.....	E-135	M-225.....	E-121
M-1311.....	E-125	M-1627.....	E-135	M-226.....	E-121
M-1313.....	E-125	M-1628.....	E-135	M-227.....	E-121
M-1314.....	E-125	M-1629.....	E-135	M-228.....	E-121
M-1315.....	E-125	M-1630.....	E-135	M-229.....	E-121
M-1316.....	E-125	M-1631.....	E-135	M-230.....	E-121
M-1317.....	E-125	M-1632.....	E-135	M-231.....	E-121
M-1318.....	E-125	M-1633.....	E-135	M-232.....	E-121
M-1319.....	E-125	M-1634.....	E-135	M-2320.....	E-130
M-1320.....	E-125	M-1635.....	E-135	M-234.....	E-121
M-1321.....	E-125	M-1636.....	E-135	M-235.....	E-121
M-1322.....	E-125	M-1637.....	E-135	M-236.....	E-121
M-1323.....	E-125	M-1638.....	E-135	M-237.....	E-121
M-1324.....	E-125	M-1639.....	E-135	M-238.....	E-121
M-1325.....	E-125	M-1640.....	E-135	M-239.....	E-121
M-1326.....	E-125	M-1641.....	E-135	M-240.....	E-121
M-1327.....	E-125	M-1642.....	E-135	M-241.....	E-121
M-1328.....	E-125	M1643.....	E-135	M-242.....	E-121
M-1329.....	E-125	M-1644.....	E-135	M-243.....	E-121
M-1330.....	E-125	M-1645.....	E-135	M-244.....	E-121
M-1331.....	E-125	M-1646.....	E-135	M-245.....	E-121
M-1332.....	E-125	M-1648.....	E-135	M-2450.....	E-130
M-1333.....	E-125	M-1649.....	E-135	M-246.....	E-121
M-1334.....	E-125	M-1650.....	E-135	M-247.....	E-121
M-1335.....	E-125	M20.....	H-73	M-2476.....	E-133
M-1336.....	E-125	M-205.....	E-120	M-2477.....	E-133
M-1581.....	E-128	M-206.....	E-120	M-2478.....	E-133
M-1582.....	E-128	M-207.....	E-120	M-248.....	E-121
M-1583.....	E-128	M-208.....	E-120	M-2480.....	E-133
M-1584.....	E-128	M-2084.....	E-130	M-2480-S.....	E-133

ALPHA-NUMERIC INDEX BY CATALOG NUMBER

M-2482	E-133	M-2696	E-123	M-423	E-122
M-2483	E-133	M-2697	E-123	M-424	E-122
M-2484	E-133	M-2698	E-123	M-425	E-122
M-2486	E-133	M-2699	E-123	M-426	E-122
M-2487	E-133	M-2700	E-121	M-427	E-122
M-2488	E-133	M-2701	E-123	M-428	E-122
M-249	E-121	M-2702	E-123	M-429	E-122
M-2490	E-133	M-2703	E-123	M-430	E-122
M-2491	E-133	M-2704	E-123	M-431	E-122
M-2493	E-133	M-2705	E-123	M-432	E-122
M-2494	E-133	M-2706	E-123	M-433	E-122
M-2495	E-133	M-2707	E-123	M-434	E-122
M-2497	E-133	M-2708	E-123	M-435	E-122
M-2498	E-133	M-2709	E-123	M-436	E-122
M-250	E-121	M-2710	E-123	M-437	E-122
M-2506	E-131	M-2711	E-123	M-438	E-122
M-2507	E-131	M-2712	E-123	M-439	E-122
M-2509	E-131	M-2713	E-123	M-440	E-122
M-251	E-121	M-2714	E-123	M-441	E-122
M-2510	E-130	M-2715	E-123	M-442	E-122
M-2511	E-131	M-2716	E-123	M-443	E-122
M-252	E-121	M-2717	E-123	M-444	E-122
M-253	E-121	M-2718	E-123	M-445	E-122
M-254	E-121	M-2719	E-123	M-446	E-122
M-2540	E-134	M-2747	E-123	M-447	E-122
M-2542	E-131	M-2751	E-123	M-448	E-122
M-255	E-121	M-2752	E-123	M-449	E-122
M-2558	E-130	M-2753	E-123	M-450	E-122
M-256	E-121	M-2754	E-123	M-451	E-122
M-2566	E-129	M-2755	E-123	M-452	E-122
M-2567	E-136	M-2756	E-123	M-453	E-122
M-2568	E-136	M-2757	E-123	M-454	E-122
M-257	E-121	M-2761	E-136	M-455	E-122
M-258	E-121	M-2781	E-134	M-456	E-122
M-2583	E-133	M-280	E-121	M-457	E-122
M-2583-S	E-133	M-282	E-121	M-458	E-122
M-259	E-121	M-283	E-121	M-459	E-122
M-260	E-121	M-284	E-121	M-460	E-122
M-261	E-121	M-285	E-121	M-461	E-122
M-262	E-121	M-286	E-121	M-462	E-122
M-263	E-121	M-287	E-121	M-463	E-122
M-264	E-121	M-288	E-121	M-464	E-122
M-265	E-121	M-289	E-121	M-465	E-122
M-266	E-121	M-290	E-121	M-466	E-122
M-267	E-121	M-291	E-121	M-467	E-122
M-268	E-121	M-293	E-121	M-468	E-122
M-2687	E-123	M-294	E-121	M-469	E-122
M-2689	E-123	M-295	E-121	M-470	E-122
M-269	E-121	M-296	E-121	M-471	E-122
M-2690	E-123	M-297	E-121	M-472	E-122
M-2691	E-123	M-298	E-121	M-483	E-122
M-2692	E-123	M30	H-73	M-485	E-122
M-2693	E-123	M-333	E-121	M-486	E-122
M-2694	E-123	M40	H-73	M-487	E-122
M-2695	E-123			M-488	E-122

ALPHA-NUMERIC INDEX BY CATALOG NUMBER

M-489.....	E-122	M-534.....	E-126	M-562.....	E-127
M-490.....	E-122	M-5340.....	E-125	M-5623.....	E-120
M-491.....	E-122	M-5341.....	E-130	M-5624.....	E-120
M-492.....	E-122	M-5342.....	E-125	M-5625.....	E-120
M-493.....	E-122	M-535.....	E-126	M-5626.....	E-120
M-495.....	E-126	M-5351.....	E-130	M-5627.....	E-125
M-496.....	E-126	M-5352.....	E-130	M-5629.....	E-125
M-497.....	E-126	M-5353.....	E-130	M-563.....	E-127
M-498.....	E-126	M-5359.....	E-134	M-5630.....	E-125
M-499.....	E-126	M-5361.....	E-134	M-5631.....	E-125
M50.....	H-73	M-5362.....	E-134	M-5632.....	E-125
M-500.....	E-126	M-5363.....	E-134	M-5634.....	E-125
M-501.....	E-126	M-537.....	E-127	M-5635.....	E-125
M-502.....	E-126	M-538.....	E-127	M-5636.....	E-125
M-5021.....	E-121	M-5380.....	E-129	M-5637.....	E-125
M-503.....	E-126	M-5389.....	E-134	M-5638.....	E-125
M-504.....	E-126	M-539.....	E-127	M-5639.....	E-125
M-505.....	E-126	M-5390.....	E-129	M-564.....	E-127
M-506.....	E-126	M-540.....	E-127	M-5640.....	E-130
M-5065.....	E-132	M-541.....	E-127	M-5642.....	E-125
M-507.....	E-126	M-5416.....	E-129	M-5644.....	E-125
M-508.....	E-126	M-5419.....	E-136	M-5645.....	E-125
M-509.....	E-126	M-542.....	E-127	M-5652.....	E-125
M-510.....	E-126	M-5428.....	E-130	M-5659.....	E-125
M-511.....	E-126	M-543.....	E-127	M-566.....	E-127
M-513.....	E-126	M-5432.....	E-123	M-5660.....	E-128
M-514.....	E-126	M-544.....	E-127	M-5667.....	E-130
M-515.....	E-126	M-545.....	E-127	M-5668.....	E-125
M-516.....	E-126	M-546.....	E-127	M-567.....	E-127
M-517.....	E-126	M-547.....	E-127	M-5676.....	E-125
M-518.....	E-126	M-5475.....	E-121	M-5677.....	E-130
M-519.....	E-126	M-548.....	E-127	M-5679.....	E-125
M-520.....	E-126	M-549.....	E-127	M-5680.....	E-125
M-521.....	E-126	M-550.....	E-127	M-5682.....	E-125
M-523.....	E-126	M-551.....	E-127	M-5684.....	E-125
M-524.....	E-126	M-5513.....	E-129	M-5686.....	E-125
M-525.....	E-126	M-5515.....	E-129	M-5688.....	E-125
M-526.....	E-126	M-5517.....	E-130	M-569.....	E-127
M-527.....	E-126	M-552.....	E-127	M-5698.....	E-129
M-528.....	E-126	M-553.....	E-127	M-5699.....	E-129
M-529.....	E-126	M-555.....	E-127	M-570.....	E-127
M-5294.....	E-129	M-5555.....	E-129	M-5702.....	E-130
M-530.....	E-126	M-5556.....	E-129	M-5709.....	E-124
M-531.....	E-126	M-556.....	E-127	M-571.....	E-127
M-5321.....	E-128	M-5560.....	E-130	M-572.....	E-127
M-533.....	E-126	M-5561.....	E-129	M-5722.....	E-129
M-5330.....	E-130	M-557.....	E-127	M-573.....	E-127
M-5331.....	E-132	M-5573.....	E-130	M-5732.....	E-129
M-5332.....	E-130	M-5574.....	E-121	M-5734.....	E-129
M-5333.....	E-130	M-558.....	E-127	M-5738.....	E-129
M-5334.....	E-130	M-559.....	E-127	M-574.....	E-127
M-5335.....	E-130	M-560.....	E-127	M-5746.....	E-129
M-5336.....	E-130	M-5604.....	E-130	M-575.....	E-127
M-5337.....	E-130	M-561.....	E-127	M-5767.....	E-130
M-5338.....	E-130	M-5618.....	E-124	M-577.....	E-127

ALPHA-NUMERIC INDEX BY CATALOG NUMBER

M-5777.....	E-129	M-6165.....	E-129	M-7530.....	E-137
M-578.....	E-127	M-617.....	E-132	M-7531.....	E-137
M-5781.....	E-126	M-618.....	E-132	M-7588.....	E-138
M-579.....	E-127	M-619.....	E-132	M-7589.....	E-138
M-5803.....	E-129	M-620.....	E-132	M-7590.....	E-138
M-5807.....	E-129	M-6208.....	E-130	M-7591.....	E-138
M-5820.....	E-129	M-621.....	E-132	M-7592.....	E-138
M-5821.....	E-129	M-622.....	E-132	M-7593.....	E-138
M-5830.....	E-129	M-624.....	E-132	M-7594.....	E-138
M-5833.....	E-129	M-625-H.....	E-132	M-7595.....	E-138
M-585.....	E-133	M-626-H.....	E-132	M-7596.....	E-138
M-5850.....	E-129	M-628.....	E-131	M-7597.....	E-138
M-5857.....	E-129	M-629.....	E-131	M-7598.....	E-138
M-586.....	E-133	M-630.....	E-131	M-7599.....	E-138
M-587.....	E-133	M-631.....	E-131	M-7600.....	E-138
M-5877.....	E-129	M-644.....	E-131	M-7601.....	E-138
M-588.....	E-133	M-645.....	E-131	M-7602.....	E-138
M-588-S.....	E-133	M-646.....	E-131	M-7603.....	E-138
M-589.....	E-133	M-647.....	E-131	M-7604.....	E-138
M-590.....	E-133	M-648.....	E-131	M-7605.....	E-138
M-5904.....	E-129	M-649.....	E-131	M-7606.....	E-138
M-591.....	E-133	M-650.....	E-131	M-7607.....	E-138
M-5910.....	E-136	M-652.....	E-131	M-7608.....	E-138
M-592.....	E-133	M-653.....	E-131	M-7609.....	E-138
M-593.....	E-133	M-654.....	E-131	M-7610.....	E-138
M-5935.....	E-129	M-6552.....	E-125	M-7611.....	E-138
M-594.....	E-133	M-6630.....	E-128	M-7612.....	E-138
M-5940.....	E-129	M-6766.....	E-130	M-7613.....	E-138
M-5943.....	E-125	M-6906.....	E-128	M-7614.....	E-138
M-595.....	E-133	M70.....	H-73	M-7615.....	E-138
M-596.....	E-133	M-7075.....	E-131	M-7616.....	E-138
M-5961.....	E-129	M-7146.....	E-131	M-7617.....	E-138
M-5963.....	E-129	M-7192.....	E-132	M-7618.....	E-138
M-5972.....	E-129	M-7500.....	E-137	M-7619.....	E-138
M-598.....	E-133	M-7501.....	E-137	M-7620.....	E-139
M-599.....	E-133	M-7502.....	E-137	M-7621.....	E-139
M-5992.....	E-129	M-7503.....	E-137	M-7622.....	E-139
M60.....	H-73	M-7504.....	E-137	M-7623.....	E-139
M-600.....	E-133	M-7505.....	E-137	M-7624.....	E-139
M-6002.....	E-130	M-7506.....	E-137	M-7625.....	E-139
M-6003.....	E-129	M-7507.....	E-137	M-7626.....	E-139
M-602.....	E-132	M-7508.....	E-137	M-7627.....	E-139
M-6025.....	E-129	M-7509.....	E-137	M-7628.....	E-139
M-603.....	E-132	M-7510.....	E-137	M-7629.....	E-139
M-604.....	E-132	M-7511.....	E-137	M-7630.....	E-139
M-6046.....	E-125	M-7512.....	E-137	M-7631.....	E-139
M-6048.....	E-129	M-7513.....	E-137	M-7632.....	E-139
M-605.....	E-132	M-7514.....	E-137	M-7633.....	E-139
M-6051.....	E-130	M-7515.....	E-137	M-7634.....	E-139
M-6060.....	E-136	M-7520.....	E-137	M-7635.....	E-139
M-6061.....	E-136	M-7521.....	E-137	M-7636.....	E-139
M-6067.....	E-136	M-7522.....	E-137	M-7637.....	E-139
M-6072.....	E-136	M-7523.....	E-137	M-7638.....	E-139
M-6114.....	E-131	M-7528.....	E-137	M-7639.....	E-139
M-616.....	E-132	M-7529.....	E-137	M-7640.....	E-139

ALPHA-NUMERIC INDEX BY CATALOG NUMBER

M-7641.....	E-139	M-7888.....	E-141	M-8434.....	E-127
M-7642.....	E-139	M-7889.....	E-141	M-8435.....	E-127
M-7643.....	E-139	M-7890.....	E-141	M-8441.....	E-127
M-7644.....	E-139	M-7891.....	E-141	M-8442.....	E-127
M-7645.....	E-139	M-7892.....	E-141	M-8451.....	E-130
M-7646.....	E-139	M-7893.....	E-141	M-8452.....	E-127
M-7647.....	E-139	M-7894.....	E-141	M-8454.....	E-127
M-7648.....	E-139	M-7895.....	E-141	M-8461.....	E-130
M-7649.....	E-139	M-7896.....	E-141	M-8512.....	E-134
M-7650.....	E-139	M-7897.....	E-141	M-8718.....	E-134
M-7651.....	E-139	M-7898.....	E-141	M-8726.....	E-130
M-7652.....	E-139	M-7899.....	E-141	M-8802.....	E-130
M-7653.....	E-139	M-7900.....	E-141	M-8833.....	E-133
M-7654.....	E-139	M-7901.....	E-141	M-8882.....	E-125
M-7655.....	E-139	M-7902.....	E-141	M8ND.....	N-51
M-7656.....	E-139	M-7903.....	E-141	M90.....	H-73
M-7657.....	E-139	M-7904.....	E-141	M-9021.....	E-133
M-7658.....	E-139	M-7905.....	E-141	M-9029.....	E-134
M-7659.....	E-139	M-7906.....	E-141	M-9233.....	E-133
M-7708.....	E-140	M-7907.....	E-141	M-9233-S.....	E-133
M-7709.....	E-140	M-7908.....	E-141	M-9253.....	E-136
M-7710.....	E-140	M-7909.....	E-141	MCC1000.....	N-89
M-7711.....	E-140	M-7910.....	E-141	MCC1000BLADESET.....	N-89
M-7712.....	E-140	M-7911.....	E-141	MCC600.....	N-89
M-7713.....	E-140	M-7912.....	E-141	MCC600BLADESET.....	N-89
M-7714.....	E-140	M-7913.....	E-141	MD6.....	N-56
M-7715.....	E-140	M-7914.....	E-141	MD612.....	N-56
M-7716.....	E-140	M-7915.....	E-141	MD614.....	N-56
M-7717.....	E-140	M-7916.....	E-141	MD637.....	N-56
M-7718.....	E-140	M-7917.....	E-141	MD638.....	N-56
M-7719.....	E-140	M-7918.....	E-141	MD64.....	N-56
M-7720.....	E-140	M-7919.....	E-141	MD66.....	N-56
M-7721.....	E-140	M-7920.....	E-141	MD68.....	N-56
M-7722.....	E-140	M-7921.....	E-141	MD6CP1.....	N-102
M-7723.....	E-140	M-7922.....	E-141	MD7.....	N-57
M-7724.....	E-140	M-7923.....	E-141	MD734.....	N-58
M-7725.....	E-140	M80.....	H-73	MD734KIT1.....	N-58
M-7726.....	E-140	M-8011.....	E-130	MD734R.....	N-58
M-7727.....	E-140	M-8027.....	E-130	MD734RC.....	N-58
M-7728.....	E-140	M-8165.....	E-134	MD734RKIT1.....	N-58
M-7729.....	E-140	M-8214.....	E-130	MD76.....	N-57
M-7730.....	E-140	M-8294.....	E-130	MD78.....	N-57
M-7731.....	E-140	M-8359.....	E-136	MR15.....	N-46
M-7732.....	E-140	M-8379.....	E-132	MR15DIESETD1.....	N-46
M-7733.....	E-140	M-8381.....	E-132	MR18.....	N-46
M-7734.....	E-140	M-8402.....	E-126	MR18DIESETD1.....	N-46
M-7735.....	E-140	M-8403.....	E-126	MR20.....	N-46
M-7736.....	E-140	M-8410.....	E-132	MR20DIESETD1.....	N-46
M-7737.....	E-140	M-8413.....	E-132	MR4C.....	N-47
M-7738.....	E-140	M-8414.....	E-126	MR81A.....	N-44
M-7739.....	E-140	M-8415.....	E-126	MR833S1.....	N-44
M-7884.....	E-141	M-8422.....	E-126	MR89Q.....	N-44
M-7885.....	E-141	M-8423.....	E-132	MR8G96.....	N-44
M-7886.....	E-141	M-8426.....	E-126	MRC840.....	N-52
M-7887.....	E-141	M-8428.....	E-130	MRC840AL.....	N-52

ALPHA-NUMERIC INDEX BY CATALOG NUMBER

MRE1022B.....	N-45	NAH4444N.....	L-14	NDR65534T12.....	L-36
MRE1022NV.....	B-79, N-45	NAH4634N.....	L-14	NDR65544T12.....	L-36
MY28.....	N-53	NAH482N.....	L-14	NDR6748T12.....	L-36
MY284.....	N-53	NAH4834N.....	L-14	NDR67544T12.....	L-36
MY286.....	N-53	NAH4844N.....	L-14	NDR67548T12.....	L-36
MY2911.....	N-53	NAH4862N.....	L-14	NDR6844T12.....	L-36
MY2911C.....	N-53	NAH48634N.....	L-14	NDR6848T12.....	L-36
MY293.....	N-53	NAR25A2N.....	L-19	NFXR15.....	L-42
MY293C.....	N-53	NAR29A2N.....	L-19	NFXR15CG20.....	L-42
MY293CF.....	N-53	NAR29A4N.....	L-19	NFXR15CG24.....	L-42
MY29UNIVERSALKIT.....	N-53	NAR32A2N.....	L-19	NFXR15CG7.....	L-42
N2AH2934N.....	L-15	NAR32A4N.....	L-19	NHNT1429.....	L-26
N2AH342N.....	L-15	NAR36A2N.....	L-19	NHNT1434.....	L-26
N2AH3434N.....	L-15	NAR36A4N.....	L-19	NHNT1529.....	L-26
N2AH3444N.....	L-15	NAR42A2N.....	L-19	NHNT1534.....	L-26
N2AH4434N.....	L-15	NAR42A4N.....	L-19	NHNT1540.....	L-26
N2AH4444N.....	L-15	NAR45A2N.....	L-19	NHNT1629.....	L-26
N2AH4444NHQ.....	L-15	NAR45A4N.....	L-19	NHNT1634.....	L-26
N2AH4644N.....	L-15	NAR46A2N.....	L-19	NHNT1640.....	L-26
N2AH4844N.....	L-15	NAR46A4N.....	L-19	NHNT1644.....	L-26
NA122N.....	L-13	NAR48A2N.....	L-19	NHNT1729.....	L-26
NA132N.....	L-13	NAR48A4N.....	L-19	NHNT1734.....	L-26
NA142N.....	L-13	NAS292N.....	L-12	NHNT1740.....	L-26
NA144N.....	L-13	NAS2934N.....	L-12	NHNT1744.....	L-26
NA152N.....	L-13	NAS29N.....	L-12	NHNT1829.....	L-26
NA154N.....	L-13	NAS342N.....	L-12	NHNT1834.....	L-26
NA15A2N.....	L-21	NAS3434N.....	L-12	NHNT1840.....	L-26
NA15A4N.....	L-21	NAS34N.....	L-12	NHNT1844.....	L-26
NA164N.....	L-13	NAS40-2N.....	L-12	NHNT1846.....	L-26
NA16A2N.....	L-21	NAS4034N.....	L-12	NHNT1929.....	L-26
NA172N.....	L-13	NBC15A2N.....	L-20	NHNT1934.....	L-26
NA1744NHQ.....	L-13	NBC16A2N.....	L-20	NHNT1944.....	L-26
NA174N.....	L-13	NBC16A34N.....	L-20	NHNT1946.....	L-26
NA17A2N.....	L-21	NBC16A44N.....	L-20	NHNT2040.....	L-26
NA17A4N.....	L-21	NBC17A2N.....	L-20	NHNT2044.....	L-26
NA184N.....	L-13	NBC17A34N.....	L-20	NHNT2229.....	L-26
NA18A2N.....	L-21	NBC17A44N.....	L-20	NNT15A15A.....	L-28
NA18A4N.....	L-21	NBC18A2N.....	L-20	NNT16A16A.....	L-28
NA1944N.....	L-13	NBC18A34N.....	L-20	NNT17A17A.....	L-28
NA194N.....	L-13	NBC18A44N.....	L-20	NNT18A18A.....	L-28
NA194N90CG2.....	L-13	NBC19A34N.....	L-20	NNT20A20A.....	L-28
NA19A4N.....	L-21	NBC19A44N.....	L-20	NNT21A20A.....	L-28
NA20A4N.....	L-21	NBC20A34N.....	L-20	NNT22A22A.....	L-28
NA214N.....	L-13	NBC20A44N.....	L-20	NNTR15A36A.....	L-30
NA224N.....	L-13	NBC21A44N.....	L-20	NNTR15A42A.....	L-30
NA22A4N.....	L-21	NBC22A44N.....	L-20	NNTR16A29A.....	L-30
NAH292N.....	L-14	NBXR1534NHQ.....	L-11	NNTR16A32A.....	L-30
NAH2934N.....	L-14	NBXR1544NHQ.....	L-11	NNTR16A42A.....	L-30
NAH342N.....	L-14	NBXR15CG1.....	L-11	NNTR17A29A.....	L-30
NAH3434N.....	L-14	NDR6428T16.....	L-36	NNTR18A29A.....	L-30
NAH402N.....	L-14	NDR6434T16.....	L-36	NNTR19A42A.....	L-30
NAH4034N.....	L-14	NDR6534T12.....	L-36	NNTR20A32A.....	L-30
NAH4044N.....	L-14	NDR6534T14.....	L-36	NNTR22A46A.....	L-30
NAH442N.....	L-14	NDR6544T14.....	L-36	NNTR29A29A.....	L-29
NAH4434N.....	L-14	NDR65528T12.....	L-36	NNTR32A32A.....	L-29

ALPHA-NUMERIC INDEX BY CATALOG NUMBER

NNTR36A29A.....	L-29	NYT2825.....	K-46	OBDE-XL-17.9-19.0.....	J-42
NNTR36A36A.....	L-29	NYT2826.....	K-46	OBDE-XL-19.0-21.1.....	J-42
NNTR42A32A.....	L-29	NYT2828.....	K-46	OBDE-XL-21.1-22.1.....	J-42
NNTR42A36A.....	L-29	NYT282C.....	K-46	OEM175TFM.....	N-60
NNTR42A42A.....	L-29	NYT2925.....	K-46	OEM840NCP.....	N-59
NNTR45A45A.....	L-29	NYT2926.....	K-46	OH25.....	N-54
NNTR46A42A.....	L-29	NYT2928.....	K-46	OUR840.....	N-55
NNTR46A46A.....	L-29	NYT2929.....	K-46	OUR840WC.....	N-55
NNTR48A48A.....	L-29	NYT292C.....	K-46	P15K.....	N-5
NS1313.....	L-22	NYT3125.....	K-46	P8A.....	F-5
NS1414HC.....	L-22	NYT3126.....	K-46	PAT444SL5.....	N-16
NS14A14A.....	L-23	NYT3128.....	K-46	PAT444SL5PB.....	N-16
NS1515.....	L-22	NYT3129.....	K-46	PAT444SLI.....	N-16
NS1515HC.....	L-22	NYT3131.....	K-46	PAT444SLIPB.....	N-16
NS1515HCHO.....	L-22	NYT3426.....	K-46	PAT444ST3U03A2.....	N-7
NS15A15A.....	L-23	NYT3428.....	K-46	PAT444ST3U03A3.....	N-7
NS1616HC.....	L-22	NYT3429.....	K-46	PAT444ST3U05A2.....	N-7
NS1717.....	L-22	NYT3431.....	K-46	PAT444ST3U05A3.....	N-7
NS1717HCHO.....	L-22	NYT3434.....	K-46	PAT444SU03AA.....	N-12
NS17A17A.....	L-23	NYT3926.....	K-46	PAT444SU03AB.....	N-12
NS1818.....	L-22	NYT3928.....	K-46	PAT444SU03AC.....	N-12
NS18A18A.....	L-23	NYT3929.....	K-46	PAT444SU05AA.....	N-12
NS1919.....	L-22	NYT3931.....	K-46	PAT444SU05AB.....	N-12
NS1919HCHO.....	L-22	NYT3934.....	K-46	PAT444SU05AC.....	N-12
NS19A19A.....	L-23	NYT3939.....	K-46	PAT46CLWSL5.....	N-13
NS2121HC.....	L-22	NYT4426.....	K-46	PAT46CLWSL5PB.....	N-13
NS21A21A.....	L-23	NYT4428.....	K-46	PAT46CLWSLI.....	N-13
NS22A22A.....	L-23	NYT4429.....	K-46	PAT46CLWSLIPB.....	N-13
NS86A86A.....	L-23	NYT4431.....	K-46	PAT46LWL5.....	N-14
NSNT1329.....	L-25	NYT4434.....	K-46	PAT46LWL5PB.....	N-14
NSNT1429.....	L-25	NYT4439.....	K-46	PAT46LWLI.....	N-14
NSNT1434.....	L-25	NYT4444.....	K-46	PAT46LWLIIPB.....	N-14
NSNT1529.....	L-25	NYT4628.....	K-46	PAT46LWSL5.....	N-13
NSNT1629.....	L-25	NYT4629.....	K-46	PAT46LWSL5PB.....	N-13
NSNT2929.....	L-25	NYT4631.....	K-46	PAT46LWSLI.....	N-13
NSNT3429.....	L-25	NYT4634.....	K-46	PAT46LWSLIPB.....	N-13
NSNT3434.....	L-25	NYT4639.....	K-46	PAT46T3LU03A2.....	N-10
NSSBA350-750A.....	K-57	NYT4644.....	K-46	PAT46T3LU03A3.....	N-10
NSSBA4/0-500A.....	K-57	NYT4646.....	K-46	PAT46T3LU05A2.....	N-10
NSSBA500-1000A.....	K-57	OBDE10.7-11.5.....	J-41	PAT46T3LU05A3.....	N-10
NT1313.....	L-24	OBDE11.5-12.7.....	J-41	PAT46T3SC03A2.....	N-9
NT1414.....	L-24	OBDE12.7-13.7.....	J-41	PAT46T3SC03A3.....	N-9
NT1514.....	L-24	OBDE13.7-14.3.....	J-41	PAT46T3SC05A2.....	N-9
NT1515.....	L-24	OBDE14.3-14.8.....	J-41	PAT46T3SC05A3.....	N-9
NT1614.....	L-24	OBDE14.8-15.5.....	J-41	PAT46T3SU03A2.....	N-9
NT1616.....	L-24	OBDE15.5-16.2.....	J-41	PAT46T3SU03A3.....	N-9
NT1714.....	L-24	OBDE16.2-17.0.....	J-41	PAT46T3SU05A2.....	N-9
NT1717.....	L-24	OBDE17.0-17.9.....	J-41	PAT46T3SU05A3.....	N-9
NT1817.....	L-24	OBDE17.9-19.0.....	J-41	PAT4PC834L5.....	N-19
NT1919.....	L-24	OBDE8.98-9.75.....	J-41	PAT4PC834L5PB.....	N-19
NT2020.....	L-24	OBDE9.75-10.7.....	J-41	PAT4PC834LI.....	N-19
NT2121.....	L-24	OBDE-XL-14.8-15.5.....	J-42	PAT4PC834LIPB.....	N-19
NT2222.....	L-24	OBDE-XL-15.5-16.2.....	J-42	PAT500SJ66L5.....	N-21
NYFT3434CCP.....	K-39	OBDE-XL-16.2-17.0.....	J-42	PAT500SJ66LI.....	N-21
NYFT3434CCR.....	K-39	OBDE-XL-17.0-17.9.....	J-42	PAT500SJ68L5.....	N-21

ALPHA-NUMERIC INDEX BY CATALOG NUMBER

PAT500SJ68LI.....	N-21	PATCUT2156LIPB.....	N-74		
PAT500SJ68LICUTKIT1.....	N-21, N-77	PATCUT245L5.....	N-76	PATMD68LWJAW.....	N-21-22, N-77-82
PAT500SJ6L5.....	N-21	PATCUT245L5PB.....	N-76	PATMD68LWWCCJ.....	N-80
PAT500SJ6LI.....	N-21	PATCUT245LI.....	N-76	PATMD68LWWCJ.....	N-79
PAT500SJ6LICUTKIT1.....	N-21, N-77	PATCUT245LIPB.....	N-76	PATMD6LW.....	N-22
PAT500SJCUTL5.....	N-77	PATCUT4CUALLI.....	N-73	PATMD6LW5.....	N-22
PAT500SJCUTLI.....	N-77	PATCUT4L5.....	N-73	PATMD6LW5WCCJ.....	N-80
PAT600L5.....	N-20	PATMD10003AA.....	N-12	PATMD6LW5WCJ.....	N-79
PAT600L5PB.....	N-20	PATMD10003AB.....	N-12		N-21-22,
PAT600LI.....	N-20	PATMD10003AC.....	N-12	PATMD6LWJAW.....	N-77-82
PAT600LIPB.....	N-20	PATMD10005AA.....	N-12	PATMD6LWJWCVR.....	N-21, N-77
PAT644L5.....	N-17	PATMD10005AB.....	N-12	PATMD6LWWCCJ.....	N-80
PAT644L5PB.....	N-17	PATMD10005AC.....	N-12	PATMD6LWWCJ.....	N-79
PAT644LI.....	N-17	PATMD16003A1.....	N-81	PATMD70003A1.....	N-22
PAT644LIPB.....	N-17	PATMD16005A1.....	N-81	PATMD70005A1.....	N-22
PAT750CL5.....	N-15	PATMD20003AA.....	N-12	PATMD80003A1.....	N-22
PAT750CL5PB.....	N-15	PATMD20003AB.....	N-12	PATMD80005A1.....	N-22
PAT750CLI.....	N-15	PATMD20003AC.....	N-12	PATMDCUT82ALLIF.....	N-82
PAT750CLIPB.....	N-15	PATMD20005AA.....	N-12	PATMDCUTACSRKIT.....	N-78-79
PAT750L5.....	N-15	PATMD20005AB.....	N-12	PATMDCUTCLW.....	N-78
PAT750L5PB.....	N-15	PATMD20005AC.....	N-12	PATMDCUTCLW5.....	N-78
PAT750LI.....	N-15	PATMD26003A1.....	N-81		N-21-22, N-77-
PAT750LIPB.....	N-15	PATMD26005A1.....	N-81	PATMDCUTCLWJAW.....	80, N-82
PAT750T3C03A2.....	N-8	PATMD30003AA.....	N-12	PATMDCUTCUALKIT.....	N-78, N-80
PAT750T3C03A3.....	N-8	PATMD30003AB.....	N-12		N-21-22, N-77-
PAT750T3C05A2.....	N-8	PATMD30003AC.....	N-12	PATMDCUTGLWJAW.....	78, N-81-82
PAT750T3C05A3.....	N-8	PATMD30005AA.....	N-12	PATMDCUTGUYKIT.....	N-78, N-81
PAT750T3U03A2.....	N-8	PATMD30005AB.....	N-12	PATMDCUTLW.....	N-78
PAT750T3U03A3.....	N-8	PATMD30005AC.....	N-12	PATMDCUTLW5.....	N-78
PAT750T3U05A2.....	N-8	PATMD36003A1.....	N-81		N-21-22, N-77-
PAT750T3U05A3.....	N-8	PATMD36005A1.....	N-81	PATMDCUTLWJAW.....	79, N-82
PAT750U03AA.....	N-12		N-21-22,		N-21-22,
PAT750U03AB.....	N-12	PATMD430LWJAW.....	N-77-78	PATMDXPJLWJAW.....	N-77-78
PAT750U03AC.....	N-12	PATMD60003A1.....	N-78	PATPROBAG.....	N-5, N-104
PAT750U05AA.....	N-12	PATMD60005A1.....	N-78	PATRIOTKIT1.....	N-11
PAT750U05AB.....	N-12	PATMD6682ALLIF.....	N-82	PATRIOTKIT2.....	N-11
PAT750U05AC.....	N-12	PATMD6682ALLIFWCJ.....	N-82	PATRIOTKIT3.....	N-11
PAT81K2U03A2.....	N-18	PATMD66LW.....	N-22	PATRIOTKIT4.....	N-11
PAT81K2U03A3.....	N-18	PATMD66LW5.....	N-22	PENA1/2.....	F-5
PAT81K2U05A2.....	N-18	PATMD66LW5WCCJ.....	N-80	PENA134.....	F-5
PAT81K2U05A3.....	N-18	PATMD66LW5WCJ.....	N-79	PENA1355GAL.....	F-5
PATCASELI.....	N-5		N-21-22,	PENA135GAL.....	F-5
PATCHGRILI.....	N-5	PATMD66LWJAW.....	N-77-82	PENA138.....	F-5
PATCHGRILIDC.....	N-5	PATMD66LWJWCVR.....	N-21, N-77	PENA138BLB.....	F-5
PATCUT129L5.....	N-75	PATMD66LWWCCJ.....	N-80	PENA13CARTRIDGE.....	F-5
PATCUT129L5PB.....	N-75	PATMD66LWWCJ.....	N-79	PENA13GAL.....	F-5
PATCUT129LI.....	N-75	PATMD682ALLIF.....	N-82	PENA13QT.....	F-5
PATCUT129LIPB.....	N-75	PATMD682ALLIFWCJ.....	N-82	PENA4.....	F-5
PATCUT1500L5.....	N-83	PATMD6882ALLIF.....	N-82	PENA55GAL.....	F-5
PATCUT1500L5PB.....	N-83	PATMD6882ALLIFWCJ.....	N-82	PENA5GAL.....	F-5
PATCUT1500LI.....	N-83	PATMD68LW.....	N-22	PENA8BLB.....	F-5
PATCUT1500LIPB.....	N-83	PATMD68LW5.....	N-22	PENACARTRIDGE.....	F-5
PATCUT2156L5.....	N-74	PATMD68LW5WCCJ.....	N-80	PENAGAL.....	F-5
PATCUT2156L5PB.....	N-74	PATMD68LW5WCJ.....	N-79	PENAQT.....	F-5
PATCUT2156LI.....	N-74			PENE4.....	F-5

ALPHA-NUMERIC INDEX BY CATALOG NUMBER

PENE55GAL.....	F-5		N-30-33,	Q14F18X02D.....	B-61
PENE5GAL.....	F-5		N-35-37, N-86,	Q14F25X03B.....	B-61
PENE8.....	F-5	PT10054094.....	N-88	Q14F25X03D.....	B-61
PENE8BLB.....	F-5		N-5, N-21,	Q14M18X02B.....	B-61
PENEGAL.....	F-5	PT10074020.....	N-77	Q14M18X02D.....	B-61
PENEQT.....	F-5	PT10128.....	N-104	Q14M25X03B.....	B-61
PENHT1LB.....	F-5	PT11018.....	N-101	Q14M25X03D.....	B-61
PENHT4.....	F-5		N-5, N-73,	Q18F11X02D.....	B-61
PENHT8.....	F-5	PT208620.....	N-83	Q18F18X02B.....	B-61
PENHT8BLB.....	F-5	PT212851.....	N-28	Q18F18X02D.....	B-61
PENHTGAL.....	F-5	PT290741.....	N-101	Q18F25X03B.....	B-61
PG1025X03D.....	B-67	PT29091.....	N-101	Q18F25X03D.....	B-61
PG1211.....	N-47	PT292141.....	N-101, N-105	Q18M11X02D.....	B-61
PG1251.....	N-47	PT292792.....	N-24	Q18M18X02B.....	B-61
PG1331.....	N-47	PT29360.....	N-104	Q18M18X02D.....	B-61
PG1425X03D.....	B-67	PT294021.....	N-33, N-104	Q18M25X03B.....	B-61
PG1825X03D.....	B-67	PT29413.....	N-34	Q18M25X03D.....	B-61
PG3951.....	N-43	PT2972.....	N-24, N-104	Q2A1C2.....	A-18
PG3961.....	N-43	PT2990010.....	N-99	Q2A262N.....	A-18
PG3971.....	N-43	PT2990015.....	N-99	Q2A282N.....	A-18
PG3981.....	N-43	PT2990025.....	N-99	Q2A284N.....	A-18
PG4031R.....	N-45	PT2990110.....	N-99	Q2A312N.....	A-18
PG4032R.....	N-45	PT2990115.....	N-99	Q2A314N.....	A-18
PG4061.....	N-45	PT2990125.....	N-99	Q2A342N.....	A-18
PG4071.....	N-45	PT2990210.....	N-99	Q2A344N.....	A-18
PG4081.....	N-45	PT30250.....	N-39	Q2A402N.....	A-18
PGHS1425X03D.....	B-67	PT4583.....	N-55	Q2A404N.....	A-18
PGHS1825X03D.....	B-67	PT4925.....	N-58, N-102	Q2A444N.....	A-18
PGN1025X03B.....	B-68	PT49311.....	N-102	Q2A464N.....	A-18
PGN1025X03D.....	B-68	PT49521.....	N-58, N-102	Q2B282N.....	A-19
PGN1425X03B.....	B-68	PT50024605.....	N-59	Q2B312N.....	A-19
PGN1425X03D.....	B-68	PT50024683.....	N-59	Q2B404N.....	A-19
PGN1825X03B.....	B-68	PT50024685.....	N-59	Q3A282N.....	A-18
PGN1825X03D.....	B-68	PT6515.....	N-32	Q3A284N.....	A-18
PGP1025X03B.....	B-68	PT6545.....	N-32, N-104	Q3A312N.....	A-18
PGP1025X03D.....	B-68	PT6733.....	N-102	Q3A314N.....	A-18
PGP1425X03B.....	B-68	PT6744.....	N-102	Q3A342N.....	A-18
PGP1425X03D.....	B-68	PT76.....	N-100	Q3A344N.....	A-18
PGP1825X03B.....	B-68	PT8504.....	N-54	Q3A404N.....	A-18
PGP1825X03D.....	B-68	PT91.....	N-100	Q3A444N.....	A-18
PLB1425NN.....	E-111	PT93.....	N-101	Q3A464N.....	A-18
PLB1425NNH.....	E-111	PT94.....	N-101	QA1C2B.....	A-17
PPB1448NN.....	E-111	PT9711.....	N-94	QA1CB.....	A-17
PPB1448NNH.....	E-111	PTV10.....	B-71	QA262B.....	A-17
PT10024162.....	N-23, N-84, N-75, N-84,	PTV14.....	B-71	QA26B.....	A-17
		PTV18.....	B-71	QA282B.....	A-17
PT10037384.....	N-87, N-75, N-84,	PUADP1.....	N-5	QA282N.....	A-17
		Q10F11X02D.....	B-61	QA28B.....	A-17
PT10037388.....	N-87	Q10F18X02D.....	B-61	QA312B.....	A-17
PT10038657.....	N-76, N-88	Q10F25X03B.....	B-61	QA312N.....	A-17
PT10040663.....	N-76, N-88	Q10F25X03D.....	B-61	QA31B.....	A-17
PT10043890.....	N-87	Q10M25X03D.....	B-61	QA342B.....	A-17
PT10050733.....	N-26, N-27	Q14F11X02B.....	B-61	QA342N.....	A-17
		Q14F11X02D.....	B-61	QA344B.....	A-17
		Q14F18X02B.....	B-61	QA34B.....	A-17

ALPHA-NUMERIC INDEX BY CATALOG NUMBER

QA402N.....	A-17		A-10, E-64,	QP18F25X03D.....	B-62
QA40B.....	A-17	QGFL44BIT6.....	L-41	QP18M11X02D.....	B-62
QA442N.....	A-17	QGFL44G3.....	L-41	QP18M18X02B.....	B-62
QA444N.....	A-17		A-10, E-64,	QP18M18X02D.....	B-62
QA44B.....	A-17	QGFL46B1.....	L-41	QP18M25X03B.....	B-62
QA462N.....	A-17		A-10, E-64,	QP18M25X03D.....	B-62
QA46B.....	A-17	QGFL46BIT6.....	L-41	QPX2828.....	A-8, H-14
QA4C2B.....	A-17		A-10, E-64,	QPX2828Y.....	A-9
QA4CB.....	A-17	QGFL48B1.....	L-41	QPX282C.....	A-8, H-14
QA8C2B.....	A-17	QN10F18X02B.....	B-63	QPX282CY.....	A-9
QA8CB.....	A-17	QN10F18X02D.....	B-63	QPX2C2C.....	A-8, H-14
QB1C.....	A-19	QN10F25X03B.....	B-63	QPX2C2CY.....	A-9
QB26.....	A-19	QN10F25X03D.....	B-63	QPX3428.....	A-8, H-14
QB28.....	A-19	QN10M25X03D.....	B-63	QPX3428Y.....	A-9
QB312N.....	A-19	QN14F11X02B.....	B-63	QPX342C.....	A-8, H-14
QB4C.....	A-19	QN14F11X02D.....	B-63	QPX342CY.....	A-9
QB8C.....	A-19	QN14F18X02B.....	B-63	QPX3434.....	A-8, H-14
QDA1C.....	A-20	QN14F18X02D.....	B-63	QPX3434Y.....	A-9
QDA26.....	A-20	QN14F25X03B.....	B-63	QPX4428.....	A-8, H-14
QDA28.....	A-20	QN14F25X03D.....	B-63	QPX442C.....	A-8, H-14
QDA31.....	A-20	QN14M18X02B.....	B-63	QPX4434.....	A-8, H-14
QDA34.....	A-20	QN14M18X02D.....	B-63	QPX4444.....	A-8, H-14
QDA40.....	A-20	QN14M25X03B.....	B-63	QPX4444Y.....	A-9
QDA4C.....	A-20	QN14M25X03D.....	B-63	QQA1C.....	A-17
QDA8C.....	A-20	QN18F11X02B.....	B-63	QQA1C2.....	A-17
	A-10, E-64,	QN18F11X02D.....	B-63	QQA26.....	A-17
QGFL1CB1.....	L-41	QN18F18X02B.....	B-63	QQA262.....	A-17
	A-10, E-64,	QN18F18X02D.....	B-63	QQA28.....	A-17
QGFL1CBIT6.....	L-41	QN18F25X03B.....	B-63	QQA282N.....	A-17
	A-10, E-64,	QN18F25X03D.....	B-63	QQA31.....	A-17
QGFL26B1.....	L-41	QN18M18X02B.....	B-63	QQA312N.....	A-17
	A-10, E-64,	QN18M18X02D.....	B-63	QQA34.....	A-17
QGFL26BIT6.....	L-41	QN18M25X03B.....	B-63	QQA342N.....	A-17
	A-10, E-64,	QN18M25X03D.....	B-63	QQA402N.....	A-17
QGFL26B2.....	L-41	QP10F18X02B.....	B-62	QQA442N.....	A-17
	A-10, E-64,	QP10F18X02D.....	B-62	QQA444N.....	A-17
QGFL26B2T6.....	L-41	QP10F25X03B.....	B-62	QQA4C2.....	A-17
	A-10, E-64,	QP10F25X03D.....	B-62	QQA8C.....	A-17
QGFL29B1.....	L-41	QP10F38X05D.....	B-62	QR1C.....	A-20
	A-10, E-64,	QP10M25X03D.....	B-62	QR26.....	A-20
QGFL29BIT6.....	L-41	QP14F11X02D.....	B-62	QR28.....	A-20
	A-10, E-64,	QP14F18X02B.....	B-62	QR31.....	A-20
QGFL31B1.....	L-41	QP14F18X02D.....	B-62	QR34.....	A-20
	A-10, E-64,	QP14F25X03.....	B-78	QR40.....	A-20
QGFL31BIT6.....	L-41	QP14F25X03B.....	B-62	QR4C.....	A-20
	A-10, E-64,	QP14F25X03D.....	B-62	RA6UCRSL.....	K-49
QGFL34B1.....	L-41	QP14M11X02D.....	B-62	RA6UCSL.....	K-49
	A-10, E-64,	QP14M18X02B.....	B-62	RCC1000.....	N-90
QGFL34BIT6.....	L-41	QP14M18X02D.....	B-62	RCC336.....	N-91
	A-10, E-64,	QP14M25X03B.....	B-62	RCC556.....	N-91
QGFL39B1.....	L-41	QP14M25X03D.....	B-62	RCC600E.....	N-90
	A-10, E-64,	QP18F11X02D.....	B-62	RCC750HD.....	N-90
QGFL39BIT6.....	L-41	QP18F18X02B.....	B-62	RCC954ACSR1K.....	N-91
	A-10, E-64,	QP18F18X02D.....	B-62	RDM428.....	K-49
QGFL44B1.....	L-41	QP18F25X03B.....	B-62	RDM628.....	K-49

ALPHA-NUMERIC INDEX BY CATALOG NUMBER

RDM828.....	K-49	S2GBP45A12.....	I-26	SFD72AD20.....	L-39
RDMD42858D.....	K-49	S2GBP46A.....	I-27	SH2GBP41A5.....	I-26
RGC39G1.....	E-65	S2GBP46A12.....	I-27	SH2GBP41A512.....	I-26
RGC44G1.....	E-65	S2GBP483A.....	I-27	SH2GBP445A5.....	I-26
RHCC129ACSR.....	N-87	S2GBP483A12.....	I-27	SH2GBP445A512.....	I-26
RHCC2156ACSR.....	N-86	S2GBP486A.....	I-27	SH2GBP44A5.....	I-26
RHCC2156ACSRF.....	N-86	S2GBP486A12.....	I-27	SH2GBP44A512.....	I-26
RHCC245CUAL.....	N-88	S2GBP48A.....	I-27	SH2GBP45A5.....	I-26
RHCC4CUAL.....	N-85	S2GBP48A12.....	I-27	SH2GBP45A512.....	I-26
RHCC4CUALBLD.....	N-85	S2GBPA41A.....	I-26	SH2GBP46A5.....	I-27
RHCC4CUALGDEBLD.....	N-85	S2GBPA41A12.....	I-26	SH2GBP46A512.....	I-27
RK1412.....	B-81	S2GBPA445A.....	I-26	SH2GBP483A5.....	I-27
RK1422.....	B-81	S2GBPA445A12.....	I-26	SH2GBP483A512.....	I-27
RK1942.....	F-14, N-106	S2GBPA44A.....	I-26	SH2GBP486A5.....	I-27
RPC701302.....	N-90	S2GBPA44A12.....	I-26	SH2GBP486A512.....	I-27
RPC701402.....	N-90	S2GBPA45A.....	I-26	SH2GBP48A5.....	I-27
RPC705501.....	N-91	S2GBPA45A12.....	I-26	SH2GBP48A512.....	I-27
RPC705601.....	N-91	S2GBPA46A.....	I-27	SN10.....	B-52
RPC902101.....	N-91	S2GBPA46A12.....	I-27	SN10B.....	B-53
RPC902201.....	N-91	S2GBPA483A.....	I-27	SN14.....	B-52
RWRC516.....	N-92	S2GBPA483A12.....	I-27	SN14B.....	B-53
RWRC916.....	N-92	S2GBPA486A.....	I-27	SN18.....	B-52
RYA25UC.....	K-50	S2GBPA486A12.....	I-27	SN18B.....	B-53
RYA25UCR.....	K-50	S2GBPA48A.....	I-27	SP10.....	B-51
RYA26UC.....	K-50	S2GBPA48A12.....	I-27	SP14.....	B-51
RYA26UCR.....	K-50	S2GGBP486A9.....	L-40	SP16.....	B-51
RYA27UC.....	K-50	S3000.....	J-39	SP18.....	B-78
RYA27UCR.....	K-50	S3GBP41A.....	I-28	SPB1426NN.....	E-111
RYA28UC.....	K-50	S3GBP445A.....	I-28	SPB1426NNH.....	E-111
RYA28UCR.....	K-50	S3GBP44A.....	I-28	SPB1449NN.....	E-111
RYA29UC.....	K-50	S3GBP45A.....	I-28	SPB1449NNH.....	E-111
RYA29UCR.....	K-50	S3GBP46A.....	I-28	SPRING CFS1005.1.03".....	D-9
RYA2UC.....	K-50	S3GBP483A.....	I-28	SPRING-CFS0405 .47".....	D-9
RYA2UCR.....	K-50	S3GBP486A.....	I-28	SPRING-CFS0605 .56".....	D-9
RYA2WAC.....	K-50	S3GBP48A.....	I-28	STKIT08.....	B-78
RYA2WACR.....	K-50	S4000.....	J-39	STKIT15.....	B-78
RYA31AC.....	K-50	S500.....	J-39	STKIT1602MRE1022NV.....	B-79
RYA31ACR.....	K-50	S750.....	J-39	STS44A4NCG2.....	I-25, L-21, M-21
RYA4UC.....	K-50	SB232TC14.....	E-62	STS44ACG10.....	I-25, L-21, M-21
RYA4UCR.....	K-50	SB232TC38.....	E-62	STS46A6NCG1.....	I-25, L-21, M-21
RYA75AC.....	K-50	SB23U.....	E-62	SW2A444A44N90.....	M-9
RYA75ACR.....	K-50	SB252TC14.....	E-62	SW2A486A44N.....	M-9
RYAC25.....	K-50-51	SB252TC38.....	E-62	SW2A486A44N90.....	M-9
RYAC31.....	K-50-51	SB25U.....	E-62	SW2A486A66N90.....	M-9
RYAC311.....	K-51	SBDE410.....	J-40	SW2A48A44N.....	M-9
S1000.....	J-39	SBDE440.....	J-40	SW2A58R44N.....	M-9
S1500.....	J-39	SBDE556.5-2.....	J-40	SWA18A34N.....	M-10
S2000.....	J-39	SC2.....	A-3, H-5	SWA18A44N.....	M-10
S2GBP41A.....	I-26	SC2/0.....	A-3, H-5	SWA19A34N.....	M-10
S2GBP41A12.....	I-26	SC4.....	A-3, H-5	SWA19A44N.....	M-10
S2GBP445A.....	I-26	SCB22A.....	M-22	SWA20A2N.....	M-10
S2GBP445A12.....	I-26	SCB24A.....	M-22	SWA20A34N.....	M-10
S2GBP44A.....	I-26	SFD67D12.....	L-39	SWA20A44N.....	M-10
S2GBP44A12.....	I-26	SFD70AD16.....	L-39	SWA21A44N.....	M-10
S2GBP45A.....	I-26	SFD71AD16.....	L-39	SWA22A44N.....	M-10

ALPHA-NUMERIC INDEX BY CATALOG NUMBER

SWA23A44N	M-10	SWL19A.....	M-20	T1016.....	B-5
SWA24A44N	M-10	SWL21A.....	M-20	T1038.....	B-5
SWA444A44N	M-8	SWL22A.....	M-20	T106.....	B-5
SWA486A44N	M-8	SWL58A.....	M-20	T106F.....	B-29
SWA58R44N	M-8	SWL59A.....	M-20	T106LF.....	B-35
SWA86A44N	M-10	SWL86A.....	M-20	T108.....	B-5
SWA90A44N	M-10	SWL90A.....	M-20	T108F.....	B-29
SWA92A44N	M-10	SWL91A.....	M-20	T108LF.....	B-35
SWAB19A2N	M-13	SWL92A.....	M-20	T1410.....	B-5
SWAB19A34N	M-13	SWL93A.....	M-20	T1410F.....	B-29
SWAB22A2N.....	M-13	SWL96A.....	M-20	T1410LF.....	B-35
SWAB22A34N.....	M-13	SWOH18A5.....	M-17	T1414.....	B-5
SWAB22A44N.....	M-13	SWOH19A3.....	M-17	T1414F.....	B-29
SWAB86A34N.....	M-13	SWOH19A5.....	M-17	T1438.....	B-5
SWAB86A44N.....	M-13	SWOH20A5.....	M-17	T144.....	B-5
SWAC18A2N.....	M-11	SWOH24A5.....	M-17	T14516.....	B-5
SWAC18A34N.....	M-11	SWT17A17A.....	M-14	T146.....	B-5
SWAC18A44N.....	M-11	SWT18A16A75.....	M-15	T146F.....	B-29
SWAC19A2N.....	M-11	SWT19A17A75.....	M-15	T146LF.....	B-35
SWAC19A34N.....	M-11	SWT19A18A75.....	M-15	T148.....	B-5
SWAC19A44N.....	M-11	SWT19A19A.....	M-14	T148F.....	B-29
SWAC20A34N.....	M-11	SWT20A18A75.....	M-15	T148LF.....	B-35
SWAC20A44N.....	M-11	SWT21A16A75.....	M-15	T1610LF.....	B-35
SWAC21A34N.....	M-11	SWT21A17A.....	M-14	T166LF.....	B-35
SWAC21A44N.....	M-11	SWT21A18A.....	M-14	T168LF.....	B-35
SWAC22A44N.....	M-11	SWT21A18A75.....	M-15	T1810.....	B-5
SWAC23A34N.....	M-11	SWT21A19A75.....	M-15	T1810F.....	B-29
SWAC24A44N.....	M-11	SWT21A20A.....	M-14	T1814.....	B-5
SWAC86A44N.....	M-11	SWT22A18A.....	M-14	T1814F.....	B-29
SWAC92A44N.....	M-11	SWT22A18A75.....	M-15	T1838.....	B-5
SWAC94A44N.....	M-11	SWT22A19A75.....	M-15	T184.....	B-5
SWAC96A44N.....	M-11	SWT22A20A.....	M-14	T18516.....	B-5
SWAT18A16A30.....	M-16	SWT22A20A75.....	M-15	T186.....	B-5
SWAT18A17A30.....	M-16	SWT22A21A.....	M-14	T186F.....	B-29
SWAT18A18A30.....	M-16	SWT22A22A.....	M-14	T188.....	B-5
SWAT19A16A30.....	M-16	SWT24A18A75.....	M-15	T188F.....	B-29
SWAT19A17A30.....	M-16	SWT24A19A75.....	M-15	TCB14212P.....	E-109
SWAT20A17A30.....	M-16	SWT24A20A.....	M-14	TCB14212PK.....	E-109
SWAT20A18A30.....	M-16	SWT24A20A75.....	M-15	TCB14212SK.....	E-104
SWAT20A19A30.....	M-16	SWT24A21A.....	M-14	TCB14412J.....	E-108
SWAT21A18A30.....	M-16	SWT24A24A.....	M-14	TCB14412JK.....	E-108
SWAT21A19A30.....	M-16	SWT86A20A.....	M-14	TCB14412M.....	E-108
SWAT22A18A30.....	M-16	SWT86A20A75.....	M-15	TCB14412MK.....	E-108
SWAT22A19A30.....	M-16	SWT86A21A75.....	M-15	TCB14420J.....	E-108
SWAT22A20A30.....	M-16	SWT86A22A75.....	M-15	TCB14420JK.....	E-108
SWAT24A19A30.....	M-16	SWT86A24A.....	M-14	TCB14420M.....	E-108
SWAT24A20A30.....	M-16	SWXHP22A5.....	M-19	TCB14420MK.....	E-108
SWAT86A20A30.....	M-16	SWXHP24A5.....	M-19	TCB14424J.....	E-108
SWAT86A21A30.....	M-16	SWXHP86A5.....	M-19	TCB14424JK.....	E-108
SWAT86A22A30.....	M-16	T1010.....	B-5	TCB14424M.....	E-108
SWHRH19A3CH.....	M-18	T1010F.....	B-29	TCB14424MK.....	E-108
SWHRH20A3CH.....	M-18	T1010LF.....	B-35	TFV3B12V2.....	G-21
SWHRH22A5CH.....	M-18	T1012.....	B-5	TFV3B18V2.....	G-21
SWHRH86A5CH.....	M-18	T1014.....	B-5	TFV3B6V2.....	G-21
SWL18A.....	M-20	T1014F.....	B-29	TFV3BLU12.....	G-21

ALPHA-NUMERIC INDEX BY CATALOG NUMBER

TFV3BLU18.....	G-21	TN1410LF.....	B-37	TP108F.....	B-31
TMH261.....	F-12	TN1414.....	B-9	TP108LF.....	B-36
TMH261SS.....	F-12	TN1414F.....	B-32	TP108Z.....	B-45
TMH262.....	F-12	TN1438.....	B-9	TP1410.....	B-8
TMH262SS.....	F-12	TN144.....	B-9	TP1410BF.....	B-40
TMH263.....	F-12	TN14516.....	B-9	TP1410F.....	B-31
TMH263SS.....	F-12	TN146.....	B-9	TP1410LF.....	B-36
TMH264.....	F-12	TN146BF.....	B-41	TP1410Z.....	B-45
TMH264SS.....	F-12	TN146F.....	B-32	TP1414.....	B-8
TMH265.....	F-12	TN146G1.....	B-9	TP142F.....	B-31
TMH265SS.....	F-12	TN146LF.....	B-37	TP142Z.....	B-45
TMH266.....	F-12	TN148.....	B-9	TP1438.....	B-8
TMH267.....	F-12	TN148BF.....	B-41	TP144.....	B-8
TMH267SS.....	F-12	TN148F.....	B-32	TP14516.....	B-8
TMH268.....	F-12	TN148LF.....	B-37	TP146.....	B-8
TMH268SS.....	F-12	TN1810.....	B-9	TP146BF.....	B-40
TMH269.....	F-12	TN1810BF.....	B-41	TP146F.....	B-31
TMH269SS.....	F-12	TN1810F.....	B-32	TP146LF.....	B-36
TMH270.....	F-12	TN1810LF.....	B-37	TP146Z.....	B-45
TMH270SS.....	F-12	TN1814.....	B-9	TP148.....	B-8
TMH271.....	F-12	TN1814F.....	B-32	TP148BF.....	B-40
TMH271SS.....	F-12	TN1838.....	B-9	TP148F.....	B-31
TMH272.....	F-12	TN184.....	B-9	TP148LF.....	B-36
TMH272SS.....	F-12	TN184F.....	B-32	TP148Z.....	B-45
TMH289.....	F-12	TN18516.....	B-9	TP1610.....	B-8
TMH294.....	F-12	TN186.....	B-9	TP1610BF.....	B-40
TMH294SS.....	F-12	TN186BF.....	B-41	TP1610F.....	B-31
TMH295.....	F-12	TN186F.....	B-32	TP1610LF.....	B-36
TMH295SS.....	F-12	TN186G1.....	B-9	TP1610Z.....	B-45
TMH322SS.....	F-12	TN186LF.....	B-37	TP1614.....	B-8
TMH332.....	F-12	TN188.....	B-9	TP162F.....	B-31
TMH69.....	F-12	TN188BF.....	B-41	TP162Z.....	B-45
TMH69SS.....	F-12	TN188F.....	B-32	TP1638.....	B-8
TMHG42.....	E-23	TN188LF.....	B-37	TP164.....	B-8
TMHG92.....	E-23	TN202F.....	B-32	TP16516.....	B-8
TN1010.....	B-9	TN206F.....	B-32	TP166.....	B-8
TN1010BF.....	B-41	TOOLBAGMDLI.....	N-5, N-22, N-78-81	TP166BF.....	B-40
TN1010F.....	B-32	TP100.....	J-28	TP166F.....	B-31
TN1010LF.....	B-37	TP1010.....	B-8	TP166LF.....	B-36
TN1012.....	B-9	TP1010BF.....	B-40	TP166Z.....	B-45
TN1014.....	B-9	TP1010F.....	B-31	TP168.....	B-8
TN1014F.....	B-32	TP1010LF.....	B-36	TP168BF.....	B-40
TN1038.....	B-9	TP1010Z.....	B-45	TP168F.....	B-31
TN10516.....	B-9	TP1012.....	B-8	TP168LF.....	B-36
TN106.....	B-9	TP1014.....	B-8	TP168Z.....	B-45
TN106BF.....	B-41	TP1038.....	B-8	TP200.....	J-28
TN106F.....	B-32	TP10516.....	B-8	TP300.....	J-28
TN106LF.....	B-37	TP106.....	B-8	TP400.....	J-28
TN108.....	B-9	TP106BF.....	B-40	TTV10.....	B-70
TN108BF.....	B-41	TP106F.....	B-31	TTV14.....	B-70
TN108F.....	B-32	TP106LF.....	B-36	TTV18.....	B-70
TN108LF.....	B-37	TP106Z.....	B-45	TW115EZ.....	E-118
TN1410.....	B-9	TP108.....	B-8	TW150EZ.....	E-118
TN1410BF.....	B-41	TP108BF.....	B-40	TW15EZ.....	E-118
TN1410F.....	B-32			TW200EZ.....	E-118

ALPHA-NUMERIC INDEX BY CATALOG NUMBER

TW250EZ.....	E-118	UC28R.....	H-16	UHG15A3CH.....	L-33
TW25EZ.....	E-118	UC28RS.....	H-16	UHG15A5CH.....	L-33
TW32EZ.....	E-118	UC2W28L.....	H-10	UHG16A3CH.....	L-33
TW45EZ.....	E-118	UC2W30.....	H-13	UHG17A3.....	L-33
TW500EZ.....	E-118	UC3040.....	H-13	UHG17A3CH.....	L-33
TW65EZ.....	E-118	UC32R.....	H-16	UHG17A5.....	L-33
TW90EZ.....	E-118	UC32RS.....	H-16	UHG17A5CH.....	L-33
U1CART.....	N-68-69	UC33R.....	H-16	UHG18A3.....	L-33
U1CRT1.....	N-68-69	UC3444.....	H-13	UHG18A3CH.....	L-33
U1CRT1W.....	N-68	UC4W28.....	H-13	UHG18A5.....	L-33
U25ART.....	N-68-69	UC4W28CONKIT.....	H-19	UHG18A5CH.....	L-33
U25RT.....	N-68-69	UC6W25.....	H-13	UHG19A3.....	L-33
U25RTW.....	N-68	UC6W25CONKIT.....	H-19	UHG20A3CH.....	L-33
U26ART.....	N-68-69	UC8W26L.....	H-10	UHG20A5.....	L-33
U26RT.....	N-68-69	UCCOVER1BOX25.....	H-19	UHG20A5CH.....	L-33
U26RTW.....	N-68	UCG25R.....	H-16	UHG21A3.....	L-33
U27ART.....	N-68-69	UCG25R2R.....	H-16	UHG22A3CH.....	L-33
U27RT.....	N-68-69	UCG25R2RS.....	H-16	UHG22A5.....	L-33
U27RTW.....	N-68	UCG25RS.....	H-16	UHG22A5CH.....	L-33
U28ART.....	N-68-69	UCG28R.....	H-16	UHG24A3.....	L-33
U28RT.....	N-68-69	UCG28RS.....	H-16	UHG24A3CH.....	L-33
U28RTW.....	N-68	UCG32R.....	H-16	UHG24A5.....	L-33
U29ART.....	N-68-69	UCG32RS.....	H-16	UHG24A5CH.....	L-33
U29RT.....	N-68-69	UCK1UL.....	H-10	UHG83A5.....	L-33
U2CABT.....	N-68-69	UCK2UL.....	H-10	UHG86A5CH.....	L-33
U2CRT.....	N-68-69	UCK3UL.....	H-10	UHKR11A3.....	L-34
U2CRTW.....	N-68	UCT26.....	H-18	UHKR11A5.....	L-34
U30ART.....	N-68-69	UCT26RS.....	H-17	UHKR13A3.....	L-34
U30RT.....	N-68-69	UCT32.....	H-18	UHKR13A5.....	L-34
U31ART.....	N-68-69	UCT32RS.....	H-17	UHKR14A3.....	L-34
U31RT.....	N-68-69	UCT41R28RS.....	H-17	UHKR14A5.....	L-34
U32ART.....	N-68-69	UCT41R41RS.....	H-17	UHKR16A3.....	L-34
U32RT.....	N-68-69	UCTCOVER.....	H-19	UHKR16A5.....	L-34
U34ART.....	N-68-69	UCU28AC.....	A-36	UHKR17A5.....	L-34
U34RT.....	N-68-69	UDIEKITAL.....	N-69	UHR133.....	L-31
U36ART.....	N-68-69	UDIEKITCU.....	N-69	UHR135.....	L-31
U36RT.....	N-68-69	UDIEKITHYGRD.....	N-69	UHR153.....	L-31
U38XRT.....	N-68	UGS350ULDB.....	A-38	UHR175.....	L-31
U39ART2.....	N-68-69	UGSKIT2.....	A-37	UM25N.....	N-59, N-70
U39RT.....	N-68-69	UGSKIT250.....	A-37	UM26N.....	N-59, N-70
U3CRT.....	N-68	UGSKIT8.....	A-38	UM27N.....	N-59, N-70
U3CRTW.....	N-68	UH143.....	L-31	UM28N.....	N-59, N-70
U44XRT.....	N-68	UH153.....	L-31	UM2CN.....	N-59, N-70
U4CABT.....	N-68-69	UH163.....	L-31	UM30N.....	N-70
U4CRT.....	N-68-69	UH165.....	L-31	UM31N.....	N-70
U4CRTW.....	N-68	UH173.....	L-31	UM33N.....	N-70
U5CRT.....	N-68-69	UH175.....	L-31	UM36N.....	N-70
U5CRTW.....	N-68	UH183.....	L-31	UM4CN.....	N-59, N-70
U6CABT.....	N-68-69	UH193.....	L-31	UM6CN.....	N-59, N-70
U8CABT.....	N-68	UH195.....	L-31	UM8CN.....	N-59, N-70
U8CRT.....	N-68	UH205.....	L-31	UMA.....	N-59, N-70
U8CRTW.....	N-68	UH225.....	L-31	UMB.....	N-59, N-70
UC25R2R.....	H-16	UHG14A3.....	L-33	UMC.....	N-59, N-70
UC25R2RS.....	H-16	UHG14A3CH.....	L-33	UMDIEKIT.....	N-70
UC2834.....	H-13	UHG15A3.....	L-33	UME.....	N-70

ALPHA-NUMERIC INDEX BY CATALOG NUMBER

UP34R.....	H-72	VV3A46CG3.....	L-18	W30VT.....	N-71
UP45R.....	H-72	VV3D6846R12.....	L-38	W31ART.....	N-71-72
UP45R36R.....	H-72	VV3D7046R12.....	L-38	W31RT.....	N-71-72
	E-6-8, E-10,	VV3D7246R12.....	L-38	W31VT.....	N-71
UPRECRIMP12.....	E-12, E-15	VVA25.....	A-21, L-16	W32RT.....	N-71
	E-6-8, E-10,	VVA28.....	A-21, L-16	W32VT.....	N-71
UPRECRIMP34.....	E-12, E-15	VVA282N.....	A-21, L-16	W33RT.....	N-71
	E-6-8, E-10,	VVA2C.....	A-21	W33VT.....	N-71
UPRECRIMP58.....	E-12, E-15-16	VVA30.....	A-21	W34RT.....	N-71-72
UW25R.....	H-12	VVA302N.....	A-21, L-16	W34VT.....	N-71
UW2R.....	H-12	VVA34.....	A-21, L-16	W36RT.....	N-71
VA25.....	A-21	VVA342N.....	A-21, L-16	W3CRT.....	N-71
VA28.....	A-21	VVA344N.....	A-21, L-16	W4CRT.....	N-71-72
VA282N.....	A-21	VVA40.....	A-21, L-16	W4CVT.....	N-71
VA2C.....	A-21	VVA402N.....	A-21, L-16	W5CRT.....	N-71-72
VA30.....	A-21	VVA404N.....	A-21, L-16	W5CVT.....	N-71
VA302N.....	A-21	VVA404NCG1.....	L-16	W660.....	N-71-72
VA34.....	A-21	VVA442N.....	L-16	W687.....	N-103
VA342N.....	A-21	VVA444N.....	L-16	W702.....	N-103
VA344N.....	A-21	VVA462N.....	L-16	W8CRT.....	N-71-72
VA40.....	A-21	VVA464NCG2.....	L-16	W8CVT.....	N-71
VA402N.....	A-21	VVA464NCG4.....	L-16	WABAG.....	J-15, N-109
VA404N.....	A-21	VYFT3428CCP.....	K-39	WAD1015.....	J-16
VG1.....	H-9	VYFT3428CCR.....	K-39	WAD1029.....	J-16
VG2.....	H-9	VYFT3434CCP.....	K-39	WAD1035.....	J-16
VG3.....	H-9	VYFT3434CCR.....	K-39	WAD33615.....	J-16
VG4.....	H-9	VYFT3934CCP.....	K-39	WAD33629.....	J-16
VG5.....	H-9	VYFT3934CCR.....	K-39	WAD33635.....	J-16
VP2828.....	H-12	VYFT4434CCP.....	K-39	WAD4015.....	J-16
VP3030.....	H-12	VYFT4434CCR.....	K-39	WAD4029.....	J-16
VP3430.....	H-12	W161.....	N-71-72	WAD4035.....	J-16
VP3434.....	H-12	W162.....	N-71-72	WAD47715.....	J-16
VP4030.....	H-12	W163.....	N-71-72	WAD47729.....	J-16
VP4440.....	H-12	W166.....	N-71-72	WAD47735.....	J-16
VP4646.....	H-12	W1CRT1.....	N-71-72	WAD55615.....	J-16
VT2525.....	H-15, L-27	W1CVT.....	N-71	WAD55629.....	J-16
VT2825.....	H-15, L-27	W239.....	N-71-72	WAD55635.....	J-16
VT2828.....	H-15, L-27	W241.....	N-71-72	WAD79515.....	J-16
VT2C2C.....	H-15, L-27	W245.....	N-71-72	WAD79529.....	J-16
VT3025.....	H-15	W249.....	N-71-72	WAD79535.....	J-16
VT3030.....	H-15	W25RT.....	N-71-72	WADM33615.....	J-17
VT3425.....	H-15	W25VT.....	N-71	WADM33629.....	J-17
VT3428.....	H-15	W26RT.....	N-71-72	WADM33635.....	J-17
VT3430.....	H-15	W26VT.....	N-71	WADM336CON.....	J-17
VT3434.....	H-15	W27RT.....	N-71-72	WADM55615.....	J-17
VT4040.....	H-15	W27VT.....	N-71	WADM55629.....	J-17
VT4425.....	H-15	W28K.....	N-103	WADM55635.....	J-17
VT4428.....	H-15	W28K.....	N-5	WADM556CON.....	J-17
VT4434.....	L-27	W28RT.....	N-71-72	WADM79515.....	J-17
VT4834.....	H-15	W28VT.....	N-71	WADM79529.....	J-17
VV2A34CG1.....	L-17	W29RT.....	N-71-72	WADM79535.....	J-17
VV2A4044N.....	L-17	W29VT.....	N-71	WADM795CON.....	J-17
VV2A46CG1.....	L-17	W2CRT.....	N-71-72	WBG.....	N-103
VV3A46CG1.....	L-18	W2CVT.....	N-71	WBS10V.....	E-153, G-25
VV3A46CG2.....	L-18	W30RT.....	N-71	WBS12V.....	E-153, G-25

ALPHA-NUMERIC INDEX BY CATALOG NUMBER

WBS14V.....	E-153, G-25	WCCB.....	J-5	WCY133.....	J-8
WBS20V.....	E-153, G-25	WCCLY.....	J-5	WCY134.....	J-8
WBS24V.....	E-153, G-25	WCCR.....	J-5	WCY135.....	J-8
WBS30V.....	E-153, G-25	WCCSY.....	J-5	WCY136.....	J-8
WBS36V.....	E-153, G-25	WCH1.....	E-155, G-26	WCY137.....	J-8
WBS8V.....	E-153, G-25	WCH1GS.....	E-155, G-26	WCY138.....	J-8
WCAB30R2N.....	J-13	WCH2.....	E-155, G-26	WCY139.....	J-8
WCAB30R4N.....	J-13	WCH2B10.....	E-155, G-26	WCY140.....	J-8
WCAY39R2N.....	J-13	WCH2B10GS.....	E-155, G-26	WCY145.....	J-8
WCAY39R4N.....	J-13	WCH2GS.....	E-155, G-26	WCY48.....	J-6
WCAY49R2N.....	J-13	WCH2H1090.....	E-155, G-26	WCY49.....	J-6
WCAY49R4N.....	J-13	WCH2H1090GS.....	E-155, G-26	WCY50.....	J-6
WCB10.....	J-6	WCHAWAS.....	J-14, N-110	WCY51.....	J-6
WCB10C2.....	J-9-10	WCR29.....	J-6	WCY52.....	J-6
WCB11.....	J-6	WCR30.....	J-6	WCY53.....	J-7
WCB11PB.....	J-13	WCR31.....	J-6	WCY53PB.....	J-13
WCB12.....	J-6	WCR32.....	J-6	WCY54.....	J-7
WCB13.....	J-6	WCR33.....	J-6	WCY54PB.....	J-13
WCB14.....	J-6	WCR34.....	J-6	WCY55.....	J-7
WCB15.....	J-6	WCR35.....	J-6	WCY56.....	J-7
WCB16.....	J-6	WCR36.....	J-6	WCY57.....	J-7
WCB17.....	J-6	WCR37.....	J-6	WCY58.....	J-7
WCB18.....	J-6	WCY100.....	J-7	WCY59.....	J-7
WCB19.....	J-6	WCY101.....	J-8	WCY60.....	J-7
WCB20.....	J-6	WCY102.....	J-8	WCY61.....	J-7
WCB20C2.....	J-9-10	WCY103.....	J-8	WCY62.....	J-7
WCB20C20.....	J-9-10	WCY104.....	J-8	WCY63.....	J-7
WCB21.....	J-6	WCY105.....	J-8	WCY63PB.....	J-13
WCB22.....	J-6	WCY106.....	J-8	WCY64.....	J-7
WCB23.....	J-6	WCY107.....	J-8	WCY64PB.....	J-13
WCB24.....	J-6	WCY108.....	J-8	WCY65.....	J-7
WCB25.....	J-6	WCY109.....	J-8	WCY65PB.....	J-13
WCB250C2.....	J-9-10	WCY110.....	J-8	WCY66.....	J-7
WCB250C20.....	J-9-10	WCY111.....	J-8	WCY67.....	J-7
WCB250C250.....	J-9-10	WCY112.....	J-8	WCY68.....	J-7
WCB26.....	J-6	WCY113.....	J-8	WCY69.....	J-7
WCB27.....	J-6	WCY114.....	J-8	WCY70.....	J-7
WCB28.....	J-6	WCY115.....	J-8	WCY71.....	J-7
WCB2C2.....	J-9-10	WCY116.....	J-8	WCY72.....	J-7
WCB30C2.....	J-9-10	WCY117.....	J-8	WCY73.....	J-7
WCB40.....	J-6	WCY118.....	J-8	WCY74.....	J-7
WCB40C2.....	J-9-10	WCY119.....	J-8	WCY75.....	J-7
WCB40C20.....	J-9-10	WCY120.....	J-8	WCY76.....	J-7
WCB40C40.....	J-9-10	WCY121.....	J-8	WCY77.....	J-7
WCB41.....	J-6	WCY122.....	J-8	WCY78.....	J-7
WCB42.....	J-6	WCY123.....	J-8	WCY79.....	J-7
WCB43.....	J-6	WCY124.....	J-8	WCY80.....	J-7
WCB44.....	J-6	WCY125.....	J-8	WCY81.....	J-7
WCB45.....	J-6	WCY126.....	J-8	WCY82.....	J-7
WCB46.....	J-6	WCY127.....	J-8	WCY83.....	J-7
WCB47.....	J-6	WCY128.....	J-8	WCY84.....	J-7
WCB4C4.....	J-9-10	WCY129.....	J-8	WCY85.....	J-7
WCBB30R4N.....	J-13	WCY130.....	J-8	WCY86.....	J-7
WCBY39R4N.....	J-13	WCY131.....	J-8	WCY87.....	J-7
WCBY49R4N.....	J-13	WCY132.....	J-8	WCY88.....	J-7

ALPHA-NUMERIC INDEX BY CATALOG NUMBER

WCY89.....	J-7	WEEB-DSK516.....	E-158	WILEYBRAID12-34.....	E-168
WCY90.....	J-7	WEEB-DSK516-45.....	E-158	WILEYBRAID12-38.....	E-167
WCY91.....	J-7	WEEB-DSKBD34.....	E-158	WILEYBRAID12-516.....	E-167
WCY92.....	J-7	WEEB-ECR.....	E-161	WILEYBRAID12-916.....	E-168
WCY93.....	J-7	WEEB-FBM14.....	E-159	WILEYBRAID18.....	E-167
WCY94.....	J-7	WEEB-FBM516.....	E-159	WILEYBRAID18-12.....	E-168
WCY95.....	J-7	WEEB-JJR.....	E-161	WILEYBRAID18-34.....	E-168
WCY96.....	J-7	WEEB-KMC.....	E-161	WILEYBRAID18-38.....	E-167
WCY97.....	J-7	WEEB-KSR.....	E-161	WILEYBRAID18-516.....	E-167
WCY98.....	J-7	WEEB-LUG-10.3.....	E-156	WILEYBRAID18-916.....	E-168
WCY99.....	J-7	WEEB-LUG-15.8.....	E-156	WILEYBRAID24.....	E-167
WDA8300.....	N-5	WEEB-LUG-6.7.....	E-156	WILEYBRAID24-12.....	E-168
WDC4500.....	N-5	WEEB-LUG-6.7AS.....	E-156	WILEYBRAID24-34.....	E-168
WDIEKITAL.....	N-72	WEEB-LUG-8.0.....	E-156	WILEYBRAID24-38.....	E-167
WDIEKITCU.....	N-72	WEEB-LUG-8.0AS.....	E-156	WILEYBRAID24-516.....	E-167
WDIETREE.....	N-71, N-103	WEEB-LUG-8.0UN.....	E-156	WILEYBRAID24-916.....	E-168
WEEB-11.5.....	E-159	WEEB-LUG-8.2.....	E-156	WILEYBRAID30.....	E-167
WEEB-15.8.....	E-163	WEEB-M-KR.....	E-157	WILEYBRAID30-12.....	E-168
WEEB-2TC14.....	E-164	WEEB-MSNR516.....	E-157	WILEYBRAID30-34.....	E-168
WEEB-2TC38.....	E-164	WEEB-OCR.....	E-161	WILEYBRAID30-38.....	E-167
WEEB-6.7.....	E-163	WEEB-OSF.....	E-161	WILEYBRAID30-516.....	E-167
WEEB-8.0.....	E-163	WEEB-PMC.....	E-162	WILEYBRAID30-916.....	E-168
WEEB-8.2.....	E-163	WEEB-RLJ6C12-14.....	E-169	WILEYBRAID36.....	E-167
WEEB-9.5.....	E-159	WEEB-RLJ6C12-38.....	E-169	WILEYBRAID36-12.....	E-168
WEEB-9.5NL.....	E-159	WEEB-RLJ6C12-516.....	E-169	WILEYBRAID36-34.....	E-168
WEEB-ADC.....	E-160	WEEB-RLJ6C18-14.....	E-169	WILEYBRAID36-38.....	E-167
WEEB-ADR.....	E-160	WEEB-RLJ6C18-38.....	E-169	WILEYBRAID36-516.....	E-167
WEEB-ASR.....	E-160	WEEB-RLJ6C18-516.....	E-169	WILEYBRAID36-916.....	E-168
WEEB-ATF.....	E-160	WEEB-RLJ6C6-14.....	E-169	WILEYBRAID6.....	E-167
WEEB-BMC-1.....	E-157, E-160	WEEB-RLJ6C6-38.....	E-169	WILEYBRAID6-12.....	E-168
WEEB-BNDJMP12.....	E-166	WEEB-RLJ6C6-516.....	E-169	WILEYBRAID6-34.....	E-168
WEEB-BNDJMP12AS.....	E-166	WEEB-RPR.....	E-162	WILEYBRAID6-38.....	E-167
WEEB-BNDJMP18.....	E-166	WEEB-SCR.....	E-162	WILEYBRAID6-516.....	E-167
WEEB-BNDJMP18AS.....	E-166	WEEB-SMC-2.....	E-162	WILEYBRAID6-916.....	E-168
WEEB-BNDJMP24.....	E-166	WEEB-SSF.....	E-162	WILEYBRAID8-12.....	E-168
WEEB-BNDJMP24AS.....	E-166	WEEB-SSR.....	E-162	WILEYBRAID8-34.....	E-168
WEEB-BNDJMP36.....	E-166	WEEB-STC.....	E-162	WILEYBRAID8-916.....	E-168
WEEB-BNDJMP36AS.....	E-166	WEEB-TC14.....	E-165	WILEYBRAID9.....	E-167
WEEB-BNDJMP6.7.....	E-166	WEEB-TC38.....	E-166	WILEYBRAID9-38.....	E-167
WEEB-BNDJMP6.7AS.....	E-166	WEEB-UIR.....	E-159	WILEYBRAID9-516.....	E-167
WEEB-BNDJMP8.0.....	E-166	WEEB-UMC.....	E-162	WILEYLUG15.8.....	E-156
WEEB-BNDJMP8.0AS.....	E-166	WEEB-WMC.....	E-162	WILEYLUG6.7.....	E-156
WEEB-BNDJMP8.2.....	E-166	WHHWB.....	J-14, N-109	WILEYLUG8.0.....	E-156
WEEB-BNDJMP8.2MS.....	E-166	WHSCWH.....	J-14, N-110	WILEYLUG8.2.....	E-156
WEEB-BNDJMP9.....	E-166	WHSGB.....	J-14, N-110	WILEY-RLJ6C12-14.....	E-170
WEEB-CCR.....	E-160	WHSPBC.....	J-14, N-110	WILEY-RLJ6C12-38.....	E-170
WEEB-CCR-2.....	E-160	WHSSADP.....	J-14, N-110	WILEY-RLJ6C12-516.....	E-170
WEEB-CMC.....	E-160	WHSTA.....	J-14, N-110	WILEY-RLJ6C18-14.....	E-170
WEEB-DHF.....	E-160	WHSWB.....	J-14, N-110	WILEY-RLJ6C18-38.....	E-170
WEEB-DMC.....	E-161	WHSWHADP.....	J-14, N-110	WILEY-RLJ6C18-516.....	E-170
WEEB-DPF.....	E-161	WILEYBRAID10-12.....	E-168	WILEY-RLJ6C6-14.....	E-170
WEEB-DPR.....	E-161	WILEYBRAID10-34.....	E-168	WILEY-RLJ6C6-38.....	E-170
WEEB-DSK12.....	E-158	WILEYBRAID10-916.....	E-168	WILEY-RLJ6C6-516.....	E-170
WEEB-DSK14.....	E-158	WILEYBRAID12.....	E-167	WIPC14-1.....	E-155, G-26
WEEB-DSK38.....	E-158	WILEYBRAID12-12.....	E-168	WIPC14-112.....	E-155, G-26

ALPHA-NUMERIC INDEX BY CATALOG NUMBER

WIPC14-12.....	E-155, G-26	WSL8.....	J-11	Y122CMRKIT.....	N-49-50
WIPC14-14.....	E-155, G-26	WSL9.....	J-11	Y1MRKIT.....	N-48
WIPC14-34.....	E-155, G-26	WSM1.....	J-11	Y1MRTC.....	N-48
WIEMIKE.....	F-14, N-106	WSM10.....	J-11	Y1MRTCKIT.....	N-48
WIEMIKECI.....	F-14, N-106	WSM2.....	J-11	Y281CR.....	C-178
WIEMIKED.....	F-14, N-106	WSM3.....	J-11	Y2825R.....	C-178
WLB15A.....	M-22	WSM4.....	J-11	Y2826R.....	C-178
WLB16A.....	M-22	WSM5.....	J-11	Y2827R.....	C-178
WLB17A.....	M-22	WSM6.....	J-11	Y282CR.....	C-178
WLB18A.....	M-22	WSM7.....	J-11	Y284CR.....	C-178
WLB19A.....	M-22	WSM8.....	J-11	Y284WR.....	C-178
WLB20A.....	M-22	WSM9.....	J-11	Y286CR.....	C-178
WLB21A.....	M-22	WSS1.....	J-11	Y2928R.....	C-178
WLB22A.....	M-22	WSS2.....	J-11	Y29BH.....	N-39
WLB24A.....	M-22	WT2B2RBYK.....	J-15	Y29PL.....	N-39
WLB58A.....	M-22	WT2B2RBYWABAG.....	J-15, N-109	Y29PLE.....	N-39
WLB59A.....	M-22	WT2BRBYK.....	J-15	Y29PLE1.....	N-39
WLB90A.....	M-22	WT2BRBYWABAG.....	J-15	Y29PR.....	N-39
WLB92A.....	M-22		J-12, J-15,	Y3025R.....	C-178
WPBBNBOX25.....	J-5, N-108	WTB.....	N-108-109	Y3026R.....	C-178
WPBRNBOX25.....	J-5, N-108	WTBASY1.....	J-12, N-108	Y3027R.....	C-178
WPBYNBOX25.....	J-5, N-108	WTBGBW.....	J-15, N-109	Y3028R.....	C-178
WS14A.....	M-12	WTBGBWRBYK.....	J-15, N-109	Y302CR.....	C-178
WS15A.....	M-12	WTBNHS.....	J-15, N-109	Y304CR.....	C-178
WS16A.....	M-12	WTCC.....	J-15, N-109	Y3126R.....	C-178
WS17A.....	M-12		J-12, J-15,	Y3128R.....	C-178
WS18A.....	M-12	WTCK.....	N-108-109	Y3129R.....	C-178
WS19A.....	M-12		J-12, J-15,	Y3425R.....	C-178
WS20A.....	M-12	WTHRBTIS.....	N-108-109	Y3426R.....	C-178
WS21A.....	M-12		J-12, J-15,	Y3427R.....	C-178
WS22A.....	M-12	WTHY1S.....	N-108-109	Y3428R.....	C-178
WS24A.....	M-12		J-12, J-15,	Y3429R.....	C-178
WS58A.....	M-12	WTOCBR.....	N-108-109	Y342CR.....	C-178
WS59A.....	M-12		J-12, J-15,	Y3430R.....	C-178
WS86A.....	M-12	WTOCY.....	N-108-109	Y3431R.....	C-178
WS90A.....	M-12	WTRB.....	J-15, N-109	Y3432R.....	C-178
WS91A.....	M-12	WTRBK.....	J-15, N-109	Y34BH.....	N-38
WS92A.....	M-12	WTRBKNHS.....	J-15, N-109	Y34PA.....	N-38
WS94A.....	M-12	WTRBKNHSBAG.....	J-15, N-109	Y34PR.....	N-38
WS96A.....	M-12	WTRBWABAG.....	J-15	Y34PR11.....	N-38
WSBC128A.....	M-21	WTRBYK.....	J-15, N-109	Y34PR5.....	N-38
WSBC74A.....	M-21	WTRBYKNHS.....	J-15, N-109	Y35.....	N-24
WSBC83A.....	M-21	WTRBYKNHSBAG.....	J-15, N-109	Y35/Y39REPKITA.....	N-24, N-104
WSL1.....	J-11	WTRBYWABAG.....	J-15, N-109	Y352.....	N-24
WSL10.....	J-11	WTY.....	J-15, N-109	Y35BH.....	N-34
WSL11.....	J-11	WTYK.....	J-15, N-109	Y35BH4.....	N-34
WSL12.....	J-11	WTYKNHS.....	J-15, N-109	Y35H.....	N-34
WSL13.....	J-11	WTYKNHSBAG.....	J-15	Y3934R.....	C-178
WSL14.....	J-11	WTYWABAG.....	J-15	Y3936R.....	C-178
WSL2.....	J-11	X8CART.....	N-71-72	Y4439R.....	C-178
WSL3.....	J-11	Y10AC9.....	N-93	Y444SBH.....	N-35
WSL4.....	J-11	Y10AC9OEM.....	N-93	Y444SBHF.....	N-35
WSL5.....	J-11	Y10D.....	N-40	Y45.....	N-32
WSL6.....	J-11	Y122CMR.....	N-49	Y46CLWSBH.....	N-30
WSL7.....	J-11	Y122CMRCIKIT.....	N-49-50	Y46CLWSBHF.....	N-30

ALPHA-NUMERIC INDEX BY CATALOG NUMBER

Y46LWBH.....	N-31	YA252NTC38.....	C-50	YA26L2BOX.....	C-15
Y46LWBHF.....	N-31	YA252NU.....	C-60	YA26L2NT14.....	C-27
Y46LWSBH.....	N-30	YA252TC14.....	C-50	YA26L2NT14E1.....	C-27
Y46LWSBHF.....	N-30	YA252TC14E2.....	C-50	YA26L2TC14.....	C-24
Y4PC834.....	N-27	YA252TC38.....	C-50	YA26L2TC14E1.....	C-24
Y4PC834MBH.....	N-37	YA252TC516.....	C-50	YA26L2TC14E2.....	C-24
Y500CTHS.....	N-28	YA25A1.....	C-118	YA26L2TC38.....	C-24
Y60LW.....	N-29	YA25A1S60T516E.....	C-124	YA26L3.....	C-15
Y60LWCASE.....	N-29	YA25A3.....	C-118	YA26L4TCG1.....	C-29
Y60LWSTAND.....	N-29	YA25A3N69T38E.....	C-124	YA26L60.....	C-15
Y644HSCASE.....	N-25	YA25A5.....	C-121	YA26L6BOX.....	C-15
Y644HSXT.....	N-25	YA25A7.....	C-121	YA26LB.....	C-77
Y750BHXT.....	N-33	YA25A9.....	C-118	YA26LBOX.....	C-15
Y750CHSXT.....	N-23	YA25L2BOX.....	C-15	YA26LN50T14E.....	C-31
Y750HSXT.....	N-23	YA25L2NT14.....	C-27	YA26LNT10.....	C-19
Y81K2.....	N-26	YA25L2NT14E1.....	C-27	YA26LNT14.....	C-19
Y81K2MBH.....	N-36	YA25L2TC14.....	C-23	YA26LNT38.....	C-19
Y8MRB1.....	N-43	YA25L2TC14E1.....	C-23	YA26LNT516.....	C-19
YA10ATN.....	C-118	YA25L2TC14E2.....	C-23	YA26N.....	C-42
YA12ATN.....	C-118	YA25L2TC38.....	C-23	YA26TC14.....	C-42
YA1C.....	C-41	YA25L4BOX.....	C-15	YA26TC516.....	C-42
YA1C2L.....	C-23	YA25L4TCG1.....	C-29	YA27.....	C-42
YA1C2LN.....	C-23	YA25L6.....	C-15	YA272LN.....	C-24
YA1C2N.....	C-50, C-53	YA25LB.....	C-77	YA272N.....	C-50
YA1C2NT10.....	C-53	YA25LBOX.....	C-15	YA272NT14.....	C-53
YA1C2NT14.....	C-53	YA25LN50T14E.....	C-31	YA272NT38.....	C-53
YA1C2NT14E2.....	C-53	YA25LN64T516E.....	C-31	YA272NT516.....	C-53
YA1C2NU.....	C-59	YA25LNT10.....	C-19	YA272NU.....	C-60
YA1C2TC14.....	C-50	YA25LNT14.....	C-19	YA272TC14E2.....	C-50
YA1C2TC14E2.....	C-50	YA25LNT38.....	C-19	YA272TC38.....	C-50
YA1C2TC38.....	C-50, C-53	YA25LNT516.....	C-19	YA27A1.....	C-118
YA1CA1.....	C-118	YA25N.....	C-42	YA27A10S76T516E.....	C-124
YA1CL2.....	C-14	YA25TC10.....	C-42	YA27A3.....	C-118
YA1CL2NT14.....	C-27	YA25TC38.....	C-42	YA27A5.....	C-121
YA1CL2NT14E2.....	C-27	YA26.....	C-42	YA27A7.....	C-121
YA1CL2TC14.....	C-23	YA262L.....	C-24	YA27L2NT14.....	C-27
YA1CL2TC14E2.....	C-23	YA262LH89.....	H-42	YA27L2NT38.....	C-27
YA1CL2TC38.....	C-23	YA262LN.....	C-24	YA27L2NT516.....	C-27
YA1CL4BOX.....	C-14	YA262N.....	C-50	YA27L2TC14E2.....	C-24
YA1CL6BOX.....	C-14	YA262NT14.....	C-53	YA27L2TC38.....	C-24
YA1CLB.....	C-77	YA262NT14E1.....	C-53	YA27L3.....	C-15
YA1CLBOX.....	C-14	YA262NT38.....	C-53	YA27L4BOX.....	C-15
YA1CLNT10.....	C-19	YA262NT516.....	C-53	YA27L4TCG1.....	C-29
YA1CLNT14.....	C-19	YA262NU.....	C-60	YA27LB.....	C-77
YA1CN.....	C-41	YA262TC14.....	C-50	YA27LBOX.....	C-15
YA1CTC10.....	C-41	YA262TC14E2.....	C-50	YA27LNT14.....	C-19
YA1CTC14.....	C-41	YA262TC38.....	C-50	YA27LNT38.....	C-19
YA1CTC38.....	C-41	YA26A1.....	C-118	YA27LNT516.....	C-19
YA25.....	C-42	YA26A13N100T516E.....	C-124	YA28.....	C-42
YA252L.....	C-23	YA26A3.....	C-121	YA282LH114.....	H-42
YA252LN.....	C-23	YA26A5.....	C-121	YA282LH115.....	H-42
YA252N.....	C-50	YA26A6.....	C-118	YA282LN.....	C-24
YA252NT14.....	C-53	YA26A6N100T38E.....	C-124	YA282N.....	C-50
YA252NT14E1.....	C-53	YA26A7.....	C-118	YA282NT14.....	C-53
YA252NT38.....	C-53	YA26A8.....	C-118	YA282NT38.....	C-53

ALPHA-NUMERIC INDEX BY CATALOG NUMBER

YA282NT516.....	C-53	YA29LENT38.....	C-20	YA30A1.....	C-118
YA282NTC38.....	C-50	YA29LENT516.....	C-20	YA30A1N131T12E.....	C-124
YA282NU.....	C-60	YA29LNT38.....	C-20	YA30A3.....	C-121
YA282TC14E2.....	C-50	YA29LTC78.....	C-15	YA30A5.....	C-121
YA282TC38.....	C-50	YA2C.....	C-41	YA30A6.....	C-118
YA28A1.....	C-118	YA2C2L.....	C-23	YA30A6N100T38E.....	C-124
YA28A14N100T516E.....	C-124	YA2C2LN.....	C-23	YA30A9N100T516E.....	C-124
YA28A1N100T38E.....	C-124	YA2C2N.....	C-49	YA30L.....	C-15
YA28A3.....	C-118	YA2C2NT14.....	C-53	YA30L1.....	C-15
YA28A5.....	C-121	YA2C2NT14E1.....	C-53	YA30L24.....	C-15
YA28A7.....	C-121	YA2C2NT14E2.....	C-53	YA30L24N100T38E.....	C-31
YA28L2.....	C-15	YA2C2NTC38.....	C-49	YA30L27.....	C-15
YA28L2NT14.....	C-27	YA2C2NU.....	C-59	YA30L28.....	C-15
YA28L2NTC516.....	C-24	YA2C2TC14.....	C-49	YA30L2NTCFX.....	C-84
YA28L2TC14E1.....	C-24	YA2C2TC14E2.....	C-49	YA30L2TC38.....	C-24
YA28L2TC14E2.....	C-24	YA2C2TC38.....	C-49	YA30L2TC38FX.....	C-84
YA28L2TC38.....	C-24	YA2C2TC38E2.....	C-49	YA30L2TC516FX.....	C-84
YA28L2TC38E2.....	C-24	YA2C2TC38E6.....	C-49	YA30L7.....	C-15
YA28L3.....	C-15	YA2C2TC38SL.....	C-56	YA30LB.....	C-77
YA28L4BOX.....	C-15	YA2C2TC38SLBOX500.....	C-56	YA30LN.....	C-15
YA28L4TCG1.....	C-29	YA2C2TC516E2.....	C-49	YA30LNT14.....	C-20
YA28L56.....	C-15	YA2CA1.....	C-118	YA30LNT38.....	C-20
YA28LB.....	C-77	YA2CA1S91T516E.....	C-124	YA30LNT516FX.....	C-75
YA28LBOX.....	C-15	YA2CA3.....	C-118	YA30LTC12FX.....	C-69
YA28LNT14.....	C-19	YA2CA5.....	C-118	YA30LTC34FX.....	C-69
YA28LNT38.....	C-19	YA2CA5S53T14E.....	C-124	YA30LTC38FX.....	C-69
YA28LNT516.....	C-19	YA2CA9.....	C-121	YA30LTC516FX.....	C-69
YA28N.....	C-42	YA2CL2BOX.....	C-14	YA30LTC58FX.....	C-69
YA28TC38.....	C-42	YA2CL2NT14.....	C-27	YA30N.....	C-42
YA29.....	C-42	YA2CL2NT14E1.....	C-27	YA30TC12FXB.....	C-101
YA292LH91.....	H-42	YA2CL2NT14E2.....	C-27	YA31.....	C-42
YA292LN.....	C-24	YA2CL2TC14.....	C-23	YA312LH90.....	H-42
YA292N.....	C-50	YA2CL2TC14E1.....	C-23	YA312LN.....	C-24
YA292NNT.....	C-53	YA2CL2TC14E2.....	C-23	YA312N.....	C-50
YA292NT14.....	C-53	YA2CL2TC38.....	C-23	YA312NFXB.....	C-108
YA292NT38.....	C-53	YA2CL2TC516.....	C-23	YA312NT38.....	C-54
YA292NT38E16.....	C-53	YA2CL4BOX.....	C-14	YA312NT38E16.....	C-54
YA292NT516.....	C-53	YA2CL6BOX.....	C-14	YA312NU.....	C-60
YA292NU.....	C-60	YA2CLB.....	C-77	YA312TC14E2.....	C-50
YA292TC38.....	C-50	YA2CLBOX.....	C-14	YA312TC38.....	C-50
YA292TC58E16.....	C-50	YA2CLNT10.....	C-19	YA312TC38FXB.....	C-108
YA29A1.....	C-118	YA2CLNT14.....	C-19	YA31A1.....	C-118
YA29A3.....	C-121	YA2CLNT516.....	C-19	YA31A1N100T516E.....	C-124
YA29A5.....	C-121	YA2CN.....	C-41	YA31A2.....	C-118
YA29A6.....	C-118	YA2CTC10.....	C-41	YA31A3.....	C-121
YA29A9.....	C-118	YA2CTC14.....	C-41	YA31A5.....	C-121
YA29L2.....	C-15	YA2CTC38.....	C-41	YA31A6.....	C-118
YA29L2NT38.....	C-27	YA30.....	C-42	YA31A9N100T38E.....	C-124
YA29L2NT38E16.....	C-27	YA302LH85.....	H-42	YA31L.....	C-16
YA29L2TC38.....	C-24	YA302LN.....	C-24	YA31L11.....	C-16
YA29L4.....	C-15	YA302N.....	C-50	YA31L2NT38.....	C-27
YA29L4TCG1.....	C-29	YA302NFXB.....	C-108	YA31L2NT38E16.....	C-27
YA29L7.....	C-15	YA302NT38.....	C-54	YA31L2NT38FX.....	C-86
YA29LB.....	C-77	YA302NU.....	C-60	YA31L2NTC516.....	C-24
YA29LBOX.....	C-15	YA302TC38.....	C-50	YA31L2NTCFX.....	C-84

ALPHA-NUMERIC INDEX BY CATALOG NUMBER

YA31L2TC12.....	C-24	YA32TC12FXB.....	C-101	YA34LTC516FX.....	C-70
YA31L2TC12FX.....	C-84	YA33.....	C-42	YA34LTC58FX.....	C-70
YA31L2TC14E2.....	C-24	YA332N.....	C-50	YA34N.....	C-42
YA31L2TC38.....	C-24	YA33L.....	C-16	YA34TC12FXB.....	C-102
YA31L2TC38FX.....	C-84	YA33N.....	C-42	YA352L.....	C-25
YA31L36.....	C-16	YA34.....	C-42	YA352LN.....	C-25
YA31L4TCG1.....	C-29	YA342L.....	C-25	YA352N.....	C-51
YA31L7.....	C-16	YA342LH110.....	H-42	YA36.....	C-42
YA31LB.....	C-77	YA342LH111.....	H-42	YA362LN.....	C-25
YA31LNT12.....	C-20	YA342LN.....	C-25	YA362N.....	C-51
YA31LNT12FX.....	C-70, C-75	YA342LNN119T12E.....	C-31	YA362NFXB.....	C-108
YA31LNT38.....	C-20	YA342LNN131T12E.....	C-31	YA362NNT.....	C-54
YA31LTC12FX.....	C-70	YA342N.....	C-51	YA362NT12.....	C-54
YA31LTC14FX.....	C-70	YA342NFXB.....	C-108	YA362NT38.....	C-54
YA31LTC34FX.....	C-70	YA342NNT.....	C-54	YA362NU.....	C-60
YA31LTC38FX.....	C-70	YA342NT38.....	C-54	YA362TC38.....	C-51
YA31LTC516FX.....	C-70	YA342NT38E16.....	C-54	YA36A1.....	C-119
YA31LTC58FX.....	C-70	YA342NT58.....	C-54	YA36A3.....	C-121
YA31TC12FXB.....	C-101	YA342NU.....	C-60	YA36A3N131TD12E.....	C-124
YA32.....	C-42	YA342TC14E2.....	C-51	YA36A3N131TD38E.....	C-124
YA322L.....	C-24	YA342TC38.....	C-51	YA36A5.....	C-121
YA322LN.....	C-24	YA342TC38FXB.....	C-108	YA36A8.....	C-119
YA322N.....	C-50	YA34A1.....	C-118	YA36A9N131TD12E.....	C-124
YA322NFXB.....	C-108	YA34A3.....	C-121	YA36L.....	C-16
YA322NNT.....	C-54	YA34A3N131T12E.....	C-124	YA36L11.....	C-16
YA322NT38.....	C-54	YA34A5.....	C-121	YA36L2ENT38E10FX.....	C-86
YA322NU.....	C-60	YA34A7.....	C-118	YA36L2NNT.....	C-27
YA322TC38.....	C-50	YA34A7N131T12E.....	C-124	YA36L2NT38FX.....	C-86
YA322TC38FXB.....	C-108	YA34A8N131T38E.....	C-124	YA36L2NTCFX.....	C-84
YA32A1.....	C-118	YA34L.....	C-16	YA36L2TC38.....	C-25
YA32A3.....	C-121	YA34L20.....	C-16	YA36L2TC38FX.....	C-84
YA32A5.....	C-121	YA34L2NT12E1.....	C-27	YA36LB.....	C-77
YA32A6.....	C-118	YA34L2NT38.....	C-27	YA36LNT12.....	C-20
YA32A8N106T516E.....	C-124	YA34L2NT38E16.....	C-27	YA36LNT38.....	C-20
YA32A9.....	C-118	YA34L2NT38FX.....	C-86	YA36LTC12FX.....	C-70
YA32L.....	C-16	YA34L2NTC38FX.....	C-84	YA36LTC58FX.....	C-70
YA32L1.....	C-16	YA34L2NTCFX.....	C-84	YA36LTC78.....	C-16
YA32L14.....	C-16	YA34L2TC12.....	C-25	YA36N.....	C-42
YA32L2NT38FX.....	C-86	YA34L2TC12FX.....	C-84	YA36TC12FXB.....	C-102
YA32L2NTCFX.....	C-84	YA34L2TC14E2.....	C-25	YA36TC58FXB.....	C-102
YA32L2TC38.....	C-24	YA34L2TC38.....	C-25	YA37.....	C-42
YA32L2TC38E5.....	C-24	YA34L2TC38FX.....	C-84	YA372L.....	C-25
YA32L2TC38FX.....	C-84	YA34L2TC516FX.....	C-84	YA372LN.....	C-25
YA32LB.....	C-77	YA34L37.....	C-16	YA372N.....	C-51
YA32LN.....	C-16	YA34L6.....	C-16	YA37L.....	C-16
YA32LNT12.....	C-20	YA34L6N131T12E.....	C-31	YA37L1.....	C-16
YA32LNT38.....	C-20	YA34L8.....	C-16	YA37N.....	C-42
YA32LNT38FX.....	C-75	YA34L9.....	C-16	YA38.....	C-42
YA32LNT516FX.....	C-75	YA34LB.....	C-77	YA382FXBG2.....	C-108
YA32LTC100FX.....	C-70	YA34LNT12.....	C-20	YA382FXBG3.....	C-108
YA32LTC12FX.....	C-70	YA34LNT12FX.....	C-75	YA382L.....	C-25
YA32LTC38FX.....	C-70	YA34LNT38.....	C-20	YA382LN.....	C-25
YA32LTC58FX.....	C-70	YA34LNT38FX.....	C-75	YA382N.....	C-51
YA32LTC78.....	C-16	YA34LTC12FX.....	C-70	YA382NFXB.....	C-108
YA32N.....	C-42	YA34LTC38FX.....	C-70	YA382TC38.....	C-51

ALPHA-NUMERIC INDEX BY CATALOG NUMBER

YA382TC38FXB.....	C-108	YA39LNT12.....	C-20	YA442N.....	C-51
YA38L.....	C-16	YA39LNT38.....	C-20	YA442NFXB.....	C-108
YA38L2ENT38FX.....	C-86	YA39LNT58.....	C-20	YA442NU.....	C-60
YA38L2NNTFX.....	C-86	YA39N.....	C-43	YA442TC38.....	C-51
YA38L2NT38FX.....	C-86	YA3C.....	C-41	YA442TC38FXB.....	C-108
YA38L2NTCFX.....	C-84	YA3C2L.....	C-23	YA444N.....	C-57
YA38L2TC12.....	C-25	YA3C2N.....	C-49	YA444NU.....	C-61
YA38L2TC12FX.....	C-84	YA3C2NU.....	C-59	YA44A1.....	C-119
YA38L2TC38.....	C-25	YA3C2TC14.....	C-49	YA44A3.....	C-122
YA38L2TC38FX.....	C-84	YA3C2TC14E2.....	C-49	YA44A8.....	C-122
YA38L2TC516FX.....	C-84	YA3C2TC38.....	C-49	YA44L.....	C-16
YA38LB.....	C-77	YA3C2TC38E2.....	C-49	YA44L2.....	C-16
YA38LNT12FX.....	C-75	YA3C2TC38FXB.....	C-107	YA44L23.....	C-16
YA38LNTM20FX.....	C-75	YA3C2TC38SL.....	C-56	YA44L2NNTFX.....	C-86
YA38LTC12FX.....	C-70	YA3C2TC38SLBOX500.....	C-56	YA44L2NNTFXSL.....	C-28, C-87
YA38LTC38FX.....	C-70	YA3C2TC516FXB.....	C-107	YA44L2NT38FX.....	C-86
YA38LTC516FX.....	C-70	YA3CL.....	C-14	YA44L2NTC12E24.....	C-27
YA38LTC58FX.....	C-70	YA3CL2TC14.....	C-23	YA44L2NTCFX.....	C-84
YA38N.....	C-42	YA3CL2TC38.....	C-23	YA44L2TC12.....	C-25
YA38TC12FXB.....	C-102	YA3CLB.....	C-77	YA44L2TC12E3FX.....	C-84
YA38TC58FXB.....	C-102	YA3CLNT14.....	C-19	YA44L2TC12FX.....	C-84
YA39.....	C-43	YA3CLNT516.....	C-19	YA44L2TC38FX.....	C-84
YA392ENNT.....	C-51, C-54	YA3CN.....	C-41	YA44L2TC58FX.....	C-84
YA392L.....	C-25	YA3CTC14.....	C-41	YA44LB.....	C-77
YA392LN.....	C-25	YA3CTC38.....	C-41	YA44LNT12FX.....	C-75
YA392LNN131T12E.....	C-31	YA40.....	C-43	YA44LNT38FX.....	C-75
YA392N.....	C-51	YA402L.....	C-25	YA44LTC12FX.....	C-70
YA392NNT.....	C-54	YA402LN.....	C-25	YA44LTC58FX.....	C-70
YA392NT38.....	C-51, C-54	YA402N.....	C-51	YA44N.....	C-43
YA392NT38E16.....	C-54	YA402NFXB.....	C-108	YA44TC58FXB.....	C-102
YA392NT58.....	C-54	YA402NU.....	C-60	YA45.....	C-43
YA392NU.....	C-60	YA40L.....	C-16	YA452N.....	C-51
YA392TC38.....	C-51	YA40L2NNTFX.....	C-86	YA452NU.....	C-61
YA39A1.....	C-119	YA40L2NTCFX.....	C-84	YA4532N.....	C-51
YA39A1N131TD12E.....	C-124	YA40L2TC38.....	C-25	YA453LBOX.....	C-17
YA39A3.....	C-119	YA40L2TC38FX.....	C-84	YA454N.....	C-57
YA39A34.....	C-119	YA40LB.....	C-77	YA454NU.....	C-61
YA39A5.....	C-122	YA40LENT12FX.....	C-75	YA45A5.....	C-122
YA39A5N131TD12E.....	C-124	YA40LTC12FX.....	C-70	YA45L.....	C-17
YA39A7.....	C-122	YA40LTC38FX.....	C-70	YA45L2NT38FX.....	C-86
YA39AM2.....	C-122	YA40LTC516FX.....	C-70	YA46.....	C-43
YA39L.....	C-16	YA40LTC58FX.....	C-70	YA462N.....	C-51
YA39L2.....	C-16	YA40TC58FXB.....	C-102	YA462NFXB.....	C-108
YA39L2NT12E1.....	C-27	YA41.....	C-43	YA462NU.....	C-61
YA39L2NT38.....	C-27	YA412L.....	C-25	YA464N.....	C-57
YA39L2NT38E16.....	C-27	YA412N.....	C-51	YA464NU.....	C-61
YA39L2NTCFX.....	C-84	YA41L.....	C-16	YA46A3.....	C-122
YA39L2TC12E3.....	C-25	YA41N.....	C-43	YA46A5.....	C-122
YA39L2TC38.....	C-25	YA42A1.....	C-119	YA46L.....	C-17
YA39L2TC38E10FX.....	C-84	YA42A3.....	C-119	YA46N.....	C-43
YA39L2TC58.....	C-25	YA42A5.....	C-122	YA46TC58FXB.....	C-102
YA39L6.....	C-16	YA42A7.....	C-122	YA47.....	C-43
YA39L6N131T12E.....	C-31	YA44.....	C-43	YA472N.....	C-51
YA39L9.....	C-16	YA442L.....	C-25	YA472NU.....	C-61
YA39LB.....	C-77	YA442LN.....	C-25	YA474N.....	C-57

ALPHA-NUMERIC INDEX BY CATALOG NUMBER

YA47N.....	C-43	YA6C2TC14E2.....	C-49	YA8CTC10.....	C-41
YA48.....	C-43	YA6C2TC38.....	C-49	YA8CTC14.....	C-41
YA482N.....	C-51	YA6C2TC38E2.....	C-49	YA8CTC14FXB.....	C-101
YA482NU.....	C-61	YA6C2TC38E6.....	C-49	YA8CTC38.....	C-41
YA484N.....	C-57	YA6C2TC38SL.....	C-56	YAAKIT1.....	C-129
YA4864N.....	C-57	YA6C2TC38SLBOX500.....	C-56	YAAKIT2.....	C-129
YA48A3.....	C-122	YA6CA1.....	C-118	YAAKIT3.....	C-129
YA48L.....	C-17	YA6CA3.....	C-118	YAB252LH70.....	H-42
YA48N.....	C-43	YA6CL1BOX.....	C-14	YAB252LH71.....	H-42
YA4C.....	C-41	YA6CL231.....	B-16	YAB2C2LH74.....	H-42
YA4C2L.....	C-23	YA6CL2TC10.....	C-22	YAB2C2LH75.....	H-42
YA4C2LN.....	C-23	YA6CL2TC14.....	C-22	YAB344N.....	C-57
YA4C2N.....	C-49	YA6CL2TC14E.....	C-22	YAB364N.....	C-57
YA4C2NT10.....	C-53	YA6CL2TC14E1.....	C-22	YAB394N.....	C-57
YA4C2NT14.....	C-53	YA6CL2TC14E2.....	C-22	YAB4C2LH72.....	H-42
YA4C2NU.....	C-59	YA6CL2TC14E2SL.....	C-28, C-87	YACCASE.....	N-93
YA4C2TC14.....	C-49	YA6CL2TC38.....	C-22	YACFC.....	N-93
YA4C2TC14E2.....	C-49	YA6CL2TC516.....	C-22	YAD1010.....	B-5
YA4C2TC38.....	C-49	YA6CL2TC516E2.....	C-22	YAD1010F.....	B-29
YA4CA1.....	C-118	YA6CL3BOX.....	C-14	YAD1014.....	B-5
YA4CA3.....	C-118	YA6CL4BOX.....	C-14	YAD1014F.....	B-29
YA4CA6.....	C-118	YA6CL6.....	C-14	YAD1014M.....	B-5
YA4CL1BOX.....	C-14	YA6CLBOX.....	C-14	YAD1038.....	B-5
YA4CL2TC14.....	C-23	YA6CLNT6.....	C-19	YAD1038M.....	B-5
YA4CL2TC14E1.....	C-23	YA6CN.....	C-41	YAD10516.....	B-5
YA4CL2TC14E2.....	C-23	YA6CTC10.....	C-41	YAD10516M.....	B-5
YA4CL2TC38.....	C-23	YA6CTC38.....	C-41	YAD106.....	B-5
YA4CL2TC516.....	C-23	YA6CTC516.....	C-41	YAD106F.....	B-29
YA4CL3BOX.....	C-14	YA6CTC8.....	C-41	YAD108.....	B-5
YA4CL4BOX.....	C-14	YA8C2LN.....	C-22	YAD108F.....	B-29
YA4CL6BOX.....	C-14	YA8C2N.....	C-49	YAD108M.....	B-5
YA4CLB.....	C-77	YA8C2NT8.....	C-53	YAD1410.....	B-5
YA4CLBOX.....	C-14	YA8C2NU.....	C-59	YAD1410F.....	B-29
YA4CLNT10.....	C-19	YA8C2TC14.....	C-49	YAD1410M.....	B-5
YA4CN.....	C-41	YA8C2TC14E2.....	C-49	YAD1414.....	B-5
YA4CTC10.....	C-41	YA8C2TC14E2FXB.....	C-107	YAD1414F.....	B-29
YA4CTC38.....	C-41	YA8C2TC38.....	C-49	YAD1414M.....	B-5
YA5C.....	C-41	YA8C2TC38FXB.....	C-107	YAD1438.....	B-5
YA5C2L.....	C-22	YA8CA1.....	C-118	YAD1438M.....	B-5
YA5C2N.....	C-49	YA8CA3.....	C-118	YAD144.....	B-5
YA5C2NU.....	C-59	YA8CA3S56T14E.....	C-124	YAD14516.....	B-5
YA5CL.....	C-14	YA8CL1BOX.....	C-14, C-68	YAD146.....	B-5
YA5CLB.....	C-77	YA8CL2BOX.....	C-14, C-68	YAD146F.....	B-29
YA5CN.....	C-41	YA8CL2TC10.....	C-22, C-82	YAD146M.....	B-5
YA5CTC14FXB.....	C-101	YA8CL2TC10E2.....	C-22	YAD148.....	B-5
YA6C.....	C-41	YA8CL2TC14.....	C-22, C-82	YAD148F.....	B-29
YA6C2L.....	C-22	YA8CL2TC14E1.....	C-22, C-82	YAD148M.....	B-5
YA6C2L51.....	C-22	YA8CL2TC14E2.....	C-22, C-82	YAD1810.....	B-5
YA6C2L52.....	C-22	YA8CL2TC38.....	C-22, C-82	YAD1810F.....	B-29
YA6C2LN.....	C-22	YA8CL3BOX.....	C-14, C-68	YAD1810M.....	B-5
YA6C2N.....	C-49	YA8CL4BOX.....	C-14, C-68	YAD1814.....	B-5
YA6C2NT8.....	C-53	YA8CLB.....	C-77	YAD1814F.....	B-29
YA6C2NU.....	C-59	YA8CLBOX.....	C-14, C-68	YAD1814M.....	B-5
YA6C2TC14.....	C-49	YA8CLNT6.....	C-19	YAD1838.....	B-5
YA6C2TC14E1.....	C-49	YA8CLNT8.....	C-19	YAD184.....	B-5

ALPHA-NUMERIC INDEX BY CATALOG NUMBER

YAD184M.....	B-5	YAD36M10E38.....	B-7	YAE12N1M.....	B-11
YAD18516.....	B-5	YAD36M12E12.....	B-7	YAE12N2.....	B-11
YAD186.....	B-5	YAD36M16E58.....	B-7	YAE12N2BOX.....	B-11
YAD186F.....	B-29	YAD36M20E34.....	B-7	YAE12N2M.....	B-11
YAD186M.....	B-5	YAD4CM10E38.....	B-6	YAE12N7.....	B-11
YAD188.....	B-5	YAD4CM12E12.....	B-6	YAE12N7BOX.....	B-11
YAD188F.....	B-29	YAD4CM16E58.....	B-6	YAE12N7M.....	B-11
YAD188M.....	B-5	YAD4CM20E34.....	B-6	YAE12N9.....	B-11
YAD1CM10E38.....	B-6	YAD4CM5E10.....	B-6	YAE12N9BOX.....	B-11
YAD1CM12E12.....	B-6	YAD4CM6E14.....	B-6	YAE12N9M.....	B-11
YAD1CM16E58.....	B-6	YAD4CM8E516.....	B-6	YAE12NBOX.....	B-11
YAD1CM20E34.....	B-6	YAD6CM10E38.....	B-6	YAE12NM.....	B-11
YAD1CM6E14.....	B-6	YAD6CM12E12.....	B-6	YAE12Z2.....	B-46
YAD1CM8E516.....	B-6	YAD6CM5E10.....	B-6	YAE12Z2BOX.....	B-46
YAD25M10E38.....	B-6	YAD6CM6E14.....	B-6	YAE12Z3.....	B-46
YAD25M12E12.....	B-6	YAD6CM8E516.....	B-6	YAE12Z3BOX.....	B-46
YAD25M16E58.....	B-6	YAD8CM10E38.....	B-6	YAE12Z4.....	B-46
YAD25M20E34.....	B-6	YAD8CM12E12.....	B-6	YAE12Z4BOX.....	B-46
YAD25M6E14.....	B-6	YAD8CM16E58.....	B-6	YAE14N.....	B-11
YAD25M8E516.....	B-6	YAD8CM4E8.....	B-6	YAE14N1.....	B-11
YAD26M10E38.....	B-7	YAD8CM5E10.....	B-6	YAE14N107BFBOX.....	B-42
YAD26M12E12.....	B-7	YAD8CM6E14.....	B-6	YAE14N107LFBOX.....	B-38
YAD26M16E58.....	B-7	YAD8CM8E516.....	B-6	YAE14N108BFBOX.....	B-42
YAD26M20E34.....	B-7	YAE10N.....	B-11	YAE14N108LFBOX.....	B-38
YAD26M6E14.....	B-7	YAE10N11.....	B-11	YAE14N109BFBOX.....	B-42
YAD26M8E516.....	B-7	YAE10N110BFBOX.....	B-42	YAE14N109LFBOX.....	B-38
YAD27M10E38.....	B-7	YAE10N110LFBOX.....	B-38	YAE14N1BOX.....	B-11
YAD27M12E12.....	B-7	YAE10N111BFBOX.....	B-42	YAE14N1M.....	B-11
YAD27M16E58.....	B-7	YAE10N111LFBOX.....	B-38	YAE14N2.....	B-11
YAD27M20E34.....	B-7	YAE10N112BFBOX.....	B-42	YAE14N2BOX.....	B-11
YAD27M8E516.....	B-7	YAE10N112LFBOX.....	B-38	YAE14N2M.....	B-11
YAD28M10E38.....	B-7	YAE10N11BOX.....	B-11	YAE14N3.....	B-11
YAD28M12E12.....	B-7	YAE10N11M.....	B-11	YAE14N3BOX.....	B-11
YAD28M16E58.....	B-7	YAE10N2.....	B-11	YAE14N3M.....	B-11
YAD28M20E34.....	B-7	YAE10N2BOX.....	B-11	YAE14N4.....	B-11
YAD28M6E14.....	B-7	YAE10N2M.....	B-11	YAE14N43.....	B-11
YAD28M8E516.....	B-7	YAE10N3.....	B-11	YAE14N43BOX.....	B-11
YAD2CM10E38.....	B-6	YAE10N3BOX.....	B-11	YAE14N43M.....	B-11
YAD2CM12E12.....	B-6	YAE10N3M.....	B-11	YAE14N4BOX.....	B-11
YAD2CM16E58.....	B-6	YAE10N4.....	B-11	YAE14N4M.....	B-11
YAD2CM20E34.....	B-6	YAE10N4BOX.....	B-11	YAE14N76F.....	B-33
YAD2CM6E14.....	B-6	YAE10N4M.....	B-11	YAE14N76FBOX.....	B-33
YAD2CM8E516.....	B-6	YAE10N5.....	B-11	YAE14N77F.....	B-33
YAD30M10E38.....	B-7	YAE10N5BOX.....	B-11	YAE14N77FBOX.....	B-33
YAD30M12E12.....	B-7	YAE10N5M.....	B-11	YAE14N77FM.....	B-33
YAD30M16E58.....	B-7	YAE10N79BOX.....	B-11	YAE14N78F.....	B-33
YAD30M20E34.....	B-7	YAE10N80FBOX.....	B-33	YAE14N78FBOX.....	B-33
YAD31M10E38.....	B-7	YAE10N81FBOX.....	B-33	YAE14N78FM.....	B-33
YAD31M12E12.....	B-7	YAE10N82FBOX.....	B-33	YAE14NBOX.....	B-11
YAD31M16E58.....	B-7	YAE10N83FBOX.....	B-33	YAE14NM.....	B-11
YAD31M20E34.....	B-7	YAE10NBOX.....	B-11	YAE14Z2.....	B-46
YAD33M10E38.....	B-7	YAE10NM.....	B-11	YAE14Z2BOX.....	B-46
YAD33M12E12.....	B-7	YAE12N.....	B-11	YAE14Z3.....	B-46
YAD33M16E58.....	B-7	YAE12N1.....	B-11	YAE14Z3BOX.....	B-46
YAD33M20E34.....	B-7	YAE12N1BOX.....	B-11	YAE14Z4.....	B-46

ALPHA-NUMERIC INDEX BY CATALOG NUMBER

YAE14Z4BOX	B-46	YAE22G14BOX	B-10	YAEBAS26PTN	C-233
YAE18G43F	B-33	YAE22G15	B-10	YAEBAS26PTNOEM	C-233
YAE18G43FBOX	B-33	YAE22G15BOX	B-10	YAEBAS27NTN	C-233
YAE18G43FM	B-33	YAE22G16	B-10	YAEBAS27NTNOEM	C-233
YAE18N	B-11	YAE22G16BOX	B-10	YAEBAS27PTN	C-233
YAE18N1	B-11	YAE22G16M	B-10	YAEBAS27PTNOEM	C-233
YAE18N104BFBOX	B-42	YAE22G18	B-10	YAEBAS28NTN	C-233
YAE18N104LFBOX	B-38	YAE22G18BOX	B-10	YAEBAS28NTNOEM	C-233
YAE18N105BFBOX	B-42	YAE22G18M	B-10	YAEBAS28PTN	C-233
YAE18N105LFBOX	B-38	YAE22N65F	B-33	YAEBAS28PTNOEM	C-233
YAE18N106BFBOX	B-42	YAE22N65FBOX	B-33	YAEBAS2CNTN	C-233
YAE18N106LFBOX	B-38	YAE22N65FM	B-33	YAEBAS2CNTNOEM	C-233
YAE18N15	B-11	YAE22N66F	B-33	YAEBAS2CPTN	C-233
YAE18N15BOX	B-11	YAE22N66FBOX	B-33	YAEBAS2CPTNOEM	C-233
YAE18N15M	B-11	YAE22N66FM	B-33	YAEBAS4CNTN	C-233
YAE18N1BOX	B-11	YAE22Z1	B-46	YAEBAS4CNTNOEM	C-233
YAE18N2	B-11	YAE22Z1BOX	B-46	YAEBAS4CPTN	C-233
YAE18N21	B-11	YAE22Z2	B-46	YAEBAS4CPTNOEM	C-233
YAE18N21BOX	B-11	YAE22Z2BOX	B-46	YAEBAS6CNTN	C-233
YAE18N21M	B-11	YAE22Z3	B-46	YAEBAS6CNTNOEM	C-233
YAE18N24	B-11	YAE22Z3BOX	B-46	YAEBAS6CPTN	C-233
YAE18N24BOX	B-11	YAEBAF1CNTN	C-234	YAEBAS6CPTNOEM	C-233
YAE18N24M	B-11	YAEBAF1CNTNOEM	C-234	YAES10K11	B-14
YAE18N26	B-11	YAEBAF1CPTN	C-234	YAES10K11T1	B-14
YAE18N26BOX	B-11	YAEBAF1CPTNOEM	C-234	YAES10K12	B-14
YAE18N26M	B-11	YAEBAF25NTN	C-234	YAES10K13	B-14
YAE18N2BOX	B-11	YAEBAF25NTNOEM	C-234	YAES10K14	B-14
YAE18N2M	B-11	YAEBAF25PTN	C-234	YAES10K56	B-14
YAE18N3	B-11	YAEBAF25PTNOEM	C-234	YAES10K57	B-14
YAE18N3BOX	B-11	YAEBAF26NTN	C-234	YAES10K58	B-14
YAE18N3M	B-11	YAEBAF26NTNOEM	C-234	YAES10N11	B-9
YAE18N56F	B-33	YAEBAF26PTN	C-234	YAES10N11F	B-32
YAE18N56FBOX	B-33	YAEBAF26PTNOEM	C-234	YAES10N12	B-9
YAE18N57F	B-33	YAEBAF27NTN	C-234	YAES10N12F	B-32
YAE18N57FBOX	B-33	YAEBAF27NTNOEM	C-234	YAES10N13	B-9
YAE18N57FM	B-33	YAEBAF27PTN	C-234	YAES10N14	B-9
YAE18N58FBOX	B-33	YAEBAF27PTNOEM	C-234	YAES10N56	B-9
YAE18N60F	B-33	YAEBAF28NTN	C-234	YAES10N56F	B-32
YAE18N60FBOX	B-33	YAEBAF28NTNOEM	C-234	YAES10N57	B-9
YAE18NBOX	B-11	YAEBAF28PTN	C-234	YAES10N57F	B-32
YAE18NM	B-11	YAEBAF28PTNOEM	C-234	YAES10N58	B-9
YAE18Z1	B-46	YAEBAF2CNTN	C-234	YAES14K10	B-14
YAE18Z1BOX	B-46	YAEBAF2CNTNOEM	C-234	YAES14K53	B-14
YAE18Z2	B-46	YAEBAF2CPTN	C-234	YAES14K54	B-14
YAE18Z2BOX	B-46	YAEBAF2CPTNOEM	C-234	YAES14K6	B-14
YAE18Z3	B-46	YAEBAS1CNTN	C-233	YAES14K7	B-14
YAE18Z3BOX	B-46	YAEBAS1CNTNOEM	C-233	YAES14K8	B-14
YAE18Z4	B-46	YAEBAS1CPTN	C-233	YAES14K9	B-14
YAE18Z4BOX	B-46	YAEBAS1CPTNOEM	C-233	YAES14N10	B-9
YAE22G12	B-10	YAEBAS25NTN	C-233	YAES14N52	B-9
YAE22G12BOX	B-10	YAEBAS25NTNOEM	C-233	YAES14N53	B-9
YAE22G13	B-10	YAEBAS25PTN	C-233	YAES14N53F	B-32
YAE22G13BOX	B-10	YAEBAS25PTNOEM	C-233	YAES14N54	B-9
YAE22G13M	B-10	YAEBAS26NTN	C-233	YAES14N54F	B-32
YAE22G14	B-10	YAEBAS26NTNOEM	C-233	YAES14N6	B-9

ALPHA-NUMERIC INDEX BY CATALOG NUMBER

YAES14N6F.....	B-32	YAEV26L.....	B-25	YAG1CLTC38FX.....	C-72
YAES14N7.....	B-9	YAEV26L1.....	B-25	YAG1CLTC516FX.....	C-72
YAES14N8.....	B-9	YAEV26L2.....	B-25	YAG1CLTC516FXTZ.....	C-79
YAES14N8F.....	B-32	YAEV26L3.....	B-25	YAG25LTC12FX.....	C-72
YAES14N9.....	B-9	YAEV26L3BOX.....	B-25	YAG25LTC12FXTZ.....	C-79
YAES18K1.....	B-14	YAEV26LBOX.....	B-25	YAG25LTC14FX.....	C-72
YAES18K2.....	B-14	YAEV26RS.....	B-27	YAG25LTC38FX.....	C-72
YAES18K3.....	B-14	YAEV2CL.....	B-25	YAG25LTC38FXTZ.....	C-79
YAES18K4.....	B-14	YAEV2CL1.....	B-25	YAG25LTC516FX.....	C-72
YAES18K49.....	B-14	YAEV2CL1BOX.....	B-25	YAG26L2NTCFXTZ.....	C-89
YAES18K5.....	B-14	YAEV2CL2.....	B-25	YAG26LTC12FX.....	C-72
YAES18K50.....	B-14	YAEV2CL2BOX.....	B-25	YAG26LTC12FXTZ.....	C-79
YAES18N1.....	B-9	YAEV2CL3.....	B-25	YAG26LTC14FX.....	C-72
YAES18N1F.....	B-32	YAEV2CL3BOX.....	B-25	YAG26LTC38FX.....	C-72
YAES18N2.....	B-9	YAEV2CL4.....	B-25	YAG26LTC38FXTZ.....	C-79
YAES18N3.....	B-9	YAEV2CLBOX.....	B-25	YAG26LTC516FX.....	C-72
YAES18N3F.....	B-32	YAEV2CRS.....	B-27	YAG26LTC516FXTZ.....	C-79
YAES18N4.....	B-9	YAEV2CRS1.....	B-27	YAG27L2NTCFXTZ.....	C-89
YAES18N48.....	B-9	YAEV4CL.....	B-25	YAG27LTC12FX.....	C-72
YAES18N49.....	B-9	YAEV4CL2.....	B-25	YAG27LTC12FXTZ.....	C-79
YAES18N49F.....	B-32	YAEV4CL3.....	B-25	YAG27LTC14FX.....	C-72
YAES18N5.....	B-9	YAEV4CL3BOX.....	B-25	YAG27LTC14FXTZ.....	C-79
YAES18N50.....	B-9	YAEV4CL4.....	B-25	YAG27LTC38FX.....	C-72
YAES18N50F.....	B-32	YAEV4CL4BOX.....	B-25	YAG27LTC38FXTZ.....	C-79
YAEV10.....	B-24	YAEV4CL5.....	B-25	YAG27LTC516FX.....	C-72
YAEV10BOX.....	B-24	YAEV4CLBOX.....	B-25	YAG27LTC516FXTZ.....	C-89
YAEV10L36.....	B-24	YAEV4CRS.....	B-27	YAG28L2NTCFXTZ.....	C-89
YAEV10L36BOX.....	B-24	YAEV4CRS2.....	B-27	YAG28L2TC38FXDTTZ.....	C-89
YAEV10T11.....	B-24	YAEV6CL.....	B-25	YAG28L2TC38FXTZ.....	C-89
YAEV10T11BOX.....	B-24	YAEV6CL1.....	B-25	YAG28L2TC516FXTZ.....	C-89
YAEV10T2.....	B-24	YAEV6CL10.....	B-25	YAG28LTC12FX.....	C-73
YAEV10T2BOX.....	B-24	YAEV6CL10BOX.....	B-25	YAG28LTC12FXTZ.....	C-79
YAEV10T3.....	B-24	YAEV6CL1BOX.....	B-25	YAG28LTC14FX.....	C-73
YAEV10T3BOX.....	B-24	YAEV6CL2.....	B-25	YAG28LTC14FXTZ.....	C-79
YAEV10T4.....	B-24	YAEV6CL4.....	B-25	YAG28LTC38FX.....	C-73
YAEV10T4BOX.....	B-24	YAEV6CL4BOX.....	B-25	YAG28LTC38FXTZ.....	C-79
YAEV10T7.....	B-24	YAEV6CLBOX.....	B-25	YAG28LTC516FX.....	C-73
YAEV10T7BOX.....	B-24	YAEV6CRS.....	B-27	YAG28LTC516FXTZ.....	C-79
YAEV14.....	B-24	YAEV6CRS1.....	B-27	YAG28LTC516N66FXTZ.....	C-79
YAEV14BOX.....	B-24	YAEV8CL.....	B-25	YAG28LTC58FXTZ.....	C-79
YAEV18.....	B-24	YAEV8CL1.....	B-25	YAG29L2NT38FX90TZ.....	C-89
YAEV18BOX.....	B-24	YAEV8CL14.....	B-25	YAG29L2NT38FXTZ.....	C-89
YAEV1CL.....	B-25	YAEV8CL14BOX.....	B-25	YAG29L2NTCFXTZ.....	C-89
YAEV1CL1.....	B-25	YAEV8CL1BOX.....	B-25	YAG29L2TC38FXTZ.....	C-89
YAEV1CL2.....	B-25	YAEV8CL2.....	B-25	YAG29LTC12FX.....	C-73
YAEV1CL3.....	B-25	YAEV8CL2BOX.....	B-25	YAG29LTC38FX.....	C-73
YAEV1CLBOX.....	B-25	YAEV8CL3.....	B-25	YAG29LTC38FXTZ.....	C-80
YAEV1CRS.....	B-27	YAEV8CL3BOX.....	B-25	YAG29LTC516FXTZ.....	C-80
YAEV1CRS2.....	B-27	YAEV8CL4.....	B-25	YAG29LTC58FX.....	C-73
YAEV25L.....	B-25	YAEV8CL4BOX.....	B-25	YAG2CL2NTCFXTZ.....	C-89
YAEV25L1.....	B-25	YAEV8CLBOX.....	B-25	YAG2CL2TC14FXTZ.....	C-89
YAEV25L2.....	B-25	YAEV8CRS.....	B-27	YAG2CLTC12FX.....	C-72
YAEV25L3.....	B-25	YAEV8CRS1.....	B-27	YAG2CLTC12FXTZ.....	C-79
YAEV25L4.....	B-25	YAG1CLTC12FX.....	C-72	YAG2CLTC14FX.....	C-72
YAEV25RS.....	B-27	YAG1CLTC14FX.....	C-72	YAG2CLTC14FXTZ.....	C-79

ALPHA-NUMERIC INDEX BY CATALOG NUMBER

YAG2CLTC38FX.....	C-72	YAG6CLTC38FXTZ.....	C-79	YAGB6CLTC10FXOEM.....	C-235
YAG2CLTC38FXTZ.....	C-79	YAG6CLTC516FX.....	C-72	YAGB6CLTC12FX.....	C-235
YAG2CLTC516FX.....	C-72	YAG6CLTC516FXTZ.....	C-79	YAGB6CLTC12FXOEM.....	C-235
YAG2CLTC516FXTZ.....	C-79	YAG8CL2TC14E1FXTZ.....	C-89	YAGB6CLTC14FX.....	C-235
YAG30LTC12FX.....	C-73	YAG8CL2TC14FXTZ.....	C-89	YAGB6CLTC14FXOEM.....	C-235
YAG30LTC38FX.....	C-73	YAG8CLTC12FX.....	C-72	YAGB6CLTC38FX.....	C-235
YAG30LTC58FX.....	C-73	YAG8CLTC14FX.....	C-72	YAGB6CLTC38FXOEM.....	C-235
YAG31L2NTC38FXTZ.....	C-89	YAG8CLTC14FXTZ.....	C-79	YAGB6CLTC516FX.....	C-235
YAG31LTC12FX.....	C-73	YAG8CLTC38FXTZ.....	C-79	YAGB6CLTC516FXOEM.....	C-235
YAG31LTC14FX.....	C-73	YAG8CLTC516FX.....	C-72	YAIT1210Y.....	B-70
YAG31LTC38FX.....	C-73	YAGB25LTC12FX.....	C-235	YAIT1814B.....	B-70
YAG31LTC516FX.....	C-73	YAGB25LTC12FXOEM.....	C-235	YAIT2218R.....	B-70
YAG31LTC58FX.....	C-73	YAGB25LTC14FX.....	C-235	YAK25A2G1.....	H-81
YAG32LTC12FX.....	C-73	YAGB25LTC14FXOEM.....	C-235	YAK25A2G2.....	H-81
YAG32LTC58FX.....	C-73	YAGB25LTC38FX.....	C-235	YAK28A2G1.....	H-81
YAG32LTC58FXTZ.....	C-80	YAGB25LTC38FXOEM.....	C-235	YAK28A2G2.....	H-81
YAG34L2NTCFXTZ.....	C-89	YAGB25LTC516FX.....	C-235	YAK29A2G1.....	H-81
YAG34L2TC38FXTZ.....	C-89	YAGB25LTC516FXOEM.....	C-235	YAK2CA2G1.....	H-81
YAG34LTC12FX.....	C-73	YAGB26LTC12FX.....	C-235	YAK2CA2G2.....	H-81
YAG34LTC12FXTZ.....	C-80	YAGB26LTC12FXOEM.....	C-235	YAK311A2G1.....	H-81
YAG34LTC38FX.....	C-73	YAGB26LTC14FX.....	C-235	YAK311A2G2.....	H-81
YAG34LTC38FXTZ.....	C-80	YAGB26LTC14FXOEM.....	C-235	YAK31A2G1.....	H-81
YAG34LTC516FX.....	C-73	YAGB26LTC38FX.....	C-235	YAK31A2G2.....	H-81
YAG34LTC516FXTZ.....	C-80	YAGB26LTC38FXOEM.....	C-235	YAK34A2G1.....	H-81
YAG34LTC516N66FXTZ.....	C-80	YAGB26LTC516FX.....	C-235	YAK34A2G2.....	H-81
YAG34LTC58FX.....	C-73	YAGB26LTC516FXOEM.....	C-235	YAK361A2G1.....	H-81
YAG36LTC38FX.....	C-73	YAGB28LTC12FX.....	C-235	YAK361A2G2.....	H-81
YAG38L2NTCFXTZ.....	C-90	YAGB28LTC12FXOEM.....	C-235	YAK39A2G1.....	H-81
YAG38L2TC12FXTZ.....	C-90	YAGB28LTC14FX.....	C-235	YAK39A2G2.....	H-81
YAG38LTC12FX.....	C-73	YAGB28LTC14FXOEM.....	C-235	YAK44A2NG7.....	H-81
YAG38LTC38FX.....	C-73	YAGB28LTC38FX.....	C-235	YAK44A2NG8.....	H-81
YAG38LTC516FX.....	C-73	YAGB28LTC38FXOEM.....	C-235	YALB102M10.....	C-141
YAG38LTC58FXTZ.....	C-80	YAGB28LTC516FX.....	C-235	YALB102M12.....	C-141
YAG40L2NNTFXTZ.....	C-90	YAGB28LTC516FXOEM.....	C-235	YALB102M4.....	C-141
YAG40LTC12FX.....	C-73	YAGB2CLTC10FX.....	C-235	YALB102M5.....	C-141
YAG40LTC12FXTZ.....	C-80	YAGB2CLTC10FXOEM.....	C-235	YALB102M6.....	C-141
YAG40LTC38FX.....	C-73	YAGB2CLTC12FX.....	C-235	YALB102M8.....	C-141
YAG40LTC516FX.....	C-73	YAGB2CLTC12FXOEM.....	C-235	YALB10M10.....	C-138
YAG44L2NTCFXTZ.....	C-90	YAGB2CLTC14FX.....	C-235	YALB10M12.....	C-138
YAG44L2TC38FXTZ.....	C-90	YAGB2CLTC14FXOEM.....	C-235	YALB10M4.....	C-138
YAG44LTC12FX.....	C-73	YAGB2CLTC38FX.....	C-235	YALB10M5.....	C-138
YAG4CL2TC14FXTZ.....	C-89	YAGB2CLTC38FXOEM.....	C-235	YALB10M6.....	C-138
YAG4CLTC12FX.....	C-72	YAGB2CLTC516FX.....	C-235	YALB10M8.....	C-138
YAG4CLTC14FX.....	C-72	YAGB2CLTC516FXOEM.....	C-235	YALB1202M10.....	C-142
YAG4CLTC14FXTZ.....	C-79	YAGB4CLTC10FX.....	C-235	YALB1202M12.....	C-142
YAG4CLTC38FX.....	C-72	YAGB4CLTC10FXOEM.....	C-235	YALB1202M14.....	C-142
YAG4CLTC38FXTZ.....	C-79	YAGB4CLTC12FX.....	C-235	YALB1202M16.....	C-142
YAG4CLTC516FX.....	C-72	YAGB4CLTC12FXOEM.....	C-235	YALB1202M20.....	C-142
YAG4CLTC516FXTZ.....	C-79	YAGB4CLTC14FX.....	C-235	YALB1202M8.....	C-142
YAG6CL2TC14FXTZ.....	C-89	YAGB4CLTC14FXOEM.....	C-235	YALB120F2M10.....	C-154
YAG6CLTC12FX.....	C-72	YAGB4CLTC38FX.....	C-235	YALB120F2M12.....	C-154
YAG6CLTC12FXTZ.....	C-79	YAGB4CLTC38FXOEM.....	C-235	YALB120F2M14.....	C-154
YAG6CLTC14FX.....	C-72	YAGB4CLTC516FX.....	C-235	YALB120F2M16.....	C-154
YAG6CLTC14FXTZ.....	C-79	YAGB4CLTC516FXOEM.....	C-235	YALB120F2M20.....	C-154
YAG6CLTC38FX.....	C-72	YAGB6CLTC10FX.....	C-235	YALB120F2M8.....	C-154

ALPHA-NUMERIC INDEX BY CATALOG NUMBER

YALB120FM10.....	C-151	YALB185F2M12.....	C-155	YALB300F2M16.....	C-155
YALB120FM12.....	C-151	YALB185F2M14.....	C-155	YALB300F2M20.....	C-155
YALB120FM14.....	C-151	YALB185F2M16.....	C-155	YALB300FM10.....	C-152
YALB120FM16.....	C-151	YALB185F2M20.....	C-155	YALB300FM12.....	C-152
YALB120FM20.....	C-151	YALB185F2M8.....	C-155	YALB300FM14.....	C-152
YALB120FM8.....	C-151	YALB185FM10.....	C-152	YALB300FM16.....	C-152
YALB120M10.....	C-139	YALB185FM12.....	C-152	YALB300FM20.....	C-152
YALB120M12.....	C-139	YALB185FM14.....	C-152	YALB300M10.....	C-139
YALB120M14.....	C-139	YALB185FM16.....	C-152	YALB300M12.....	C-139
YALB120M16.....	C-139	YALB185FM20.....	C-152	YALB300M14.....	C-139
YALB120M20.....	C-139	YALB185FM8.....	C-152	YALB300M16.....	C-139
YALB120M8.....	C-139	YALB185M10.....	C-139	YALB300M20.....	C-139
YALB1502M10.....	C-142	YALB185M12.....	C-139	YALB352M10.....	C-141
YALB1502M12.....	C-142	YALB185M14.....	C-139	YALB352M12.....	C-141
YALB1502M14.....	C-142	YALB185M16.....	C-139	YALB352M5.....	C-141
YALB1502M16.....	C-142	YALB185M20.....	C-139	YALB352M6.....	C-141
YALB1502M20.....	C-142	YALB185M8.....	C-139	YALB352M8.....	C-141
YALB1502M8.....	C-142	YALB2402M10.....	C-143	YALB35M10.....	C-138
YALB150F2M10.....	C-154	YALB2402M12.....	C-143	YALB35M12.....	C-138
YALB150F2M12.....	C-154	YALB2402M14.....	C-143	YALB35M5.....	C-138
YALB150F2M14.....	C-154	YALB2402M16.....	C-143	YALB35M6.....	C-138
YALB150F2M16.....	C-154	YALB2402M20.....	C-143	YALB35M8.....	C-138
YALB150F2M20.....	C-154	YALB240F2M10.....	C-155	YALB4002M12.....	C-143
YALB150F2M8.....	C-154	YALB240F2M12.....	C-155	YALB4002M14.....	C-143
YALB150FM10.....	C-151	YALB240F2M14.....	C-155	YALB4002M16.....	C-143
YALB150FM12.....	C-151	YALB240F2M16.....	C-155	YALB4002M20.....	C-143
YALB150FM14.....	C-151	YALB240F2M20.....	C-155	YALB400F2M12.....	C-155
YALB150FM16.....	C-151	YALB240FM10.....	C-152	YALB400F2M14.....	C-155
YALB150FM20.....	C-151	YALB240FM12.....	C-152	YALB400F2M16.....	C-155
YALB150FM8.....	C-151	YALB240FM14.....	C-152	YALB400F2M20.....	C-155
YALB150M10.....	C-139	YALB240FM16.....	C-152	YALB400FM12.....	C-152
YALB150M12.....	C-139	YALB240FM20.....	C-152	YALB400FM14.....	C-152
YALB150M14.....	C-139	YALB240M10.....	C-139	YALB400FM16.....	C-152
YALB150M16.....	C-139	YALB240M12.....	C-139	YALB400FM20.....	C-152
YALB150M20.....	C-139	YALB240M14.....	C-139	YALB400M12.....	C-139
YALB150M8.....	C-139	YALB240M16.....	C-139	YALB400M14.....	C-139
YALB162M10.....	C-141	YALB240M20.....	C-139	YALB400M16.....	C-139
YALB162M12.....	C-141	YALB252M10.....	C-141	YALB400M20.....	C-139
YALB162M4.....	C-141	YALB252M12.....	C-141	YALB5002M12.....	C-143
YALB162M5.....	C-141	YALB252M5.....	C-141	YALB5002M16.....	C-143
YALB162M6.....	C-141	YALB252M6.....	C-141	YALB5002M20.....	C-143
YALB162M8.....	C-141	YALB252M8.....	C-141	YALB500F2M12.....	C-155
YALB16M10.....	C-138	YALB25M10.....	C-138	YALB500F2M16.....	C-155
YALB16M12.....	C-138	YALB25M12.....	C-138	YALB500F2M20.....	C-155
YALB16M4.....	C-138	YALB25M5.....	C-138	YALB500FM12.....	C-152
YALB16M5.....	C-138	YALB25M6.....	C-138	YALB500FM16.....	C-152
YALB16M6.....	C-138	YALB25M8.....	C-138	YALB500FM20.....	C-152
YALB16M8.....	C-138	YALB3002M10.....	C-143	YALB500M12.....	C-139
YALB1852M10.....	C-142	YALB3002M12.....	C-143	YALB500M16.....	C-139
YALB1852M12.....	C-142	YALB3002M14.....	C-143	YALB500M20.....	C-139
YALB1852M14.....	C-142	YALB3002M16.....	C-143	YALB502M10.....	C-141
YALB1852M16.....	C-142	YALB3002M20.....	C-143	YALB502M12.....	C-141
YALB1852M20.....	C-142	YALB300F2M10.....	C-155	YALB502M14.....	C-141
YALB1852M8.....	C-142	YALB300F2M12.....	C-155	YALB502M16.....	C-141
YALB185F2M10.....	C-155	YALB300F2M14.....	C-155	YALB502M6.....	C-141

ALPHA-NUMERIC INDEX BY CATALOG NUMBER

YALB502M8.....	C-141	YALB952M10.....	C-142	YAV10265.....	B-16
YALB50F2M10.....	C-154	YALB952M12.....	C-142	YAV1026545.....	B-16
YALB50F2M12.....	C-154	YALB952M14.....	C-142	YAV1026590.....	B-16
YALB50F2M14.....	C-154	YALB952M16.....	C-142	YAV10266.....	B-16
YALB50F2M16.....	C-154	YALB952M20.....	C-142	YAV1026645.....	B-16
YALB50F2M6.....	C-154	YALB952M8.....	C-142	YAV1026690.....	B-16
YALB50F2M8.....	C-154	YALB95F2M10.....	C-154	YAV10270.....	B-16
YALB50FM10.....	C-151	YALB95F2M12.....	C-154	YAV1027045.....	B-16
YALB50FM12.....	C-151	YALB95F2M14.....	C-154	YAV1027090.....	B-16
YALB50FM14.....	C-151	YALB95F2M16.....	C-154	YAV102M10.....	C-135
YALB50FM16.....	C-151	YALB95F2M20.....	C-154	YAV102M12.....	C-135
YALB50FM6.....	C-151	YALB95F2M8.....	C-154	YAV102M4.....	C-135
YALB50FM8.....	C-151	YALB95FM10.....	C-151	YAV102M5.....	C-135
YALB50M10.....	C-138	YALB95FM12.....	C-151	YAV102M6.....	C-135
YALB50M12.....	C-138	YALB95FM14.....	C-151	YAV102M8.....	C-135
YALB50M14.....	C-138	YALB95FM16.....	C-151	YAV102TC10.....	C-22
YALB50M16.....	C-138	YALB95FM20.....	C-151	YAV102TC1090SL.....	C-112
YALB50M6.....	C-138	YALB95FM8.....	C-151	YAV102TC10E2.....	C-22
YALB50M8.....	C-138	YALB95M10.....	C-138	YAV102TC14.....	C-22
YALB6302M12.....	C-143	YALB95M12.....	C-138	YAV102TC14E1.....	C-22
YALB6302M16.....	C-143	YALB95M14.....	C-138	YAV102TC14E2.....	C-22
YALB6302M20.....	C-143	YALB95M16.....	C-138	YAV102TC38.....	C-22
YALB630F2M12.....	C-155	YALB95M20.....	C-138	YAV10BOX.....	B-20, C-14
YALB630F2M16.....	C-155	YALB95M8.....	C-138	YAV10H.....	B-23
YALB630F2M20.....	C-155	YAV0252M3.....	C-135	YAV10H25.....	B-23
YALB630FM12.....	C-152	YAV0252M4.....	C-135	YAV10H25BOX.....	B-23
YALB630FM16.....	C-152	YAV0252M5.....	C-135	YAV10H3.....	B-23
YALB630FM20.....	C-152	YAV0252M6.....	C-135	YAV10H3BOX.....	B-23
YALB630M12.....	C-139	YAV0252M8.....	C-135	YAV10HBOX.....	B-23
YALB630M16.....	C-139	YAV025M3.....	C-131	YAV10HF.....	B-44
YALB630M20.....	C-139	YAV025M4.....	C-131	YAV10HFBOX.....	B-44
YALB702M10.....	C-142	YAV025M5.....	C-131	YAV10L36.....	B-20
YALB702M12.....	C-142	YAV025M6.....	C-131	YAV10L36BOX.....	B-20
YALB702M14.....	C-142	YAV025M8.....	C-131	YAV10M10.....	C-131
YALB702M16.....	C-142	YAV062M10.....	C-135	YAV10M12.....	C-131
YALB702M6.....	C-142	YAV062M4.....	C-135	YAV10M4.....	C-131
YALB702M8.....	C-142	YAV062M5.....	C-135	YAV10M5.....	C-131
YALB70F2M10.....	C-154	YAV062M6.....	C-135	YAV10M6.....	C-131
YALB70F2M12.....	C-154	YAV062M8.....	C-135	YAV10M8.....	C-131
YALB70F2M14.....	C-154	YAV06M10.....	C-131	YAV10R.....	B-26
YALB70F2M16.....	C-154	YAV06M35.....	C-131	YAV10R3BOX.....	B-26
YALB70F2M6.....	C-154	YAV06M4.....	C-131	YAV10T11.....	B-20
YALB70F2M8.....	C-154	YAV06M5.....	C-131	YAV10T11BOX.....	B-20
YALB70FM10.....	C-151	YAV06M6.....	C-131	YAV10T2.....	B-20
YALB70FM12.....	C-151	YAV06M8.....	C-131	YAV10T21F.....	B-30
YALB70FM14.....	C-151	YAV10.....	B-20	YAV10T21FBOX.....	B-30
YALB70FM16.....	C-151	YAV10205.....	B-16	YAV10T23F.....	B-30
YALB70FM6.....	C-151	YAV1020545.....	B-16	YAV10T23FBOX.....	B-30
YALB70FM8.....	C-151	YAV1020590.....	B-16	YAV10T2BOX.....	B-20, C-14
YALB70M10.....	C-138	YAV10206.....	B-16	YAV10T3.....	B-20
YALB70M12.....	C-138	YAV1020645.....	B-16	YAV10T3BOX.....	B-20, C-14
YALB70M14.....	C-138	YAV1020690.....	B-16	YAV10T4.....	B-20
YALB70M16.....	C-138	YAV10228.....	B-16	YAV10T4BOX.....	B-20, C-14
YALB70M6.....	C-138	YAV1022845.....	B-16	YAV10T7.....	B-20
YALB70M8.....	C-138	YAV1022890.....	B-16	YAV10T7BOX.....	B-20

ALPHA-NUMERIC INDEX BY CATALOG NUMBER

YAV1202M10.....	C-136	YAV14T3.....	B-20	YAV185F2M10.....	C-148
YAV1202M12.....	C-136	YAV14T32F.....	B-30	YAV185F2M12.....	C-148
YAV1202M14.....	C-136	YAV14T32FBOX.....	B-30	YAV185F2M14.....	C-148
YAV1202M16.....	C-136	YAV14T34F.....	B-30	YAV185F2M16.....	C-148
YAV1202M20.....	C-136	YAV14T34FBOX.....	B-30	YAV185F2M20.....	C-148
YAV1202M8.....	C-136	YAV14T3BOX.....	B-20	YAV185F2M8.....	C-148
YAV120F2M10.....	C-148	YAV14T5.....	B-20	YAV185FM10.....	C-146
YAV120F2M12.....	C-148	YAV14T5BOX.....	B-20	YAV185FM12.....	C-146
YAV120F2M14.....	C-148	YAV14Z5.....	B-44	YAV185FM14.....	C-146
YAV120F2M16.....	C-148	YAV14Z5BOX.....	B-44	YAV185FM16.....	C-146
YAV120F2M20.....	C-148	YAV14Z6.....	B-44	YAV185FM20.....	C-146
YAV120F2M8.....	C-148	YAV14Z6BOX.....	B-44	YAV185FM8.....	C-146
YAV120FM10.....	C-145	YAV1502M10.....	C-136	YAV185M10.....	C-132
YAV120FM12.....	C-145	YAV1502M12.....	C-136	YAV185M12.....	C-132
YAV120FM14.....	C-145	YAV1502M14.....	C-136	YAV185M14.....	C-132
YAV120FM16.....	C-145	YAV1502M16.....	C-136	YAV185M16.....	C-132
YAV120FM20.....	C-145	YAV1502M20.....	C-136	YAV185M20.....	C-132
YAV120FM8.....	C-145	YAV1502M8.....	C-136	YAV185M8.....	C-132
YAV120M10.....	C-132	YAV150F2M10.....	C-148	YAV18BOX.....	B-20
YAV120M12.....	C-132	YAV150F2M12.....	C-148	YAV18H.....	B-23
YAV120M14.....	C-132	YAV150F2M14.....	C-148	YAV18H19F.....	B-44
YAV120M16.....	C-132	YAV150F2M16.....	C-148	YAV18H19FBOX.....	B-44
YAV120M20.....	C-132	YAV150F2M20.....	C-148	YAV18H21F.....	B-44
YAV120M6.....	C-132	YAV150F2M8.....	C-148	YAV18H21FBOX.....	B-44
YAV120M8.....	C-132	YAV150FM10.....	C-145	YAV18H6F.....	B-44
YAV12G2.....	B-20	YAV150FM12.....	C-145	YAV18H6FBOX.....	B-44
YAV12G2BOX.....	B-20	YAV150FM14.....	C-145	YAV18HBOX.....	B-23
YAV12G3.....	B-20	YAV150FM16.....	C-145	YAV18L33.....	B-20
YAV12G3BOX.....	B-20	YAV150FM20.....	C-145	YAV18L33BOX.....	B-20
YAV14.....	B-20	YAV150FM8.....	C-145	YAV18R.....	B-26
YAV14BOX.....	B-20	YAV150M10.....	C-132	YAV18T1.....	B-20
YAV14H.....	B-23	YAV150M12.....	C-132	YAV18T19F.....	B-30
YAV14H1.....	B-23	YAV150M14.....	C-132	YAV18T19FBOX.....	B-30
YAV14H1BOX.....	B-23	YAV150M16.....	C-132	YAV18T1BOX.....	B-20
YAV14H2.....	B-23	YAV150M20.....	C-132	YAV18T21F.....	B-30
YAV14H2BOX.....	B-23	YAV150M8.....	C-132	YAV18T21FBOX.....	B-30
YAV14H32F.....	B-44	YAV162M10.....	C-135	YAV18T4.....	B-20
YAV14H32FBOX.....	B-44	YAV162M12.....	C-135	YAV18T4BOX.....	B-20
YAV14H34F.....	B-44	YAV162M4.....	C-135	YAV18T5.....	B-20
YAV14H34FBOX.....	B-44	YAV162M5.....	C-135	YAV18T5BOX.....	B-20
YAV14H56F.....	B-44	YAV162M6.....	C-135	YAV1C2NFXB.....	C-107
YAV14H56FBOX.....	B-44	YAV162M8.....	C-135	YAV1C2TC38FXB.....	C-107
YAV14HBOX.....	B-23	YAV16M10.....	C-131	YAV1CL.....	B-22
YAV14HF.....	B-44	YAV16M12.....	C-131	YAV1CL1.....	B-22
YAV14HFBOX.....	B-44	YAV16M4.....	C-131	YAV1CL1BOX.....	B-22
YAV14L33.....	B-20	YAV16M5.....	C-131	YAV1CL2.....	B-22
YAV14L33BOX.....	B-20	YAV16M6.....	C-131	YAV1CL215.....	B-17
YAV14L36.....	B-20	YAV16M8.....	C-131	YAV1CL21545.....	B-17
YAV14L36BOX.....	B-20	YAV18.....	B-20	YAV1CL21590.....	B-17
YAV14R.....	B-26	YAV1852M10.....	C-136	YAV1CL216.....	B-18
YAV14RL33.....	B-26	YAV1852M12.....	C-136	YAV1CL21645.....	B-18
YAV14T1.....	B-20	YAV1852M14.....	C-136	YAV1CL21690.....	B-18
YAV14T1BOX.....	B-20	YAV1852M16.....	C-136	YAV1CL234.....	B-18
YAV14T2.....	B-20	YAV1852M20.....	C-136	YAV1CL23445.....	B-18
YAV14T2BOX.....	B-20	YAV1852M8.....	C-136	YAV1CL23490.....	B-18

ALPHA-NUMERIC INDEX BY CATALOG NUMBER

YAV1CL24590.....	B-17	YAV25L.....	B-22	YAV262NTC38FXB.....	C-107
YAV1CL249.....	B-17	YAV25L1.....	B-22	YAV262TC14E2FXB.....	C-107
YAV1CL24945.....	B-17	YAV25L1BOX.....	B-22	YAV262TC14FXB.....	C-107
YAV1CL250.....	B-18	YAV25L2.....	B-22	YAV262TC38FXB.....	C-107
YAV1CL25045.....	B-18	YAV25L217.....	B-18	YAV26L.....	B-22
YAV1CL25090.....	B-18	YAV25L21745.....	B-18	YAV26L1.....	B-22
YAV1CL2BOX.....	B-22	YAV25L21790.....	B-18	YAV26L12.....	B-22
YAV1CL2NT14FX.....	C-86	YAV25L218.....	B-18	YAV26L12BOX.....	B-22
YAV1CL2NT516FX.....	C-86	YAV25L21845.....	B-18	YAV26L1BOX.....	B-22
YAV1CL2NTCFX.....	C-82	YAV25L21890.....	B-18	YAV26L2.....	B-22
YAV1CL2TC14E1FX.....	C-82	YAV25L235.....	B-18	YAV26L219.....	B-18
YAV1CL2TC14E2FX.....	C-82	YAV25L23545.....	B-18	YAV26L21945.....	B-18
YAV1CL2TC14FX.....	C-82	YAV25L23590.....	B-18	YAV26L21990.....	B-18
YAV1CL2TC38FX.....	C-82	YAV25L251.....	B-18	YAV26L220.....	B-18
YAV1CL2TC516FX.....	C-82	YAV25L25145.....	B-18	YAV26L22045.....	B-18
YAV1CL3.....	B-22	YAV25L25190.....	B-18	YAV26L22090.....	B-18
YAV1CL3BOX.....	B-22	YAV25L252.....	B-18	YAV26L236.....	B-18
YAV1CLBOX.....	B-22	YAV25L25245.....	B-18	YAV26L23645.....	B-18
YAV1CLTC10FX.....	C-68	YAV25L25290.....	B-18	YAV26L23690.....	B-18
YAV1CLTC12FX.....	C-68	YAV25L2BOX.....	B-22	YAV26L253.....	B-18
YAV1CLTC14FX.....	C-68	YAV25L2NT14E1FX.....	C-86	YAV26L25345.....	B-18
YAV1CLTC38FX.....	C-68	YAV25L2NT14FX.....	C-86	YAV26L25390.....	B-18
YAV1CLTC516FX.....	C-68	YAV25L2NT516FX.....	C-86	YAV26L254.....	B-18
YAV1CRS1.....	B-26	YAV25L2NTCFX.....	C-83	YAV26L25445.....	B-18
YAV1CRS2.....	B-26	YAV25L2TC12E1FX.....	C-83	YAV26L25490.....	B-18
YAV1CTC10FXB.....	C-101	YAV25L2TC14E2FX.....	C-83	YAV26L2BOX.....	B-22
YAV1CTC516FXB.....	C-101	YAV25L2TC14FX.....	C-83	YAV26L2NT14FX.....	C-86
YAV2402M10.....	C-136	YAV25L2TC38FX.....	C-83	YAV26L2NT38FX.....	C-86
YAV2402M12.....	C-136	YAV25L2TC516E2FX.....	C-83	YAV26L2NT516FX.....	C-86
YAV2402M14.....	C-136	YAV25L2TC516FX.....	C-83	YAV26L2NTCFX.....	C-83
YAV2402M16.....	C-136	YAV25L3.....	B-22	YAV26L2TC12E1FX.....	C-83
YAV2402M20.....	C-136	YAV25L3BOX.....	B-22	YAV26L2TC14E2FX.....	C-83
YAV240F2M10.....	C-149	YAV25L4.....	B-22	YAV26L2TC14FX.....	C-83
YAV240F2M12.....	C-149	YAV25L4BOX.....	B-22	YAV26L2TC38E10FX.....	C-83
YAV240F2M14.....	C-149	YAV25L4TC14FXG1.....	C-91	YAV26L2TC38FX.....	C-83
YAV240F2M16.....	C-149	YAV25L5BOX.....	B-22	YAV26L2TC516FX.....	C-83
YAV240F2M20.....	C-149	YAV25LNT14FX.....	C-75	YAV26L3.....	B-22
YAV240FM10.....	C-146	YAV25LNT38FX.....	C-75	YAV26L3BOX.....	B-22
YAV240FM12.....	C-146	YAV25LNT516FX.....	C-75	YAV26L4TC14FXG1.....	C-91
YAV240FM14.....	C-146	YAV25LTC12FX.....	C-68	YAV26LBOX.....	B-22
YAV240FM16.....	C-146	YAV25LTC14FX.....	C-68	YAV26LNT12FX.....	C-75
YAV240FM20.....	C-146	YAV25LTC38FX.....	C-68	YAV26LNT38FX.....	C-75
YAV240M10.....	C-132	YAV25LTC516FX.....	C-68	YAV26LNT516FX.....	C-75
YAV240M12.....	C-132	YAV25M10.....	C-131	YAV26LTC10FX.....	C-69
YAV240M14.....	C-132	YAV25M12.....	C-131	YAV26LTC12FX.....	C-69
YAV240M16.....	C-132	YAV25M5.....	C-131	YAV26LTC14FX.....	C-69
YAV240M20.....	C-132	YAV25M6.....	C-131	YAV26LTC34FX.....	C-69
YAV252M10.....	C-135	YAV25M8.....	C-131	YAV26LTC38FX.....	C-69
YAV252M12.....	C-135	YAV25RS.....	B-26	YAV26LTC516FX.....	C-69
YAV252M5.....	C-135	YAV25RS3.....	B-26	YAV26LTC58FX.....	C-69
YAV252M6.....	C-135	YAV25TC10FXB.....	C-101	YAV26RS.....	B-26
YAV252M8.....	C-135	YAV25TC12FXB.....	C-101	YAV26RS3.....	B-26
YAV252TC14E2FXB.....	C-107	YAV25TC38FXB.....	C-101	YAV26TC12FXB.....	C-101
YAV252TC14FXB.....	C-107	YAV25TC38FXB.....	C-101	YAV26TC38FXB.....	C-101
YAV252TC38FXB.....	C-107	YAV25TC516FXB.....	C-101	YAV272NFXB.....	C-107
		YAV262NFXB.....	C-107		

ALPHA-NUMERIC INDEX BY CATALOG NUMBER

YAV272TC14E2FXB.....	C-107	YAV28L25790.....	B-19	YAV2C2NFXB.....	C-107
YAV272TC38FXB.....	C-107	YAV28L258.....	B-19	YAV2C2TC14E1FXB.....	C-107
YAV27L.....	B-22	YAV28L25845.....	B-19	YAV2C2TC14E2FXB.....	C-107
YAV27L1.....	B-22	YAV28L25890.....	B-19	YAV2C2TC14FXB.....	C-107
YAV27L15.....	B-22	YAV28L259.....	B-19	YAV2C2TC38FXB.....	C-107
YAV27L15BOX.....	B-22	YAV28L25945.....	B-19	YAV2C2TC516FXB.....	C-107
YAV27L1BOX.....	B-22	YAV28L25990.....	B-19	YAV2CL.....	B-21
YAV27L221.....	B-18	YAV28L260.....	B-19	YAV2CL1.....	B-21
YAV27L22145.....	B-18	YAV28L26045.....	B-19	YAV2CL1BOX.....	B-21
YAV27L22190.....	B-18	YAV28L26090.....	B-19	YAV2CL2.....	B-21
YAV27L222.....	B-19	YAV28L2ENT14FX.....	C-86	YAV2CL213.....	B-17
YAV27L22245.....	B-19	YAV28L2NT38FX.....	C-86	YAV2CL21345.....	B-17
YAV27L22290.....	B-19	YAV28L2NTCFX.....	C-83	YAV2CL21390.....	B-17
YAV27L255.....	B-18	YAV28L2TC12E1FX.....	C-83	YAV2CL214.....	B-17
YAV27L25545.....	B-18	YAV28L2TC12FX.....	C-83	YAV2CL21445.....	B-17
YAV27L25590.....	B-18	YAV28L2TC14E2FX.....	C-83	YAV2CL21490.....	B-17
YAV27L256.....	B-19	YAV28L2TC14FX.....	C-83	YAV2CL233.....	B-17
YAV27L25645.....	B-19	YAV28L2TC38FX.....	C-83	YAV2CL23345.....	B-17
YAV27L25690.....	B-19	YAV28L2TC516FX.....	C-83	YAV2CL23390.....	B-17
YAV27L2NTCFX.....	C-83	YAV28L4TC14FXG1.....	C-91	YAV2CL246.....	B-17
YAV27L2TC14FX.....	C-83	YAV28L4TCG1.....	C-29	YAV2CL24645.....	B-17
YAV27L2TC38FX.....	C-83	YAV28L53.....	B-22	YAV2CL24690.....	B-17
YAV27L4TC14FXG1.....	C-91	YAV28L53BOX.....	B-22	YAV2CL247.....	B-17
YAV27LBOX.....	B-22	YAV28LBOX.....	B-22	YAV2CL24745.....	B-17
YAV27LNT12FX.....	C-75	YAV28LNT12FX.....	C-75	YAV2CL24790.....	B-17
YAV27LTC10FX.....	C-69	YAV28LNT38FX.....	C-75	YAV2CL248.....	B-17
YAV27LTC12FX.....	C-69	YAV28LNT516FX.....	C-75	YAV2CL24845.....	B-17
YAV27LTC14FX.....	C-69	YAV28LTC12FX.....	C-69	YAV2CL24890.....	B-17
YAV27LTC38FX.....	C-69	YAV28LTC14FX.....	C-69	YAV2CL2BOX.....	B-21
YAV27LTC516FX.....	C-69	YAV28LTC34FX.....	C-69	YAV2CL2NT10FX.....	C-86
YAV27RS.....	B-26	YAV28LTC38FX.....	C-69	YAV2CL2NT14E1FX.....	C-86
YAV27TC12FXB.....	C-101	YAV28LTC516FX.....	C-69	YAV2CL2NT14FX.....	C-86
YAV282NFXB.....	C-108	YAV28LTC58FX.....	C-69	YAV2CL2NTCFX.....	C-82
YAV282NT38FXB.....	C-108	YAV28RS.....	B-26	YAV2CL2TC14E1FX.....	C-82
YAV282NTC38FXB.....	C-108	YAV28TC12FXB.....	C-101	YAV2CL2TC14E2FX.....	C-82
YAV282TC14E2FXB.....	C-108	YAV28TC38FXB.....	C-101	YAV2CL2TC14FX.....	C-82
YAV282TC38FXB.....	C-108	YAV292NFXB.....	C-108	YAV2CL2TC14FXSL.....	C-28, C-87
YAV28L.....	B-22	YAV292NT38FXB.....	C-108	YAV2CL2TC38FX.....	C-82
YAV28L12.....	B-22	YAV292NTC38FXB.....	C-108	YAV2CL2TC38FXSL.....	C-28, C-87
YAV28L12BOX.....	B-22	YAV292TC14E2FXB.....	C-108	YAV2CL2TC516FX.....	C-82
YAV28L13.....	B-22	YAV292TC38FXB.....	C-108	YAV2CL4.....	B-21
YAV28L13BOX.....	B-22	YAV29L2NT38FX.....	C-86	YAV2CL4BOX.....	B-21
YAV28L14.....	B-22	YAV29L2NTCFX.....	C-83	YAV2CL4TC14FXG1.....	C-91
YAV28L14BOX.....	B-22	YAV29L2TC12E1FX.....	C-83	YAV2CLBOX.....	B-21
YAV28L223.....	B-19	YAV29L2TC12FX.....	C-83	YAV2CLNT14FX.....	C-75
YAV28L22345.....	B-19	YAV29L2TC14E2FX.....	C-83	YAV2CLNT516FX.....	C-75
YAV28L22390.....	B-19	YAV29L2TC14FX.....	C-83	YAV2CLTC10FX.....	C-68
YAV28L224.....	B-19	YAV29L2TC38FX.....	C-83	YAV2CLTC12FX.....	C-68
YAV28L22445.....	B-19	YAV29L2TC516FX.....	C-83	YAV2CLTC14FX.....	C-68
YAV28L22490.....	B-19	YAV29LTC12FX.....	C-69	YAV2CLTC38FX.....	C-68
YAV28L237.....	B-19	YAV29LTC14FX.....	C-69	YAV2CLTC516FX.....	C-68
YAV28L23745.....	B-19	YAV29LTC34FX.....	C-69	YAV2CRS.....	B-26
YAV28L23790.....	B-19	YAV29LTC38FX.....	C-69	YAV2CRS1.....	B-26
YAV28L257.....	B-19	YAV29LTC516FX.....	C-69	YAV2CRS2.....	B-26
YAV28L25745.....	B-19	YAV29LTC58FX.....	C-69	YAV2CTC10FXB.....	C-101

ALPHA-NUMERIC INDEX BY CATALOG NUMBER

YAV2CTC516FXB.....	C-101	YAV4CL211.....	B-17	YAV500M12.....	C-133
YAV3002M10.....	C-136	YAV4CL21145.....	B-17	YAV500M16.....	C-133
YAV3002M12.....	C-136	YAV4CL21190.....	B-17	YAV500M20.....	C-133
YAV3002M14.....	C-136	YAV4CL212.....	B-17	YAV502M10.....	C-135
YAV3002M16.....	C-136	YAV4CL21245.....	B-17	YAV502M12.....	C-135
YAV3002M20.....	C-136	YAV4CL21290.....	B-17	YAV502M14.....	C-135
YAV300F2M10.....	C-149	YAV4CL232.....	B-17	YAV502M16.....	C-135
YAV300F2M12.....	C-149	YAV4CL23245.....	B-17	YAV502M6.....	C-135
YAV300F2M14.....	C-149	YAV4CL23290.....	B-17	YAV502M8.....	C-135
YAV300F2M16.....	C-149	YAV4CL244.....	B-17	YAV50F2M10.....	C-148
YAV300F2M20.....	C-149	YAV4CL24445.....	B-17	YAV50F2M12.....	C-148
YAV300FM10.....	C-146	YAV4CL24490.....	B-17	YAV50F2M14.....	C-148
YAV300FM12.....	C-146	YAV4CL245.....	B-17	YAV50F2M16.....	C-148
YAV300FM14.....	C-146	YAV4CL24545.....	B-17	YAV50F2M6.....	C-148
YAV300FM16.....	C-146	YAV4CL24590.....	B-17	YAV50F2M8.....	C-148
YAV300FM20.....	C-146	YAV4CL2BOX.....	B-21	YAV50FM10.....	C-145
YAV300M10.....	C-132	YAV4CL2NT10E1FX.....	C-86	YAV50FM12.....	C-145
YAV300M12.....	C-132	YAV4CL2NT10FX.....	C-86	YAV50FM14.....	C-145
YAV300M14.....	C-132	YAV4CL2NT14FX.....	C-86	YAV50FM16.....	C-145
YAV300M16.....	C-132	YAV4CL2NTCFX.....	C-82	YAV50FM6.....	C-145
YAV300M20.....	C-132	YAV4CL2TC14E1FX.....	C-82	YAV50FM8.....	C-145
YAV352M10.....	C-135	YAV4CL2TC14E2FX.....	C-82	YAV50M10.....	C-131
YAV352M12.....	C-135	YAV4CL2TC14FX.....	C-82	YAV50M12.....	C-131
YAV352M5.....	C-135	YAV4CL2TC14FXSL.....	C-28, C-87	YAV50M14.....	C-131
YAV352M6.....	C-135	YAV4CL2TC38FX.....	C-82	YAV50M16.....	C-131
YAV352M8.....	C-135	YAV4CL2TC38FXSL.....	C-28, C-87	YAV50M5.....	C-131
YAV35M10.....	C-131	YAV4CL2TC516FX.....	C-82	YAV50M6.....	C-131
YAV35M12.....	C-131	YAV4CL3.....	B-21	YAV50M8.....	C-131
YAV35M16.....	C-131	YAV4CL3BOX.....	B-21	YAV6302M16.....	C-136
YAV35M5.....	C-131	YAV4CL4.....	B-21	YAV6302M20.....	C-136
YAV35M6.....	C-131	YAV4CL4BOX.....	B-21	YAV630F2M12.....	C-149
YAV35M8.....	C-131	YAV4CL5.....	B-21	YAV630F2M16.....	C-149
YAV3C2NFXB.....	C-107	YAV4CL5BOX.....	B-21	YAV630F2M20.....	C-149
YAV4002M14.....	C-136	YAV4CLBOX.....	B-21	YAV630FM12.....	C-146
YAV4002M16.....	C-136	YAV4CLNT10FX.....	C-75	YAV630FM16.....	C-146
YAV4002M20.....	C-136	YAV4CLTC10FX.....	C-68	YAV630FM20.....	C-146
YAV400F2M12.....	C-149	YAV4CLTC12FX.....	C-68	YAV630M12.....	C-133
YAV400F2M14.....	C-149	YAV4CLTC14FX.....	C-68	YAV630M16.....	C-133
YAV400F2M16.....	C-149	YAV4CLTC38FX.....	C-68	YAV630M20.....	C-133
YAV400F2M20.....	C-149	YAV4CLTC516FX.....	C-68	YAV6C2NFXB.....	C-107
YAV400FM12.....	C-146	YAV4CRS.....	B-26	YAV6C2TC14E2FXB.....	C-107
YAV400FM14.....	C-146	YAV4CRS2.....	B-26	YAV6C2TC14FXB.....	C-107
YAV400FM16.....	C-146	YAV4CRS3.....	B-26	YAV6C2TC38FXB.....	C-107
YAV400FM20.....	C-146	YAV4CRS4.....	B-26	YAV6CL.....	B-21
YAV400M12.....	C-133	YAV4CTC10FXB.....	C-101	YAV6CL1.....	B-21
YAV400M14.....	C-133	YAV4CTC14FXB.....	C-101	YAV6CL10.....	B-21
YAV400M16.....	C-133	YAV4CTC516FXB.....	C-101	YAV6CL10BOX.....	B-21
YAV400M20.....	C-133	YAV5002M16.....	C-136	YAV6CL1BOX.....	B-21
YAV4C2NFXB.....	C-107	YAV5002M20.....	C-136	YAV6CL2.....	B-21
YAV4C2TC14E2FXB.....	C-107	YAV500F2M12.....	C-149	YAV6CL209.....	B-16
YAV4C2TC14FXB.....	C-107	YAV500F2M16.....	C-149	YAV6CL20945.....	B-16
YAV4C2TC38FXB.....	C-107	YAV500F2M20.....	C-149	YAV6CL20990.....	B-16
YAV4C2TC516FXB.....	C-107	YAV500FM12.....	C-146	YAV6CL210.....	B-17
YAV4CL.....	B-21	YAV500FM16.....	C-146	YAV6CL21045.....	B-17
YAV4CL2.....	B-21	YAV500FM20.....	C-146	YAV6CL21090.....	B-17

ALPHA-NUMERIC INDEX BY CATALOG NUMBER

YAV6CL230.....	B-16	YAV70M14.....	C-132	YAV95M12.....	C-132
YAV6CL23045.....	B-16	YAV70M16.....	C-132	YAV95M14.....	C-132
YAV6CL23090.....	B-16	YAV70M5.....	C-132	YAV95M16.....	C-132
YAV6CL23145.....	B-16	YAV70M6.....	C-132	YAV95M20.....	C-132
YAV6CL23190.....	B-16	YAV70M8.....	C-132	YAV95M6.....	C-132
YAV6CL243.....	B-17	YAV8CL.....	B-21	YAV95M8.....	C-132
YAV6CL24345.....	B-17	YAV8CL1.....	B-21	YAV9CL36.....	B-20
YAV6CL24390.....	B-17	YAV8CL1BOX.....	B-21	YAV9CL36BOX.....	B-20
YAV6CL2BOX.....	B-21	YAV8CL2.....	B-21	YAV9CT4.....	B-20
YAV6CL2NTCFX.....	C-82	YAV8CL207.....	B-16	YAV9CT4BOX.....	B-20
YAV6CL2TC10E2FX.....	C-82	YAV8CL20745.....	B-16	YAV9CT9.....	B-20
YAV6CL2TC10E4FX.....	C-82	YAV8CL20790.....	B-16	YAV9CT9BOX.....	B-20
YAV6CL2TC10E9FX.....	C-82	YAV8CL208.....	B-16	YAZ1C2N.....	C-46
YAV6CL2TC10FX.....	C-82	YAV8CL20845.....	B-16	YAZ1C2TC14.....	C-46
YAV6CL2TC10FX90SL.....	C-28, C-87	YAV8CL20890.....	B-16	YAZ1C2TC14E2.....	C-46
YAV6CL2TC14E1FX.....	C-82	YAV8CL229.....	B-16	YAZ1C2TC38.....	C-46
YAV6CL2TC14E2FX.....	C-82	YAV8CL22945.....	B-16	YAZ1CTC12.....	C-37
YAV6CL2TC14FX.....	C-82	YAV8CL22990.....	B-16	YAZ1CTC14.....	C-37
YAV6CL2TC38FX.....	C-82	YAV8CL240.....	B-16	YAZ1CTC38.....	C-37
YAV6CL2TC516FX.....	C-82	YAV8CL24045.....	B-16	YAZ252N.....	C-46
YAV6CL4.....	B-21	YAV8CL24090.....	B-16	YAZ252NTC38.....	C-46
YAV6CL4BOX.....	B-21	YAV8CL241.....	B-16	YAZ252TC14.....	C-46
YAV6CLBOX.....	B-21	YAV8CL24145.....	B-16	YAZ252TC14E1.....	C-46
YAV6CLTC10FX.....	C-68	YAV8CL24190.....	B-16	YAZ252TC14E2.....	C-46
YAV6CLTC12FX.....	C-68	YAV8CL242.....	B-16	YAZ252TC14E3.....	C-46
YAV6CLTC14FX.....	C-68	YAV8CL24245.....	B-16	YAZ252TC38.....	C-46
YAV6CLTC34FX.....	C-68	YAV8CL24290.....	B-16	YAZ252TC516.....	C-46
YAV6CLTC38FX.....	C-68	YAV8CL2BOX.....	B-21	YAZ252TC516E6.....	C-46
YAV6CLTC516FX.....	C-68	YAV8CL3.....	B-21	YAZ254TC38E1G1.....	C-58, C-92
YAV6CRS.....	B-26	YAV8CL3BOX.....	B-21	YAZ254TCG1.....	C-58, C-92
YAV6CRS1.....	B-26	YAV8CL4.....	B-21	YAZ25TC12.....	C-37
YAV6CRS2.....	B-26	YAV8CL4BOX.....	B-21	YAZ25TC14.....	C-37
YAV6CRS4.....	B-26	YAV8CLBOX.....	B-21	YAZ25TC38.....	C-37
YAV6CTC10FXB.....	C-101	YAV8CRS.....	B-26	YAZ25TC516.....	C-37
YAV6CTC14FXB.....	C-101	YAV8CRS1.....	B-26	YAZ262N.....	C-46
YAV702M10.....	C-135	YAV8CRS3.....	B-26	YAZ262TC14.....	C-46
YAV702M12.....	C-135	YAV952M10.....	C-136	YAZ262TC14E1.....	C-46
YAV702M14.....	C-135	YAV952M12.....	C-136	YAZ262TC14E2.....	C-46
YAV702M16.....	C-135	YAV952M14.....	C-136	YAZ262TC38.....	C-46
YAV702M6.....	C-135	YAV952M16.....	C-136	YAZ262TC38E16.....	C-46
YAV702M8.....	C-135	YAV952M20.....	C-136	YAZ264TC38E1G1.....	C-58, C-92
YAV70F2M10.....	C-148	YAV952M8.....	C-136	YAZ264TCG1.....	C-58, C-92
YAV70F2M12.....	C-148	YAV95F2M10.....	C-148	YAZ26TC12.....	C-37
YAV70F2M14.....	C-148	YAV95F2M12.....	C-148	YAZ26TC14.....	C-37
YAV70F2M16.....	C-148	YAV95F2M14.....	C-148	YAZ26TC38.....	C-37
YAV70F2M6.....	C-148	YAV95F2M16.....	C-148	YAZ272N.....	C-46
YAV70F2M8.....	C-148	YAV95F2M20.....	C-148	YAZ272TC14E2.....	C-46
YAV70FM10.....	C-145	YAV95F2M8.....	C-148	YAZ272TC38.....	C-46
YAV70FM12.....	C-145	YAV95FM10.....	C-145	YAZ27TC12.....	C-38
YAV70FM14.....	C-145	YAV95FM12.....	C-145	YAZ27TC38.....	C-38
YAV70FM16.....	C-145	YAV95FM14.....	C-145	YAZ282N.....	C-46
YAV70FM6.....	C-145	YAV95FM16.....	C-145	YAZ282NTC38.....	C-46
YAV70FM8.....	C-145	YAV95FM20.....	C-145	YAZ282TC14E2.....	C-46
YAV70M10.....	C-132	YAV95FM8.....	C-145	YAZ282TC38.....	C-46
YAV70M12.....	C-132	YAV95M10.....	C-132	YAZ284TCG1.....	C-58, C-92

ALPHA-NUMERIC INDEX BY CATALOG NUMBER

YAZ28TC12.....	C-38	YAZ34NT38FX.....	C-99	YAZ453TC12.....	C-39
YAZ28TC38.....	C-38	YAZ34TC12.....	C-38	YAZ45TC12.....	C-39
YAZ292N.....	C-46	YAZ34TC12FX.....	C-99	YAZ462N.....	C-47
YAZ292TC38.....	C-46	YAZ34TC38.....	C-38	YAZ46TC12.....	C-39
YAZ294TCG1.....	C-58, C-92	YAZ34TC38FX.....	C-99	YAZ472N.....	C-47
YAZ29TC12.....	C-38	YAZ352N.....	C-47	YAZ47TC12.....	C-39
YAZ29TC38.....	C-38	YAZ35TC12.....	C-38	YAZ482N.....	C-47
YAZ2C2N.....	C-46	YAZ362N.....	C-47	YAZ48TC12.....	C-39
YAZ2C2NTC38.....	C-46	YAZ362TC38.....	C-47	YAZ4C2N.....	C-45
YAZ2C2TC10E2.....	C-46	YAZ362TC38FX.....	C-105	YAZ4C2TC10E2.....	C-45
YAZ2C2TC14.....	C-46	YAZ36TC12.....	C-38	YAZ4C2TC14.....	C-45
YAZ2C2TC14E1.....	C-46	YAZ36TC38.....	C-38	YAZ4C2TC14E2.....	C-45
YAZ2C2TC14E2.....	C-46	YAZ36TC38FX.....	C-99	YAZ4C2TC38.....	C-45
YAZ2C2TC38.....	C-46	YAZ372N.....	C-47	YAZ4CTC12.....	C-37
YAZ2C2TC38E2.....	C-46	YAZ37TC12.....	C-38	YAZ4CTC14.....	C-37
YAZ2C2TC38E6.....	C-46	YAZ382ENT38FX.....	C-110	YAZ4CTC38.....	C-37
YAZ2C2TC38SL.....	C-55	YAZ382N.....	C-47	YAZ5C2N.....	C-45
YAZ2C2TC38SLBOX500.....	C-55	YAZ382NNTFX.....	C-105, C-110	YAZ5CTC12.....	C-37
YAZ2C2TC516E2.....	C-46	YAZ382NT38FX.....	C-105, C-110	YAZ6C2N.....	C-45
YAZ2C2TC516E7.....	C-46	YAZ382NTCFX.....	C-105	YAZ6C2TC10E2.....	C-45
YAZ2CTC12.....	C-37	YAZ382TC38FX.....	C-105	YAZ6C2TC14.....	C-45
YAZ2CTC14.....	C-37	YAZ38NT12FX.....	C-99	YAZ6C2TC14E1.....	C-45
YAZ2CTC38.....	C-37	YAZ38NT38FX.....	C-99	YAZ6C2TC14E2.....	C-45
YAZ2CTC516.....	C-37	YAZ38TC12.....	C-38	YAZ6C2TC38.....	C-45
YAZ302N.....	C-46	YAZ38TC12FX.....	C-99	YAZ6C2TC38E16.....	C-45
YAZ302TC38.....	C-46	YAZ38TC38FX.....	C-99	YAZ6C2TC38E2.....	C-45
YAZ302TC38FX.....	C-105	YAZ392N.....	C-47	YAZ6C2TC38E6.....	C-45
YAZ30TC12.....	C-38	YAZ392NNT.....	C-47	YAZ6CTC10.....	C-37
YAZ30TC38.....	C-38	YAZ392NT38.....	C-47	YAZ6CTC12.....	C-37
YAZ30TC38FX.....	C-98	YAZ392TC38.....	C-47	YAZ6CTC14.....	C-37
YAZ312N.....	C-47	YAZ39NT12.....	C-38	YAZ6CTC38.....	C-37
YAZ312NTCFX.....	C-105	YAZ39TC12.....	C-38	YAZ8C2TC10.....	C-45
YAZ312TC14E2.....	C-47	YAZ39TC38.....	C-38	YAZ8C2TC1090SL.....	C-55
YAZ312TC14E2FX.....	C-105	YAZ3C2N.....	C-45	YAZ8C2TC10E2.....	C-45
YAZ312TC38.....	C-47	YAZ3C2TC14.....	C-45	YAZ8C2TC10E2FX.....	C-104
YAZ312TC38FX.....	C-105	YAZ3C2TC14E2.....	C-45	YAZ8C2TC10FX.....	C-104
YAZ314TCG1.....	C-58, C-92	YAZ3C2TC38.....	C-45	YAZ8C2TC10SL.....	C-55
YAZ31TC12.....	C-38	YAZ3C2TC38E2.....	C-45	YAZ8C2TC14.....	C-45
YAZ31TC38.....	C-38	YAZ3C2TC38SL.....	C-55	YAZ8C2TC14E1.....	C-45
YAZ31TC38FX.....	C-98	YAZ3C2TC38SLBOX500.....	C-55	YAZ8C2TC14E1FX.....	C-104
YAZ322N.....	C-47	YAZ3CTC12.....	C-37	YAZ8C2TC14E2.....	C-45
YAZ322TC38.....	C-47	YAZ3CTC14.....	C-37	YAZ8C2TC14E2FX.....	C-104
YAZ322TC38FX.....	C-105	YAZ3CTC38.....	C-37	YAZ8C2TC14FX.....	C-104
YAZ32TC12.....	C-38	YAZ402N.....	C-47	YAZ8C2TC38.....	C-45
YAZ32TC38.....	C-38	YAZ402NTCFX.....	C-105	YAZ8C2TC38FX.....	C-104
YAZ32TC38FX.....	C-99	YAZ40TC12.....	C-39	YAZ8CTC10.....	C-37, C-98
YAZ332N.....	C-47	YAZ412N.....	C-47	YAZ8CTC14.....	C-37, C-98
YAZ33TC12.....	C-38	YAZ41TC12.....	C-39	YAZ8CTC38.....	C-37, C-98
YAZ342N.....	C-47	YAZ442N.....	C-47	YAZV102TC14.....	C-45
YAZ342NT38FX.....	C-105, C-110	YAZ442NT38FX.....	C-105, C-110	YAZV102TC14E1.....	C-104
YAZ342NTCFX.....	C-105	YAZ442TC38.....	C-47	YAZV102TC14E2.....	C-45
YAZ342TC14E2.....	C-47	YAZ44TC12.....	C-39	YAZV102TC14SL.....	C-112
YAZ342TC14E2FX.....	C-105	YAZ44TC38.....	C-39	YAZV10TC14.....	C-37
YAZ342TC38.....	C-47	YAZ452N.....	C-47	YAZV1C2TC14E1FX.....	C-104
YAZ342TC38FX.....	C-105	YAZ4532N.....	C-47	YAZV1C2TC14E2FX.....	C-104

ALPHA-NUMERIC INDEX BY CATALOG NUMBER

YAZV1C2TC14FX.....	C-104	YAZV2C2TC38FXSLBOX500.....	C-112	YC25L12.....	C-216
YAZV1C2TC38FX.....	C-104	YAZV2CTC12FX.....	C-98	YC26A25.....	H-23
YAZV1C2TC516E6FX.....	C-104	YAZV2CTC14FX.....	C-98	YC26A26.....	H-23
YAZV1C2TC516FX.....	C-104	YAZV2CTC38FX.....	C-98	YC26C2.....	H-22
YAZV1CTC14FX.....	C-98	YAZV4C2NT14E2FX.....	C-110	YC26C26.....	H-22
YAZV1CTC38FX.....	C-98	YAZV4C2TC14E2FX.....	C-104	YC26L12.....	C-216
YAZV1CTC516FX.....	C-98	YAZV4C2TC14FX.....	C-104	YC27L12.....	C-216
YAZV252NT14FX.....	C-110	YAZV4C2TC14FXSL.....	C-112	YC28A2.....	H-23
YAZV252NTCFX.....	C-104	YAZV4C2TC14FXSLBOX500.....	C-112	YC28A25.....	H-23
YAZV252TC14E2FX.....	C-104	YAZV4C2TC38E2-FX.....	C-104	YC28A26.....	H-23
YAZV252TC14FX.....	C-104	YAZV4C2TC38FX.....	C-104	YC28A28.....	H-23
YAZV252TC14FXSL.....	C-112	YAZV4C2TC38FXSL.....	C-112	YC28C2.....	H-22
YAZV252TC14FXSLBOX500.....	C-112	YAZV4C2TC38FXSLBOX500.....	C-112	YC28C26.....	H-22
YAZV252TC38FX.....	C-104	YAZV4CTC14FX.....	C-98	YC28C28.....	H-22
YAZV252TC38FXSL.....	C-112	YAZV4CTC38FX.....	C-98	YC28U26.....	H-26
YAZV252TC38FXSLBOX500.....	C-112	YAZV6C2TC10E2FX.....	C-104	YC2A2.....	H-23
YAZV25TC12FX.....	C-98	YAZV6C2TC10FX90SL.....	C-112	YC2A4.....	H-23
YAZV25TC14FX.....	C-98	YAZV6C2TC14E1FX.....	C-104	YC2C2.....	H-22
YAZV25TC38FX.....	C-98	YAZV6C2TC14E2FX.....	C-104	YC2C4.....	H-22
YAZV262NTCFX.....	C-105	YAZV6C2TC14FX.....	C-104	YC2L12.....	C-216
YAZV262TC14E2FX.....	C-105	YAZV6C2TC14FXSL.....	C-112	YC33R26.....	H-23
YAZV262TC14FX.....	C-105	YAZV6C2TC14FXSLBOX500.....	C-112	YC33R26U.....	H-26
YAZV262TC14FXSL.....	C-112	YAZV6C2TC38E2FX.....	C-104	YC3L12.....	C-216
YAZV262TC14FXSLBOX500.....	C-112	YAZV6C2TC38E6FX.....	C-104	YC4A4.....	H-23
YAZV262TC38E6FX.....	C-105	YAZV6C2TC38FX.....	C-104	YC4A6.....	H-23
YAZV262TC38FX.....	C-105	YAZV6C2TC38FXSL.....	C-112	YC4C4.....	H-22
YAZV262TC38FXSL.....	C-112	YAZV6C2TC38FXSLBOX500.....	C-112	YC4C6.....	H-22
YAZV262TC38FXSLBOX500.....	C-112	YAZV6CTC14FX.....	C-98	YC4C8.....	H-22
YAZV26TC12FX.....	C-98	YAZV6CTC38FX.....	C-98	YC4L12.....	C-216
YAZV26TC14FX.....	C-98	YBM1CL.....	B-28	YC4U1.....	H-26
YAZV26TC38FX.....	C-98	YBM1CL3.....	B-28	YC6L12.....	C-216
YAZV272TC14E2FX.....	C-105	YBM25L.....	B-28	YC8C8.....	H-22
YAZV272TC38FX.....	C-105	YBM25L1.....	B-28	YC8L12.....	C-216
YAZV27TC38FX.....	C-98	YBM25L2.....	B-28	YCA252N.....	H-77
YAZV282NT38FX.....	C-110	YBM26L.....	B-28	YCA25R2N.....	H-79
YAZV282NTCFX.....	C-105	YBM2CL.....	B-28	YCA25RL2N.....	H-78
YAZV282TC14E2FX.....	C-105	YBM2CL1.....	B-28	YCA262N.....	H-77
YAZV282TC14FXSL.....	C-112	YBM2CL2.....	B-28	YCA26R2N.....	H-79
YAZV282TC14FXSLBOX500.....	C-112	YBM4CL.....	B-28	YCA26RL2N.....	H-78
YAZV282TC38FX.....	C-105	YBM4CL1.....	B-28	YCA272N.....	H-77
YAZV282TC38FXSL.....	C-112	YBM4CL2.....	B-28	YCA27R2N.....	H-79
YAZV282TC38FXSLBOX500.....	C-112	YBM4CL4.....	B-28	YCA27RL2N.....	H-78
YAZV28NT38FX.....	C-98	YBM6CL.....	B-28	YCA282N.....	H-77
YAZV28TC12FX.....	C-98	YBM6CL2.....	B-28	YCA28R2N.....	H-79
YAZV28TC38FX.....	C-98	YBM6CL3.....	B-28	YCA28RL2N.....	H-78
YAZV292NT516FX.....	C-105, C-110	YBM6CL9.....	B-28	YCA292N.....	H-77
YAZV29NT516FX.....	C-98	YBM8C.....	B-28	YCA2R2N.....	H-79
YAZV2C2NT14E2FX.....	C-110	YBM8CT2.....	B-28	YCA2RL2N.....	H-78
YAZV2C2NTCFX.....	C-104	YBM8CT4.....	B-28	YCA302N.....	H-77
YAZV2C2TC14E2FX.....	C-104	YC10C10.....	H-22	YCA30R2N.....	H-79
YAZV2C2TC14FX.....	C-104	YC1L12.....	C-216	YCA312N.....	H-77
YAZV2C2TC14FXSL.....	C-112	YC1U1.....	H-26	YCA321R2N.....	H-79
YAZV2C2TC14FXSLBOX500.....	C-112	YC25A2.....	H-23	YCA321RL2N.....	H-78
YAZV2C2TC38FX.....	C-104	YC25A25.....	H-23	YCA322N.....	H-77
YAZV2C2TC38FXSL.....	C-112	YC25A4.....	H-23	YCA33R2N.....	H-79

ALPHA-NUMERIC INDEX BY CATALOG NUMBER

YCA342N.....	H-77	YCB4U1.....	H-39	YCR28RG6.....	H-54
YCA35R2N.....	H-79	YCHC29TC2.....	C-218	YCR28RG7.....	H-54
YCA361R2N.....	H-79	YCHC29TC29.....	C-218	YCR28RG8.....	H-54
YCA37R2N.....	H-79	YCHC2TC2.....	C-218	YCR291RG2.....	H-54
YCA391A2N.....	H-80	YCHC34TC2.....	C-218	YCR291RG3.....	H-54
YCA392N.....	H-77	YCHC34TC29.....	C-218	YCR291RG4.....	H-54
YCA39R2N.....	H-79	YCHC34TC34.....	C-218	YCR291RG5.....	H-54
YCA43R2N.....	H-80	YCHC39TC2.....	C-218	YCR30RG4.....	H-54
YCA441A4N.....	H-80	YCHC39TC31.....	C-218	YCR30RG6.....	H-54
YCA44A2NG2.....	H-80	YCHC39TC39.....	C-218	YCR30RG7.....	H-54
YCA451A4N.....	H-80	YCHC44TC44.....	C-218	YCR32RG1.....	H-54
YCA45R2N.....	H-80	YCHC8TC8.....	C-218	YCR32RG2.....	H-54
YCA48R4N.....	H-80	YCP25L13CTN.....	C-231	YCR32RG3.....	H-54
YCA4R2N.....	H-79	YCP25L20CTN.....	C-231	YCR32RG4.....	H-54
YCA4RL2N.....	H-78	YCP25L27CTN.....	C-231	YCR32RG5.....	H-54
YCAC284N.....	H-77	YCP25L34CTN.....	C-231	YCR32RG6.....	H-54
YCAC324N.....	H-77	YCP25L41CTN.....	C-231	YCR32RG7.....	H-54
YCAC344N.....	H-77	YCP28L13CTN.....	C-231	YCS25.....	H-50
YCAC394N.....	H-77	YCP28L20CTN.....	C-231	YCS25R.....	H-49, H-51
YCAC444N.....	H-77	YCP28L27CTN.....	C-231	YCS25RL.....	H-52
YCAK25R4N.....	H-79	YCP28L34CTN.....	C-231	YCS26.....	H-50
YCAK28A2G1.....	H-82	YCP28L41CTN.....	C-231	YCS26A.....	H-53
YCAK28R4N.....	H-79	YCP31L13CTN.....	C-231	YCS26R.....	H-51
YCAK29A2G1.....	H-82	YCP31L20CTN.....	C-231	YCS26RL.....	H-52
YCAK30R4N.....	H-79	YCP31L27CTN.....	C-231	YCS27.....	H-50
YCAK31A2G1.....	H-82	YCP31L34CTN.....	C-231	YCS27R.....	H-51
YCAK31AG1.....	H-82	YCP31L41CTN.....	C-231	YCS28.....	H-50
YCAK321R4N.....	H-79	YCP34L13CTN.....	C-232	YCS28A.....	H-53
YCAK33R4N.....	H-79	YCP34L20CTN.....	C-232	YCS28R.....	H-51
YCAK34A2G3.....	H-82	YCP34L27CTN.....	C-232	YCS28RL.....	H-52
YCAK35R4N.....	H-79	YCP34L34CTN.....	C-232	YCS29.....	H-50
YCAK361A4N.....	H-79	YCP34L41CTN.....	C-232	YCS2R.....	H-51
YCAK361R4N.....	H-79	YCP39L13CTN.....	C-232	YCS30.....	H-50
YCAK36A2G1.....	H-82	YCP39L20CTN.....	C-232	YCS301A.....	H-53
YCAK37R4N.....	H-79	YCP39L27CTN.....	C-232	YCS30R.....	H-51
YCAK391A4N.....	H-80	YCP39L34CTN.....	C-232	YCS31.....	H-50
YCAK39A2G2.....	H-82	YCP39L41CTN.....	C-232	YCS31A.....	H-53
YCAK39R4N.....	H-79	YCP44L13CTN.....	C-232	YCS32.....	H-50
YCAK43R4N.....	H-80	YCP44L20CTN.....	C-232	YCS321R.....	H-51
YCAK44A2G2.....	H-82	YCP44L27CTN.....	C-232	YCS321RL.....	H-52
YCAK453R4N.....	H-80	YCP44L34CTN.....	C-232	YCS331A.....	H-53
YCAK45R4N.....	H-80	YCP44L41CTN.....	C-232	YCS33R.....	H-51
YCB1U1.....	H-39	YCP4CL13CTN.....	C-231	YCS34.....	H-50
YCB25R.....	H-38	YCP4CL20CTN.....	C-231	YCS341RL.....	H-52
YCB26R.....	H-38	YCP4CL27CTN.....	C-231	YCS351A.....	H-53
YCB27R.....	H-38	YCP4CL34CTN.....	C-231	YCS35R.....	H-51
YCB28R.....	H-38	YCR25RG6.....	H-54	YCS361A.....	H-53
YCB28U26.....	H-39	YCR2625.....	H-53	YCS361R.....	H-51
YCB2R.....	H-38	YCR26RG2.....	H-54	YCS37R.....	H-51
YCB321R.....	H-38	YCR26RG3.....	H-54	YCS39.....	H-50
YCB33R.....	H-38	YCR2725.....	H-53	YCS391A.....	H-53
YCB33R26U.....	H-39	YCR27RG5.....	H-54	YCS39R.....	H-51
YCB35R.....	H-38	YCR27RG6.....	H-54	YCS43R.....	H-51
YCB361R.....	H-38	YCR2825.....	H-53	YCS44.....	H-50
YCB38R26U.....	H-39	YCR28RG5.....	H-54	YCS453R.....	H-51

ALPHA-NUMERIC INDEX BY CATALOG NUMBER

YCS45R.....	H-51	YDS25RP2.....	H-64	YDS30RP2.....	H-64
YCS4R.....	H-51	YDS26.....	H-57	YDS31.....	H-57
YCT2626.....	H-32	YDS261R.....	H-65	YDS311AT.....	H-58, H-62
YCT2828.....	H-32	YDS261RP1.....	H-65	YDS312E.....	H-66
YCU25A.....	H-50	YDS26AT.....	H-58	YDS312H.....	H-66
YCU25R.....	H-55	YDS26F.....	H-70	YDS31AT.....	H-58
YCU26R.....	H-55	YDS26R.....	H-64	YDS32.....	H-57
YCU27R.....	H-55	YDS26RL.....	H-59	YDS321R.....	H-64
YCU28A.....	H-50	YDS26RLNI.....	H-61	YDS321RL.....	H-59
YCU28R.....	H-55	YDS26RLY.....	H-63	YDS321RLNI.....	H-61
YCU291A.....	H-50	YDS26RP1.....	H-64, H-66	YDS321RLY.....	H-63
YCU2CA.....	H-50	YDS26RP2.....	H-64	YDS321RP1.....	H-64
YCU2R.....	H-55	YDS27.....	H-57	YDS326R.....	H-64
YCU301A.....	H-50	YDS271R.....	H-65	YDS32LT.....	H-60
YCU30R.....	H-55	YDS271RP1.....	H-65	YDS32R.....	H-64
YCU321R.....	H-55	YDS27AT.....	H-58, H-62	YDS32RP2.....	H-64
YCU4R.....	H-55	YDS27R.....	H-64	YDS331AT.....	H-58, H-62
YCU4RG1.....	H-55	YDS27RE.....	H-66	YDS33R.....	H-64
YCUT129ACSR.....	N-84	YDS27RL.....	H-59	YDS33RP1.....	H-64
YD28REP2.....	H-66	YDS27RLNI.....	H-61	YDS34.....	H-57
YDR25R2RL.....	H-68	YDS27RLY.....	H-63	YDS341RL.....	H-60
YDR25R4RL.....	H-68	YDS27RP1.....	H-64, H-66	YDS341RLNI.....	H-61
YDR27R25RL.....	H-68	YDS27RP2.....	H-64-66	YDS34R.....	H-64
YDR28R26R.....	H-68	YDS28.....	H-57	YDS34RP2.....	H-64, H-65
YDR28R27R.....	H-68	YDS28AT.....	H-58, H-62	YDS351AT.....	H-58
YDR2R4RG1.....	H-68	YDS28F.....	H-70	YDS35R.....	H-64
YDR391RL321RL.....	H-68	YDS28R.....	H-64	YDS35RP1.....	H-64
YDS011R.....	H-65	YDS28RE.....	H-66	YDS361AT.....	H-58
YDS011RP1.....	H-65	YDS28RL.....	H-59	YDS361R.....	H-64, H-66
YDS021R.....	H-64	YDS28RLNI.....	H-61	YDS361RL.....	H-60, H-67
YDS021RE.....	H-66	YDS28RLY.....	H-63	YDS361RLNI.....	H-61
YDS021REP1.....	H-66	YDS28RP1.....	H-64, H-66	YDS361RP1.....	H-64, H-66
YDS021RL.....	H-59	YDS28RP2.....	H-64	YDS36LT.....	H-60
YDS021RLNI.....	H-61	YDS29.....	H-57	YDS36R.....	H-64
YDS021RLY.....	H-63	YDS291AT.....	H-58	YDS36RP2.....	H-64, H-65
YDS021RP1.....	H-64	YDS291R.....	H-64	YDS375H.....	H-66
YDS1C.....	H-50, H-57	YDS291RP1.....	H-64	YDS37RP1.....	H-64
YDS1C3.....	H-57	YDS29AT.....	H-58	YDS39.....	H-57
YDS1R.....	H-64	YDS2C.....	H-50, H-57	YDS391AT.....	H-58
YDS1RP1.....	H-64	YDS2C3.....	H-57	YDS392R.....	H-65
YDS1RP2.....	H-64	YDS2CA.....	H-58, H-62	YDS39RP1.....	H-65
YDS1W.....	H-56	YDS2F.....	H-70	YDS3C3.....	H-57
YDS25.....	H-57	YDS2KT.....	H-70	YDS3K10.....	H-69
YDS250E.....	H-66	YDS2RE.....	H-66	YDS3K5.....	H-69
YDS251R.....	H-65	YDS2REP2.....	H-66	YDS3K6.....	H-69-70
YDS251RP1.....	H-65	YDS2RL.....	H-59	YDS3K7.....	H-69
	H-49, H-58,	YDS2RLNI.....	H-61	YDS3K8.....	H-69
YDS25AT.....	H-62	YDS2RLY.....	H-63	YDS3W.....	H-56
YDS25F.....	H-70	YDS2W.....	H-50, H-56	YDS40R.....	H-65
YDS25R.....	H-64	YDS2WA.....	H-58	YDS41RP2.....	H-64-65
YDS25REP2.....	H-66	YDS30.....	H-57	YDS42R.....	H-65
YDS25RL.....	H-59	YDS301AT.....	H-58	YDS431AT.....	H-58
YDS25RLNI.....	H-61	YDS30LT.....	H-60	YDS43R43RS.....	H-65
YDS25RLY.....	H-63	YDS30R.....	H-64	YDS43R45RS.....	H-65
YDS25RP1.....	H-64, H-66	YDS30RP1.....	H-64	YDS43RP1.....	H-65

ALPHA-NUMERIC INDEX BY CATALOG NUMBER

YDS43RP2.....	H-65	YE26LH89.....	H-43	YF0415IDL.....	B-76
YDS44.....	H-57	YE26R60.....	H-43	YF0415IWL.....	B-76
YDS44RP2.....	H-64-65	YE27R60.....	H-43	YF0415UIL.....	B-73
YDS451R34RS.....	H-65	YE28LH128.....	H-43	YF0416IDL.....	B-76
YDS451R49RS.....	H-65	YE28R60.....	H-43	YF0416ITL.....	B-76
YDS451RP1.....	H-65	YE2CLH128.....	H-43	YF0416IWL.....	B-76
YDS45R45RS.....	H-65	YE2CLH129.....	H-43	YF0418IDL.....	B-76
YDS45RP1.....	H-65	YE2R25.....	H-43	YF0418UIL.....	B-73
YDS45RP2.....	H-65	YE2WAG5.....	H-43	YF0420UIL.....	B-73
YDS49R.....	H-65	YE30R60.....	H-43	YF0422IDL.....	B-76
YDS49RP1.....	H-65	YE31LH96.....	H-43	YF0425IDL.....	B-76
YDS49RP2.....	H-65	YE31P4/0X110FX.....	C-227	YF0425UIL.....	B-73
YDS4C.....	H-50, H-57	YE32P250X125FX.....	C-227	YF0432UIL.....	B-73
YDS4CA.....	H-49, H-58	YE32R60.....	H-43	YF0612IDL.....	B-75
YDS4KT.....	H-70	YE34LH119.....	H-43	YF0612ITL.....	B-75
YDS4RL.....	H-59	YE34LH120.....	H-43	YF0612IWL.....	B-75
YDS4RLNI.....	H-61	YE34P250X125FX.....	C-227	YF0612UIL.....	B-72
YDS4RLY.....	H-63	YE361R60.....	H-43	YF0615UIL.....	B-72
YDS4W.....	H-50, H-56	YE36P350X150FX.....	C-227	YF0618IDL.....	B-75
YDS4WA.....	H-49, H-58	YE38P350X150FX.....	C-227	YF0618ITL.....	B-75
YDS500H.....	H-66	YE39P500X150FX.....	C-227	YF0618IWL.....	B-75
YDS50R.....	H-65	YE39R60.....	H-43	YF0618UIL.....	B-72
YDS6C.....	H-50, H-57	YE44P600X170FX.....	C-227	YF0625UIL.....	B-72
YDS6CA.....	H-58	YE4R25.....	H-43	YF0812IDL.....	B-75
YDS6KT.....	H-70	YE6R25.....	H-43	YF0812ITL.....	B-75
YDS6W.....	H-50, H-56	YEV1CP3X84FX.....	C-227	YF0812IWL.....	B-75
YDS6WA.....	H-58	YEV25P2X84FX.....	C-227	YF0812UIL.....	B-72
YDS6WK.....	H-69	YEV26P1X84FX.....	C-227	YF0815IDL.....	B-75
YDS75.....	H-56	YEV27P1/0X84FX.....	C-227	YF0815UIL.....	B-72
YDS76.....	H-56	YEV28P2/0X100FX.....	C-227	YF0818IDL.....	B-75
YDS78.....	H-56	YEV29P3/0X109FX.....	C-227	YF0818ITL.....	B-75
YDS7K5.....	H-69	YEV2CP4X75FX.....	C-227	YF0818IWL.....	B-75
YDS7K6.....	H-69	YEV4CP6X75FX.....	C-227	YF0818UIL.....	B-72
YDS7K7.....	H-69	YF0112IDL.....	B-76	YF1/012IDL.....	B-76
YDS7M10T.....	H-70, I-16	YF0116IDL.....	B-76	YF1/016IDL.....	B-76
YDS7M6T.....	H-70, I-16	YF0118UIL.....	B-73	YF1/018UIL.....	B-73
YDS7M7T.....	H-70, I-16	YF0120IDL.....	B-76	YF1/020IDL.....	B-76
YDS7M8T.....	H-70, I-16	YF0122IDL.....	B-76	YF1/022IDL.....	B-76
YDS7M9T.....	H-70, I-16	YF0122UIL.....	B-73	YF1/022UIL.....	B-73
YDS8KT.....	H-70	YF0125IDL.....	B-76	YF1/025IDL.....	B-76
YDS8W.....	H-50, H-56	YF0125UIL.....	B-73	YF1/025UIL.....	B-73
YDS8WG1.....	H-56	YF0132UIL.....	B-73	YF1/032UIL.....	B-73
YDS8WK.....	H-69	YF0215UIL.....	B-73	YF1010IDL.....	B-75
YDSR25RL.....	H-67	YF0216IDL.....	B-76	YF1010ITL.....	B-75
YDSR26RL.....	H-67	YF0218IDL.....	B-76	YF1010IWL.....	B-75
YDSR27RL.....	H-67	YF0218ITL.....	B-76	YF1010UIL.....	B-72
YDSR28RL.....	H-67	YF0218IWL.....	B-76	YF1012IDL.....	B-75
YDSR2RL.....	H-67	YF0220UIL.....	B-73	YF1012ITL.....	B-75
YDSR321RL.....	H-67	YF0222IDL.....	B-76	YF1012IWL.....	B-75
YDSR341RL.....	H-67	YF0225IDL.....	B-76	YF1012UIL.....	B-72
YDSR4RL.....	H-67	YF0225UIL.....	B-73	YF1015UIL.....	B-72
YE1WAG1.....	H-43	YF0232UIL.....	B-73	YF1018IDL.....	B-75
YE25LH97.....	H-43	YF0412IDL.....	B-76	YF1018ITL.....	B-75
YE25R25.....	H-43	YF0412IWL.....	B-76	YF1018IWL.....	B-75
YE26LH88.....	H-43	YF0412UIL.....	B-73	YF1018UIL.....	B-72

ALPHA-NUMERIC INDEX BY CATALOG NUMBER

YF1022FL.....	N-41	YF1806ITL.....	B-74	YF2406ITL.....	B-74
YF1209IDL.....	B-75	YF1806IWL.....	B-74	YF2406IWL.....	B-74
YF1209ITL.....	B-75	YF1806UIL.....	B-72	YF2408ITL.....	B-74
YF1209IWL.....	B-75	YF1808IDL.....	B-74	YF2408IWL.....	B-74
YF1209UIL.....	B-72	YF1808ITL.....	B-74	YF25032UIL.....	B-73
YF1210IDL.....	B-75	YF1808IWL.....	B-74	YF25040UIL.....	B-73
YF1210ITL.....	B-75	YF1808UIL.....	B-72	YF261CSKIT.....	N-42
YF1210IWL.....	B-75	YF1810IDL.....	B-74	YF268CFSL.....	N-41
YF1212IDL.....	B-75	YF1810ITL.....	B-74	YF3/025UIL.....	B-73
YF1212ITL.....	B-75	YF1810IWL.....	B-74	YF3/030UIL.....	B-73
YF1212IWL.....	B-75	YF1810UIL.....	B-72	YF3/032UIL.....	B-73
YF1212UIL.....	B-72	YF1812IDL.....	B-74	YF35032UIL.....	B-73
YF1215UIL.....	B-72	YF1812ITL.....	B-74	YF35040UIL.....	B-73
YF1218IDL.....	B-75	YF1812IWL.....	B-74	YF4/032UIL.....	B-73
YF1218ITL.....	B-75	YF1812UIL.....	B-72	YF4/034UIL.....	B-73
YF1218IWL.....	B-75	YF1818IDL.....	B-74	YF4/040UIL.....	B-73
YF1218UIL.....	B-72	YF1818ITL.....	B-74	YFA28CP2.....	K-31
YF1408IDL.....	B-75	YF1818IWL.....	B-74	YFA28CPL2.....	K-32
YF1408ITL.....	B-75	YF2/020IDL.....	B-76	YFA28CR2.....	K-31
YF1408IWL.....	B-75	YF2/022UIL.....	B-73	YFA29CP2.....	K-31
YF1408UIL.....	B-72	YF2/025IDL.....	B-76	YFA29CPL2.....	K-32
YF1410IDL.....	B-75	YF2/025UIL.....	B-73	YFA29CR2.....	K-31
YF1410ITL.....	B-75	YF2/032IDL.....	B-76	YFA30CP2.....	K-31
YF1410IWL.....	B-75	YF2/032UIL.....	B-73	YFA30CPL2.....	K-32
YF1410UIL.....	B-72	YF2006IDL.....	B-74	YFA30CR2.....	K-31
YF1412IDL.....	B-75	YF2006ITL.....	B-74	YFA31CP2.....	K-31
YF1412ITL.....	B-75	YF2006IWL.....	B-74	YFA31CPL2.....	K-32
YF1412IWL.....	B-75	YF2006UIL.....	B-72	YFA31CR2.....	K-31
YF1412UIL.....	B-72	YF2008IDL.....	B-74	YFA32CPL2.....	K-32
YF1418IDL.....	B-75	YF2008ITL.....	B-74	YFA32CR2.....	K-31
YF1418ITL.....	B-75	YF2008IWL.....	B-74	YFA34CP2.....	K-31
YF1418IWL.....	B-75	YF2010IDL.....	B-74	YFA34CPL2.....	K-32
YF1418UIL.....	B-72	YF2010ITL.....	B-74	YFA34CR2.....	K-31
YF1606IDL.....	B-75	YF2010IWL.....	B-74	YFA39CP2.....	K-31
YF1606ITL.....	B-75	YF2010UIL.....	B-72	YFA39CPL2.....	K-32
YF1606IWL.....	B-75	YF2012IDL.....	B-74	YFA39CR2.....	K-31
YF1607UIL.....	B-72	YF2012ITL.....	B-74	YFAP282.....	K-33
YF1608IDL.....	B-75	YF2012IWL.....	B-74	YFAP28L2.....	K-34
YF1608ITL.....	B-75	YF2012UIL.....	B-72	YFAP292.....	K-33
YF1608IWL.....	B-75	YF2018IDL.....	B-74	YFAP29L2.....	K-34
YF1608UIL.....	B-72	YF2018ITL.....	B-74	YFAP302.....	K-33
YF1610IDL.....	B-75	YF2018IWL.....	B-74	YFAP30L2.....	K-34
YF1610ITL.....	B-75	YF2205IDL.....	B-74	YFAP312.....	K-33
YF1610IWL.....	B-75	YF2206IDL.....	B-74	YFAP31L2.....	K-34
YF1610UIL.....	B-72	YF2206ITL.....	B-74	YFAP322.....	K-33
YF1612IDL.....	B-75	YF2206IWL.....	B-74	YFAP32L2.....	K-34
YF1612ITL.....	B-75	YF2208IDL.....	B-74	YFAP342.....	K-33
YF1612IWL.....	B-75	YF2208ITL.....	B-74	YFAP34L2.....	K-34
YF1612UIL.....	B-72	YF2208IWL.....	B-74	YFAP392.....	K-33
YF1615IDL.....	B-75	YF2210IDL.....	B-74	YFAP39L2.....	K-34
YF1618IDL.....	B-75	YF2210ITL.....	B-74	YFAR282.....	K-33
YF1618ITL.....	B-75	YF2210IWL.....	B-74	YFAR292.....	K-33
YF1618IWL.....	B-75	YF2212IDL.....	B-74	YFAR302.....	K-33
YF1618UIL.....	B-72	YF2212ITL.....	B-74	YFAR312.....	K-33
YF1806IDL.....	B-74	YF2212IWL.....	B-74	YFAR322.....	K-33

ALPHA-NUMERIC INDEX BY CATALOG NUMBER

YFAR342.....	K-33	YFS32CPL.....	K-28	YGC10C10.....	E-13
YFAR392.....	K-33	YFS32CR.....	K-27	YGC4C4.....	E-13
YFD365.....	C-225	YFS34CP.....	K-27	YGC6C6.....	E-13
YFM28CP.....	K-35	YFS34CPL.....	K-28	YGC6C8.....	E-13
YFM28CPL.....	K-36	YFS34CR.....	K-27	YGC8C8.....	E-13
YFM28CR.....	K-35	YFSP28.....	K-29	YGF29-2N.....	E-22
YFM29CP.....	K-35	YFSP28L.....	K-30	YGF29-4N.....	E-22
YFM29CPL.....	K-36	YFSP29.....	K-29	YGF34-2N.....	E-22
YFM29CR.....	K-35	YFSP29L.....	K-30	YGF34-4N.....	E-22
YFM30CP.....	K-35	YFSP30.....	K-29	YGHA25-2N.....	E-17
YFM30CPL.....	K-36	YFSP30L.....	K-30	YGHA26-2N.....	E-17
YFM30CR.....	K-35	YFSP31.....	K-29	YGHA27-2N.....	E-17
YFM31CP.....	K-35	YFSP31L.....	K-30	YGHA28-2N.....	E-17
YFM31CPL.....	K-36	YFSP32.....	K-29	YGHA29-2N.....	E-17
YFM31CR.....	K-35	YFSP32L.....	K-30	YGHA2C-2N.....	E-17
YFM32CP.....	K-35	YFSP34.....	K-29	YGHA31-2N.....	E-17
YFM32CPL.....	K-36	YFSP34L.....	K-30	YGHA34-2N.....	E-17
YFM32CR.....	K-35	YFSR28.....	K-29	YGHC26C2.....	E-10
YFM34CP.....	K-35	YFSR29.....	K-29	YGHC26C26.....	E-10
YFM34CPL.....	K-36	YFSR30.....	K-29	YGHC26C26CN.....	E-11
YFM34CR.....	K-35	YFSR31.....	K-29	YGHC29C26.....	E-10
YFMP28.....	K-37	YFSR32.....	K-29	YGHC29C29.....	E-10
YFMP28L.....	K-38	YFSR34.....	K-29	YGHC29C29CN.....	E-11
YFMP29.....	K-37	YFTW0614DL.....	B-77	YGHC2C2.....	E-10
YFMP29L.....	K-38	YFTW0814DL.....	B-77	YGHC2C2CN.....	E-11
YFMP30.....	K-37	YFTW1014DL.....	B-77	YGHC34C26.....	E-10
YFMP30L.....	K-38	YFTW1212DL.....	B-77	YGHC34C29.....	E-10
YFMP31.....	K-37	YFTW1410DL.....	B-77	YGHC34C34.....	E-10
YFMP31L.....	K-38	YFTW1413DL.....	B-77	YGHHC26C26.....	E-12
YFMP32.....	K-37	YFTW1608DL.....	B-77	YGHHC29C26.....	E-12
YFMP32L.....	K-38	YFTW1612DL.....	B-77	YGHHC29C29.....	E-12
YFMP34.....	K-37	YFTW1808DL.....	B-77	YGHHC34C26.....	E-12
YFMP34L.....	K-38	YFTW1810DL.....	B-77	YGHHC34C29.....	E-12
YFMR28.....	K-37	YFTW2008DL.....	B-77	YGHHC34C34.....	E-12
YFMR29.....	K-37	YFTW2010DL.....	B-77	YGHP29C2.....	E-8
YFMR30.....	K-37	YFTW2208DL.....	B-77	YGHP29C26.....	E-8
YFMR31.....	K-37	YG14B2TC2C2C.....	E-27	YGHP29C29.....	E-8
YFMR32.....	K-37	YG14B2TC2C6C.....	E-27	YGHP29C6W6W.....	E-8
YFMR34.....	K-37	YG14BTC28.....	E-27	YGHP2C2.....	E-8
YFN540.....	C-225	YGA25-2N.....	E-18	YGHP2C6W6W.....	E-8
YFO140.....	C-225	YGA26-2N.....	E-18	YGHP34C2.....	E-8
YFR865.....	C-225	YGA28-2N.....	E-18	YGHP34C26.....	E-8
YFS28CP.....	K-27	YGA29-2N.....	E-18	YGHP34C29.....	E-8
YFS28CPL.....	K-28	YGA2C-2N.....	E-18	YGHP34C34.....	E-8
YFS28CR.....	K-27	YGA2C-2TC38.....	E-18	YGHP58C2W-2.....	E-9
YFS29CP.....	K-27	YGA34-2N.....	E-18	YGHP58C2W-2TN.....	E-9
YFS29CPL.....	K-28	YGA6C-2N.....	E-18	YGHR26C100.....	E-15
YFS29CR.....	K-27	YGA6C-2TC38E2G1.....	E-18	YGHR26C12.....	E-15
YFS30CP.....	K-27	YGA6C-TC10.....	E-18	YGHR26C34.....	E-15
YFS30CPL.....	K-28	YGA6C-TC14.....	E-18	YGHR26C58.....	E-15
YFS30CR.....	K-27	YGA6C-TC516.....	E-18	YGHR29C100.....	E-15
YFS31CP.....	K-27	YGA8C-2N.....	E-18	YGHR29C12.....	E-15
YFS31CPL.....	K-28	YGA8C-TC10.....	E-18	YGHR29C34.....	E-15
YFS31CR.....	K-27	YGA8C-TC14.....	E-18	YGHR29C58.....	E-15
YFS32CP.....	K-27	YGA8C-TC516.....	E-18	YGHR34C100.....	E-15

ALPHA-NUMERIC INDEX BY CATALOG NUMBER

YGHR34C34.....	E-15	YGS34.....	E-21	YHD6.....	H-28, H-31
YGHR34C58.....	E-15	YGS6C.....	E-21	YHD7.....	H-28, H-31
YGHR58C2W-3.....	E-16	YGS8C.....	E-21	YHN450.....	H-30
YGHS25.....	E-20	YGT275.....	E-26	YHN500.....	H-30
YGHS26.....	E-20	YH2929.....	C-220-222	YHN500J1496.....	H-40
YGHS27.....	E-20	YH2929WC.....	C-220-222	YHN525.....	H-30
YGHS28.....	E-20	YH2929WCC.....	C-220-222	YHN550.....	H-30
YGHS29.....	E-20	YH292C.....	C-220-222	YHN600.....	H-30
YGHS2C.....	E-20	YH292CWC.....	C-220-222	YHO1.....	H-28, H-31
YGHS31.....	E-20	YH292CWCC.....	C-220-222	YHO100.....	H-28-29
YGHS34.....	E-20	YH298C.....	C-220-222	YHO100J1444.....	H-40
YGIBS28-338-2N.....	E-24	YH298CWC.....	C-220-222	YHO125.....	H-31
YGIBS28-400-2N.....	E-24	YH298CWCC.....	C-220-222	YHO150.....	H-28-29
YGIBS28-462-2N.....	E-24	YH2C2C.....	C-220-222	YHO150J1444.....	H-40
YGIBS28-550-2N.....	E-24	YH2C2CWC.....	C-220-222	YHO2.....	H-28, H-31
YGIBS28-613-2N.....	E-24	YH2C2CWCC.....	C-220-222	YHR700.....	H-30
YGIBS28-675-2N.....	E-24	YH3429.....	C-220-222	YHR750.....	H-30
YGIBS34-338-2N.....	E-24	YH3429WC.....	C-220-222	YHR800.....	H-30
YGIBS34-400-2N.....	E-24	YH3429WCC.....	C-220-222	YHR850.....	H-30
YGIBS34-462-2N.....	E-24	YH3434.....	C-220-222	YHR900.....	H-30
YGIBS34-550-2N.....	E-24	YH3434WC.....	C-220-222	YHR950.....	H-30
YGIBS34-675-2N.....	E-24	YH3434WCC.....	C-220-222	YHSA10K10.....	B-12
YGIW28-1000-2N.....	E-24	YH3931.....	C-220-222	YHSA10K10BF.....	B-43
YGIW28-338-2N.....	E-24	YH3931WC.....	C-220-222	YHSA10K10F.....	B-34
YGIW28-400-2N.....	E-24	YH3931WCC.....	C-220-222	YHSA10K10FRK.....	B-34
YGIW28-462-2N.....	E-24	YH3939.....	C-220-222	YHSA10K10LF.....	B-39
YGIW28-550-2N.....	E-24	YH3939WC.....	C-220-222	YHSA10K10RK.....	B-12
YGIW28-613-2N.....	E-24	YH3939WCC.....	C-220-222	YHSA10K12.....	B-12
YGIW28-675-2N.....	E-24	YH4429.....	C-220-222	YHSA10K12RK.....	B-12
YGIW28-750-2N.....	E-24	YH4429WC.....	C-220-222	YHSA10K14.....	B-12
YGIW34-338-2N.....	E-24	YH4429WCC.....	C-220-222	YHSA10K14FRK.....	B-34
YGIW34-400-2N.....	E-24	YH4434.....	C-220-222	YHSA10K14RK.....	B-12
YGIW34-462-2N.....	E-24	YH4434WC.....	C-220-222	YHSA10K38.....	B-12
YGIW34-550-2N.....	E-24	YH4434WCC.....	C-220-222	YHSA10K38RK.....	B-12
YGIW34-613-2N.....	E-24	YH4444.....	C-220-222	YHSA10K516.....	B-12
YGIW34-675-2N.....	E-24	YH4444WC.....	C-220-222	YHSA10K6.....	B-12
YGL29C2.....	E-6	YH4444WCC.....	C-220-222	YHSA10K6BF.....	B-43
YGL29C29.....	E-6	YH6C6C.....	C-220-222	YHSA10K6F.....	B-34
YGL2C2.....	E-6	YH6C6CWC.....	C-220-222	YHSA10K6LF.....	B-39
YGL34C2.....	E-6	YH6C6CWCC.....	C-220-222	YHSA10K8.....	B-12
YGL34C29.....	E-6	YH8C8C.....	C-220-222	YHSA10K8BF.....	B-43
YGL34C34.....	E-6	YH8C8CWC.....	C-220-222	YHSA10K8F.....	B-34
YGLR29C100.....	E-7	YH8C8CWCC.....	C-220-222	YHSA10K8FRK.....	B-34
YGLR29C12.....	E-7	YHD200.....	H-28-29	YHSA10K8LF.....	B-39
YGLR29C34.....	E-7	YHD200J1444.....	H-40	YHSA14K10.....	B-12
YGLR29C58.....	E-7	YHD250.....	H-28-29	YHSA14K10BF.....	B-43
YGLR34C100.....	E-7	YHD250J1444.....	H-40	YHSA14K10F.....	B-34
YGLR34C12.....	E-7	YHD3.....	H-28, H-31	YHSA14K10FRK.....	B-34
YGLR34C34.....	E-7	YHD300.....	H-28-29	YHSA14K10LF.....	B-39
YGLR34C58.....	E-7	YHD300J1496.....	H-40	YHSA14K10RK.....	B-12
YGS25.....	E-21	YHD350.....	H-28-29	YHSA14K14.....	B-12
YGS26.....	E-21	YHD350J1496.....	H-40	YHSA14K14FRK.....	B-34
YGS28.....	E-21	YHD4.....	H-28, H-31	YHSA14K14RK.....	B-12
YGS29.....	E-21	YHD400.....	H-28-29	YHSA14K38.....	B-12
YGS2C.....	E-21	YHD5.....	H-28, H-31	YHSA14K38RK.....	B-12

ALPHA-NUMERIC INDEX BY CATALOG NUMBER

YHSA14K516	B-12	YHSQ18F25X03RK	B-66	YNA43R15	I-4, I-13
YHSA14K6	B-12	YHSQ18M25X03	B-65	YNA43RT	I-5, I-13
YHSA14K6BF	B-43	YHSQ18M25X03RK	B-65	YNA43RT15	I-5, I-12
YHSA14K6F	B-34	YHSS10	B-56	YNA451R	I-4, I-12
YHSA14K6FRK	B-34	YHSS10RK	B-56	YNA451R15	I-4, I-13
YHSA14K6LF	B-39	YHSS14	B-56	YNA451RT	I-5, I-13
YHSA14K8	B-12	YHSS14RK	B-56	YNA451RT15	I-5, I-12
YHSA14K8BF	B-43	YHSS18	B-56	YNA49R	I-4, I-12
YHSA14K8F	B-34	YHSS18RK	B-56	YNA49R15	I-4, I-13
YHSA14K8FRK	B-34	YKA25R2N	H-35	YNA49RT	I-5, I-13
YHSA14K8LF	B-39	YKA262N	H-37	YNA49RT15	I-5, I-12
YHSA14K8RK	B-12	YKA26R2N	H-35	YNA52R	I-4, I-12
YHSA18K10	B-12	YKA27R2N	H-35	YNA52R15	I-4, I-13
YHSA18K10BF	B-43	YKA282N	H-37	YNA52RT	I-5, I-13
YHSA18K10F	B-34	YKA28R2N	H-35	YNA52RT15	I-5, I-13
YHSA18K10FRK	B-34	YKA2C2N	H-37	YNA54R	I-12
YHSA18K10LF	B-39	YKA2R2N	H-35	YNA54R15	I-12
YHSA18K10RK	B-12	YKA302N	H-37	YNA54RT	I-13
YHSA18K14	B-12	YKA30R2N	H-35	YNA54RT15	I-13
YHSA18K14RK	B-12	YKA321R2N	H-35	YNA56R	I-4, I-12
YHSA18K38	B-12	YKA33R2N	H-35	YNA56R15	I-4, I-12
YHSA18K38RK	B-12	YKA342N	H-37	YNA56RT	I-5, I-13
YHSA18K516	B-12	YKA34CA2N	H-35	YNA56RT15	I-5, I-13
YHSA18K516RK	B-12	YKA361R2N	H-35	YNA58R	I-4, I-12
YHSA18K6	B-12	YKA37R2N	H-35	YNA58R15	I-4, I-12
YHSA18K6BF	B-43	YKA391A2N	H-35	YNA58RT	I-5, I-13
YHSA18K6F	B-34	YKA442N	H-37	YNA58RT15	I-5, I-13
YHSA18K6FRK	B-34	YKA6C2N	H-37	YNA594R	I-12
YHSA18K6LF	B-39	YM1028	K-23	YNA594R15	I-12
YHSA18K6RK	B-12	YM1034	K-23	YNA594RT	I-13
YHSA18K8	B-12	YM1228	K-23	YNA594RT15	I-13
YHSA18K8BF	B-43	YM1234	K-23	YNA59R	I-4, I-12
YHSA18K8F	B-34	YM428	K-23	YNA59R15	I-4, I-12
YHSA18K8FRK	B-34	YM434	K-23	YNA59RT	I-5, I-13
YHSA18K8LF	B-39	YM628	K-23	YNA59RT15	I-5, I-13
YHSA18K8RK	B-12	YM634	K-23	YNA7M10T	I-15
YHSFQ10F25X03	B-66	YM828	K-23	YNA7M6T	I-15
YHSFQ10F25X03RK	B-66	YM834	K-23, I-12	YNA7M7T	I-15
YHSFQ14F25X03	B-66	YNA32R	I-4, I-12	YNA7M8T	I-15
YHSFQ14F25X03RK	B-66	YNA32R15	I-4, I-13	YNM428	K-24
YHSFQ18F25X03	B-66	YNA32RT	I-5, I-13	YNM434	K-24
YHSFQ18F25X03RK	B-66	YNA32RT15	I-5, I-12	YNM628	K-24
YHSQ10F25X03	B-66	YNA34R	I-4, I-12	YNM634	K-24
YHSQ10F25X03RK	B-66	YNA34R15	I-4, I-13	YNM828	K-24
YHSQ10M25X03	B-65	YNA34RT	I-5, I-13	YNM834	K-24
YHSQ10M25X03RK	B-65	YNA34RT15	I-5, I-12	YNS32RT	I-6, I-14
YHSQ14F11X02D	B-66	YNA36R	I-4, I-12	YNS34RT	I-6, I-14
YHSQ14F18X02D	B-66	YNA36R15	I-4, I-13	YNS36RT	I-6, I-14
YHSQ14F25X03	B-66	YNA36RT	I-5, I-13	YNS39RT	I-6, I-14
YHSQ14F25X03RK	B-66	YNA36RT15	I-5, I-12	YNS43RT	I-6, I-14
YHSQ14M25X03	B-65	YNA39R	I-4, I-12	YNS451RT	I-6, I-14
YHSQ14M25X03RK	B-65	YNA39R15	I-4, I-13	YNS49RT	I-6, I-14
YHSQ18F11X02D	B-66	YNA39RT	I-5, I-13	YNS52RT	I-6, I-14
YHSQ18F18X02D	B-66	YNA39RT15	I-5, I-12	YNS54RT	I-14
YHSQ18F25X03	B-66	YNA43R	I-4, I-12	YNS56RT	I-6, I-14

ALPHA-NUMERIC INDEX BY CATALOG NUMBER

YNS58RT.....	I-6, I-14	YPC40A40.....	H-25	YRB44U44TW.....	K-53
YNS594RT.....	I-14	YQE91.....	B-81	YRV2CV6CL.....	B-60
YNS59RT.....	I-6, I-14	YRA1CU1.....	H-82	YRV4CV6CL.....	B-60
YNTA245MRTACCC.....	I-23	YRA25A1.....	H-82	YRV6CV10L.....	B-60
YNTA36RTACCC.....	I-23	YRA25U.....	H-82	YRV6CV8CL.....	B-60
YNTA39RTACCC.....	I-23	YRA26U.....	H-82	YRV8CV10L.....	B-60
YNTA43RTACCC.....	I-23	YRA27U.....	H-82	YRV8CV14L.....	B-60
YNTA451RTACCC.....	I-23	YRA28U.....	H-82	YS10WAG1.....	C-177
YNTA49RTACCC.....	I-23	YRA4CU1.....	H-82	YS12AG1.....	C-177
YNTA52RTACCC.....	I-23	YRA6CU1.....	H-82	YS1C.....	C-160
YNU245MRACCC.....	I-24	YRA8CU1.....	H-82	YS1CA1.....	C-177
YNU36RACCC.....	I-24	YRAL1CU.....	H-82	YS1CLBOX.....	C-159
YNU39RACCC.....	I-24	YRAL4CU.....	H-82	YS1CT.....	C-161
YNU43RACCC.....	I-24	YRB1CU1TTN.....	K-52	YS25.....	C-160
YNU451RACCC.....	I-24	YRB1CU2TTN.....	K-52	YS25A1.....	C-177
YNU49RACCC.....	I-24	YRB25U2.....	C-215	YS25FXLTCKITC.....	C-175
YNU52RACCC.....	I-24	YRB25U25TTN.....	K-52	YS25LBOX.....	C-159
YOU32R.....	H-55	YRB25U2TTN.....	K-52	YS25LTCKITC.....	C-175
YOU33R.....	H-55	YRB25U3TTN.....	K-52	YS25T.....	C-161
YOU35R.....	H-55	YRB27U25.....	C-215	YS25UCG1.....	K-51
YOU361R.....	H-55	YRB27U25TW.....	K-52	YS26.....	C-160
YOU37R.....	H-55	YRB27U26.....	C-215	YS26A1.....	C-177
YOU39R.....	H-55	YRB2825T.....	K-55	YS26FXLTCKITC.....	C-175
YOU41R.....	H-55	YRB28U1TW.....	K-52	YS26LBOX.....	C-159
YOU421R.....	H-55	YRB28U25TW.....	K-52	YS26LTCKITC.....	C-175
YOU43R.....	H-55	YRB28U26.....	C-215	YS26T.....	C-161
YOU44R.....	H-55	YRB28U26TW.....	K-52	YS26UCG1.....	K-51
YOU453R.....	H-55	YRB28U28TW.....	K-52	YS27.....	C-160
YOU45R.....	H-55	YRB28U3TW.....	K-52	YS27A1.....	C-177
YOU48R.....	H-55	YRB29U28.....	C-215	YS27LBOX.....	C-159
YOU49R.....	H-55	YRB2U3TTN.....	K-52	YS27UCG1.....	K-51
YP25U25.....	H-24	YRB2U4.....	C-215	YS28.....	C-160
YP26AU2.....	H-24	YRB31U25TW.....	K-52	YS28A1.....	C-177
YP27AU2.....	H-24	YRB31U28.....	C-215	YS28LBOX.....	C-159
YP27AU26.....	H-24	YRB31U28TW.....	K-52	YS28LTCKITC.....	C-175
YP27AU4.....	H-24	YRB31U29.....	C-215	YS28T.....	C-161
YP28C28.....	H-22	YRB31U31TW.....	K-52	YS28UCG1.....	K-51
YP28U2.....	H-24	YRB3428T.....	K-55	YS29.....	C-160
YP28U26.....	H-24	YRB34U25TW.....	K-53	YS29A1.....	C-177
YP28U28.....	H-24	YRB34U28TW.....	K-53	YS29FXLTCKITC.....	C-175
YP29C26.....	H-22	YRB34U29TW.....	K-53	YS29LBOX.....	C-159
YP2C2.....	H-22	YRB34U30TW.....	K-53	YS29T.....	C-161
YP2U3.....	H-24	YRB34U31.....	C-215	YS2C.....	C-160
YPC26R8U.....	H-26	YRB34U31TW.....	K-53	YS2CA1.....	C-177
YPC28U26.....	H-25	YRB34U34TW.....	K-53	YS2CFXLTCKITC.....	C-175
YPC28U28.....	H-25	YRB36U31.....	C-215	YS2CLBOX.....	C-159
YPC28U4.....	H-25	YRB36U34.....	C-215	YS2CLTCKITC.....	C-175
YPC2A8U.....	H-26	YRB39U31TW.....	K-53	YS2CT.....	C-161
YPC33R26U.....	H-25	YRB39U34.....	C-215	YS2UCG1.....	K-51
YPC33R28R.....	H-25	YRB39U34TW.....	K-53	YS30.....	C-160
YPC33R33R.....	H-25	YRB39U36.....	C-215	YS30A1.....	C-177
YPC36A36.....	H-25	YRB39U39TW.....	K-53	YS30FX.....	C-169
YPC38R26U.....	H-25	YRB44U31TW.....	K-53	YS30L.....	C-159
YPC40A32.....	H-25	YRB44U34TW.....	K-53	YS30LFX.....	C-162
YPC40A36.....	H-25	YRB44U39TW.....	K-53	YS30T.....	C-161

ALPHA-NUMERIC INDEX BY CATALOG NUMBER

YS31.....	C-160	YS4CA1.....	C-177	YSE14HN.....	B-52
YS31A1.....	C-177	YS4CFXLTCKITC.....	C-175	YSE18H.....	B-54
YS31ACG1.....	K-51	YS4CLBOX.....	C-159	YSE18HBOX.....	B-54
YS31FX.....	C-169	YS4CT.....	C-161	YSE18HHS.....	B-55
YS31L.....	C-159	YS5C.....	C-160	YSE18HN.....	B-52
YS31LFX.....	C-162	YS5CLBOX.....	C-159	YSES10K.....	B-57
YS31LTCKITC.....	C-175	YS6C.....	C-160	YSES14K.....	B-57
YS31T.....	C-161	YS6CA1.....	C-177	YSES18K.....	B-57
YS32.....	C-160	YS6CFXLTCKITC.....	C-175	YSH2929.....	C-224
YS32A1.....	C-177	YS6CLBOX.....	C-159	YSH3429.....	C-224
YS32FX.....	C-169	YS6CT.....	C-161	YSH3434.....	C-224
YS32L.....	C-159	YS8C.....	C-160, C-169	YSH3931.....	C-224
YS32LFX.....	C-162	YS8CA1.....	C-177	YSH3939.....	C-224
YS34.....	C-160	YS8CFXLTCKITC.....	C-175	YSHG3429.....	E-14
YS34A1.....	C-177	YS8CLBOX.....	C-159, C-162	YSHG3434.....	E-14
YS34FX.....	C-169	YSA25R2N.....	H-36	YSHG3931.....	E-14
YS34FXLTCKITC.....	C-175	YSA26R2N.....	H-36	YSHG4429.....	E-14
YS34L.....	C-159	YSA28R2N.....	H-36	YSM10.....	B-58
YS34LFX.....	C-162	YSA2R2N.....	H-36	YSM14.....	B-58
YS34LTCKITC.....	C-175	YSA30R2N.....	H-36	YSM18.....	B-58
YS34T.....	C-161	YSA321R2N.....	H-36	YSM1C.....	B-58
YS36.....	C-160	YSA37R2N.....	H-36	YSM25.....	B-58
YS36A1.....	C-177	YSCM104.....	B-59, C-158	YSM26.....	B-58
YS36FX.....	C-169	YSCM133.....	B-59, C-158	YSM27.....	B-58
YS36L.....	C-159	YSCM167.....	B-59, C-158	YSM28.....	B-58
YS36LFX.....	C-162	YSCM17.....	B-59, C-158	YSM2C.....	B-58
YS38FX.....	C-169	YSCM212.....	B-59, C-158	YSM4C.....	B-58
YS38FXLTCKITC.....	C-175	YSCM231.....	B-59, C-158	YSM6C.....	B-58
YS38L.....	C-159	YSCM27.....	B-59, C-158	YSM8C.....	B-58
YS38LFX.....	C-162	YSCM42.....	B-59, C-158	YSP1CT.....	C-161
YS39.....	C-160	YSCM66.....	B-59, C-158	YSP25T.....	C-161
YS39A1.....	C-177	YSCM80.....	B-59, C-158	YSP26T.....	C-161
YS39AM1.....	C-177	YSD25R25R.....	H-48	YSP28T.....	C-161
YS39L.....	C-159	YSD26R25R.....	H-48	YSP29T.....	C-161
YS39LTCKITC.....	C-175	YSD26R26R.....	H-48	YSP2CT.....	C-161
YS39T.....	C-161	YSD26R2R.....	H-48	YSP30T.....	C-161
YS3C.....	C-160	YSD26R2W.....	H-48	YSP31T.....	C-161
YS3CL.....	C-159	YSD27R25R.....	H-48	YSP34T.....	C-161
YS40FX.....	C-169	YSD27R26R.....	H-48	YSP39T.....	C-161
YS40LFX.....	C-162	YSD27R27R.....	H-48	YSP4CT.....	C-161
YS42A1.....	C-177	YSD27R2R.....	H-48		C-186, C-196,
YS44.....	C-160	YSD27R2W.....	H-48	YSR10CFX12CLTCKITC.....	C-205
YS44A1.....	C-177	YSD28R25R.....	H-48		C-186, C-196,
YS44FX.....	C-169	YSD28R26R.....	H-48	YSR10CFX14CLTCKITC.....	C-205
YS44FXLTCKITC.....	C-175	YSD28R27R.....	H-48		C-185, C-194,
YS44L.....	C-159	YSD28R28R.....	H-48	YSR25FX2CFXLTCKITC.....	C-204
YS44LFX.....	C-162	YSD28R2R.....	H-48		C-185, C-194,
YS45A1.....	C-177	YSD28R2W.....	H-48	YSR25FX4CFXLTCKITC.....	C-204
YS46.....	C-160	YSE10.....	B-54		C-185, C-194,
YS46A1.....	C-177	YSE10BOX.....	B-54	YSR25FX6CFXLTCKITC.....	C-204
YS47A1.....	C-177	YSE10HHS.....	B-55		C-208, C-211,
YS48.....	C-160	YSE10HN.....	B-52	YSR25FX6CFXTCKITC.....	C-214
YS483A1.....	C-177	YSE14H.....	B-54		C-185, C-194,
YS48A1.....	C-177	YSE14HBOX.....	B-54	YSR25FX8CFXLTCKITC.....	C-204
YS4C.....	C-160	YSE14HHS.....	B-55		

ALPHA-NUMERIC INDEX BY CATALOG NUMBER

YSR26FX25FXLTCKITC.....	C-184, C-193, C-203	YSR3125FXTCKITC.....	C-208, C-210, C-213	YSR34FX28FXTCKITC.....	C-207, C-210, C-212
YSR26FX2CFXLTCKITC.....	C-184, C-194, C-203	YSR3126FXLTCKITC.....	C-183, C-191, C-201	YSR34FX28LTCKITC.....	C-182, C-190, C-200
YSR26FX4CFXLTCKITC.....	C-184, C-194, C-203	YSR3128FXLTCKITC.....	C-183, C-191, C-201	YSR34FX28TCKITC.....	C-207, C-210, C-212
YSR26FX6CFXLTCKITC.....	C-184, C-194, C-203	YSR3128LTCKITC.....	C-183, C-191, C-201	YSR34FX29FXLTCKITC.....	C-182, C-190, C-200
YSR26FX6CFXTCKITC.....	C-208, C-211, C-214	YSR3128TCKITC.....	C-207, C-210, C-213	YSR34FX2CFXLTCKITC.....	C-183, C-191, C-182, C-190,
YSR2825FXLTCKITC.....	C-184, C-192, C-202	YSR3129FXLTCKITC.....	C-183, C-191, C-200	YSR34FX31LTCKITC.....	C-199 C-183, C-191,
YSR2825FXTCKITC.....	C-208, C-211, C-213	YSR312CFXLTCKITC.....	C-183, C-191, C-201	YSR34FX4CFXLTCKITC.....	C-200 C-183, C-191,
YSR282CFXLTCKITC.....	C-184, C-192, C-202	YSR312CFXTCKITC.....	C-208, C-210, C-213	YSR34FX6CFXLTCKITC.....	C-183, C-191, C-200
YSR282CFXTCKITC.....	C-208, C-211, C-214	YSR314CFXLTCKITC.....	C-183, C-192, C-201	YSR38FX26FXLTCKITC.....	C-182, C-189, C-199
YSR284CFXLTCKITC.....	C-184, C-193, C-202	YSR316CFXLTCKITC.....	C-183, C-192, C-201	YSR38FX28FXLTCKITC.....	C-182, C-189, C-199
YSR286CFXLTCKITC.....	C-184, C-193, C-202	YSR32FX28FXLTCKITC.....	C-183, C-192, C-201	YSR38FX28LTCKITC.....	C-182, C-189, C-199
YSR286CFXTCKITC.....	C-208, C-211, C-214	YSR32FX28FXTCKITC.....	C-208, C-210, C-213	YSR38FX28TCKITC.....	C-207, C-209, C-212
YSR28FX25FXLTCKITC.....	C-184, C-193, C-203	YSR32FX29FXLTCKITC.....	C-183, C-192, C-201	YSR38FX29FXLTCKITC.....	C-181, C-189, C-198
YSR28FX26FXLTCKITC.....	C-184, C-193, C-203	YSR32FX29FXTCKITC.....	C-208, C-210, C-213	YSR38FX29LTCKITC.....	C-181, C-189, C-198
YSR28FX28LTCKITC.....	C-184, C-193, C-202	YSR3425FXLTCKITC.....	C-182, C-190, C-199	YSR38FX30LTCKITC.....	C-181, C-189, C-198
YSR28FX2CFXLTCKITC.....	C-184, C-193, C-203	YSR3425FXTCKITC.....	C-207, C-209, C-212	YSR38FX31LTCKITC.....	C-181, C-189, C-198
YSR28FX4CFXLTCKITC.....	C-184, C-193, C-203	YSR3426FXLTCKITC.....	C-182, C-190, C-199	YSR38FX31TCKITC.....	C-207, C-209, C-212
YSR29FX25FXLTCKITC.....	C-184, C-192, C-202	YSR3428LTCKITC.....	C-182, C-190, C-199	YSR38FX34FXLTCKITC.....	C-181, C-189, C-198
YSR29FX25FXTCKITC.....	C-208, C-210, C-213	YSR3428TCKITC.....	C-182, C-190, C-199	YSR38FX34LTCKITC.....	C-181, C-189, C-198
YSR29FX28LTCKITC.....	C-183, C-192, C-202	YSR3429FXLTCKITC.....	C-182, C-189, C-199	YSR3928FXLTCKITC.....	C-181, C-188, C-198
YSR29FX2CFXLTCKITC.....	C-184, C-192, C-202	YSR3431LTCKITC.....	C-182, C-189, C-199	YSR3928LTCKITC.....	C-181, C-188, C-198
YSR29FX2CFXTCKITC.....	C-208, C-211, C-213	YSR3431TCKITC.....	C-182, C-189, C-199	YSR3928TCKITC.....	C-207, C-209, C-212
YSR2CFX4CFXLTCKITC.....	C-185, C-194, C-204	YSR3434FXLTCKITC.....	C-182, C-189, C-199	YSR3929FXLTCKITC.....	C-181, C-188, C-198
YSR2CFX6CFXLTCKITC.....	C-185, C-195, C-204	YSR34FX25FXLTCKITC.....	C-183, C-190, C-200	YSR3929LTCKITC.....	C-181, C-188, C-198
YSR2CFX6CFXTCKITC.....	C-208, C-211, C-214	YSR34FX25FXTCKITC.....	C-207, C-210, C-213	YSR3930LTCKITC.....	C-181, C-188, C-198
YSR2CFX8CFXLTCKITC.....	C-185, C-195, C-204	YSR34FX26FXLTCKITC.....	C-182, C-190, C-200	YSR3931LTCKITC.....	C-181, C-188, C-198
YSR3125FXLTCKITC.....	C-183, C-191, C-201	YSR34FX28FXLTCKITC.....	C-182, C-190, C-200	YSR3931TCKITC.....	C-207, C-209, C-212

ALPHA-NUMERIC INDEX BY CATALOG NUMBER

YSR3934FXLTCKITC.....	C-181, C-188, C-197	YSS6RG2.....	H-49	YSV25L.....	B-49
YSR3934LTCKITC.....	C-180, C-188, C-197	YST2525.....	C-230	YSV25LBOX.....	B-49
YSR3938FXLTCKITC.....	C-180, C-188, C-197	YST2626.....	C-230	YSV25LFX.....	C-162
YSR3939LTCKITC.....	C-180, C-188, C-197	YST2825.....	C-230	YSV26FX.....	C-169
YSR44FX28FXLTCKITC.....	C-180, C-187, C-197	YST2828.....	C-230	YSV26L.....	B-49
YSR44FX28LTCKITC.....	C-180, C-187, C-197	YST282C.....	C-230	YSV26LBOX.....	B-49
YSR44FX29FXLTCKITC.....	C-180, C-187, C-197	YST2929.....	C-230	YSV26LFX.....	C-162
YSR44FX29LTCKITC.....	C-180, C-187, C-197	YST2C2C.....	C-230	YSV27FX.....	C-169
YSR44FX30LTCKITC.....	C-180, C-187, C-197	YST3131.....	C-230	YSV27L.....	B-49
YSR44FX31LTCKITC.....	C-180, C-187, C-197	YST3428.....	C-230	YSV27LBOX.....	B-49
YSR44FX31TCKITC.....	C-180, C-187, C-207, C-209, C-212	YST3434.....	C-230	YSV27LFX.....	C-162
YSR44FX34FXLTCKITC.....	C-180, C-187, C-197	YST3939.....	C-230	YSV28FX.....	C-169
YSR44FX34LTCKITC.....	C-180, C-187, C-197	YST4C4C.....	C-230	YSV28L.....	B-49
YSR44FX34TCKITC.....	C-180, C-187, C-197	YSU25A25A.....	H-47	YSV28LBOX.....	B-49
YSR44FX38FXLTCKITC.....	C-180, C-187, C-197	YSU25R25R.....	H-47	YSV28LFX.....	C-162
YSR44FX38LTCKITC.....	C-180, C-187, C-197	YSU25R2R.....	H-47	YSV29FX.....	C-169
YSR44FX38TCKITC.....	C-180, C-187, C-197	YSU25R2W.....	H-47	YSV29LFX.....	C-162
YSR44FX39LTCKITC.....	C-180, C-187, C-197	YSU25R4W.....	H-47	YSV2CFX.....	C-169
YSR44FX39TCKITC.....	C-180, C-187, C-197	YSU25R6W.....	H-47	YSV2CL.....	B-49
YSR4CFX10CLTCKITC.....	C-185, C-195, C-205	YSU2R2R.....	H-47	YSV2CLBOX.....	B-49
YSR4CFX6CFXLTCKITC.....	C-185, C-195, C-204	YSU2R2W.....	H-47	YSV2CLFX.....	C-162
YSR4CFX6CFXTCKITC.....	C-185, C-195, C-204	YSU2R4W.....	H-47	YSV3CFX.....	C-169
YSR4CFX8CFXLTCKITC.....	C-185, C-195, C-205	YSU2R6W.....	H-47	YSV3CLFX.....	C-162
YSR6CFX10CLTCKITC.....	C-185, C-195, C-205	YSU2R8W.....	H-47	YSV4CFX.....	C-169
YSR6CFX14CLTCKITC.....	C-185, C-195, C-205	YSU2W2W.....	H-47	YSV4CL.....	B-49
YSR6CFX8CFXLTCKITC.....	C-185, C-195, C-205	YSU2W4W.....	H-47	YSV4CLBOX.....	B-49
YSR8CFX10CLTCKITC.....	C-186, C-195, C-205	YSU2W6W.....	H-47	YSV4CLFX.....	C-162
YSR8CFX14CLTCKITC.....	C-186, C-195, C-205	YSU2W8W.....	H-47	YSV6CFX.....	C-169
YSS2R.....	H-49	YSU4W4W.....	H-47	YSV6CL.....	B-49
YSS4R.....	H-49	YSU4W6W.....	H-47	YSV6CLBOX.....	B-49
YSS6R.....	H-49	YSU4W8W.....	H-47	YSV6CLFX.....	C-162
		YSU6W6W.....	H-47	YSV8CL.....	B-49
		YSV10.....	B-48	YSV8CLBOX.....	B-49
		YSV1014G2.....	B-60	YTA25R2N.....	H-34
		YSV10BBOX.....	B-47	YTA262N.....	H-36
		YSV10BOX.....	B-48	YTA26R2N.....	H-34
		YSV10H.....	B-50	YTA27R2N.....	H-34
		YSV10HBOX.....	B-50	YTA282N.....	H-36
		YSV1214G1.....	B-60	YTA28R2N.....	H-34
		YSV14.....	B-48	YTA2C2N.....	H-36
		YSV1418.....	B-60	YTA2R2N.....	H-34
		YSV14BBOX.....	B-47	YTA321R2N.....	H-34
		YSV14BOX.....	B-48	YTA33R2N.....	H-34
		YSV14H.....	B-50	YTA342N.....	H-36
		YSV14HBOX.....	B-50	YTA361R2N.....	H-34
		YSV18.....	B-48	YTA37R2N.....	H-34
		YSV18BBOX.....	B-47	YTA391A2N.....	H-34
		YSV18BOX.....	B-48	YTA39R2N.....	H-34
		YSV18H.....	B-50	YTA43R2N.....	H-34
		YSV18HBOX.....	B-50	YTS160MRTAC5.....	I-20
		YSV1CFX.....	C-169	YTS165MRTAC5.....	I-20
		YSV1CL.....	B-49	YTS235MRTAC5.....	I-20
		YSV1CLBOX.....	B-49	YTS245MRTAC5.....	I-20
		YSV1CLFX.....	C-162	YTS301AT.....	I-11
		YSV25FX.....	C-169	YTS311AT.....	I-11

ALPHA-NUMERIC INDEX BY CATALOG NUMBER

YTS312E.....	I-17	YTS52RT48RS.....	I-3	YTW39RE15ACCCK4.....	I-18
YTS320RTACCC2.....	I-20	YTS52RT48RSHT.....	I-7	YTW43RE15ACCCK4.....	I-18
YTS32RT33RS.....	I-3	YTS52RT521RS.....	I-3	YTW451RE15ACCCK4.....	I-18
YTS32RT33RSHT.....	I-7	YTS52RT521RSHT.....	I-7	YTW470MRE15ACK5.....	I-18
YTS32RT34RS.....	I-3	YTS52RT59RS.....	I-3	YTW48RE15ACCCK4.....	I-19
YTS32RT34RSHT.....	I-7	YTS52RT59RSHT.....	I-7	YTW52RE15ACCCK4.....	I-19
YTS32RTACCC2.....	I-20	YTS52RTACCC2.....	I-20	YTW530MRE15ACK5.....	I-18
YTS330MRTAC5.....	I-20	YTS530MRTAC5.....	I-20	YTW545MRE15ACK5.....	I-19
YTS331AT.....	I-11	YTS545MRTAC5.....	I-20	YTW549RE15ACCCK4.....	I-19
YTS34RT34RS.....	I-3	YTS549RT521RS.....	I-3	YTW56RE15ACCCK4.....	I-19
YTS34RT34RSHT.....	I-7	YTS549RT521RSHT.....	I-7	YTW570MRE15ACK5.....	I-19
YTS351AT.....	I-11	YTS549RT549RS.....	I-3	YTW590MRE15ACK5.....	I-19
YTS361AT.....	I-11	YTS549RT549RSHT.....	I-7	YTW59RE15ACCCK4.....	I-19
YTS36RT362RS.....	I-3	YTS549RT59RS.....	I-3	YTW610MRE15ACK5.....	I-19
YTS36RT362RSHT.....	I-7	YTS549RT59RSHT.....	I-7	YTW690MRE15ACK5.....	I-19
YTS36RT36RS.....	I-3	YTS549RTACCC2.....	I-20	YTW710MRE15ACK5.....	I-19
YTS36RT36RSHT.....	I-7	YTS56RT59RS.....	I-3	YTW760MRE15ACK5.....	I-19
YTS36RTACCC2.....	I-20	YTS56RT59RSHT.....	I-7	YTW780MRE15ACK5.....	I-19
YTS375E.....	H-69, I-17	YTS56RTACCC2.....	I-20	Z104C4034.....	K-21
YTS391AT.....	I-11	YTS570MRTAC5.....	I-20	Z104C4434.....	K-21
YTS39AT.....	I-11	YTS58RT48RS.....	I-3	Z144C4840.....	K-21
YTS39RT43RS.....	I-3	YTS58RT48RSHT.....	I-7	Z1C28.....	K-20
YTS39RT43RSHT.....	I-7	YTS59RT521RS.....	I-3	Z1C29.....	K-19-20
YTS39RTACCC2.....	I-20	YTS59RT521RSHT.....	I-7	Z1C30.....	K-19-20
YTS431AT.....	I-11	YTS59RT59RS.....	I-3	Z1C32.....	K-19-20
YTS438E.....	H-69, I-17	YTS59RT59RSHT.....	I-7	Z1C34.....	K-19
YTS43RT43RS.....	I-3	YTS59RTACCC2.....	I-20	Z2528.....	K-19-20
YTS43RT43RSHT.....	I-7	YTS610MRTAC5.....	I-20	Z2529.....	K-19-20
YTS43RTACCC2.....	I-20	YTS690MRTAC5.....	I-20	Z2530.....	K-19-20
YTS445AT.....	I-11	YTS710MRTAC5.....	I-20	Z2532.....	K-19-20
YTS451AT.....	I-11	YTS760MRTAC5.....	I-20	Z2534.....	K-19-20
YTS451RT449RS.....	I-3	YTS780MRTAC5.....	I-20	Z2536.....	K-20
YTS451RT449RSHT.....	I-7	YTTAG388.....	E-26	Z2628.....	K-20
YTS451RT481RS.....	I-3	YTU25R25R.....	H-33	Z2629.....	K-19-20
YTS451RT481RSHT.....	I-7	YTU25R4W.....	H-33	Z2630.....	K-19-20
YTS451RT48RS.....	I-3	YTU26R26R.....	H-33	Z2632.....	K-19-20
YTS451RT48RSHT.....	I-7	YTU27R27R.....	H-33	Z2634.....	K-19-20
YTS451RTACCC2.....	I-20	YTU28R28R.....	H-33	Z2636.....	K-20
YTS457AT.....	I-11	YTU30R30R.....	H-33	Z2640.....	K-20
YTS463AT.....	I-11	YTU321R26R.....	H-33	Z2728.....	K-19-20
YTS470MRTAC5.....	I-20	YTU321R27R.....	H-33	Z2729.....	K-20
YTS47AT.....	I-11	YTU321R28R.....	H-33	Z2730.....	K-19-20
YTS484AT.....	I-11	YTU321R321R.....	H-33	Z2732.....	K-19-20
YTS486AT.....	I-11	YTU33R26R.....	H-33	Z2734.....	K-19-20
YTS48AT.....	I-11	YTU33R28R.....	H-33	Z2736.....	K-20
YTS48RT481RS.....	I-3	YTU33R33R.....	H-33	Z2740.....	K-20
YTS48RT481RSHT.....	I-7	YTW160MRE15ACK6.....	I-18	Z2828.....	K-19
YTS48RT48RS.....	I-3	YTW165MRE15ACK6.....	I-18	Z2829.....	K-19-20
YTS48RT48RSHT.....	I-7	YTW235MRE15ACK5.....	I-18	Z2830.....	K-19-20
YTS48RTACCC2.....	I-20	YTW245MRE15ACK6.....	I-18	Z2832.....	K-19-20
YTS49RT483RS.....	I-3	YTW320RE15ACCC4.....	I-18	Z2834.....	K-19-20
YTS49RT483RSHT.....	I-7	YTW320RE15ACCCK4.....	I-18	Z2836.....	K-20
YTS49RT48RS.....	I-3	YTW32RE15ACCCK4.....	I-18	Z2840.....	K-20
YTS49RT48RSHT.....	I-7	YTW330MRE15ACK6.....	I-18	Z2844.....	K-20
YTS500E.....	I-17	YTW36RE15ACCCK4.....	I-18	Z28NR.....	K-18-21

ALPHA-NUMERIC INDEX BY CATALOG NUMBER

Z2929.....	K-19-20	Z3644.....	K-19-20	ZM425B.....	K-10
Z2930.....	K-19-20	Z36NR.....	K-18-19, K-21	ZM430.....	K-10
Z2932.....	K-19-20	Z3740.....	K-19	ZM430B.....	K-10
Z2934.....	K-19-20	Z3744.....	K-19	ZM615.....	K-10
Z2936.....	K-19-20	Z3840.....	K-19	ZM625.....	K-10
Z2940.....	K-19-20	Z3844.....	K-19	ZM625B.....	K-10
Z2944.....	K-20	Z3940.....	K-19	ZM630.....	K-10
Z29NR.....	K-18-21	Z3944.....	K-19	ZM630B.....	K-10
Z29P.....	K-17	Z3C28.....	K-20	ZM815.....	K-10
Z2C28.....	K-19-20	Z4040.....	K-19	ZM825.....	K-10
Z2C29.....	K-19-20	Z4044.....	K-19	ZM825B.....	K-10
Z2C30.....	K-19	Z40NR.....	K-18-21	ZM830.....	K-10
Z2C32.....	K-19	Z40NRA.....	K-18-19, K-21	ZM830B.....	K-10
Z2C34.....	K-19	Z40P.....	K-17	ZMDN320.....	K-16
Z2MLDN20.....	K-15	Z4144.....	K-19	ZMDN320B.....	K-16
Z2MLDN230.....	K-15	Z4244.....	K-19	ZMDN325.....	K-16
Z2MLDN230B.....	K-15	Z4344.....	K-19	ZMDN420.....	K-16
Z2MLDN40.....	K-15	Z4444.....	K-19	ZMDN420B.....	K-16
Z2MLDN430.....	K-15	Z44NR.....	K-18-21	ZMDN425.....	K-16
Z2MLDN430B.....	K-15	Z45NR.....	K-21	ZMDN520.....	K-16
Z2MLDN620.....	K-15	Z4646.....	K-19	ZMDN520B.....	K-16
Z2MLDN630.....	K-15	Z46NR.....	K-18-19, K-21	ZMDN525.....	K-16
Z2MLDN630B.....	K-15	Z4747.....	K-19	ZMDN620.....	K-16
Z3030.....	K-19	Z47NR.....	K-18-19, K-21	ZMDN620B.....	K-16
Z3032.....	K-19	Z48NR.....	K-21	ZMDN625.....	K-16
Z3034.....	K-19	Z4C28.....	K-19	ZMLDN115.....	K-13
Z3036.....	K-19	Z4C29.....	K-19	ZMLDN120.....	K-13
Z3040.....	K-19	Z4C30.....	K-19	ZMLDN120B.....	K-13
Z30NR.....	K-18-21	Z6C28.....	K-19	ZMLDN125.....	K-14
Z3132.....	K-19	Z6C29.....	K-19	ZMLDN125B.....	K-14
Z3134.....	K-19	Z6C30.....	K-19	ZMLDN130.....	K-14
Z3136.....	K-19	Z72C3029.....	K-21	ZMLDN130B.....	K-14
Z3140.....	K-19	Z88C3429.....	K-21	ZMLDN215.....	K-13
Z3232.....	K-19-20	ZM1015.....	K-10	ZMLDN220.....	K-13
Z3234.....	K-19-20	ZM1025.....	K-10	ZMLDN220B.....	K-13
Z3236.....	K-19-20	ZM1025B.....	K-10	ZMLDN225.....	K-14
Z3240.....	K-19-20	ZM1030.....	K-10	ZMLDN225B.....	K-14
Z3244.....	K-20	ZM1030B.....	K-10	ZMLDN230.....	K-14
Z32NR.....	K-18-21	ZM1215.....	K-10	ZMLDN230B.....	K-14
Z3334.....	K-19-20	ZM1225.....	K-10	ZMLDN315.....	K-13
Z3336.....	K-19-20	ZM1225B.....	K-10	ZMLDN320.....	K-13
Z3340.....	K-19-20	ZM1230.....	K-10	ZMLDN320B.....	K-13
Z3344.....	K-20	ZM1230B.....	K-10	ZMLDN325.....	K-14
Z3434.....	K-19-20	ZM1415.....	K-10	ZMLDN325B.....	K-14
Z3436.....	K-19-20	ZM1425.....	K-10	ZMLDN330.....	K-14
Z3440.....	K-19-20	ZM1425B.....	K-10	ZMLDN330B.....	K-14
Z3444.....	K-19-20	ZM1430.....	K-10	ZMLDN415.....	K-13
Z34NR.....	K-18-21	ZM1430B.....	K-10	ZMLDN420.....	K-13
Z34NRB.....	K-18-19, K-21	ZM1615.....	K-10	ZMLDN420B.....	K-13
Z34P.....	K-17	ZM1625.....	K-10	ZMLDN425.....	K-14
Z3536.....	K-19	ZM1625B.....	K-10	ZMLDN425B.....	K-14
Z3540.....	K-19	ZM1630.....	K-10	ZMLDN430.....	K-14
Z3544.....	K-19	ZM1630B.....	K-10	ZMLDN430B.....	K-14
Z3636.....	K-19-20	ZM415.....	K-10	ZMLDN515.....	K-13
Z3640.....	K-19-20	ZM425.....	K-10	ZMLDN520.....	K-13

ALPHA-NUMERIC INDEX BY CATALOG NUMBER

ZMLDN520B.....	K-13	ZMTDN1015.....	K-17
ZMLDN525.....	K-14	ZMTDN1025.....	K-17
ZMLDN525B.....	K-14	ZMTDN815.....	K-17
ZMLDN530.....	K-14	ZMTDN820.....	K-17
ZMLDN530B.....	K-14	ZMX1015.....	K-12
ZMLDN615.....	K-13	ZMX1025.....	K-12
ZMLDN620.....	K-13	ZMX1025B.....	K-12
ZMLDN620B.....	K-13	ZMX1030.....	K-12
ZMLDN625.....	K-14	ZMX1030B.....	K-12
ZMLDN625B.....	K-14	ZMX1215.....	K-12
ZMLDN630.....	K-14	ZMX1225.....	K-12
ZMLDN630B.....	K-14	ZMX1225B.....	K-12
ZMS29.....	K-21	ZMX1230.....	K-12
ZMS34.....	K-21	ZMX1230B.....	K-12
ZMS40.....	K-21	ZMX1415.....	K-12
ZMT1115.....	K-11	ZMX1425.....	K-12
ZMT1125.....	K-11	ZMX1425B.....	K-12
ZMT1125B.....	K-11	ZMX1430.....	K-12
ZMT1130.....	K-11	ZMX1430B.....	K-12
ZMT1130B.....	K-11	ZMX1615.....	K-12
ZMT1315.....	K-11	ZMX1625.....	K-12
ZMT1325.....	K-11	ZMX1625B.....	K-12
ZMT1325B.....	K-11	ZMX1630.....	K-12
ZMT1330.....	K-11	ZMX1630B.....	K-12
ZMT1330B.....	K-11	ZMX1815.....	K-12
ZMT150B.....	K-11	ZMX1825.....	K-12
ZMT1515.....	K-11	ZMX1825B.....	K-12
ZMT1525.....	K-11	ZMX1830.....	K-12
ZMT1525B.....	K-11	ZMX1830B.....	K-12
ZMT1530.....	K-11	ZMX415.....	K-12
ZMT1715.....	K-11	ZMX425.....	K-12
ZMT1725.....	K-11	ZMX425B.....	K-12
ZMT1725B.....	K-11	ZMX430.....	K-12
ZMT1730.....	K-11	ZMX430B.....	K-12
ZMT1730B.....	K-11	ZMX615.....	K-12
ZMT315.....	K-11	ZMX625.....	K-12
ZMT325.....	K-11	ZMX625B.....	K-12
ZMT325B.....	K-11	ZMX630.....	K-12
ZMT330.....	K-11	ZMX630B.....	K-12
ZMT330B.....	K-11	ZMX815.....	K-12
ZMT515.....	K-11	ZMX825.....	K-12
ZMT525.....	K-11	ZMX825B.....	K-12
ZMT525B.....	K-11	ZMX830.....	K-12
ZMT530.....	K-11	ZMX830B.....	K-12
ZMT530B.....	K-11		
ZMT715.....	K-11		
ZMT725.....	K-11		
ZMT725B.....	K-11		
ZMT730.....	K-11		
ZMT730B.....	K-11		
ZMT915.....	K-11		
ZMT925.....	K-11		
ZMT925B.....	K-11		
ZMT930.....	K-11		
ZMT930B.....	K-11		

This Page Intentionally Left Blank

This Page Intentionally Left Blank

This Page Intentionally Left Blank

This Page Intentionally Left Blank

This Page Intentionally Left Blank

This Page Intentionally Left Blank

This Page Intentionally Left Blank

STANDARD TERMS AND CONDITIONS OF SALE

1. **Applicability.** BURNDY, LLC ("Seller") hereby offers for sale to the buyer named on the face hereof ("Buyer") the products listed on the face hereof (the "Products") on the express condition that Buyer agrees to accept and be bound by the terms and conditions set forth herein. Any provisions contained in any document issued by Buyer are expressly rejected and if these terms and conditions differ from the terms of Buyer's offer, this document shall be construed as a counter offer and shall not be effective as an acceptance of Buyer's document. Buyer's receipt of Products provided hereunder will constitute Buyer's acceptance of these terms and conditions. This is the complete and exclusive statement of the contract between Seller and Buyer with respect to Buyer's purchase of the Products. No waiver, consent, modification, amendment or change of the terms contained herein shall be binding unless in writing and signed by Seller and Buyer. Seller's failure to object to terms contained in any subsequent communication from Buyer will not be a waiver or modification of the terms set forth herein. All orders are subject to acceptance in writing by an authorized representative of Seller.

2. **Prices.** Prices in written quotations issued by Seller are valid for thirty (30) days. All other prices are subject to change at any time, unless otherwise expressly agreed by Seller. Any prices shown in published literature are maintained as a general source of information and are not quotations or offers to sell. Seller reserves the right to make corrections due to typographical, clerical or engineering errors or due to incomplete or inaccurate information from Buyer. Prices for accepted orders may change due to customer order, quantity, material or engineering changes.

3. **Taxes.** Prices do not include any state, local, use or excise taxes, duties or other charges now or hereafter imposed for which Seller may be liable as a result of the sale, use or delivery of the Products ("Taxes"). In the absence of proper evidence of exemption supplied by Buyer to Seller, Buyer will be responsible for any and all such Taxes.

4. **Minimum Order Quantity.** Orders are subject to standard package sizes.

5. **Payment Terms.** Subject to credit approval, unless otherwise specified on the quotation or invoice, payment terms shall be Net 30 days from the date of invoice. All payment shall be in US dollars. If Buyer fails to pay any amounts when due, Buyer agrees to pay Seller interest thereon at a periodic rate of the greater of the maximum percentage allowed by law or 1% per month. Buyer will also be responsible for all costs and expenses, including attorneys' fees incurred by Seller in collecting any overdue amounts or otherwise enforcing Seller's rights hereunder.

6. **Shipping and Delivery.** Estimated delivery dates are provided in the quotation or acknowledgment, and shall not represent a fixed or guaranteed ship date. Unless otherwise agreed to by Seller, Seller reserves the right to ship at its convenience and/or ship and invoice for partial orders. All deliveries are FCA Seller's location (INCOTERMS 2010); freight may be pre-paid and added to invoice. Seller may stop delivery of Products in transit and/or withhold shipments in whole or in part if Buyer fails to make any payment to Seller when due or otherwise fails to perform under these terms. In the event of a delay due to any cause beyond Seller's reasonable control, Seller reserves the right to terminate the order or to reschedule the shipment within a reasonable period of time, and Seller shall not be responsible for any damages resulting from delay. If delivery is delayed due to any cause within Buyer's control, Seller may place the Products in storage at Buyer's risk and expense and for Buyer's account.

7. **Title and Risk of Loss.** Title and risk of loss to the Products shall pass to Buyer upon delivery by Seller to the carrier.

8. **Cancellations. Returns.** Orders may not be cancelled or modified once accepted by Seller unless agreed upon in writing by Seller. Any cancellation or return of Products shall be subject to Seller's return policies, and may be subject to Seller's cancellation or restocking fee. Seller's restocking policy is available upon request. Non-stock or special order items are non-cancellable and non-returnable. No returns shall be permitted without a Return Material Authorization (RMA).

9. **Packaging. Allocation.** All Products are packaged in accordance with Seller's standard packaging, unless otherwise agreed upon by the parties. Additional or modified packaging requirements may result in an increase in price. In the event

of inability for any reason to supply the total demand for the materials or Products specified, Seller may allocate its available supply among any or all purchasers, at its discretion and without liability for failure of performance that may result therefrom.

10. **Tooling.** Any tooling required for an initial order will be billed to Buyer. Any Non-Recurring Engineering (NRE) charges invoiced by Seller shall not be deemed to grant any right, title or interest in any tools, dies, jigs, fixtures and items of like nature, or in any design, engineering, trade secret, patent or other proprietary rights embodied in the tooling, upon Buyer's payment of such charges and such items shall at all times be, and remain, the property of Seller.

11. **Warranty.**

11.1 Seller warrants that the Products will perform substantially in accordance with Seller's published specifications (or other applicable specifications as agreed upon in writing by Seller) and will be free from defects in material and workmanship, when subject to normal, proper and intended usage by properly trained personnel, for the following warranty period, which shall begin on the date of shipment by Seller (the "Warranty Period"): (a) **Tools:** The Warranty Period shall be as specified in the product literature or, if no period is so specified, five (5) years; (b) **UL Listed Products:** the Warranty Period shall be two (2) years; (c) for all other products, the Warranty Period shall be 30 days. (d) **For UL Certified Compression Connection (the "Connection"),** provided that the Connection is made using (i) a recommended and properly calibrated tool, (ii) a recommended and properly calibrated die set, and (iii) a compression connector manufactured by Seller and specified in the UL Listing for such connection, and Buyer otherwise complies with the requirements set forth in the applicable UL Listing, Seller warrants that the Connection will conform with the UL Listing for a period of 5 years from the date the Connection is made, provided such Connection is made within one year of the purchase of the connector used in the Connection.

11.2 **Remedies.** During the Warranty Period, Seller agrees to repair or replace, at Seller's option, Products in order to ensure that the Products perform in accordance with the applicable specifications provided that Buyer shall (a) promptly notify Seller in writing upon the discovery of any defect, which notice shall include the product model and serial number (if applicable) and details of the warranty claim; and (b) after Seller's review, Seller will provide Buyer with a RMA. Buyer may return the defective Products to Seller with all costs prepaid by Buyer. In case of a defect in the Connection during the Warranty Period, Seller shall replace the connector used to make such connection. All replaced parts shall become the property of Seller. Shipment to Buyer of repaired or replacement Products shall be made in accordance with the Delivery provisions herein. Any consumables, including but not limited to, bulbs and batteries, are excluded from warranty. Seller will have no obligation to make repairs, replacements or corrections which are defective as a result of: (i) normal wear and tear, (ii) Buyer's misuse, fault or negligence, (iii) use of the Products in a manner for which they were not designed, or (iv) improper storage, maintenance, installation and handling of the Products, and in the case of the Connection, Buyer's failure to use Seller's Tool, connector and die set Products, as specified in 11.1 (d) above, and in accordance with the requirements of the UL Listing for such Connection. If Seller determines that Products for which Buyer has requested warranty services are not covered by the warranty hereunder, Buyer shall pay or reimburse Seller for all costs of investigating and responding to such request at Seller's then prevailing time and materials rates. If Seller provides repair services or replacement parts that are not covered by this warranty, Buyer shall pay Seller therefor at Seller's then prevailing time and materials rates. THE OBLIGATIONS CREATED BY THIS WARRANTY TO REPAIR OR REPLACE A DEFECTIVE PRODUCT SHALL BE THE SOLE REMEDY OF BUYER IN THE EVENT OF A DEFECTIVE PRODUCT OR SERVICE. EXCEPT AS EXPRESSLY PROVIDED HEREIN, SELLER DISCLAIMS ALL OTHER WARRANTIES, WHETHER EXPRESS OR IMPLIED, ORAL OR WRITTEN, WITH RESPECT TO THE PRODUCTS, INCLUDING WITHOUT LIMITATION ALL IMPLIED WARRANTIES OF MERCHANTABILITY OR FITNESS FOR ANY PARTICULAR PURPOSE. In no event will Seller's aggregate liability under warranty exceed the price paid by Buyer for the defective Product. Products supplied by Seller that are obtained by Seller from a third party supplier are not warranted by Seller. At

STANDARD TERMS AND CONDITIONS OF SALE

its discretion and to the extent Seller is permitted, Seller agrees to assign to Buyer any warranty rights in such Product that Seller may have from the third party supplier. The Warranty Period for replacement Products shall be the remainder of the original Warranty Period.

12. Intellectual Property. Seller's specifications and design of the Products and any developments, improvements and intellectual property created under this order, whether made solely by a party or jointly by Buyer and Seller ("Intellectual Property") shall be owned by Seller. Buyer is not granted any interest, right or license with respect to any such intellectual property, except to the extent required to use the Products for the purpose for which it is specifically provided to Buyer in accordance with these terms and conditions.

13. Software. With respect to any software incorporated in or forming a part of the Products hereunder ("Software"), Seller and Buyer intend and agree that such Software is being licensed and not sold. Notwithstanding anything to the contrary contained herein, Seller or its licensor, as the case may be, retains all rights and interest in Software. Seller hereby grants to Buyer a royalty-free, non-exclusive, nontransferable license, without power to sublicense, to use Software provided hereunder solely in connection with the Products and to use the related documentation solely for Buyer's own internal business purposes. This license will terminate when Buyer's lawful possession of the Products ceases, unless earlier terminated as provided herein. Buyer agrees to not sell, transfer, license, loan or otherwise make available in any form Software to any third party. Buyer may not disassemble, decompile or reverse engineer, copy, modify, enhance or otherwise change or supplement the Software without Seller's prior written consent. Seller may terminate this license if Buyer fails to comply with any term or condition herein.

14. Indemnity. By Seller. Seller agrees to indemnify, defend and save Buyer from and against any and all damages, liabilities, actions, causes of action, suits, claims, demands, losses, costs and expenses (including without limitation reasonable attorney's fees) ("Claims") for (i) personal injury or death or damage to real property to the extent caused by the negligence or willful misconduct of Seller, its employees, agents or representatives in connection with the performance of services at Buyer's premises and (ii) claims that a Product infringes any valid United States patent, copyright or trade secret. Notwithstanding the foregoing, Seller shall have no liability to the extent any such Claims are caused by either (i) the negligence or willful misconduct of Buyer or third party, (ii) use of a Product in combination with equipment or software not supplied by Seller where the Product would not itself be infringing, (iv) Seller's compliance with Buyer's designs, specifications or instructions, (v) use of the Product in an application or environment for which it was not designed or (vi) service, installation or modification of any Product except by Seller. Buyer shall provide Seller prompt written notice of any Claims and Seller shall have the right to assume exclusive control of the defense of such claim or, at the option of the Seller, to settle the same. Buyer agrees to cooperate reasonably with Seller in connection with the performance by Seller of its obligations in this Section. Notwithstanding the above, Seller's infringement related indemnification obligations shall be extinguished and relieved if Seller, at its discretion and at its own expense (a) procures for Buyer the right, at no additional expense to Buyer, to continue using the Product; (b) replaces or modifies the Product so that it becomes non-infringing, provided the modification or replacement does not adversely affect the specifications of the Product or (c) if neither of the preceding is reasonably practicable, refund the purchase price for the Product. THE FOREGOING INDEMNIFICATION PROVISION STATES SELLER'S ENTIRE LIABILITY TO BUYER FOR THE CLAIMS DESCRIBED HEREIN.

By Buyer. Buyer shall indemnify, defend and hold harmless Seller from and against any and all Claims to the extent arising from or in connection with (i) the negligence or willful misconduct of Buyer; (ii) use of a Product in combination with equipment or software not supplied by Seller where the Product itself would not be infringing; (iii) Seller's compliance with designs, specifications or instructions supplied to Seller by Buyer; (iv) use of a Product in an application or environment for which it was not designed; or (v) modifications of a Product by anyone other than Seller.

15. Limitation of Liability. Notwithstanding anything to the contrary contained herein, Seller's aggregate liability for any claim of any kind shall not exceed the price paid by Buyer for the products giving rise to such claim. IN NO EVENT SHALL SELLER BE LIABLE FOR SPECIAL, INCIDENTAL, LIQUIDATED, OR CONSEQUENTIAL DAMAGES HOWSOEVER ARISING OUT OF SELLER'S PERFORMANCE (OR NON- PERFORMANCE) OF THE CONTRACT AND NOTWITHSTANDING WHETHER BUYER MAY HAVE BEEN ADVISED OR IS ADVISED OF THE POSSIBILITY OF SUCH DAMAGES.

16. Compliance with Laws. Export Laws. Seller agrees to observe and comply with all applicable federal, state and local laws, rules, regulations, including but not limited to all applicable laws, regulations, laws, treaties, and agreements relating to the export, re-export, and import of any Product or part of Product. Buyer shall not, without first obtaining any required license to do so from the appropriate U.S. government agency; (i) export or re-export any Product or part of a Product, or (ii) export, re-export, distribute or supply any Product or part of a Product to any restricted or embargoed country or to a person or entity whose privilege to participate in exports has been denied or restricted by the U.S. government. At Seller's request, Buyer will provide information on the end user and end use of any Product or part thereof exported or to be exported by Buyer. Buyer shall cooperate fully with Seller in any audit or inspection related to applicable export or import control laws or regulations, and shall indemnify and hold Seller harmless from, or in connection with, any violation of this section by Buyer or its employees, consultants, or agents.

17. Miscellaneous. (a) Any legal claim shall be controlled under the laws of the state of the Seller's primary place of business. Seller and Buyer agree to accept and be bound by the exclusive jurisdiction of the federal and state courts thereof. The application to this Agreement of the U.N. Convention on Contracts for the International Sale of Goods is hereby expressly excluded.

(b) In the event that any one or more provisions contained in these terms shall be held by a court of competent jurisdiction to be invalid, illegal or unenforceable in any respect, the validity, legality and enforceability of the remaining provisions contained herein shall remain in full force and effect.

(c) Seller's failure to enforce or waiver of a breach of any provision contained herein shall not constitute a waiver of any other breach or of such provision.

(d) Any notice or communication required or permitted hereunder shall be in writing and shall be deemed received when personally delivered or three (3) business days after being sent by certified mail, postage prepaid, to a party at the address specified herein or at such other address as either party may from time to time designate to the other. (e) Buyer may not assign or delegate any rights or obligations without Seller's prior written consent. (f) Seller reserves the right to place a Lien and notifications of liens should Seller not be paid for equipment provided hereunder.

(g) Buyer agrees that all pricing, discounts, data, design and technical information, operations/maintenance manuals, testing procedures, drawings, schematics and any other information regarding the Products or Seller's processes provided by Seller to Buyer are the confidential and proprietary information of Seller. Buyer agrees to (a) keep such information confidential and not disclose such information to any third party, and (b) use such information solely for Buyer's internal purposes and in connection with the Products supplied hereunder. Nothing herein shall restrict the use of information available to the general public.



This Page Intentionally Left Blank