

OVERVIEW

The nLight® AIR rPODBA is a wireless, battery-powered wall switch including toggle and/or raise lower features with optional multi-pole control. It provides a user with local control of a lighting zone. A true wire-free switch, these single gang decorator style devices have soft-click buttons and a green LED indicator for each button. The wall switches communicate with other nLight AIR devices via radio frequency (RF). A battery-powered wall switch can work with any nLight AIR enabled fixture or power pack to provide toggle switch operation. Wall switches with the DX option have the added ability to adjust the level of any nLight AIR controlled dimmable light fixture.

FEATURES

- Powered with three off-the-shelf lithium AAA batteries and rated for 10 years of normal use, minimizing battery replacement. (Battery replacement with alkaline batteries does not guarantee a 10-year run time.)
- Communicates with nLight AIR devices via radio frequency (RF) in the 900MHz spectrum
- Soft-click push-button control
- Single pole or two pole on/off control with optional raise/lower option ("DX" option)
- 2 or 4 preset scene control fully configurable via CLAIRITY™+ mobile app
- Maximum of 4 total preset scenes per nLight AIR group
- Batteries are included and preinstalled, allowing for a simple unbox and mount installation
- Wireless multi location dimming

CUSTOM BUTTON ENGRAVING

- Custom lettering for units can be specified and ordered at: [nGrave Form](#)
- To ensure color uniformity, ordering templates facilitate specifying all buttons on a unit as custom lettered. Replacing single buttons is not recommended
- Custom buttons will ship separately and require field installation

Warranty

Five-year limited warranty. This is the only warranty provided and no other statements in this specification sheet create any warranty of any kind. All other express and implied warranties are disclaimed. Complete warranty terms located at: www.acuitybrands.com/support/warranty/terms-and-conditions

Note: Actual performance may differ as a result of end-user environment and application. Specifications subject to change without notice.



This item is an A+ capable component, which has been designed and tested to provide out-of-the-box luminaire compatibility with simple commissioning, when included as part of an A+ Certified™ Solution.

To learn more about A+, visit www.acuitybrands.com/aplus.



Items marked by a shaded background qualify for the Design Select program and ship in 15 days or less. To learn more about Design Select, visit www.acuitybrands.com/designselect.

*See ordering tree for details

nLight, nLight AIR and the Acuity Controls and Acuity Brands logos are trademarks of Acuity Brands. Bluetooth is a trademark of Bluetooth SIG, Inc. used by Acuity Brands under license. Apple and the Apple logo are trademarks of Apple Inc. Android and Google Play are trademarks of Google, Inc. Other trademarks are property of their respective owners.



nLight® AIR rPODBA: Battery-Powered Wall Switch



Note: nLight® AIR devices are only compatible with other nLight AIR enabled devices and are not cross compatible with other nLight product lines at this time.

ORDERING INFORMATION

Example: RPODBA 2P DX WH G2				
Series	Poles & Scenes	Dimming Control	Color	Generation
RPODBA	[blank] Single Pole 2P Two Pole 2S 2 Scene control (2 buttons) 4S 4 Scene control (4 buttons)	[blank] On/Off Control DX On/Off + Raise/Lower Control	WH White IV Ivory AL Light Almond BK Black GY Gray RD Red	G2 Generation 2 Compatibility

ORDERING INFORMATION

All rPODBA switches are shipped with wall plates, however, the following order information is available to acquire replacement wall plates.

Wall Plate - Additional or Replacement						
Series	# of Gangs	Color			Packaging	
WS XPODA Wall Plates (Standard) SSW Sealed Covers	1 GNG Single Gang	WH White IV Ivory GY ² Gray	AL ² Light Almond BK ² Black RD Red	VP ² Variety Pack	[blank] Single Unit ³ M5 ² 5 Pack M6 ^{1,2} 6 Pack	

Accessories	
RPODBA MOUNTRING	Replacement mounting ring for rPODBA and rPODB switches
SSW 1GNG WH	Sealed screwless wall plate to prevent liquid intrusion, white
SSW 1GNG IV	Sealed screwless wall plate to prevent liquid intrusion, ivory
SSW 1GNG RD	Sealed screwless wall plate to prevent liquid intrusion, red

1. Available only for variety pack.
2. Not available for SSW series.
3. Single units only available for SSW series.

WALL SWITCH CLEANING

It will occasionally be necessary to clean the wall switches. All rPODBA switches may be wiped down with a soft cloth or paper towel dampened with glass cleaner, vinegar and water, hydrogen peroxide, or a mild abrasive. Spray a limited amount on the cloth or paper towel prior to applying. Do not spray cleaner on the switches directly, and do not wipe the switches down with a towel saturated (drips when wrung out) with cleaner.

If the ability to clean the switches using chemical spray disinfectants is desired, we recommend the use of the Sealed Screwless Wall Plate (SSW). The Sealed Screwless Wall Plate is a cover for the standard wall plate, designed with an IP54 rating. It consists of a transparent silicone rubber layer that covers the wall switch to prevent liquids from entering the wall switch while maintaining a tactile button feel. The Sealed Screwless Wall Plate is the ideal solution to prevent liquids from entering the wall switch while maintaining a tactile button feel. The Sealed Screwless Wall Plate is the ideal solution to help protect a wall switch from fluid entering the device while enabling the use of disinfectants recommended by the EPA for use against SARS-CoV-2, the coronavirus that causes COVID-19, which often require spraying or saturating the surface.

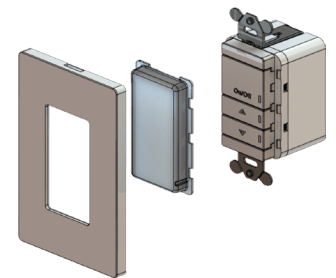

For more information on the [Sealed Screwless Wall Plates](#)

SPECIFICATIONS

Dimensions	2.74" H x 1.68" W x 1.63" D (6.96 cm x 4.27 cm x 4.14 cm)
Weight	4.25 oz
Mounting	Single Gang Switch Box or Low Voltage Ring
Color	White, Ivory, Lt. Almond, Gray, Red, Black
Operating Temperature	-40°C to 60°C (indoor use only)
Relative Humidity	Standard: 20 to 75% non-condensing
Radio Frequency	Dual Radio: 900Mhz & 2.4GHz
RF Transmit Power	900Mhz: +20dBm; 2.4GHz: Variable
Wireless Standard	900MHz: IEEE 802.15.4-based 2.4GHz: Version 4.0+ of the Bluetooth specification
Wireless Range	900MHz: Up to 1,000 ft. (~304m) in free space/ line of sight Minimum of 150 ft through typical construction 2.4GHz: Up to 60 ft. (~18m) in free space/ line of sight
Security	Application Data Encryption: AES-128 bit Mutual Entity Authentication Message Confidentiality Message Authentication and Replay Prevention Limited Anonymity Complies with California Civil Code Title 1.81.26, Security of Connected Devices, approved under Senate Bill No. 327 (2018)
Regulatory Compliance	FCC ID: 2ADCB-RMODIT3 RoHS IC: 6715C-RMODIT3 IFETEL: RCPNLL20-2057 UL 916 (E110912)
Battery Type	3 AAA lithium (included)
Battery Life	10 years (with lithium batteries)
Programming Tool	CLAIRITY™+ mobile app

DEFAULT LABELING

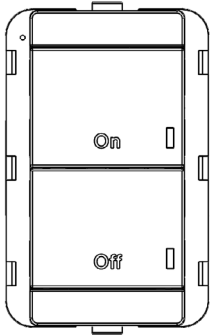

rPODBA

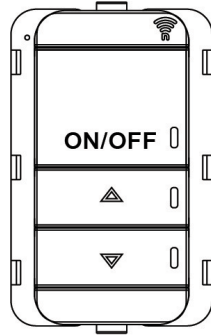

rPODBA DX

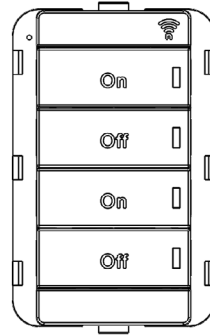

rPODBA 2P

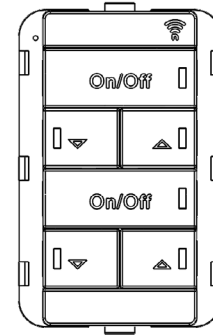

rPODBA 2P DX

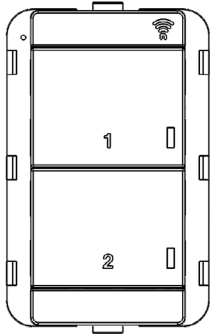

rPODBA 2S

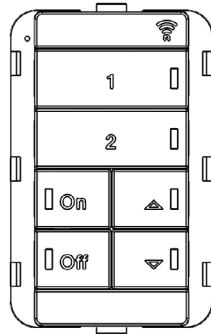

rPODBA 2S DX

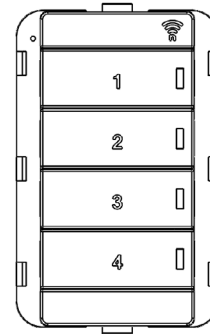

rPODBA 4S

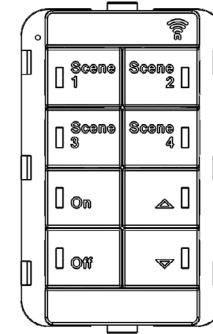

rPODBA 4S DX

INSTALLATION OVERVIEW

Installation of the rPODBA is simple, wire free, and does not require special tools. Follow the instructions below to install the rPODBA wall switch.

OUT-OF-THE-BOX DECORA WALL PLATE

- Remove the wall plate from the device by pulling the sides out to expand the wall plate and release it from the mounting flanges.
- Connect the unit to the gang box
 - The unit will connect to the gang box by screws, one at the top and one at the bottom
 - To ensure correct wall plate installation, drive the screws until the mounting flanges contact the wall surface. If the screws are overdriven, the mounting flanges will disengage, preventing wall plate installation. If this happens, reattach the mounting flange(s) and install to correct position. (The flanges may be reattached by inserting the two tabs in the side of the unit and pushing the part inward to engage the three snaps.)
- Reattach the wall plate
 - Expand the wall plate horizontally
 - Place the wall plate onto the unit
 - Contract the horizontally expanded wall plate onto the unit such that the side flange features seat inside the wall plate
- No wiring needed

OFF-THE-SHELF DECORA WALL PLATE

When installing the unit with standard off-the-shelf decora wall plates, the following steps should be followed.

- Remove the Acuity wall plate from the device by pulling the sides out to expand the wall plate and releasing it from the mounting flanges.

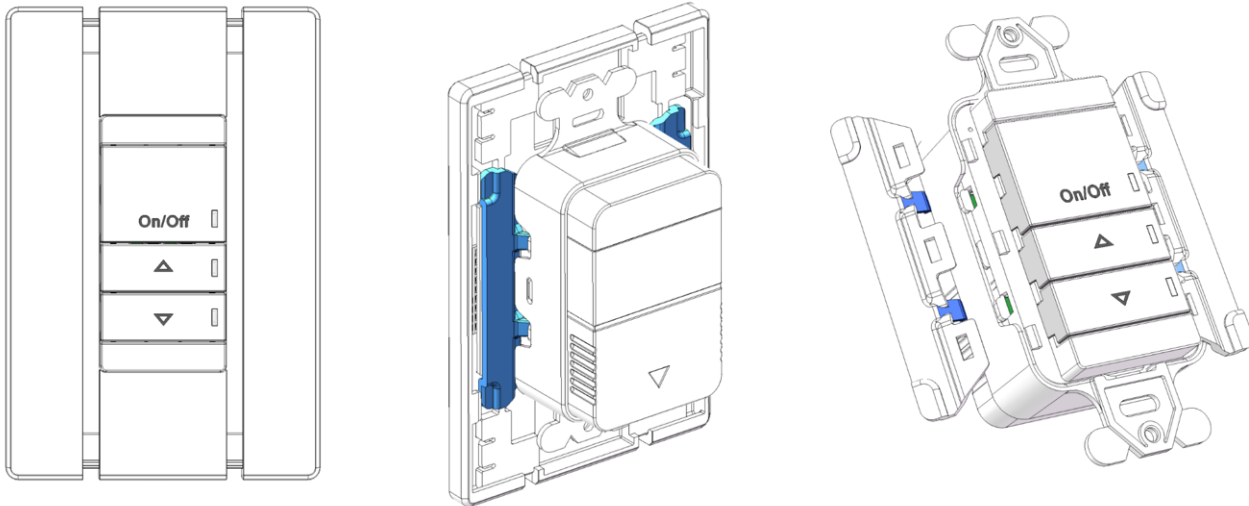

- Unhook and remove the side flanges from the device
- Connect the unit to the gang box
 - The unit will connect to the gang box by screws, one at the top and one at the bottom
- Attach the wall plate