

BUILT-IN THERMOSTAT INSTALLATION

WF-CFT1 SERIES

WARNING

Before installing and operating this product, the user and/or installer must read, understand and follow these instructions and keep them handy for future reference. If these instructions are not followed, the warranty will be considered null and void and the manufacturer deems no further responsibility for this product. The following instructions must be adhered to in order to avoid personal and serious injuries, property damages and potentially fatal electric shocks. Switch off the power at the circuit breaker/fuse before installing, repairing and cleaning the unit. Make sure the unit is appropriate for the intended use (if needed, refer to the product catalog or a representative).

1. Remove the grille of the unit.
2. Mount the thermostat to the thermostat mounting bracket. FIG. 1
3. Connect the black wire from the unit to one of the terminals of the thermostat. FIG. 2
4. Connect the black wire supplied in the kit to the other thermostat terminal. FIG. 3
5. Fix the thermostat bracket to the unit using the screws supplied. FIG. 4
6. Connect the unit according to wiring diagram below.
7. Reinstall the grille on the unit and insert the control button or the cap for a tempered proof solution. FIG. 5

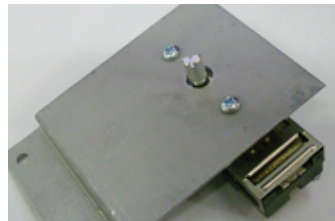

FIG. 1



FIG. 2



FIG. 3

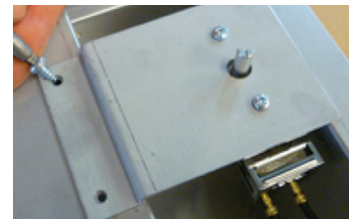
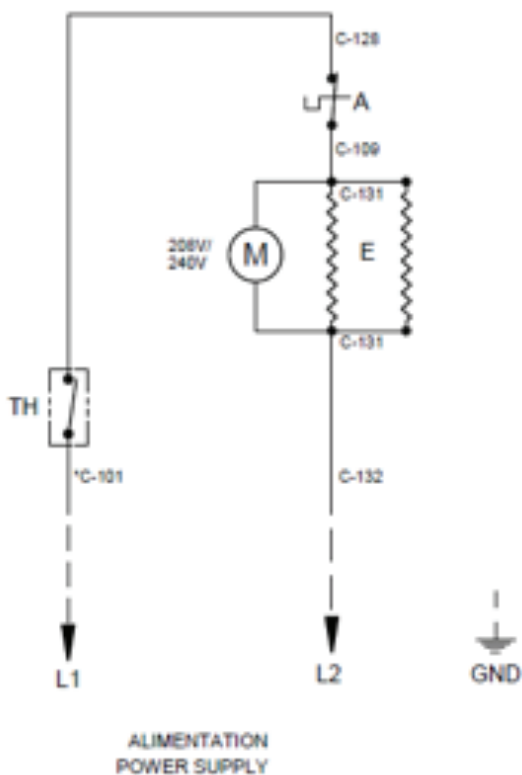

FIG. 4



FIG. 5



BUILT-IN THERMOSTAT INSTALLATION

WF-CFT2 SERIES

WARNING

Before installing and operating this product, the user and/or installer must read, understand and follow these instructions and keep them handy for future reference. If these instructions are not followed, the warranty will be considered null and void and the manufacturer deems no further responsibility for this product. The following instructions must be adhered to in order to avoid personal and serious injuries, property damages and potentially fatal electric shocks. Switch off the power at the circuit breaker/fuse before installing, repairing and cleaning the unit. Make sure the unit is appropriate for the intended use (if needed, refer to the product catalog or a representative).

1. Remove the grille of the unit.
2. Bend two of the thermostat terminals at a 90° angle. FIG. 1
3. Take the two red wires supplied and connect them to the bent terminals. FIG. 2
4. Connect the red wire from the unit to one of the red wires connected to the thermostat using the appropriate wire nut. FIG. 3
5. Connect the black wire of the unit to one unbent terminal of the thermostat. FIG. 4
6. Connect the black wire supplied in the kit to the other unbent terminal of the thermostat. FIG. 5
7. Fix the thermostat bracket on the unit using the screws supplied. FIG. 6
8. Connect the unit according to wiring diagram below.
9. Re-install the grille on the unit and insert the button.

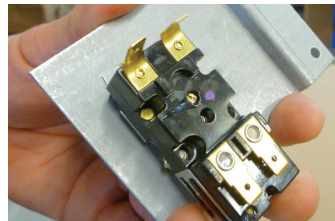

FIG. 1

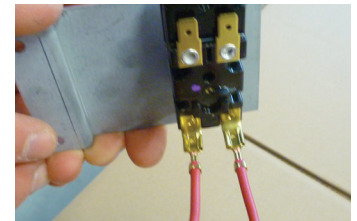

FIG. 2

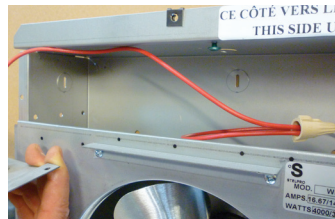

FIG. 3

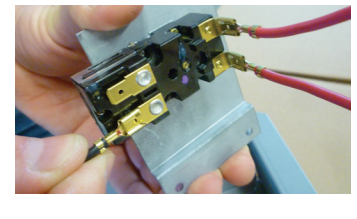

FIG. 4

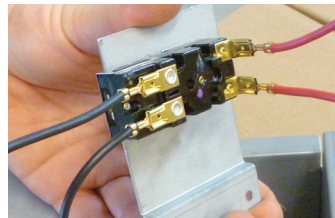

FIG. 5

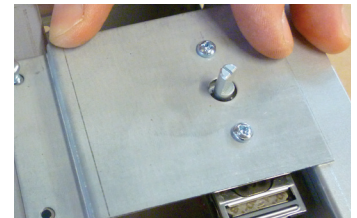
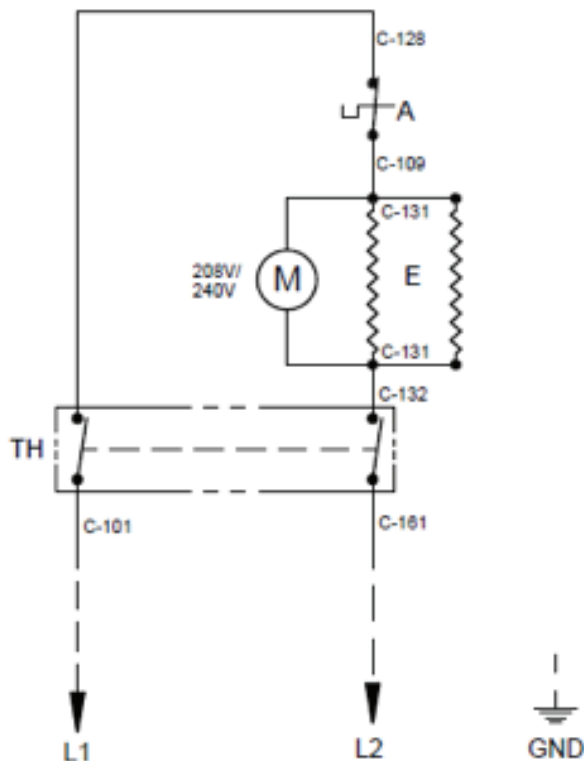

FIG. 6



ALIMENTATION
POWER SUPPLY