

# °STELPRO

OWNER'S MANUAL

**SSFR** SELF-REGULATING FREEZE PROTECTION  
REEL CABLE



INS-SSFR\_0622

THANK YOU FOR YOUR PURCHASE!  
NEED ASSISTANCE? CONTACT °STELPRO'S CUSTOMER SERVICE.

**WWW.STELPRO.COM**  
**1-844-STELPRO**

# IMPORTANT INSTRUCTIONS

SSFR series cables increase or decrease the heat output in a self-regulating way depending on the variation of the ambient temperature. A thermostat may not be necessary in some applications, and the cable will never overheat or burnout even when overlapped. The heating cable has a flame-retardant thermoplastic outer jacket that is resistant to water and inorganic chemicals and protects against abrasions and impacts. SSFR series cables are suitable for up to a maximally admissible workpiece temperature of 65°C (150°F).

This self-regulating parallel heating cable can be used for plastic or metal pipe freeze protection and flow maintenance of pipes, tanks and valves. It also can be used in roof and gutter de-icing applications. A UV-stabilized thermoplastic elastomer outer jacket covers the braid for use in wet applications and protects it from sun exposure.

**This product must be installed correctly to ensure proper operation and prevent shock or fire. Carefully follow all of the installation instructions and read these important warnings.**

1. To minimize the danger of fire from sustained electrical arcing if the heating cable is damaged or improperly installed, and to comply with the requirements of national electrical codes, ground-fault equipment protection must be used on each heating cable branch circuit. Arcing may not be stopped by conventional circuit protection.
2. Component approvals and performance are based on the use of specified parts only. Do not substitute parts or use vinyl electrical tape.
3. The black heating-cable core is conductive and can short. It must be properly insulated and kept dry.
4. The conductive layer of this heating device must be connected to a suitable grounded terminal.
5. The installer should apply the nameplate label to the surface of the junction box.
6. Keep kit components and heating cable ends dry before and during installation.
7. Damaged bus wires can overheat or short. Do not cut braid or bus wire strands when scoring the jacket or core.
8. Bus wires will short if they come into contact with each other. Keep bus wires separated.
9. Heat-damaged components can short. Use a heat gun or a torch with a soft, yellow, low-heat flame, not a blue focused flame. Keep the flame moving to avoid overheating, blistering or charring the heat-shrinkable tubes. Avoid heating other components. Replace any damaged parts.
10. Use only fire-resistant insulation materials such as fiberglass wrap.
11. Leave these installation instructions with the user for future reference.
12. The cable should not be twisted during installation.
13. De-energize all power circuits before installation or servicing.
14. The heating cable should not be embedded.

**WARNING: Improper installation, use, operation or maintenance of this product may result in injury or death from electric shock or fire. It may also result in property damage from ice dams. Make sure the chosen heating cable is suitable for your application.**

## SAVE THESE INSTRUCTIONS

# SELECTION AND DESIGN PIPE

## 1

### CABLE TYPE SELECTION

- Use **Table 1** to select heating cables for insulated metal pipes and **Table 2** to select heating cables for insulated plastic pipes.
- Read across the table to find your pipe size, then drop down to the line corresponding to the lowest air temperature for that application and the correct insulation thickness.

**TABLE 1 – METAL PIPES**

LOWEST AIR TEMPERATURE °C (°F)	INSULATION THICKNESS (IN.)	NOMINAL PIPE SIZE (IN.)											
		½	¾	1	1¼	1½	2	2½	3	4	6	8	
-18 (0)	½												
	1												
	1 ½												
-29 (-20)	½									1.1	1.8		
	1											1.1	
	1 ½												
	2												
-40 (-40)	½								1.2	1.8			
	1										1.1	1.8	
	1 ½												
	2												

**TABLE 2 – PLASTIC PIPE**

LOWEST AIR TEMPERATURE °C (°F)	INSULATION THICKNESS (IN.)	NOMINAL PIPE SIZE (IN.)											
		½	¾	1	1¼	1½	2	2½	3	4	6	8	
-18 (0)	½									1.2	1.8		
	1											1.2	
	1 ½												
-29 (-20)	½						1.1	1.2	1.8				
	1									1.4	1.8		
	1 ½										1.3	1.8	
	2												1.3
-40 (-40)	½				1.1	1.2	1.8	1.8					
	1								1.1	1.8			
	1 ½										1.8	1.8	

SSFR1W05 / SSFR2W05

SSFR1W08 / SSFR2W08

SSFR2W10

**USE THICKER INSULATION**

Based on a 4.4°C (40°F) maintenance temperature with a 10% safety factor

3. The cell at that intersection has a particular shading and may have a number. The shading indicates which heating cable to use (key to the shading appears below the tables). A number represents the spiraling ratio (feet of heating cable per foot of pipe). If no number appears in the cell, straight trace the pipe. If a number does appear in the cell, spiral trace the pipe. If your spiraling ratio is 2, the length of the cable must be twice as long as the pipe.

### EXAMPLE (METAL PIPE)

- Pipe size: 1 in.
- Lowest air temp.: -17.7°C (0°F)
- Insulation thickness: ½ in.

**Cable selection:** SSFR1W05 or SSFR2W05

## 2

### CALCULATING THE TOTAL CABLE LENGTH

- Pipe length × spiraling ratio
- + 4 ft × qty of gate/globe valves × valve length (ft) × spiraling ratio
  - + 2 ft × qty of ball/butterfly valves × valve length (ft) × spiraling ratio
  - + 2 ft × qty of flanges × pipe diameter (ft) × spiraling ratio
  - + 2 ft × qty of pipe supports × pipe diameter (ft) × spiraling ratio
  - + 1 ft for each power connection
  - + 2 ft for each splice connection
  - + 3 ft for each tee connection
  - + 0.5 ft for each end seal

---

**Total heating cable length (ft)**

### EXAMPLE (METAL PIPE)

- Pipe size: 1 in.
- Lowest air temp.: -17.7°C (0°F)
- Insulation thickness: ½ in.
- Pipe length: 50 ft
- Spiraling ratio: 1 (from *Table 1*)
- Globe valves: 2 (each 0.5 ft long)
- Pipe supports: 10 supports for 1 in. pipe
- Power connection: 1x
- Splice connection: 0
- End seals: 1x

### Length of heating cable required:

Pipe length × spiral ratio	50 ft × 1 =	<b>50 ft</b>
Globe valves	4 ft × 2 × 0.5 × 1 =	<b>4 ft</b>
Pipe supports	2 ft × 10 × 1/12 × 1 =	<b>1.6 ft</b>
Power connection	1 ft × 1 =	<b>1 ft</b>
Splice connection	0	<b>0 ft</b>
End seals	0.5 ft × 1 =	<b>0.5 ft</b>
<b>Total</b>		<b>57.1 ft</b>

## 3

### DETERMINE THE MAXIMUM HEATING CABLE CIRCUIT LENGTH ALLOWED

See *Table 3*. Ensure that your circuits do not exceed the maximum circuit length listed in table. If necessary, use additional shorter circuits.

TABLE 3 – MAXIMUM CIRCUIT LENGTH PER CIRCUIT BREAKER

POWER	AMBIENT TEMPERATURE AT START-UP		120 V				240 V				
	W/FT	°F	°C	15 A	20 A	30 A	40 A	15 A	20 A	30 A	40 A
				FT				FT			
5	50	10	10	230	270	270	270	460	540	540	540
	32	0	10	230	270	270	270	460	540	540	540
	14	-10	10	180	210	270	270	360	420	540	540
	0	-18	10	140	190	270	270	285	380	540	540
	-20	-29	10	125	165	250	270	250	330	500	540
	-40	-40	10	110	145	220	270	220	295	420	540
8	50	10	10	150	200	210	210	300	400	420	420
	32	0	10	150	200	210	210	300	400	420	420
	14	-10	10	140	150	205	210	280	300	410	420
	0	-18	10	100	130	200	210	200	265	400	420
	-20	-29	10	85	115	175	210	175	235	350	420
	-40	-40	10	80	105	155	210	155	210	315	420
10	50	10	10	120	160	180	180	240	315	360	360
	32	0	10	105	140	170	180	210	280	340	360
	14	-10	10	95	125	165	180	190	250	330	360
	0	-18	10	80	110	160	180	160	215	325	360
	-20	-29	10	70	95	140	180	145	190	285	360
	-40	-40	10	60	85	125	170	125	170	255	340

**Note:** Circuit breaker sizing is based on section 427 of the National Electrical Code. Maximum circuit lengths are based on start-up load. Steady-state amps per foot are dependent upon heating cable temperature.

# INSTALLATION PIPE

## ELECTRICAL CODES

Articles 427 of the National Electrical Code and Section 62 of CAN/CSA-C22.1, Canadian Electrical Code, govern the installation of Self-regulating freeze protection reel cables (SSFR series cables) for pipe freeze protection.

**IMPORTANT: For the warranty to be valid, you must comply with all requirements outlined in these guidelines. All design information provided here is based on a standard installation with heating cable fastened to an insulated pipe.**

## ELECTRICAL PROTECTION

### VOLTAGE RATING

#### 120 V

SSFR1W05  
SSFR1W08

#### 240 V

SSFR2W05  
SSFR2W08  
SSFR2W10

For the maximum heating cable circuit length allowed for a given circuit breaker rating, we also provide examples. Refer to *Table 3*. Determine your circuit length based on your lowest anticipated start-up temperature.

## GROUND FAULT PROTECTION

The National Electrical Code and Canadian Electrical Code require ground-fault equipment protection on each heating cable branch circuit. To reduce the risk of fire caused by damage or improper installation, circuit breakers, or their equivalents, with a 30-mA trip level should be used. Alternative designs providing comparable levels of ground-fault protection may also be acceptable.

**WARNING: Ensure only qualified persons service the installed systems.**

**WARNING: Continuous circuit operation is necessary for safe operation of the equipment or manufacturing process.**

## ACCESSORIES REQUIRED



**SSFR-ALUTAPE**  
Aluminum  
adhesive foil tape



**SSFR-FIBTAPE**  
Fiberglass  
adhesive tape

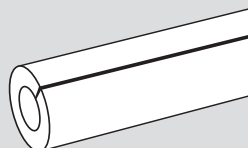

Insulation

NOTE: Accessories are sold separately.

## SPIRAL HEAT TRACING

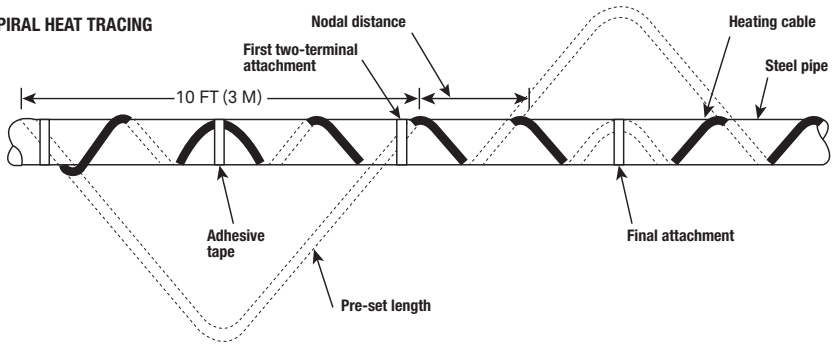

## 1

## PREPARE FOR INSTALLATION

1. Use a megohmmeter to test each reel of cable according to the instructions in the “Heating cable testing and maintenance” section.
2. Store the heating cable in a clean, dry place.
3. Complete pipe pressure test.
4. Review the heating cable design and compare to materials received to verify that the proper SSFR heating cable and accessories are available. The heating cable type is printed on the outer jacket of the cable.
5. Analyze the system and plan the routing of the SSFR heating cable on the pipe.
6. Verify that the heating cable is the correct factory fabricated unit or bulk cable type before installation (wattage output and voltage rating).
7. For field-assembled systems, verify that the components are designed, or recommended, for the specific heating cable used.
8. All welding, hydrostatic testing and painting of pipe should be completed before heating cable installation.
9. Inspect the piping system to ensure it is clean and has no sharp or jagged edges that might damage the heating cable.
10. Installation of the heat tracing before completion of the piping system is not recommended.

## 2

## CUT THE HEATING CABLE TO THE REQUIRED LENGTH

1. Cut the heating cable to the required length. This can be done before or after the cable is attached to the pipe.
2. Leave a minimum of 1 ft (30 cm) extra heating cable for connection to power. For splice and tee connections, leave a minimum of 1 ft (30 cm) for each section of heating cable. SSFR heating cable can be cut to the required length without affecting its heat output per foot.

### 3

## POSITION AND ATTACH HEATING CABLE TO PIPE

1. Make sure all pipe to be traced is dry.
2. Install heating cable using straight, spiraling or multiple tracing according to the “Heating cable selection and design” section.
3. For straight tracing, install the heating cable on the lower half of the pipe, e.g., in the 4 o'clock or 8 o'clock position.
4. Make sure to install the additional heating cable required for valves, flanges etc. as indicated in **Step 2** of the “Heating cable selection and design” section.
5. When the design needs spiraling, begin by suspending a loop every 10 ft (3 m) as shown in **Figure 1**. To determine the loop length, obtain the spiral factor from **Table 1 or 2** and multiply by 10. For instance, if a spiral factor of 1.3 is called for, leave a 13 ft (4 m) loop of heating cable at every 10 ft (3 m) section of pipe. Grasp the loop at its center and warp it around the pipe. Even out the distance between spirals by sliding the wraps along the pipe. Use SSFR-FIBTAPE Fiberglass adhesive tape to secure the center of loop to the pipe. Secure the heating cable flat to the pipe to ensure good contact.
6. Tape SSFR heating cable to the pipe at intervals of 2 ft (60 cm) using SSFR-FIBTAPE fiberglass adhesive tape. Do not use vinyl electrical tape, duct tape, metal bands or wire.
7. On plastic pipes, attach the full length of cable with SSFR-ALUTAPE aluminum adhesive foil tape.
8. Protect the heating cable ends from moisture or mechanical damage if they will be left exposed before connection.

### 4

## INSTALL HEATING CABLE END SEALS, SPLICES, TEES AND POWER CONNECTION

1. Install all end seals, splices and tees and the power connection prior to plugging in the cable.
2. If splicing or teeing, use only the SSFR10 splice and tee kit, SSFR-SPLICE splice kit or SSFR-TEE tee kit to satisfy National Electric Code and safety agency requirements.

### 5

## CHECK THE INSTALLATION

1. Prior to installing thermal insulation, make sure the heating cable is free of mechanical (form cuts, clamps, etc.) and thermal (soldering, overheating, etc.) damage.
2. Visually check all power connections, end seals, splices and tees.
3. Using a megohmmeter, test each circuit according to the instructions in the “Heating cable testing and maintenance” section both before and after installing the thermal insulation.



## 6

### INSTALL THERMAL INSULATION

1. A reliable system depends on properly installed and weatherproofed thermal insulation.
2. Ensure that the type and thickness of the insulation are in accordance with the heating cable selection information.
3. External surfaces of pipeline and vessel heating equipment that operate at temperature exceeding 60°C (140°F) must be physically guarded, isolated or thermally insulated to protect against contact by personnel in the area. Tables and all pipe work including valves, joints, wall penetrations and other elements have been fully insulated.
4. Minimize the potential for mechanical damage to the heating cable after installation by installing the insulation as soon as you have checked the cable installation.

## 7

### LABEL THE INSTALLATION

Place warning labels for pipe trace applications on the outer surface of the insulation at intervals of 10 ft (3 m) on alternating sides of pipe to indicate the presence of electric heating cable. Additional labels and application tape are contained in the SSFR03 kit.

## 8

### CHECK THE INSTALLATION

1. Prior to powering, check to be sure the heating cable is free of mechanical damage (cuts, clamps, etc.).
2. Visually check all power connections, end seals, splices, and tees for proper installation.
3. The field-wiring leads must have a current rating not less than the current rating of the heating tracing.
4. Using a megohmmeter, test each circuit according to the instructions in the “Heating cable testing and maintenance” section below.

# SELECTION AND DESIGN ROOFS, GUTTERS AND DOWNSPOUTS

## 1

### CALCULATE THE CABLE LENGTH REQUIRED

Roof edge length (ft) × feet of heating cable per foot of roof edge  
(see *Table 4*)

- + Roof extension (roof edge length (ft) x 0.5)
- + Roof valley (valley length (ft) x 2/3 x 2)
- + Distance around dormer (ft)
- + Total gutter length (ft)
- + Total downspout length (ft) + 1 ft
- + 1 ft for each power connection
- + 0,5 ft for each end seal
- + 2 ft for each splice connection
- + 3 ft for each tee connection

#### Total heating cable length (ft)

TABLE 4 – TYPICAL SPACING AND LAYOUT MEASUREMENTS REQUIRED ON METAL AND SHINGLE ROOFS

ROOF OVERHANG	LENGTH OF HEATING CABLE		CABLE LOOP HEIGHT	
	SHINGLE ROOF	METAL ROOF (24 IN. / 60 CM)	SHINGLE ROOF	METAL ROOF
None	1.9 ft / 58 cm	2.5 ft / 76 cm	18 in. / 46 cm	18 in. / 46 cm
12 in. / 30 cm	2.0 ft / 61 cm	2.5 ft / 76 cm	18 in. / 46 cm	24 in. / 60 cm
24 in. / 61 cm	2.7 ft / 82 cm	3.5 ft / 107 cm	30 in. / 76 cm	36 in. / 90 cm
36 in. / 91 cm	3.6 ft / 110 cm	4.5 ft / 137 cm	42 in. / 107 cm	48 in. / 122 cm
48 in. / 122 cm	4.5 ft / 137 cm	5.5 ft / 168 cm	54 in. / 137 cm	60 in. / 152 cm

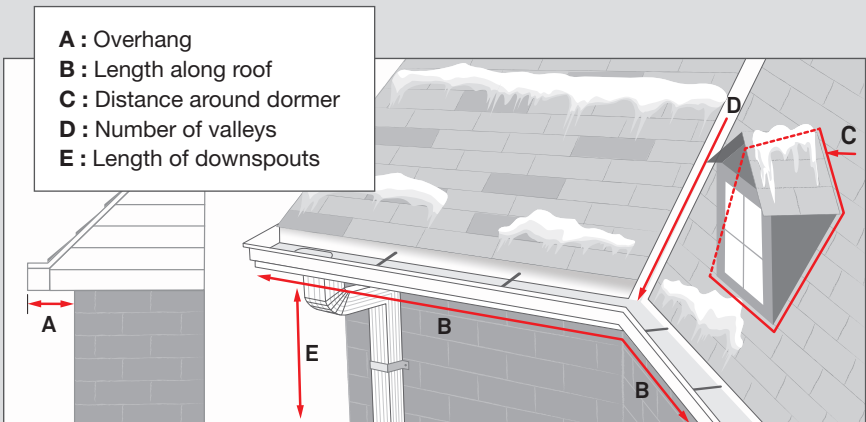

**NOTE:**

- The roof extension takes into account the length of cable needed to reach the cable laid in the gutter (from the roof edge).
- In-line splices and tee splices should be avoided where possible.
- Heating cable in downspouts should be looped (2 ft [61 cm] of heating cable per feet [30 cm] of downspout) and should extend below the frost line if tied into a drainage system.
- Field-assembled end terminations should not be located in an area where moisture is present. End terminations should not be located at the lowest point of downspouts.
- The circuit length for a given overcurrent protection device must not exceed the maximum length specified by the manufacturer.
- The maximum exposure temperature of all roof, gutter and downspout materials must be verified, and the heating cable selected must not exceed its temperature ratings.
- For roof drains leading into a heated area, a loop of heating cable is installed to a typical depth of 3 ft (1 m).

**EXAMPLE (SHINGLE ROOF):**

- Roof edge: 40 ft
- Roof extension: 20 ft
- Valley: 0
- Roof overhang: 1 ft
- Roof gutter: 40 ft
- Downspout: 15 ft
- Power connection: 1 ea.
- Tee connection: 0
- End seal: 1 ea.
- Voltage available: 240 V
- Heating cable: SSFR2W08

**Length of heating cable required:**

Roof edge	40 ft x 2 (see <i>Table 4</i> ) =	<b>80 ft</b>
Roof extension	40 ft x 0.5 =	<b>20 ft</b>
Roof gutter	40 ft	<b>40 ft</b>
Downspout	16 ft	<b>16 ft</b>
Power connection	1 ft x 1 ea.	<b>1 ft</b>
Tee connection	0	<b>0 ft</b>
End seal	0.5 ft x 1 ea =	<b>0.5 ft</b>
<b>Total</b>		<b>157.5 ft</b>

This total is less than the 188-ft maximum circuit length; therefore only one circuit is required.

**2**

**DETERMINE THE MAXIMUM HEATING CABLE CIRCUIT LENGTH ALLOWED**

See *Table 3 on page 5*. Ensure that your circuits do not exceed the maximum circuit length listed in the table. If necessary, use additional shorter circuits.

# INSTALLATION

## ROOFS, GUTTERS AND DOWNSPOUTS

SSFR series cables are suitable for use with SSFR00 and SSFR08 power connection kits for roof and gutter de-icing applications. SSFR heating cables are intended to be used in wet applications. Only SSFR heating cable sets (SSFR1W05, SSFR2W05, SSFR1W08 or SSFR2W08 heating cable and integral connections) are covered for the following applications/installations, snow melting equipment in Canada (Installation Type C in the U.S.A.) and roof and gutter de-icing in Canada (Installation Type B in the U.S.A.), when used with the following kits: SSFR00 (Power connection), SSFR08 (GFCI power connection), SSFR10 (Splice/tee connection), SSFR12 (End seal), SSFR13/14 (Roof clips) and SSFR15 (Hanger bracket).

### ELECTRICAL PROTECTION

#### VOLTAGE RATING

##### 120 V

SSFR1W05  
SSFR1W08

##### 240 V

SSFR2W05  
SSFR2W08

For the maximum heating cable circuit length permitted for a given circuit breaker rating, refer to **Table 5**. Limit your circuit length based on your lowest anticipated start-up temperature.

### GROUND FAULT PROTECTION

The National Electrical Code and Canadian Electrical Code require ground-fault equipment protection on each heating cable branch circuit. To reduce the risk of fire caused by damage or improper installation, circuit breakers, or their equivalents, with a 30-mA trip level should be used. Alternative designs providing comparable levels of ground-fault protection may also be acceptable.

**WARNING: Ensure only qualified persons service the installed systems.**

**WARNING: Continuous circuit operation is necessary for safe operation of the equipment or manufacturing process.**

# ACCESSORIES REQUIRED

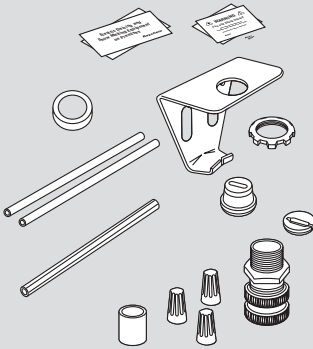

**SSFR00**  
Power connection kit

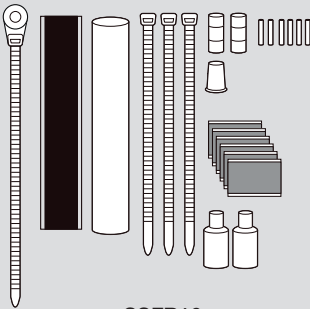

**SSFR10**  
Splice and tee Kit  
(if splicing or teeing)

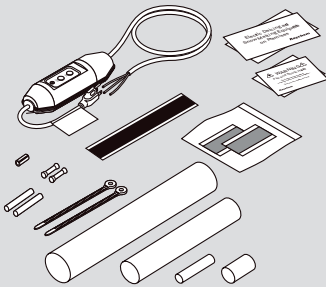

**SSFR08**  
Plug-in power connection kit  
(with end seal)

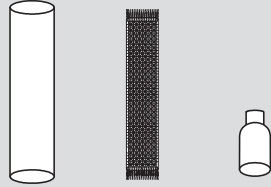

**SSFR12**  
End seal kit

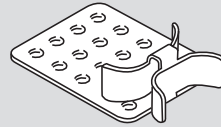

**SSFR13 (x10) | SSFR14 (x50)**  
Roof clips



**SSFR15**  
Downspout cable hanger bracket

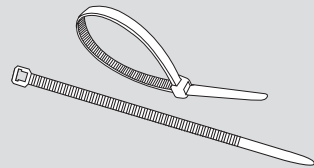

Ties\*

\*For shingle roof

NOTE: Accessories are sold separately.

## TOOLS REQUIRED

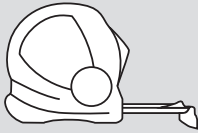

Tape measure

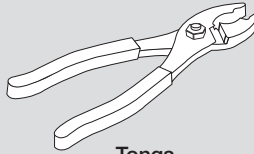

Tongs



Marking chalk

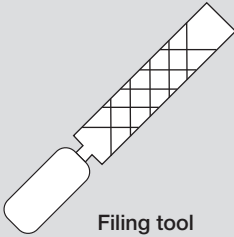

Filing tool

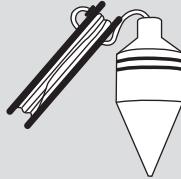

Weighted string\*

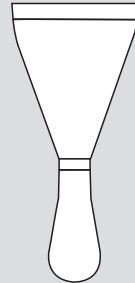

Putty knife

\*The string should be at least as long as the longest downspout.

# 1

## PREPARE FOR INSTALLATION

1. Secure the heating cable in accordance with the Article 426 of the NEC.
2. Store the heating cable in a clean, dry place.
3. Use only the following SSFR accessories to satisfy National Electric Code and safety agency requirements: see accessories required.
4. Carefully plan the routing of the heating cable for roof and gutter de-icing.
5. Make sure that gutters and downspouts are free of leaves and other debris.
6. The mounting surface must be inspected for sharp edges where the heating cable will be located (and removed as necessary).
7. A listed weatherproof power connection should be located and mounted in a sheltered area.

# 2

## CUT THE CABLE TO THE REQUIRED LENGTH

1. Cut the heating cable to the required length. This can be done before or after it is installed. Leave a minimum of 1 ft (30 cm) extra heating cable for electrical connections. For splice and tee connections, leave a minimum of 1 ft (30 cm) for each section of heating cable. SSFR heating cable can be cut to the required length without affecting its heat output per foot.
2. Protect the heating cable ends from moisture and mechanical damage if they will be left exposed before connection.

# 3

## POSITION AND ATTACH THE CABLE ON THE ROOF

1. Loop the heating cable on the overhang area of the roof. This is the part that extends past the building wall. Extend the bottom of each heating cable loop over the roof edge, and using a cable tie, connect the bottom of each loop to the cable running in the gutter to ensure a drainage channel off the roof into the gutters and downspouts. The cable running in the gutter should remain against the bottom of the gutter. Extend the top of each heating cable loop beyond where the wall joins the roof. We recommend a spacing of 2 ft (60 cm) between each clip along the roof edge. See the "Heating cable design" section (*Table 4*) for spacing and layout information.
2. Use SSFR13/SSFR14 roof clips to attach heating cable to the roof surface. One SSFR13 kit contains 10 double roof clips for approximately 7 linear ft (2.1 m) of roof edge. One SSFR14 kit contains 50 roof clips for approximately 35 linear ft (10.7 m) of roof edge.
3. For flat roofs, the heating cable can be spaced as needed to create runoff paths for melting ice and snow. Use single-ended clips located at intervals of 3 ft (0.9 m) to secure the cable to the roof. Roof clips may be attached to a shake or shingle roof with nails or screws, as shown in the *Figures 2 and 3*. Reseal the nail or screw holes if necessary before installing heating cable in the clips. Roof clips may be attached to a metal roof using screw, nail or adhesive.

SHINGLE ROOF

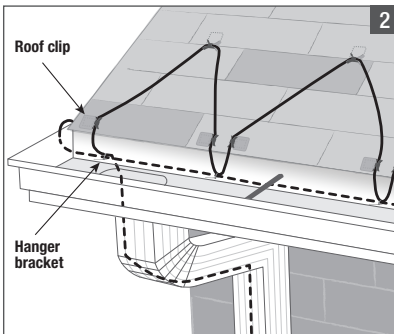

METAL ROOF

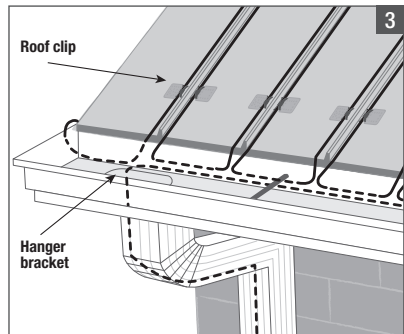

4. All penetration made on the surface of any style of roof should be moisture proofed by using a suitable sealant or sealing type fasteners. The installation of any heating system must not affect the overall integrity of the roof or gutter.
5. The mounting hardware must be made of corrosion resistant material and should not have sharp edges or burrs that could damage the heater cable.
6. Trace two-thirds the way up each valley with a double run of heating cable, as shown in the *Figure 4*.

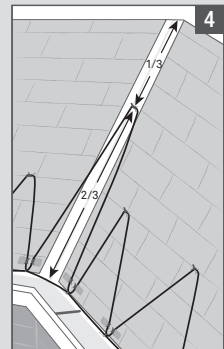

## 4

### POSITION AND ATTACH THE CABLE IN GUTTERS AND DOWNSPOUTS

1. Run heating cable along gutters and into downspouts, ending below the freezing level. Permanent attachment of the cable to the gutter bottom is not necessary. Loop the heating cable in downspouts if convenient, such as when the downspout is not at the end of the run, or use the SSFR10 splice and tee kit to tee down the downspout, as shown in the *Figure 5*.
2. Use SSFR15 downspout hangers to protect the heating cable from fraying and damage from sharp edges and to provide strain relief. Refer to SSFR15 kit instructions for installation details.
3. Use SSFR13/SSFR14 roof clips to route heating cable into and out of the gutters in such a way as to prevent abrasion to the cable. Protect all cable that protrudes past the lower opening of the downspout.

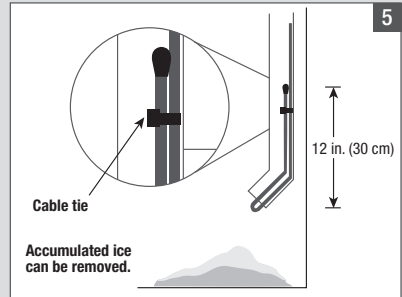

## 5

### INSTALL HEATING CABLE END SEALS, SPLICES, TEES AND POWER CONNECTION

1. Install all end seals, splices and tees and the power connection prior to plugging in.
2. Follow the SSFR00 or SSFR08 kit installation instructions.
3. Use only listed weatherproof junction boxes approved for wet locations when installing SSFR heating cables with the SSFR08 power connection kit for roof and gutter applications.
4. Use only listed watertight construction or Type 3, 3s, 4, 4X, 6, or 6P enclosure junction boxes when installing.
5. Use only listed weatherproof type wiring cable from the circuit breaker to the power connection box. The cable should be protected from damage by installing it in a rigid metal or nonmetallic raceway.
6. When possible, all power connection boxes should be located in a protected area (such as under eaves), and the entry should be at the bottom of the box. In all cases, a drip loop should be provided.

## 6

### LABEL THE INSTALLATION

Two copies of a caution notice indicating the presence of electric de-icing and snow-melting equipment on the premises are packed with the SSFR00 unit. One notice must be posted at the fuse or circuit-breaker panel and the other on or next to the on/off control for the cable unit. Both notices must be clearly visible.



# 7

## CHECK THE INSTALLATION

1. Prior to powering, check to be sure the heating cable is free of mechanical damage (cuts, clamps, etc.).
2. Visually check all power connections, end seals, splices and tees for proper installation.
3. Using a megohmmeter, test each circuit according to the instructions in the “Heating cable testing and maintenance” section below.
4. Junction boxes should be inspected for water or evidence of previous water ingress. If moisture is present, the box should be restored to a dry condition and the cause of ingress should be eliminated.
5. The functionality of overcurrent protection devices must be checked.

### NOTE:

- Do not cross or overlap cable heating sections.
- The cable must be installed 10 in. (25.4 cm) away from combustible surfaces such as wood.
- The minimum bending radius of each heating cable is 1.5 in. (38.1 mm).
- In all locations, route and secure cable to avoid possible mechanical damage, such as from ladders, etc.
- All actual lengths installed should be recorded. The installer should provide installation drawings and data.
- The minimum installation temperature for the heating cable is 0°F (-18°C).

## TESTING AND MAINTENANCE

We recommend that the insulation resistance between the bus wire and the heating cable grounding braid or metal pipe should be checked during installation using a 2500-VDC megohmmeter (500 VDC minimum). The minimum reading should be 20 megohms, regardless of length.

Record the original values for each circuit. Take additional readings during regularly scheduled maintenance and compare to the original value. If the readings fall below 20 megohms, inspect cables and insulation for signs of damage.

If physical damage is found, the entire damaged section must be removed and a new section of heating cable spliced in using only approved SSFR10 or SSFR-SPLICE splice kits. Do not repair the damaged heating cable section. If physical damage cannot be found, the complete circuit should be removed and replaced with new SSFR heating cable.

**WARNING: Shock and fire hazard. Damaged heating cable or components can cause electrical shock, arcing and fire. Do not attempt to energize damaged cable or components. Replace them immediately using a new length of heating cable and the appropriate SSFR accessories.**

# °STELPRO LIMITED WARRANTY

This limited warranty is offered by °STELPRO Design Inc. (“°STELPRO”) and applies to the following product made by °STELPRO: model **SSFR**. **Please read this limited warranty carefully.** Subject to the terms of this warranty, °STELPRO warrants its products and their components against defects in workmanship and/or materials for the following periods from the date of purchase: **2 years**. This warranty applies only to the original purchaser; it is non-transferable and cannot be extended.

## CLAIM PROCEDURE

If at any time during the warranty period the unit becomes defective, you must cut off the power supply at the main electrical panel and contact 1) your installer or distributor, 2) your service center or 3) °STELPRO’s customer service department. In all cases, you must have a **copy of the invoice** and provide the **information written on the product nameplate**. °STELPRO reserves the right to examine or to ask one of its representatives to examine the product itself or any part of it before honoring the warranty. °STELPRO reserves the right to replace the entire unit, refund its purchase price or repair a defective part. Please note that repairs made within the warranty period must be authorized in advance in writing by °STELPRO and carried out by persons authorized by °STELPRO.

Before returning a product to °STELPRO, you must have a °STELPRO authorization number (RMA). To obtain it, call the customer service department at: **1-844-STELPRO**. The authorization number must be clearly written on the parcel or it will be refused.

## CONDITIONS, EXCLUSIONS AND DISCLAIMER OF LIABILITY

This warranty is exclusive and in lieu of all other representations and warranties (except of title), expressed or implied, and °STELPRO expressly disclaims and excludes any implied warranty of merchantability or implied warranty of fitness for a particular purpose.

°STELPRO’s liability with respect to products is limited as provided above. °STELPRO shall not be subject to any other obligations or liabilities whatsoever, whether based on contract, tort or other theories of law, with respect to goods or services furnished by it, or any undertakings, acts or omissions relating thereto. Without limiting the generality of the foregoing, °STELPRO expressly disclaims any liability for property or personal injury damages, penalties, special or punitive damages, damages for lost profits, loss of use of equipment, cost of capital, cost of substitute products, facilities or services, shutdowns, slowdowns, or for other types of economic loss or for claims of a dealer’s customers or any third party for such damages. °STELPRO specifically disclaims all consequential, incidental and contingent damages whatsoever.

This warranty does not cover any damages or failures resulting from: 1) a faulty installation or improper storage; 2) an abusive or abnormal use, lack of maintenance, improper maintenance (other than that prescribed by °STELPRO) or a use other than that for which the unit was designed; 3) a natural disaster or an event out of °STELPRO’s control, including, but not limited to, hurricanes, tornadoes, earthquakes, terrorist attacks, wars, overvoltage, flooding, water damages, etc. This warranty does not cover any accidental or intentional losses or damages, nor does it cover damages caused by negligence of the user or owner of the product. Moreover, it does not cover the cost of disconnection, transport, and installation.

The warranty is limited to the repair or the replacement of the unit or the refund of its purchase price, **at the discretion of °STELPRO**. Any parts replaced or repaired within the warranty period with the written authorization of °STELPRO will be warranted for the remainder of the original warranty period. This warranty will be considered null and void and °STELPRO will have the right to refuse any claims if **products have been altered** without the written authorization of °STELPRO and if the nameplate numbers have been removed or modified. This warranty does not cover scratches, dents, corrosion or discoloration caused by excessive heat, chemical cleaning products and abrasive agents. It does not cover any damage that occurred during the shipping.

Some states and provinces do not allow the exclusion or limitation of incidental or consequential damages and some of them do not allow limitations on how long an implied warranty lasts, so these exclusions or limitations may not apply to you. This warranty gives you specific legal rights and you may have other rights which vary from state to state or from province to province.