

Catalog Number
Notes
Type

FEATURES & SPECIFICATIONS

INTENDED USE

Provides years of maintenance-free illumination for outdoor use in residential & commercial applications. Ideal for applications such as lighting walkways and stairways for safety and security.

CONSTRUCTION

Cast-aluminum housing with corrosion-resistant paint in either dark bronze or white finish.

ADA compliant.

OPTICS

4000K CCT LEDs.

Polycarbonate lens protects the LED from moisture, dirt and other contaminants.

LUMEN MAINTENANCE: The LED will deliver 70% of its initial lumens at 50,000 hour average LED life. See Lighting Facts label on page 2 for performance details.

ELECTRICAL

MVOLT driver operates on any line voltage from 120-277V

Operating temperature -30°C to 40°C.

1KV surge protection standard.

INSTALLATION

Surface mounts to universal junction box (provided by others).

LISTINGS

UL Listed to U.S. and Canadian safety standards for wet locations.

Tested in accordance with IESNA LM-79 and LM-80 standards.

WARRANTY — 5-year limited warranty. This is the only warranty provided and no other statements in this specification sheet create any warranty of any kind. All other express and implied warranties are disclaimed. Complete warranty terms located at:

www.acuitybrands.com/support/customer-support/terms-and-conditions

Note: Actual performance may differ as a result of end-user environment and application.

All values are design or typical values, measured under laboratory conditions at 25 °C.

Specifications subject to change without notice.

Outdoor General Purpose

OLLWD & OLLWU

LED WALL CYLINDER LIGHT



Specifications

All dimensions are inches (centimeters)

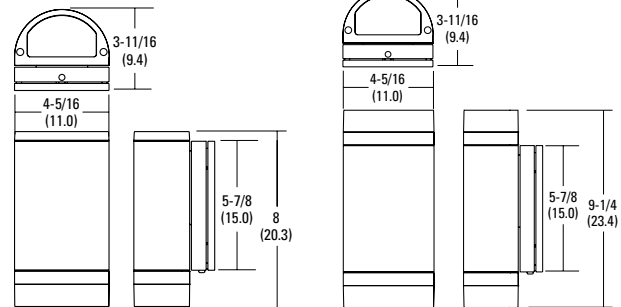

ORDERING INFORMATION

For shortest lead times, configure products using **bolded options**.

Example: OLLWD LED P1 40K MVOLT DDB

Series	Performance Package	Color temperature (CCT)	Voltage	Finish
OLLWD LED Downlight	P1	40K 4000K	MVOLT 120V-277V	DDB Dark bronze
OLLWU LED Up & downlight			120 120V ¹	WH White ²

Notes

1. Only available with OLLWU and in DDB.
2. Only available with OLLWU.

OLLWD & OLLWU LED Wall Cylinder Light

PHOTOMETRICS

To see complete photometric reports or download .ies files for this product, visit Lithonia Lighting's Outdoor LED homepage
 Tested in accordance with IESNA LM-79 and LM-80 standards.

OLLWD

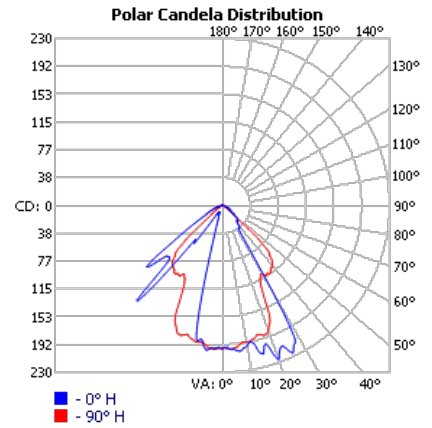
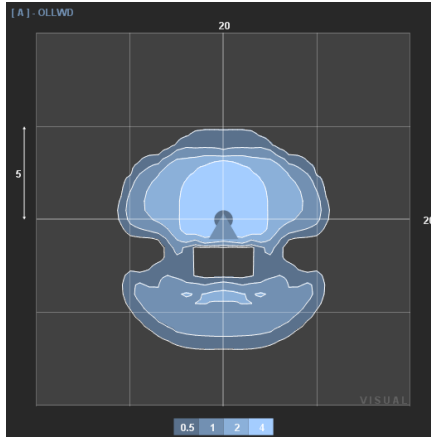
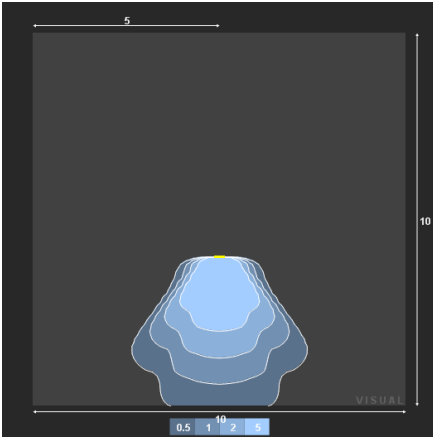

OLLWU

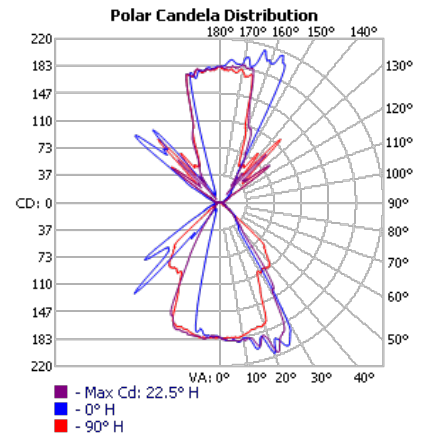
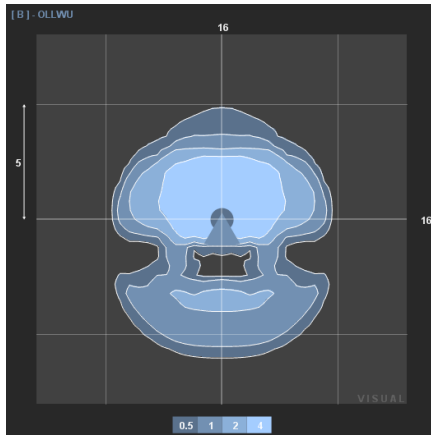
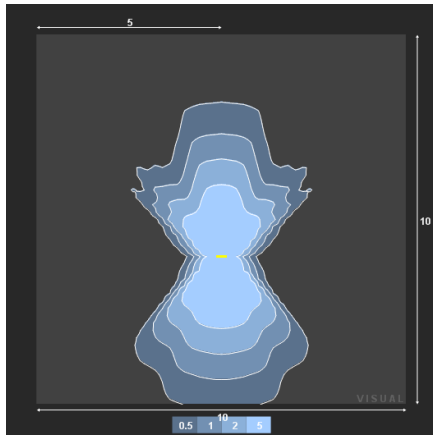

OLLWD

Lithonia Lighting

LED lighting facts®

A Program of the U.S. DOE

Light Output (Lumens)	533
Watts	9.1
Lumens per Watt (Efficacy)	58.63

Color Accuracy
 Color Rendering Index (CRI) **70**

Light Color
 Correlated Color Temperature (CCT) **4000 (Bright White)**

Warm White Bright White Daylight
 2700K 3000K 4500K 6500K

All results are according to IESNA LM-79-2008: Approved Method for the Electrical and Photometric Testing of Solid State Lighting. The U.S. Department of Energy (DOE) verifies product test data and results.

Visit www.lightingfacts.com for the Label Reference Guide.

Registration Number: NLSM-W8FYM (7/20/2016)
 Model Number: OLLWD LED P1 40K XXXXX XXX
 Type: Luminaire - Other

OLLWU

Lithonia Lighting

LED lighting facts®

A Program of the U.S. DOE

Light Output (Lumens)	947
Watts	14
Lumens per Watt (Efficacy)	67.64

Color Accuracy
 Color Rendering Index (CRI) **70**

Light Color
 Correlated Color Temperature (CCT) **4000 (Bright White)**

Warm White Bright White Daylight
 2700K 3000K 4500K 6500K

All results are according to IESNA LM-79-2008: Approved Method for the Electrical and Photometric Testing of Solid State Lighting. The U.S. Department of Energy (DOE) verifies product test data and results.

Visit www.lightingfacts.com for the Label Reference Guide.

Registration Number: NLSM-Y7HW88 (7/20/2016)
 Model Number: OLLWU LED P1 40K XXXXX XXX
 Type: Luminaire - Other