



# Outdoor Lighting

Specification Solutions Guide



# D-Series LED

## Area Luminaires

The D-Series family has been a favorite of industry professionals for use on exterior lighting projects. Now, the fully redesigned D-Series, is once again changing the game and bringing area lighting to a new level of excellence and performance. With 15 state-of-the-art optics to choose from, lighting designers have all the tools they need to effectively illuminate even the most challenging sites.



### D-Series Features:

- Three sizes deliver 5,000 to 60,000 lumens providing excellent scale for any project
- Leading-edge optical performance with the choice of 15 distribution patterns offering superior uniformity, wider pole spacings and unmatched corner and backlight control
- Embedded nLight™ AIR; other control options available
- Universal mounting built-in for easy installation onto existing mounting holes
- Refined and contemporary design that blends seamlessly into any environment



### Backlight Control

The state-of-the-art BLC optics reduce light behind poles while providing excellent forward and lateral projection. Poles can be strategically placed near adjacent property or boundary lines while achieving optimal curb line results.

- As little as 0.5% of total light behind pole
- Shortest distance to zero foot-candles achieved (less than 1/3 mounting height)

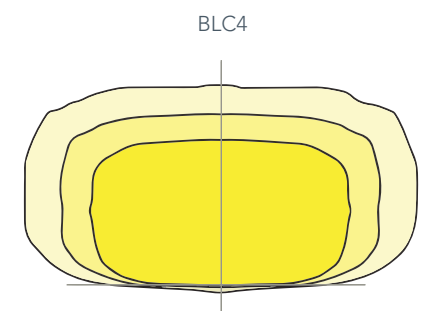



# Radean™ Family

## Pedestrian Luminaires

The RADEAN family brings unmatched style, visual comfort and affordability to pedestrian-scale lighting. Urban pedestrian spaces demand lighting solutions that look great during the day and create a visually comfortable environment at night. RADEAN's recessed low-brightness waveguide lens and patented transition zone work in concert to minimize high-angle light and reduce contrast ratios. The result is visually comfortable lighting that can't be matched.

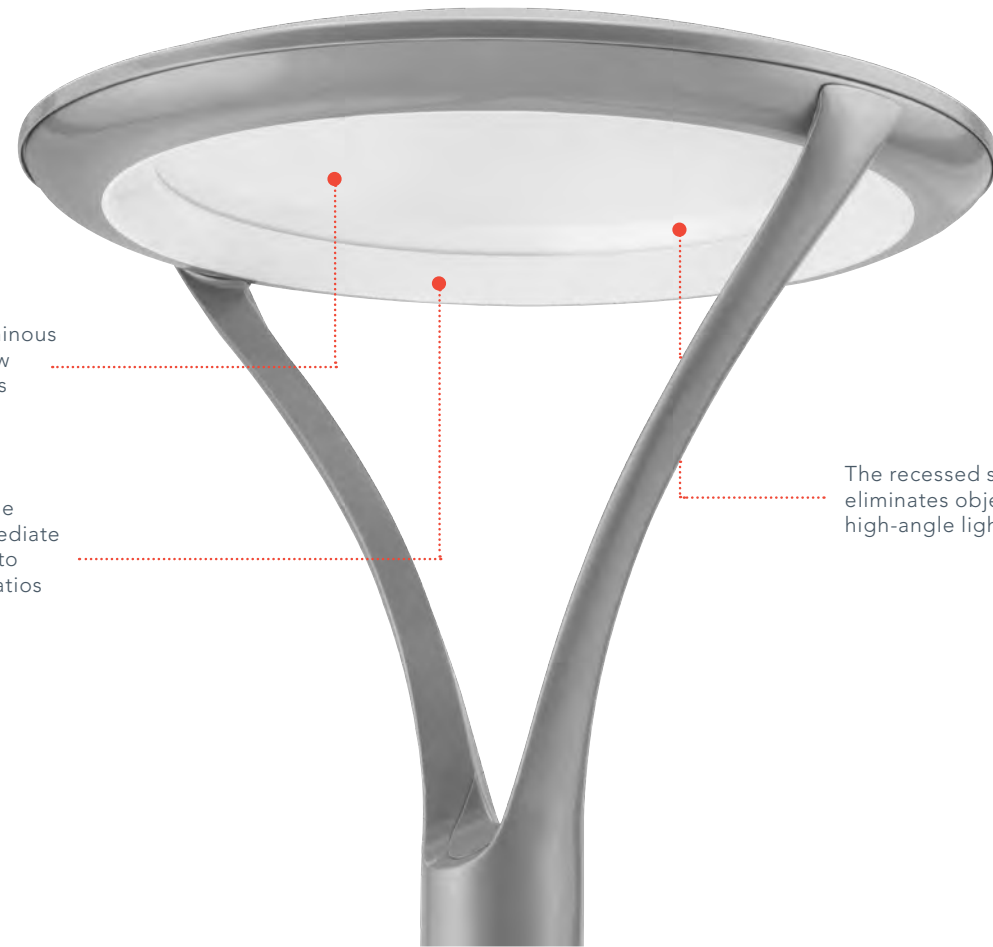

The uniformly luminous waveguide has low surface brightness

The transition zone creates an intermediate luminous surface to reduce contrast ratios

The recessed source eliminates objectionable high-angle light

With up to 16,000 lumens, the post-top and arm-mount luminaires can provide all the light you need at mounting heights of up to 20 feet. The complementary RADEAN bollards complete the family providing additional options for walkways.



## Bollard Configurations

Creating the ultimate in design freedom, the RADEAN Bollard allows opportunities for personalization. Of course, you can customize the height, from 40", 36", 30" to even 24", enabling uniform heights even over uneven terrain. The customization goes far beyond that with a choice of either the standard top or a slim top, and a choice of either the standard or deep crown.

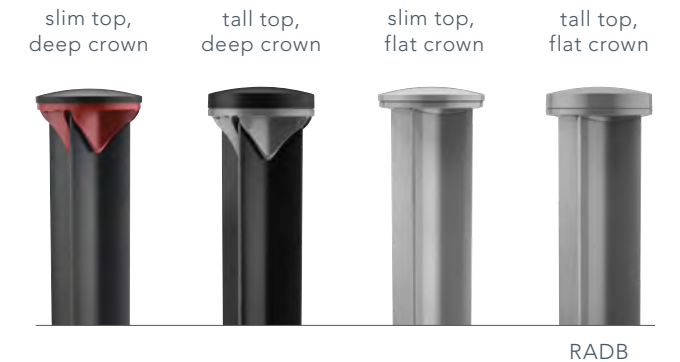

RADB



# WDGE LED

## Wall-Mount Luminaires

The WDGE family of LED wall-mounted luminaires will change the way you think about building-mounted lighting. It starts with dispelling the notion that wall-mounted luminaires need to match the pole-mounted luminaires, and that what works in the parking lot works on the side of the building.

In truth, there are two building-mounted lighting applications...entry-way lighting at lower mounting heights that require inviting visually comfortable illumination and area lighting, at higher mounting heights, augmenting the pole-mounted lighting.

The WDGE family of LED wall-mounted luminaires addresses the needs of both applications with four sizes, two technologies and one common, widely accepted form.



The WDGE family has all the attributes and options a specifier needs to create a lighting design that provides the illumination solutions of the site while meeting code requirements for egress lighting and controls. And since the WDGE is a Lithonia Lighting® product, you have confidence that your project will remain on budget and on time.

**Visually comfortable optics** create an inviting visual environment at the entryways of the building. Patented reflector technology combined with a recessed diffuse lens produce low surface brightness yet provide good optical control.

**Precision optics provide** the desired wide spacing and forward-throw at higher mounting heights. The combination of acrylic refractive lenses and high-power LEDs result in excellent uniformity and low power density.

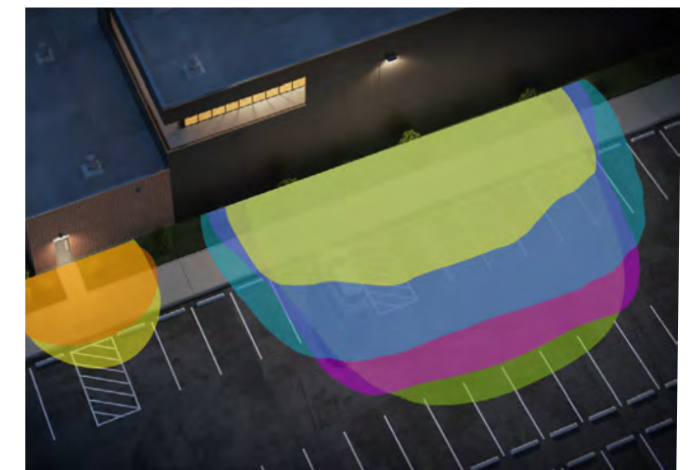



# ARC LED

Wall-Mount Luminaires

The ARC LED wall-mounted luminaires provide a visually comfortable and architectural design with the exceptional value. While not as full-featured as the WDGE family, the ARC LED wall-mounted luminaires have a similar non-pixelated light source that creates welcoming illumination. Self-contained emergency egress battery back-up options makes code compliance easy, without the need for an additional back-box.

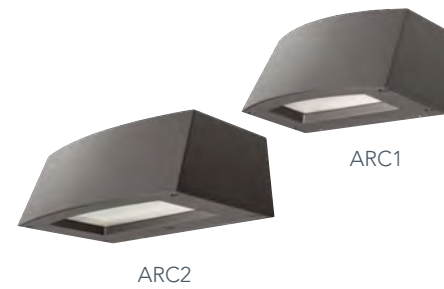

Two sizes make the ARC LED ideal for both over-the-door and perimeter lighting applications.

### ARC LED Features:

- Two sizes deliver 1,500 to 6,500 lumens
- Recessed diffused glass lens reduces brightness and minimizes high-angle light that causes glare
- Wide distribution and only 12% of light on the wall
- 80 CRI standard
- 0°C and -20°C integral emergency battery backup options
- Built-in wet location wiring compartment for applications with no existing junction box

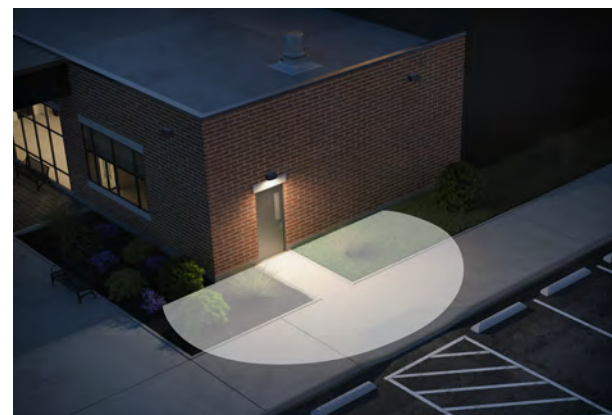
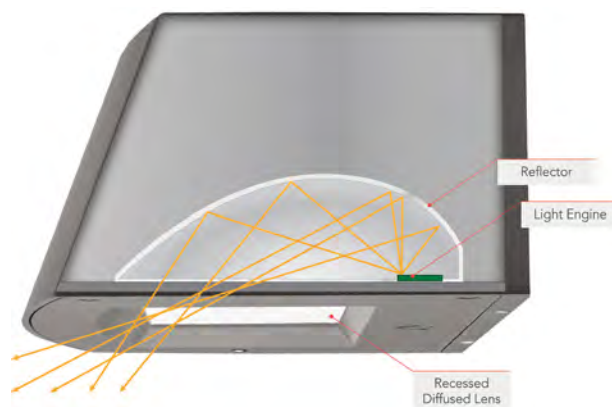

# WPX LED

Wall-Mount Luminaires

The WPX LED wall-mounted luminaires provide the best value in wall-mounted lighting. The simple geometric shape and lack of unattractive fins make the WPX luminaires attractive on any building. Four sizes of the WPX family deliver 850 to 9,200 lumens, making it a site-wide solution, from over-the-door lighting to mounting height up to 20 feet. A wide illumination pattern allows for a continuous safe and secure environment around the building's exterior.



### WPX LED Features:

- Four sizes deliver 850 to 9,200 lumens
- Simple geometric shape blends into any architecture
- Wide light distribution
- 3000K, 4000K and 5000K; 70 CRI and 80 CRI
- 0°C and -20°C integral emergency battery backup options WPX1 and WPX2



Superior illumination with wide, uniform distribution with LED array for minimal glare (no high intensity chip-on board LEDs that cause discomfort glare).



Geometric shape covers the footprint of a typical HID wall pack covering any unsightly stains.



Effortless installation with integral wiring compartment for easy mounting and wiring.

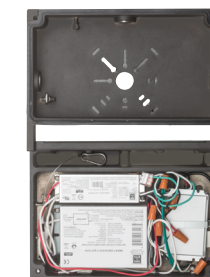

Self-contained emergency battery backup solution available on WPX1 and WPX2.



WPX0 - Easily configure CCT, lumen output and photocell options from one convenient control module during installation.



# D-Series LED

## Floodlight Luminaires

The D-Series LED floodlights have the lumen packages, photometric distributions and mounting options that specifiers demand. Three sizes of D-Series LED floods deliver 2,000 to 27,000 lumens. Using reflector optics the beam is shaped to allow seven different distributions with beam angles from 18° (NSP) to 85° (WFL) without the striations that can occur with refractive optics. Available with yoke, knuckle and integral slip-fitter mounting options as well as specialty options such as visors, wire guards and vandal guards, the D-Series is designed to be the specifier's go-to floodlighting solution.



### D-Series Floodlight Features:

- Three sizes deliver 2,000 to 27,000 lumens
- Seven floodlighting distributions
- Reflector optics for uniform illumination
- Multiple mounting options
- Visor, wire guard and vandal guard options

### Floodlight Applications

The D-series LED floodlights offer site-wide configurable options to meet the specifier's floodlighting needs for any application. Available with seven precision optics, three mountings and three color temperatures, D-Series LED floodlights offer vast design capabilities while delivering significant energy savings and long life.

- |                            |                          |                          |
|----------------------------|--------------------------|--------------------------|
| <b>1</b> Sign Lighting     | <b>3</b> Column Lighting | <b>5</b> Accent Lighting |
| <b>2</b> Flagpole Lighting | <b>4</b> Facade Lighting | <b>6</b> Area Lighting   |

# HLF LED

## Floodlight Luminaires

The Lithonia Lighting® HLF high lumen floodlights combine maximum lumens, highly engineered photometric distributions and robust mountings to create a versatile solution for floodlighting applications that require high mounting heights or high levels of illumination. With up to 100,000 lumens the HLF2 can replace two 1000W metal halide luminaires. Six different optical distributions get the light where it is needed, with the narrower distributions using innovative hybrid silicone optics.



### HLF LED Features:

- Choice of six optical distributions
- Two sizes deliver 25,000 to 100,000 lumens
- Super-efficient – up to 154 LPW
- Glass lens reduces dirt accumulation
- Yoke and integral slipfitter mounting
- IP66 construction



HLF makes floodlighting design easy with its six unique distributions, including full range aiming from 0° to 185° and is ideal for the most demanding applications such as up-lighting monuments, buildings and other structures.

### Photometric Distributions

HLF LED floodlights have a wide offering of photometric distributions that provide superior illumination and flexibility to meet the most demanding needs in application.

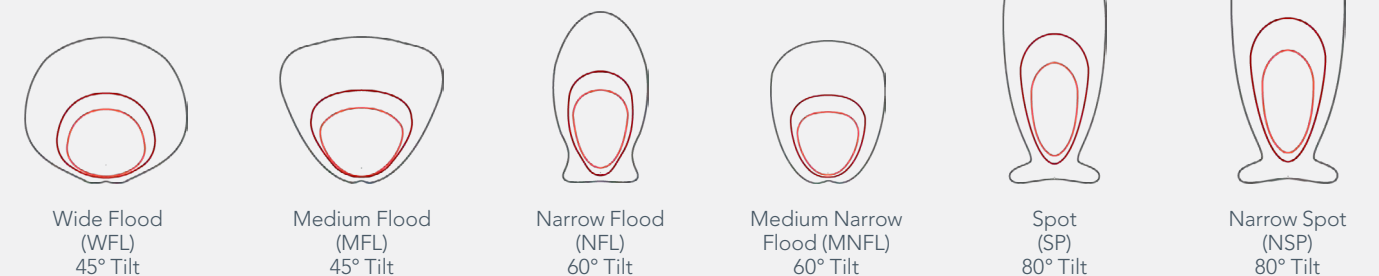



# RSX LED

## Area Luminaires

The RSX family of LED area luminaires is designed to replace the huge installed base of HID fixtures with a product that provides quality illumination along with the high energy savings and low initial cost that renovation projects demand. Four sizes deliver from 7,000 to 70,000 lumens while eight optical distributions allow customers to experience both energy savings and an enhanced end-user experience. A wide selection of mounting options makes the RSX family ready to take on any renovation project.



### RSX LED Features:

- Choice of ten optical distributions
- Choice of eight mounting options
- Integral universal mounting bracket mounts onto most any existing mounting holes for easy installation
- Efficacies of up to 150 lumens per watt
- Available with nLight® AIR wireless controls for energy savings and code compliance
- Industry-leading delivery

### Photometric Distributions

The RSX LED area luminaires have a wide offering of area photometric distributions to provide superior illumination in a variety of applications. Options include a specialized rotated "automotive front row" optic, that will make the merchandise pop in auto-dealership applications.



# RSXF LED

## Floodlight Luminaires

Optimized for pole-top floodlighting, the RSXF family of LED floodlights delivers both quality and quantity of illumination these applications demand. The RSXF LED floods are highly configurable offering up to 85,000 lumens, seven different floodlighting distributions with beams ranging from narrow spot to wide flood. A special Area Wide Forward (AWFD) optic is specifically designed for perimeter lighting applications, allowing for maximum spacing and forward throw while maintaining uniformity.



### Mounting Configurations

RSXF LED floodlights are available with the industry's best adjustable slipfitter and a variety of other mounting options. Compatible with 2 3/8" O.D. tenons, this robust slipfitter makes installation quick and easy with a spacious integral wiring compartment. Aiming can be adjusted in 5-degree increments and hex socket set screws provide a secure and attractive means of attachment to the tenon.

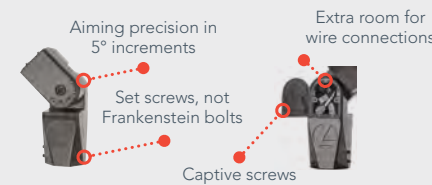

### Mountings Designed for the Contractor



### RSXF LED Features:

- Industry's best pole-top floodlighting solution
- Four sizes deliver 7,000 to 85,000 lumens
- Six optical distributions with beam angles from 19 to 160
- Unique Area Wide Forward distribution for perimeter floodlighting applications
- Innovative mountings make installation and aiming easy

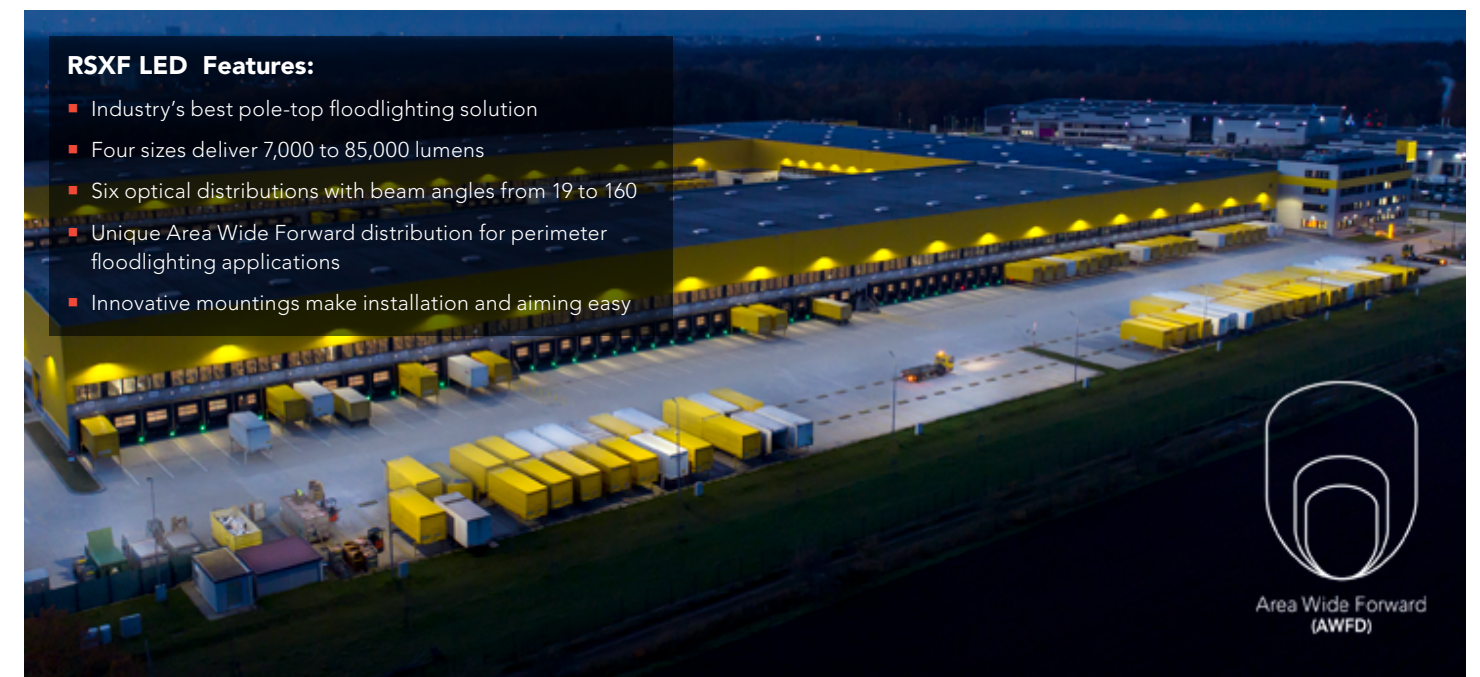



# VCPG/VCPGX

Parking Garage Luminaires

The VCPG is the Lithonia Lighting® visually comfortable parking garage lighting solution. The low mounting heights of parking garage applications require wide distributions while limiting high-angle light.



VCPGX

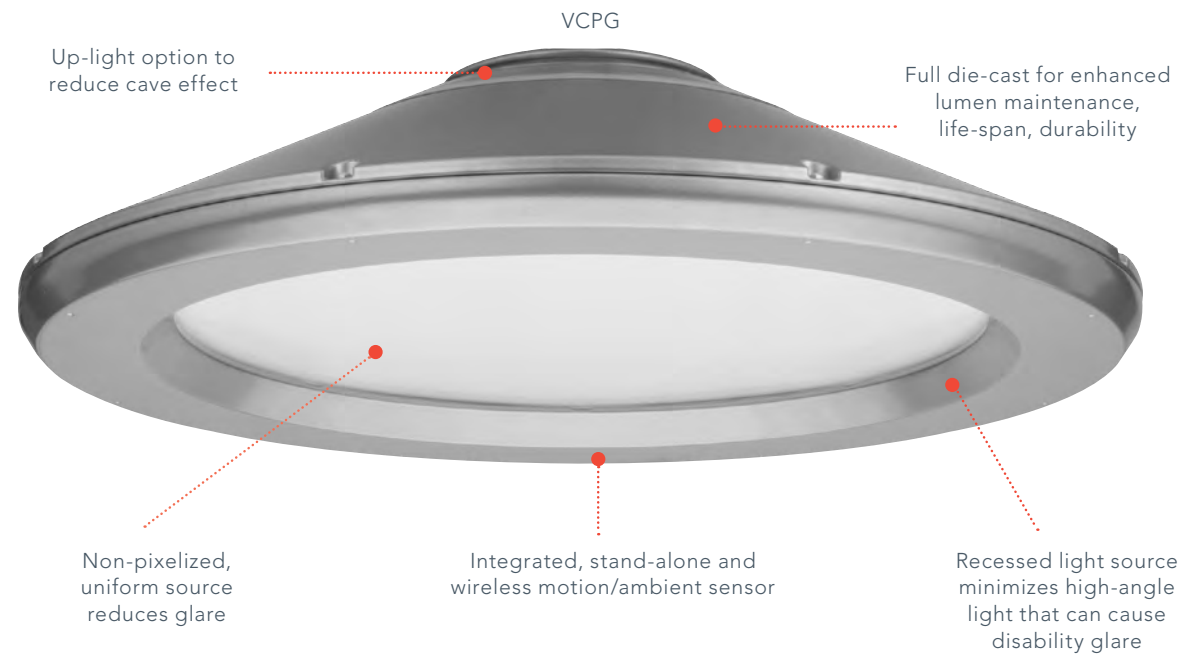

- Up-light option to reduce cave effect
- Full die-cast for enhanced lumen maintenance, life-span, durability
- Non-pixelized, uniform source reduces glare
- Integrated, stand-alone and wireless motion/ambient sensor
- Recessed light source minimizes high-angle light that can cause disability glare



The VCPGX has a deeply recessed waveguide that reduces high-angle light while creating a transition zone that reduces contrast further enhancing visual comfort.

### VCPG & VCPGX Features:

- Low-brightness waveguide light source creates a safe and visually comfortable environment for both pedestrians and drivers
- Optics provide a wide light distribution and greater uniformity
- Up to 16,000 lumens allows for one luminaire to be used at various mounting heights throughout the site
- Integrated emergency egress battery back-up options



The VCPG meets these requirements by using a low-brightness wave-guide lens and unique optics that get the light to where it is needed, providing excellent uniformity.

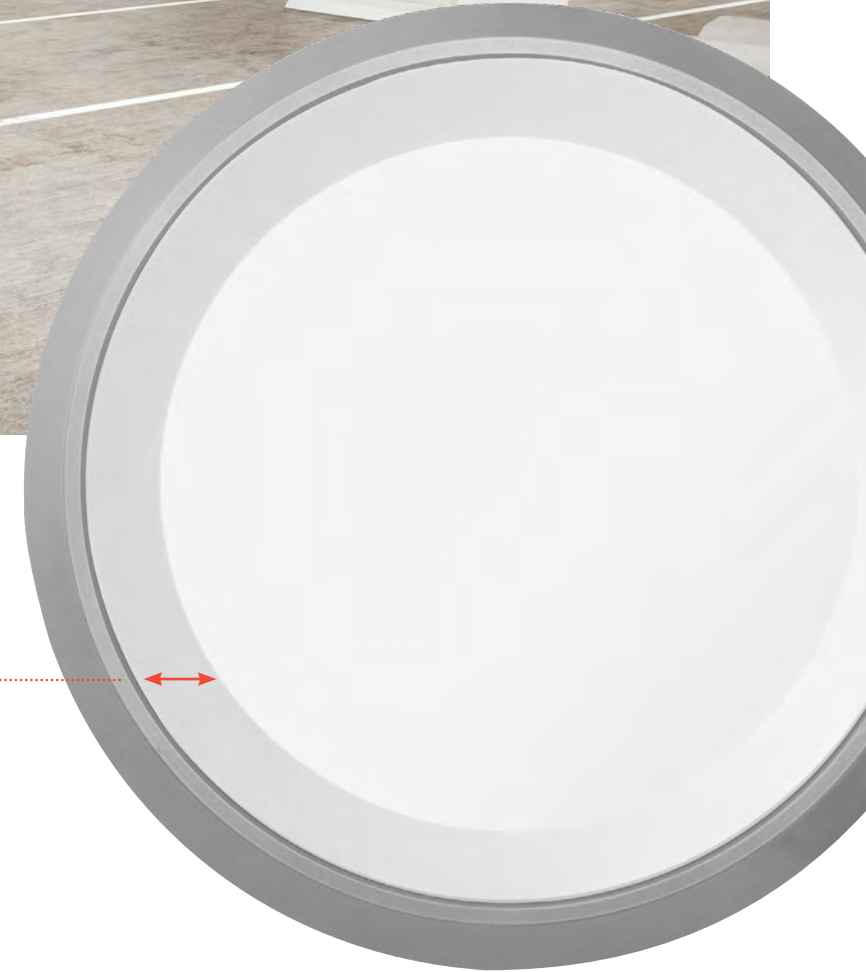





## nLight® AIR Wireless Lighting Control

nLight is a networked controls system that employs both wired and wireless technologies to connect office, warehousing, manufacturing, parking garage and parking lot lighting on a single platform. The combination of Lithonia Lighting® outdoor luminaires and nLight® AIR wireless controls creates a site-wide solution that saves energy and aids in meeting the requirements of increasingly stringent energy codes. The low occupancy of most outdoor lighting spaces creates a substantial opportunity. Simply dimming the luminaires to 30% during periods of non-occupancy can easily save 50% in energy in most applications. Lithonia Lighting's wide offering of high efficacy luminaires equipped with embedded nLight AIR controls are ideal solutions for aiding in meeting IECC and California Title 24 requirements for low power density, daylight switching and dimming during periods of non-occupancy.



### Key Features:

- Embedded nLight® AIR controls do not require field assembly or additional wiring
- Out-of-the-box motion sensing and dusk-to-dawn photocontrol functionality
- From-the-ground smart phone commissioning with the CIAIRity™ Pro app allows the luminaires to be wirelessly grouped such that all the luminaires in a group return to full power with a single detection event
- Luminaire output can be trimmed to meet the needs of the end-users and neighboring sites
- The addition of an nLight ECLYPSE™ with the AIR adapter creates a site-wide solution and additional functionality such as scheduled dimming with motion sensor over-ride

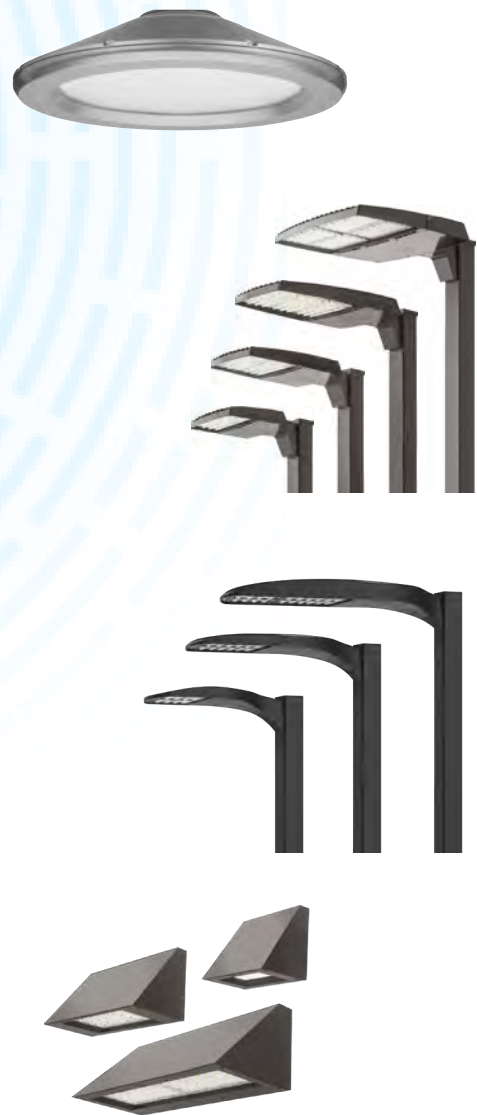

Join the conversation - follow us on social media.