

Individual Spec Sheet

COMETO CHOICE

SLIM BACKLIT COMMERCIAL DOWNLIGHT

6" 5 CCT and 3 Power Selectable

ORDERING INFORMATION

Order code: 69570
Model number: DLC06R-PS18Q-5CWH/CHOICE
UPC: 069549027794
Case quantity: 12

PHYSICAL DATA

Size in. (cm): Ø7 1/2 (Ø19)
Shape: Round
Finish: White
Lens material: Frosted Polycarbonate
Mounting: Recessed

PERFORMANCE DATA

Watts (W): 12/15/18
Volts (V AC): 120-347
Color temperature (K)¹: 2 700/3 000/3 500/4 000/5 000
Lumen output (lm)²: 1 200/1 500/1 800
Efficacy (lm/W): 100
CRI: 80+
Life L70 (h)³: 50 000
Beam angle (°): 100
Environment: Wet location
THD (%): <20
Power factor: >0.9
Cable Rating: FT6
Operating temp. range: -30°C to 40°C (-22°F to 104°F)
Dimming: 0-10 V

¹ Typical color temperature range: +/- 5 %.

² Lumen values are derived from photometric testing. Initial lumens range: +/- 10 %.

³ Life hours are derived from IESNA LM80-08 testing report and projected per IESNA TM-21-11 extrapolations.

COMPATIBLE ACCESSORIES (order separately)

Order code	Model number	Type	Inner diameter (in)	Outer diameter (in)	Case qty (master)
66822 ^{1,2}	ACC/MPLATE/6.25IN/HANG.BARS/STD	Mounting plate with hanger bars	6 1/4	-	25
64921	RF/ACC/6/MOUNT.PLATE/ADJ/STD	Adjustable mounting plate	6 1/4	-	24
64263	ACC/MPLATE/6.25IN/SQR/STD	Square mounting plate	6 5/16	-	96
66144	ACC/6/VAPOR BARRIER/STD	Vapor barrier extender	6 1/4	-	50
68615	GOOF RING-6.75IN	Goof ring	6 3/4	9 1/4	24

¹ Includes brackets and screws.

² Junction box not included.

This lighting equipment complies with Canadian standard ICES-005 for use in residential applications. Data is based upon tests performed in a controlled environment. Actual performance can vary depending on operating conditions. Specifications are subject to change without notice.

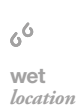

LUMEN SPECIFICATION TABLE

Order code	Model number	Watts (W)	2 700 K		3 000 K		3 500 K		4 000K		5 000 K	
			Lumen output (lm)	Efficacy (lm/W)	Lumen output (lm)	Efficacy (lm/W)	Lumen output (lm)	Efficacy (lm/W)	Lumen output (lm)	Efficacy (lm/W)	Lumen output (lm)	Efficacy (lm/W)
69570	DLC06R-PS18Q-5CWH/CHOICE	12	1 327	111	1 363	114	1 399	117	1 421	118	1 472	123
		15	1 634	109	1 678	112	1 721	115	1 749	117	1 801	120
		18	1 826	101	1 883	105	1 931	107	1 980	110	2 046	114

DEFAULT PROGRAMMING

18 W / 3 000 K

COMPATIBLE DIMMERS¹

Brand	Model
Legrand	RH4FBL3PTC, WS4FBL3P
Leviton	AWSMT-7DW ² , DD 710 ² , DS 710 ²
Lutron	DIVA DVSCTV, NOVA NTSTV DV

¹ Dimming range : 5%-100%

² Dimming range : 10%-100%

¹ This table shows dimmers that have been tested and have demonstrated proper operation under normal conditions. Each installation being unique, various factors such as load, common neutrals or other electrical products on the circuit can, in certain instances, cause variance in system performance. Read and comply to the dimmer installation instructions. Consult dimming system manufacturer for additional support in operation. Some dimmers may require more than one product for stable operation. Stanpro recommends to use dimmers designed to work with LED products. Older dimmers designed for incandescent products may cause erratic operation.

DIMENSIONS AND WEIGHTS

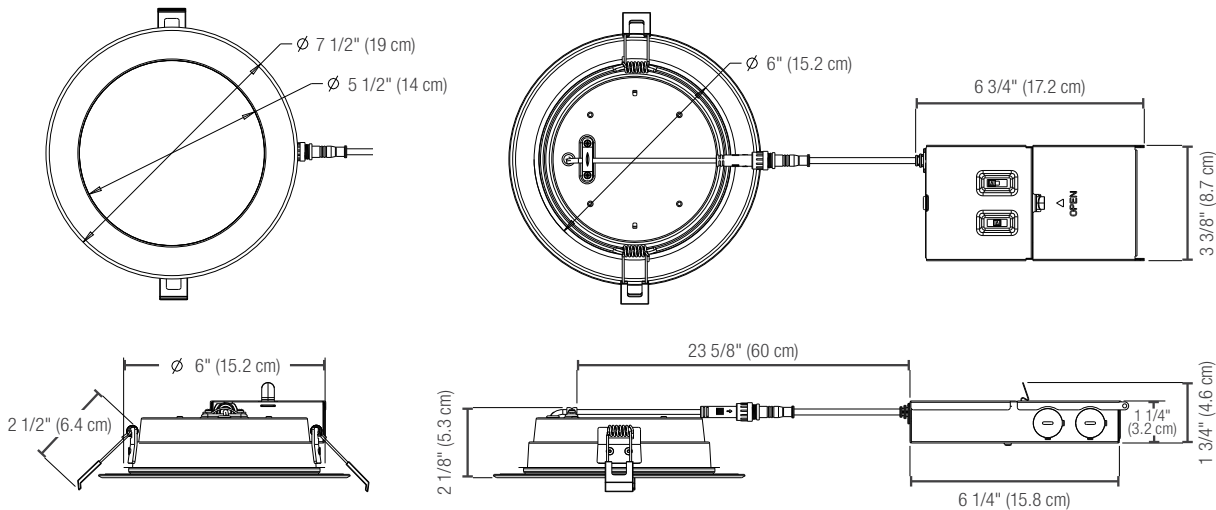

Net weight (lbs)	1.54
------------------	------

Data is based upon tests performed in a controlled environment. Actual performance can vary depending on operating conditions. All products are subject to change or may be discontinued any time without notice.

PHOTOMETRIC DATA¹

69570 • DLC06R-PS18Q-5CWH/CHOICE • 12 W • 3 000 K • 1 363.3 lm

Polar candela distribution

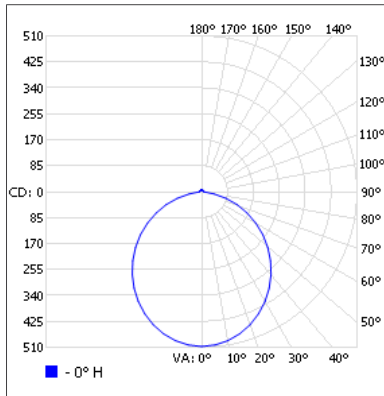

Zonal lumen summary

Zone	Lumens	% Fixture
0-30	376.8	27.6
0-40	612.1	44.9
0-60	1 065.8	78.2
60-90	261.9	19.2
70-100	110.4	8.1
90-120	18.0	1.3
0-90	1 327.7	97.4
90-180	35.6	2.6
0-180	1 363.3	100

Illuminance at a distance

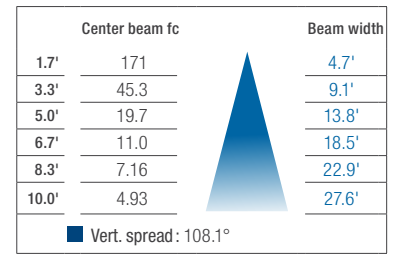

69570 • DLC06R-PS18Q-5CWH/CHOICE • 15 W • 3 000 K • 1 678.0 lm

Polar candela distribution

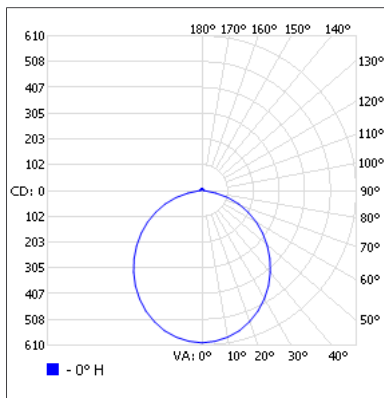

Zonal lumen summary

Zone	Lumens	% Fixture
0-30	458.5	27.3
0-40	744.8	44.4
0-60	1 298.7	77.4
60-90	337.6	20.1
70-100	146.9	8.8
90-120	19.6	1.2
0-90	1 636.3	97.5
90-180	41.7	2.5
0-180	1 678	100

Illuminance at a distance

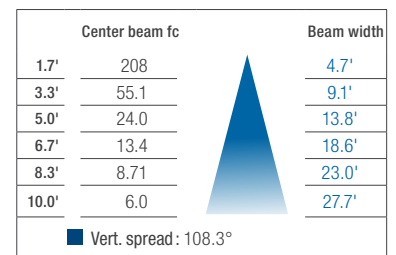

69570 • DLC06R-PS18Q-5CWH/CHOICE • 18 W • 3 000 K • 1 883.0 lm

Polar candela distribution

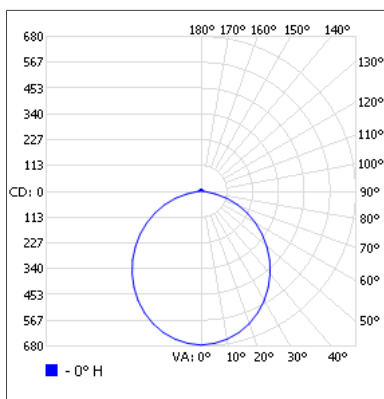

Zonal lumen summary

Zone	Lumens	% Fixture
0-30	515.0	27.3
0-40	836.4	44.4
0-60	1 456.3	77.3
60-90	378.7	20.1
70-100	169.7	9
90-120	23.6	1.3
0-90	1 834.9	97.4
90-180	48.1	2.6
0-180	1 883.0	100

Illuminance at a distance

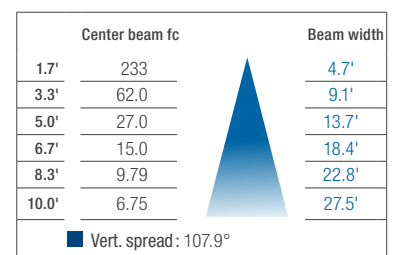

¹ Complete IES files available on our website.

Data is based upon tests performed in a controlled environment. Actual performance can vary depending on operating conditions. All products are subject to change or may be discontinued any time without notice.