

Industrial Relay Type RPY 3 10A Monostable



- High switching power
- Wide range of applications
- 10A switching capacity
- 3 pole configuration
- Flanged pins 5mm (0.20")
- DC coils from 6 to 220V
- AC coils from 6 to 380V
- Compliant with CE low voltage directive
- TÜV, UL, CSA approved

Product Description

The RPY relay can be used for a wide range of industrial applications. Available in a 1, 2, 3, 4 pole change-over contact configuration. Its wide terminals allow reliability and big currents.

Ordering Key

RPY A 003 A24 DLT

Type _____
 Terminal type _____
 Contact code _____
 Coil code _____
 Options _____

Terminal type: A= Plug in terminals, blades
 B= PCB terminals

Box content: 10 relays
 Box size: (W 240 x D 105 x H 38) mm Weight: 750g
 (W 9.45 x D 4.13 x H 1.50) inches Weight: 26.45oz

Approvals



Type Selection

Contact configuration	Contact rating	Contact code
3 change over contact (DPDT- 3 form C)	10A	003

Coil Characteristics, DC @ +25°C (+77°F), coil power 1.4W

Coil Code	Nominal Voltage VDC	Pick-up Voltage VDC	Drop-out Voltage VDC	Max.Allowed Voltage VDC	Coil Current mA	Coil Resistance Ω
6	6	4.5	0.60	6.6	240	25
9	9	6.75	0.90	9.9	161	56
12	12	9	1.20	13.2	120	100
24	24	18	2.40	26.4	60	400
36	36	27	3.60	39.6	40	900
48	48	36	4.80	52.8	30	1600
110	110	82.5	11.0	121	13	8400
220	220	165	22.0	242	6.67	33000

Coil Characteristics, AC @ +25°C (77°F), coil power 2VA

Coil Code	Nominal Voltage VAC	Pick-up Voltage VAC	Drop-out Voltage VAC	Max.Allowed Voltage VAC	Coil Current mA		Coil Resistance Ω
					50Hz	60Hz	
A6	6	4.8	1.8	6.6	330	280	6.5
A12	12	9.6	3.6	13.2	167	142	25.5
A24	24	19.2	7.2	26.4	83	70	102
A36	36	28.8	10.8	39.6	55	47	230
A48	48	38.4	14.4	52.8	42	36	410
A110	100/110	88	33.0	121	18	15	2300
A120	120	96	36.0	142	17	14.5	2700
A220	220	176	66.0	242	9	7.7	8600
A240	240	192	72.0	264	8.3	7	10000
A380	380	304	114	418	5.2	4.4	27500

Options

Nil = Standard (Fig.1)
D = Free Wheeling diode (DC coil only)
F = Flange Mount (Fig.2)
G = Gold Plated contacts

L = LED
T = Test Button

Note:
In case of more options use the alphabetical order for coding.
LED and test button are not available on flange mount version

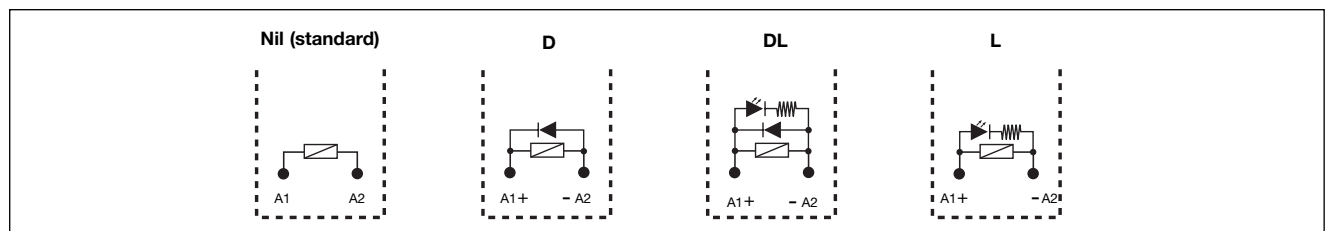

Contact Characteristics

Contact Rating (With resistive load)	10A - 250VAC	Max Switching Power	2500VA / 280W
Usually rating	10A-250VAC / 28VDC	Life	
Material	AgSnO₂In₂O₃	Electrical life	1x10⁵ cycles (3600ops/h)
Contact Resistance	≤50mΩ	Mechanical	1x10⁷ cycles (18000 ops/h)
Current		UL/CSA ratings	
Max. switching current	10A	1/3Hp 120VAC	
Min. switching current	10mA @ 12VDC	1/2Hp 240VAC	
Min. switching current G version	1mA @ 6VDC	10A @ 30VDC	
		10A @ 250VAC	

Insulation

Test voltage (1min.)		Insulation According to EN61810-5	
Between coil and contacts	2000VAC	Rated insulation voltage	250V
Between open contacts	1200VAC	Impulsive insulation	2kV
Contact / contact	1200VAC	Overvoltage categor	II
Insulation resistance	≥1000MΩ - 500V		

General Data

Nominal coil power	1.4W DC – 1.2VA AC	Vibration resistance	10 to 55Hz 1mm (0.04")
Operating time (at nominal voltage)	≤20ms	Shock resistance	Functional
Release time (at nominal voltage)	≤20ms	Termination	98m/s ² (10G)
Ambient temperature	-25° to +55°C (-13° to +131°F)	Construction	Flanges (blades) 5mm (0.20")
Ambient humidity	35% to 85%	Weight	Dust cover
			50g (1.76oz)

Pin View mm/inches

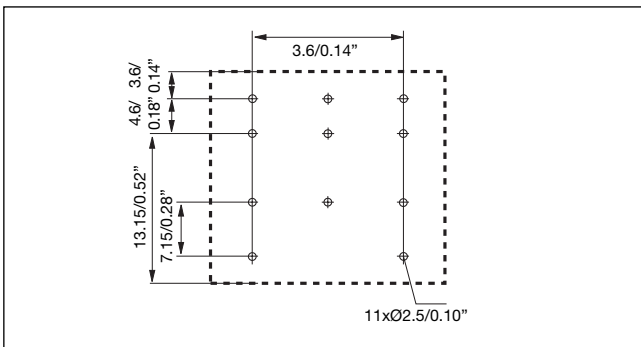

Wiring Diagram

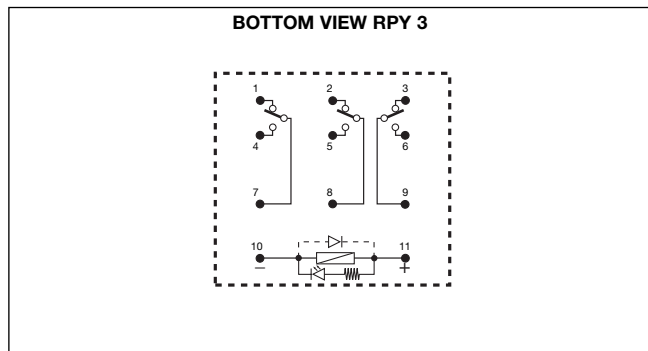

Dimensions mm/inches

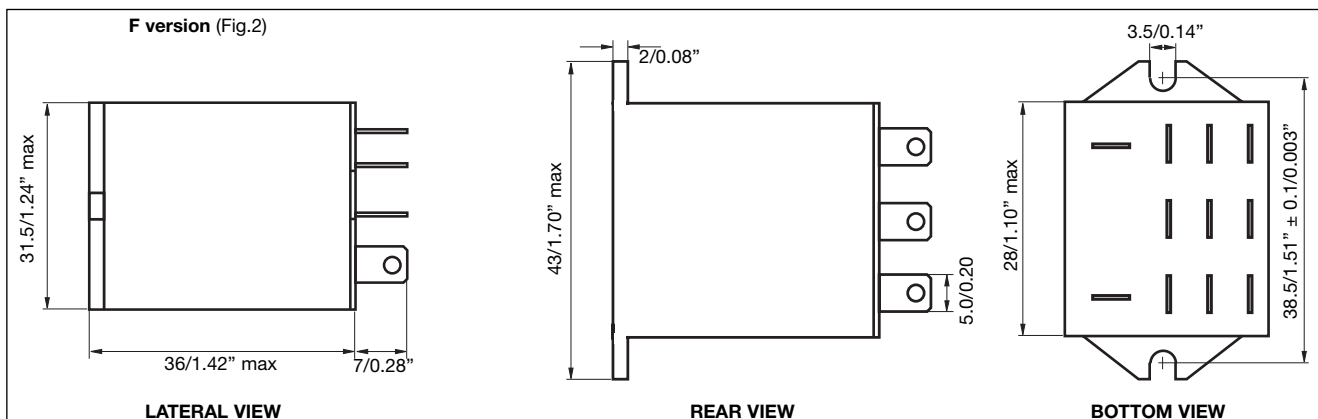
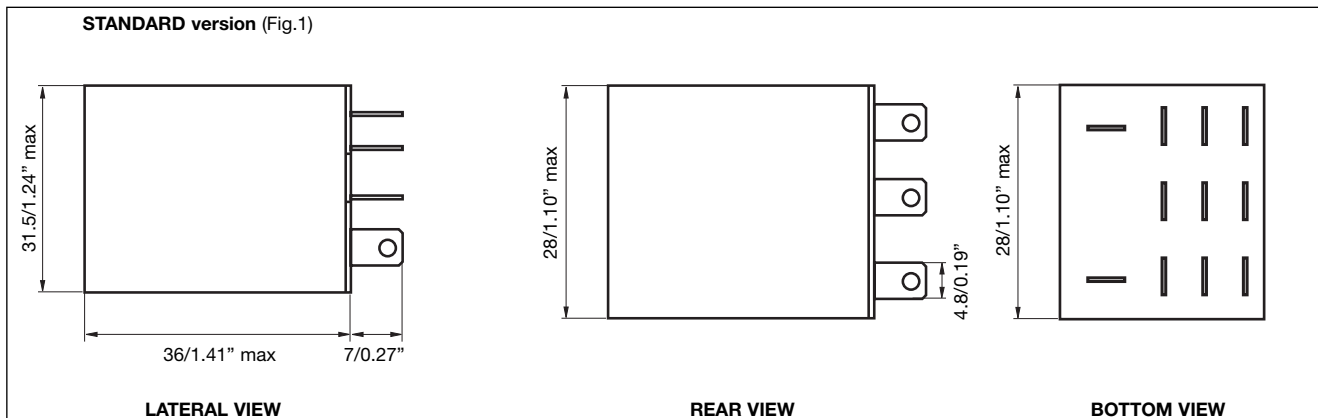

Diagrams

Max. switching current

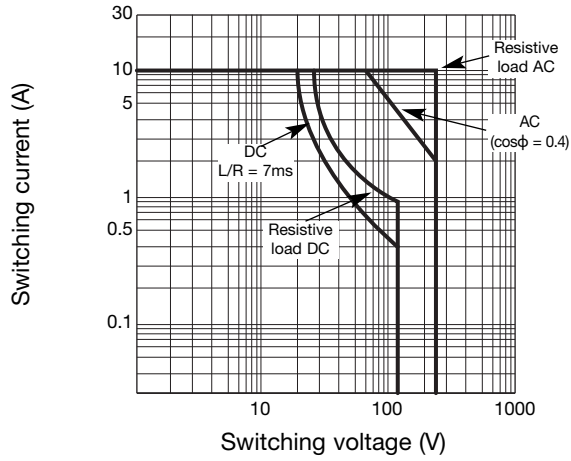

Electrical Life

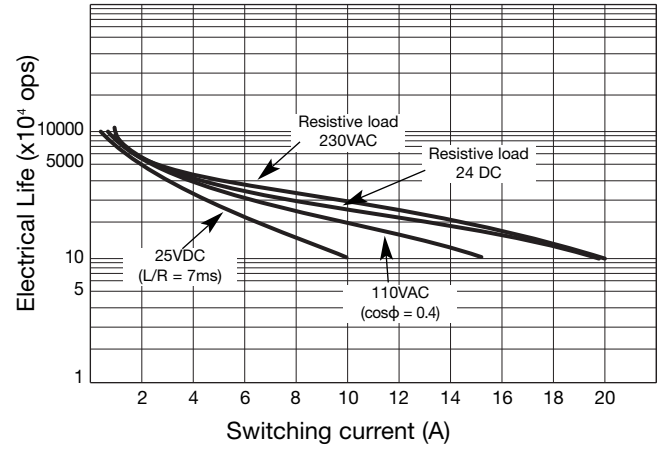

Temperature curve of coil

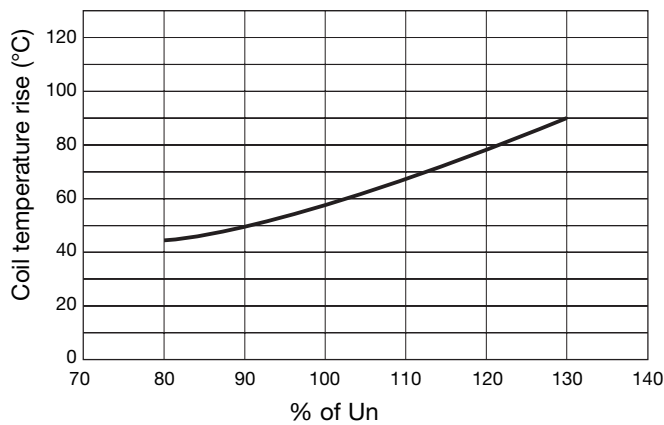

Bases and Sockets

DIN rail sockets code is **ZPY11A** details and specifications on page 69 of industrial relays catalogue.