



twist lever for position switch 3SE51 metal lever 27 mm long, Step 9 mm with Plastic roller 30 mm

product brand name	SIRIUS
product designation	actuator for part-turn actuator
product type designation	3SE5
manufacturer's article number	
<ul style="list-style-type: none"> <li>of the supplied operating lever</li> </ul>	<a href="#">3SE5000-0AA05</a>
<b>General technical data</b>	
product function positive opening	Yes
shock resistance	
<ul style="list-style-type: none"> <li>according to IEC 60068-2-27</li> </ul>	30g / 11 ms
vibration resistance	
<ul style="list-style-type: none"> <li>according to IEC 60068-2-6</li> </ul>	0.35 mm/5g
mechanical service life (operating cycles) typical	15 000 000
reference code according to IEC 81346-2	T
active principle	mechanical
Substance Prohibition (Date)	07/01/2006
Weight	0.02 kg
<b>Ambient conditions</b>	
ambient temperature	
<ul style="list-style-type: none"> <li>during operation</li> <li>during storage</li> </ul>	-25 ... +85 °C -40 ... +90 °C
explosion protection category for dust	none
<b>Enclosure</b>	
coating of the enclosure	Other types
<b>Drive Head</b>	
design of the actuating element	Twist lever, metal lever, 27 mm long, step 9 mm, plastic roller 30 mm
standard-compliant actuator head	EN 50041, design A
shape of the switch head	roller
outer diameter of the switch head	30 mm
<b>Installation/ mounting/ dimensions</b>	
mounting position	any
fastening method	screw fixing
design of the interface for safety-related communication	without
<b>Communication/ Protocol</b>	
design of the interface	without
<b>Approvals Certificates</b>	
General Product Approval	

[Confirmation](#)



[KC](#)



Functional Safety

Test Certificates

other

Environment



[Type Test Certificates/Test Report](#)

[Confirmation](#)

[Environmental Confirmations](#)

#### Further information

Information on the packaging

<https://support.industry.siemens.com/cs/ww/en/view/109813875>

Information- and Downloadcenter (Catalogs, Brochures,...)

<https://www.siemens.com/ic10>

Industry Mall (Online ordering system)

<https://mall.industry.siemens.com/mall/en/en/Catalog/product?mlfb=3SE5000-0AA05>

Cax online generator

<http://support.automation.siemens.com/WW/CAXorder/default.aspx?lang=en&mlfb=3SE5000-0AA05>

Service&Support (Manuals, Certificates, Characteristics, FAQs,...)

<https://support.industry.siemens.com/cs/ww/en/ps/3SE5000-0AA05>

Image database (product images, 2D dimension drawings, 3D models, device circuit diagrams, EPLAN macros, ...)

[http://www.automation.siemens.com/bilddb/cax\\_de.aspx?mlfb=3SE5000-0AA05&lang=en](http://www.automation.siemens.com/bilddb/cax_de.aspx?mlfb=3SE5000-0AA05&lang=en)

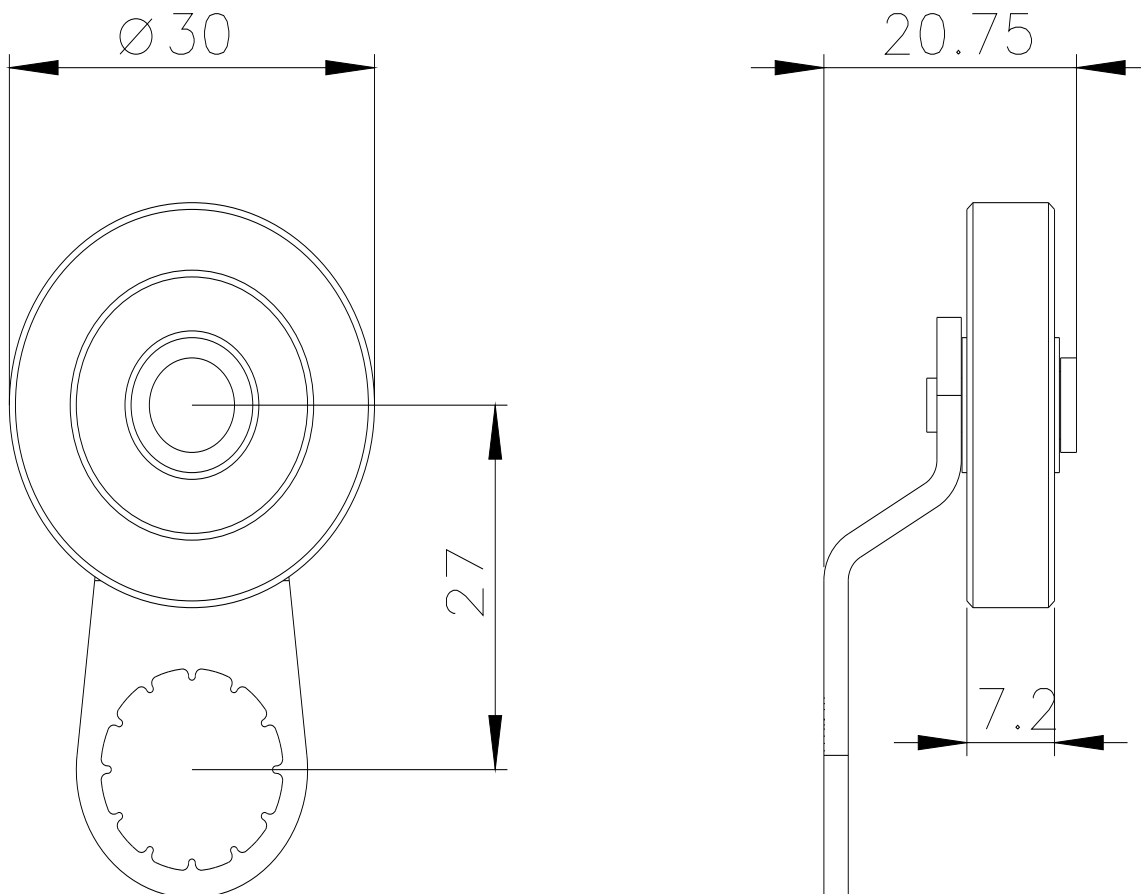

last modified:

12/21/2020