

Catalog Numbers • Les Numéros de Catalogue • Números de Catálogo: LMLS-400/LMLS-400-L

Country of Origin: Made in China • Pays d'origine: Fabriqué en Chine • País de origen: Hecho en China

Models ending in -U are BAA and TAA compliant (Product produced in the U.S.)

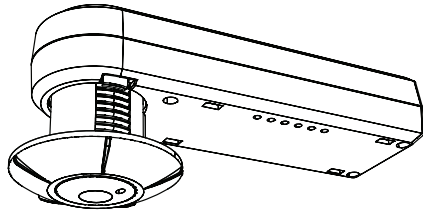

UNIT DESCRIPTION

The LMLS-400 is a closed loop photosensor that measures the ambient light level in order to automatically switch or dim one zone of lighting. It is part of the Digital Lighting Management (DLM) system and sends light level signals to control loads connected to DLM switching or dimming room controllers. The LMLS-400 has photodiodes with an extended range of 1-1,553 footcandles (fc), and photopic correction to mimic the human eye, for precise measurement of visible light.

The LMLS-400 operates on Class 2 power supplied to a DLM local network by one or more DLM room controllers. Plug n' Go automatic configuration assigns the photosensor to control load 1. Loads may be reassigned using an LMCT-100. Following a manual or automatic setup process, the LMLS-400 monitors the ambient light in the controlled space and works with the room controller(s) to maintain the design light level. The LMLS-400 uses switching or dimming setpoints and other control parameters to manage the light levels throughout the day regardless of changing daylight contribution.

Sensor Installation and Configuration Overview

1. Mount the photosensor so that the Photosensor Viewing Port views the daylight and electric light combined.
2. Complete all wiring and turn ON power to the room controller.
3. Use the LMCS-100 or LMCT-100 configuration tool to complete the configuration process. The LMLS-400 will not operate properly until the configuration and calibration is successful.
 - a. Select the LMLS-400 to be configured, from the Daylighting menu.
 - b. Use Zone Setup to select the operating mode for the controlled zone (Switched, Bi-Level, Tri-Level, or Dimmed).
 - c. Assign individual loads to the LMLS-400 controlled zone.
 - d. Calibrate the LMLS-400 either automatically or manually. If manual calibration is chosen a light meter will be required.
 - e. Adjust Zone Settings and Advanced Settings to meet specific sequence of operation requirements.
 - f. Use Test Mode to verify the LMLS-400 operation.

SPECIFICATIONS

Light sensor range 1 to 1,553 fc
 Voltage 24VDC
 Current Consumption max 13mA, typical 3mA
 Power Supply DLM Room Controllers
 Connection to the DLM Local Network 1 RJ45 port
 Environment:

Operating Temperature 32° to 131°F (0° to 55°C)
 Storage Temperature 23° to 140°F (-5° to 60°C)
 Relative Humidity 5 to 95% (non condensing)

Other:

RoHS compliant, 5-year warranty

Dimensions:

LMLS-400/400-L

Length 3.9" (99mm)

Width 1.2" (30mm)

Depth Minimum 1.0" (25mm)

..... Maximum 1.5" (38mm)

Tube Diameter 0.88" (22mm)

Ceiling Tile Thickness:

LMLS-400 0" - 5/8" (16mm)

LMLS-400-L 5/8" (16mm) - 1.25" (31mm)

Factory Defaults

Switching Operation:

ON Setpoint* 7.5 fc

OFF Setpoint* 11 fc

ON Time Delay 20 sec

OFF Time Delay 10 min

Dimming Operation:

Day Setpoint* 50 fc

Night Setpoint* 10 fc

Ramp Rate Up 20% per sec

Ramp Rate Down 2% per sec

Cut Off Delay Never

Advanced Parameters:

Allow Override No

Override Time Infinity

Hold OFF No

Scenes Stop Daylighting No

Ignore After Hours No

*Setpoints change automatically upon calibration

PLACEMENT GUIDELINES



WARNING: DO NOT USE THE DLM LOCAL NETWORK TO CONTROL LOADS OTHER THAN LIGHTING IF THE LOAD IS NOT IN VIEW OF A PERSON AT ALL CONTROL LOCATIONS. DO NOT USE DLM TO CONTROL ANY LOAD THAT MIGHT BE DANGEROUS OR CAUSE A HAZARDOUS SITUATION IF ACCIDENTALLY ACTIVATED.

The LMLS-400 switches or dims electric light in response to daylight. It is important to select a location where the daylight is representative of the daylight throughout the controlled zone. The photosensor must not directly view either the daylight source (window) or the electric lights, but instead should see the light from both, reflected from the work surfaces.

When the primary source of daylight is a window (sidelighting), the LMLS-400 is typically ceiling mounted within the daylit zone which extends 12 feet or less in from the window. Figure 1 shows a typical placement location for a sidelit application.

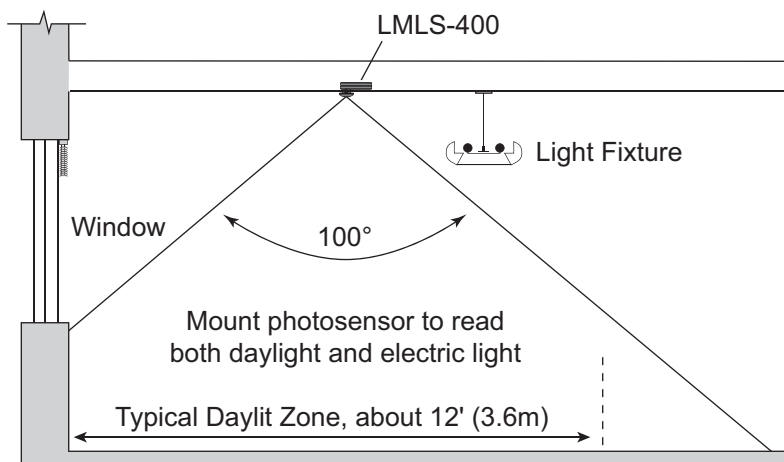

Fig. 1: Field of view, sidelighting application

IR COMMUNICATION

If the photosensor is mounted at ceiling heights greater than 20', communication with the photosensor must be through another IR enabled DLM device such as an occupancy sensor or a wallswitch.

Infrared signalling can be affected by high ambient light such as direct sunlight, floodlights, and some halogen or fluorescent lamps, as well as plasma screens.

Be sure to point the remote at a DLM IR enabled device that is within range. To test, see if you can put the local network into Push and Learn™ (PnL) mode using the remote from your current position.

- If not successful, move closer to the IR enabled local network device and more directly in front of it, or try pointing toward a different IR enabled device.
- If still not successful, the IR lenses on the DLM devices may be dirty. Clean the lenses with a soft material such as an eyeglass lens cleaning cloth.

CONNECT THE LMRJ CABLE



WARNING: NEVER CONNECT THE DLM LOCAL NETWORK TO A COMPUTER'S ETHERNET PORT. NEVER CONNECT AN ETHERNET CABLE TO A DLM DEVICE – DLM IS NOT COMPATIBLE WITH ETHERNET.

The LMLS-400 receives power and communicates with other DLM devices through a LMRJ cable that plugs into the RJ45 socket on the end of the unit.

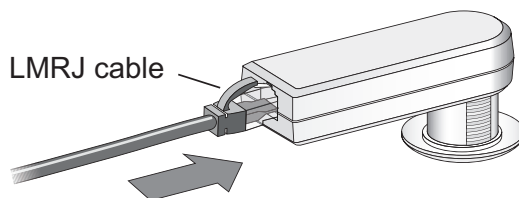
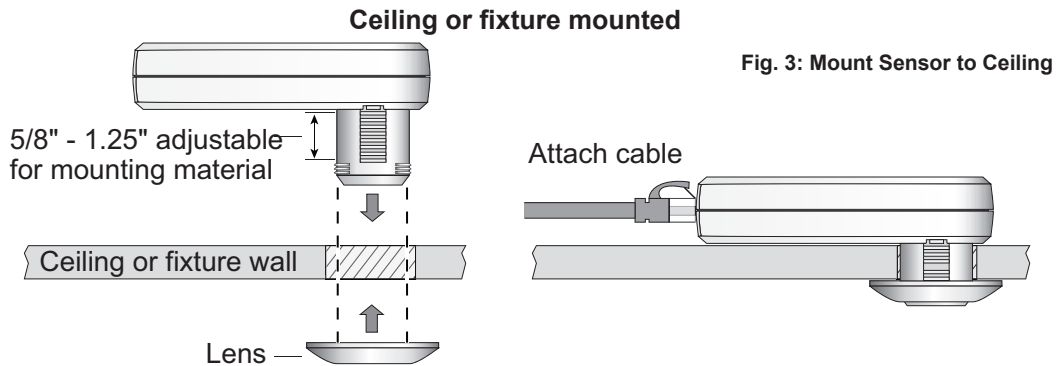

Fig. 2: Attaching the LMRJ Cable

MOUNTING THE PHOTSENSOR

In most applications, the unit will be mounted through a ceiling tile, with only the lens being visible from inside the room; the remainder of the unit will rest on top of the tile. The alternate mounting approach permits the unit to be affixed to hard surface. In these surface-mount applications, an accessory plastic mounting bracket is required. An accessory for mounting the unit to a J-Box is also available. The device has an adjustable head to accommodate multiple mounting methods and building materials or fixture walls.



NOTE: For ceiling thickness lower than 5/8", the LMLS-400 must be used.

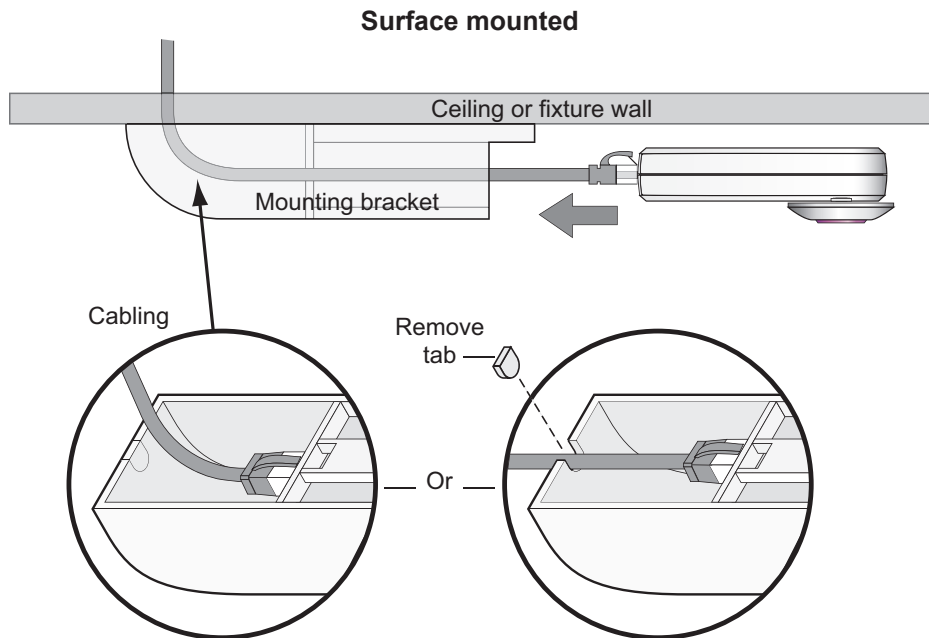

Fig. 4a: Surface Mount using LMLS-MB2 Mounting Bracket

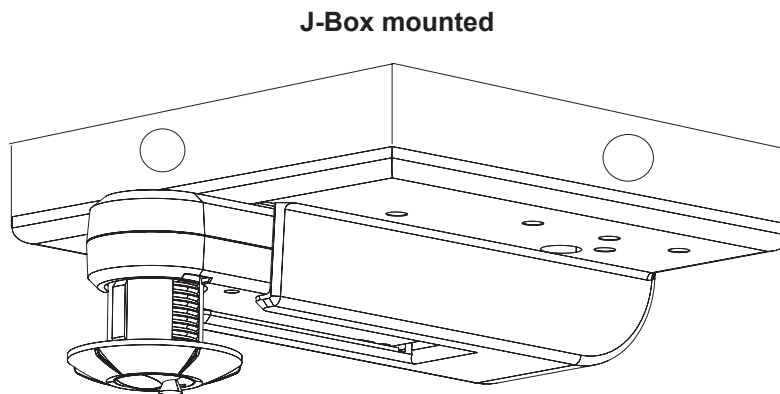

Fig. 4b: Surface Mount using LMLS-MB1 J-Box Mounting Bracket

NOTE: In surface- or J-Box mounted applications, the shorter-tube LMLS-400 model is recommended.

WIRING DIRECTIONS

Installation shall be in accordance with all applicable regulations, wiring practices, and codes.

The DLM Local Network is free topology low voltage wiring. The LMLS-400 can connect anywhere on the DLM Local Network. The following illustration is for EXAMPLE only.

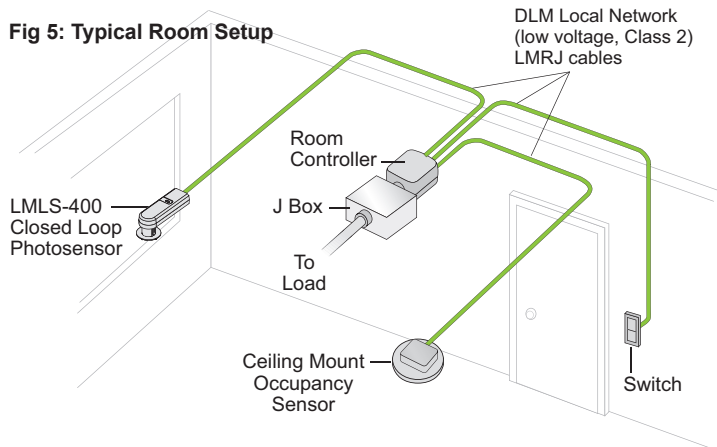

STATUS LEDs

Blue and red status LEDs are located in the sensor dome and are visible from all angles when lit or flashing.

Red LED

- Flicker for 0.5 second = IR message received
- Flashing once per second = PnL mode
- On 3 seconds, off 1 second and repeat = Daylighting control is disabled
- Solid = Sensor failure

Blue LED

- Flash once per second = Test or Demo mode
- Flashing once every 4 seconds = Override mode
- Solid = Load binding test or PnL mode display

OPERATION

The LMLS-400 communicates with all other Lighting Management devices connected to the DLM Local Network. It is dependent on a DLM Room Controller (LMRC-100 series for On/Off switched loads, LMRC-200 and -300 series for On/Off switched loads and dimming capable loads), DLM Switches for override control, and DLM Occupancy Sensors for motion detection.

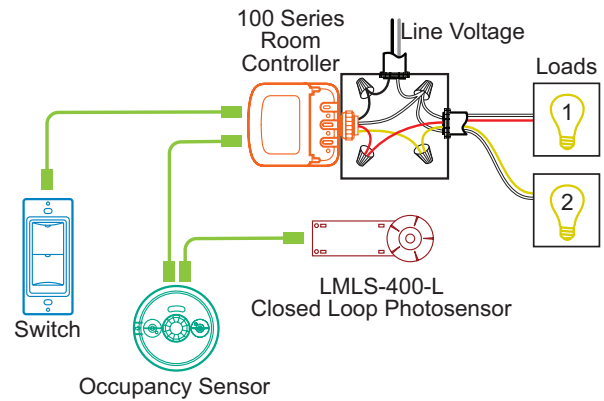

Fig. 6: DLM Local Network Example for Switch Loads

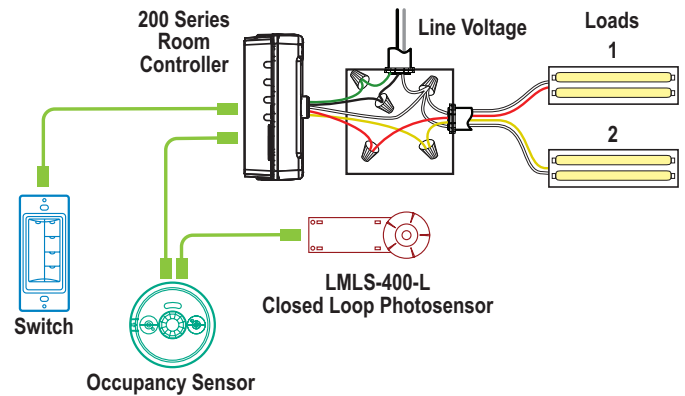

Fig. 7: DLM Local Network Example for Dimming and Switch Loads

SENSOR PUSHBUTTONS

USER Button

Quick press – cycle through load binding verification test

Press and hold for two seconds – start automatic calibration (first, relinquish load binding verification test if active)

CONFIG Button

- **Quick press** – if the system is not presently in PnL mode, the red LED will flash once. If the system is in PnL mode at the time of the press, the system will advance to select the next load on the IRB in sequence.
- **Press and hold for 2 seconds** – when the button has been held down for two seconds, the red LED will flash; releasing the button at this time will cause the system to enter PnL mode if it is not presently active (and the red LED will begin to flash slowly), or exit PnL mode if active (and cause the red LED to cease flashing).
- **Press and hold for 10 seconds** – when the button has been held down for ten seconds, the red LED will stop flashing and turn on solid; releasing the button at this time will cause the LMLS-400 to clear its load bindings, but otherwise leave its internal parameters unmodified.
- **Press and hold for 20 seconds** – if the button is held down for twenty seconds or more, the red LED again starts to flash; releasing the button at this time will cause the device to completely reset to its factory defaults, and remove any configuration locks (i.e., Plug n' Go™ (PnG) mode will be reenabled).

Fig. 8: USER Button

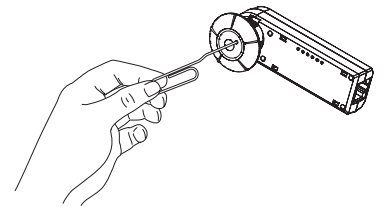
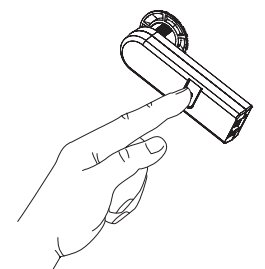

Fig. 9: CONFIG Button



OPERATING MODES

Plug n' Go

The default operating mode for the LMLS-400 is Plug n' Go™ (PnG). Upon initial power up, the system automatically takes inventory of the devices on the DLM Local Network and allows immediate operation of devices in the most energy efficient manner. When only one LMLS-400 is found, it is automatically assigned to Load 1. Based on the attributes of the room controller, the LMLS-400 will configure itself to Switching or Dimming Mode.

Push n' Learn

Push and Learn™ (PnL) mode provides for remote load binding and configuration within the room, without requiring direct access to the Room Controller(s). While the LMLS-400 must be configured through the use of a configuration tool (e.g., LMCT-100), the CONFIG button at the back of the product can be used to force the system into or out of PnL mode, and/or to step to the next load in sequence, when configuring devices other than the LMLS-400.

Confirmation of Load Binding

To provide a confirmation of load bindings after installation, a quick press using a paper clip on the USER button sequences through three states:

1st press - all controlled loads forced ON at 100%

2nd press - all controlled loads forced OFF at 0%

3rd press - exit load binding confirmation mode and resume normal control. (Confirmation mode cancels automatically after 5 minutes if no further action is taken after the 1st or 2nd press.)

Test Mode

In Test Mode, time delays are reduced to 5 seconds (to create near-immediate reactions to changes in measured light levels), and the ramp rate increases to 20%/second (to cause the changes to be immediately visible).

To activate Test Mode, press and hold the USER button for 2 seconds or use a configuration tool. If not cancelled by the user, the controller automatically exits Test Mode after 5 minutes.

User Override of Levels Set by Daylighting Control

The electric light levels of loads configured for daylighting control can be adjusted from DLM wall switches, within limitations established by LMLS parameters that are set using the Advanced Settings screen of the LMCT-100.

The light level can always be reduced (by turning off loads in a switched zone, or by lowering the level of loads in a dimmed zone) without restriction. When a load is dimmed down from its daylighting-permitted level, the new level set becomes the maximum electric light level for that load (a "cap" level), regardless of daylight contribution, until the load is turned off and back on again, or until the level is adjusted upwards. If a load has been dimmed, a single tap on the top of a controlling switch's rocker will return the level to the maximum allowed by daylighting at that time, and cancel the level restriction ("cap") set by the earlier user adjustment.

Increasing the light level above that set by daylighting is possible only if **Allow Override** is set to **Yes** (the default is **No**). For switched modes, this means that the loads can be turned on even when the present ambient light level is above the On Setpoint. In the case of dimmed mode, a load will turn on and adjust to its daylighting-permitted level, but a subsequent tap on the top of a controlling switch will increase the level to maximum. In either mode, the affected loads will be temporarily removed from daylighting control, and be placed in an "override" state. The levels of the overridden loads can be changed or adjusted, and they will not return to daylighting control unless they are turned off and back on again (for example, by a cycle of occupancy).

If the **Override Time** parameter is changed from its default (Infinity) to a fixed time (e.g., 1 hour), all loads presently overridden will return to automatic daylighting control after the selected time period lapses.

Any loads not affected by the switch actions causing the override will continue to be controlled by daylighting; overrides occur on a load-by-load basis.

If any daylighting loads are presently overridden, the blue LED in the sensor head will flash once every four seconds.

To provide the ability to set arbitrary light levels in Dimmed applications, a switch with a dimming control rocker (e.g., LMDM-101 or LMSW-105) should be used.

Scene Control and Daylighting

Setting a new light level using a scene switch is possible, provided **Hold Off** is set to **No** (default). Such a light level change is not considered an override. If daylighting control is active when the new scene is selected, daylighting control suspends until the new scene is displayed, and then resumes, with the new light level established by the scene as the maximum electric light level ("cap" level), on a load-by-load basis, until a subsequent user action changes the level. Any daylighting loads not included in the scene will continue to operate as before the recall.

Optionally, daylighting control can be temporarily disabled for any loads on which a scene has been recalled. If **Scenes Stop DL** is set to **Yes**, daylighting control for a load affected by a scene will not resume until the level of the load is changed by another user action, or the load is turned off and on again.

CONFIGURATION

The configuration process establishes the appropriate parameters for operation. This is done through the use of an LMCT-100 configuration tool. If no configuration steps are taken, the sensor will use its default values for setpoints.

The LMCT-100 Wireless IR Configuration Tool is a handheld tool for setup and testing of WattStopper Digital Lighting Management (DLM) devices. It provides wireless access to occupancy and daylighting sensors for setup and parameter changes, WattStopper Push n' Learn™ (PnL) technology for load configuration, switch and dimmer assignment and operating parameter changes. The LMCT-100's display shows menus and prompts to lead you through each process. The navigation pad provides a familiar way to navigate through the customization fields. The LMCT-100 allows modification of the system without requiring ladders or tools; simply with a touch of a few buttons.

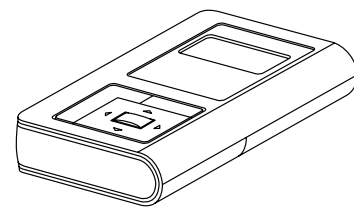

Fig. 10: LMCT-100

Operation

The LMCT-100's IR transceiver allows bi-directional communication between DLM devices and the LMCT-100. Simple menu screens let you see the current status of the system and make changes. It can change any of the DLM occupancy sensor parameters such as sensitivity, time delay and more. With the LMCT-100 you can also change load configurations, without any new wiring.

For systems including the LMLS-400 Daylighting sensor the LMCT-100 can also set or change the daylight level parameters. The LMCT-100 can change dimming system options such as scene assignments, ramp rates and other options not available through the standard user interface.

Batteries

The LMCT-100 operates on three standard 1.5V AAA Alkaline batteries or three rechargeable AAA NiMH batteries.

The battery status displays in the upper right corner of the display. Three bars next to **BAT=** indicates a full battery charge. A warning appears on the display when the battery level falls below a minimum acceptable level.

To conserve battery power, the LMCT-100 automatically shuts off 10 minutes after the last key press.

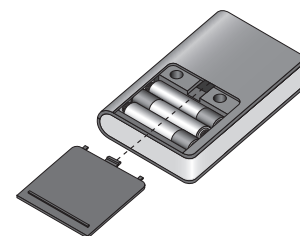

Fig. 11: Battery Location

Navigation

You navigate from one field to another using ▲ (up) or ▼ (down) arrow keys. The active field is indicated by flashing (alternates between yellow text on black background and black text on yellow background).

Once active, use the **Select** button to move to a menu or function within the active field.

Value fields are used to adjust parameter settings. They are shown in "less-than/greater-than" symbols: <value>. Once active, change them using ◀ (left) and ▶ (right) arrow keys. In general the ▶ key increments and the ◀ key decrements a value. Selections wrap-around if you continue to press the key beyond maximum or minimum values. Moving away from the value field (using ▲ / ▼ keys) overwrites the original value.

The Home button takes you to the main menu.

The Back button can be thought of as an undo function. It takes you back one screen. Changes that were in process prior to pressing the Back key are lost.

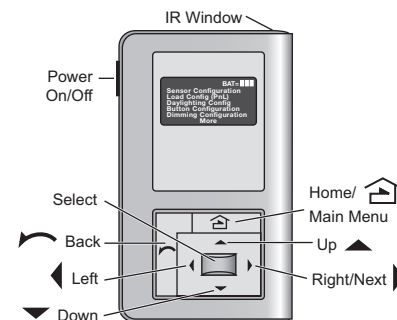
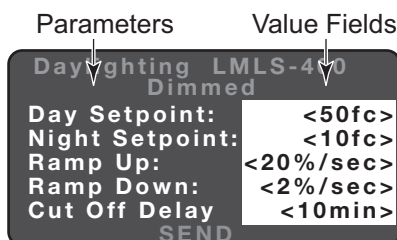
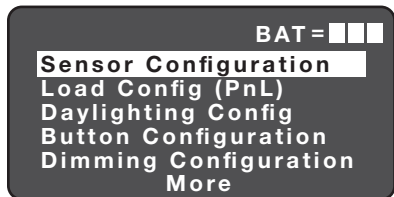

Fig. 12: LMCT-100 Controls

Function Fields (on Home Menu)



Home Menu

The Home (or Main) menu displays after the power-up process completes. It contains information on the battery status and six menu choices. Press ▲ / ▼ to locate the desired function then press **Select**.

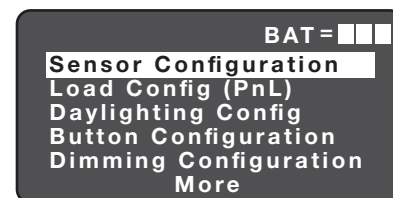

LMLS-400 CONFIGURATON PROCESS

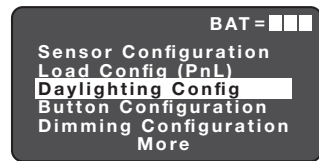

Choose Daylighting Config ▼ Press Select

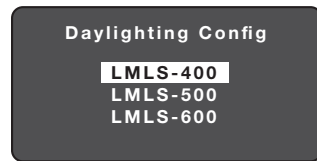

Choose the Desired Model ▼ Press Select

Specific Photosensor

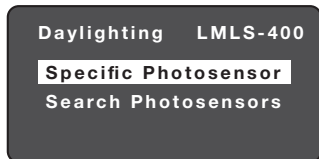

Press Select

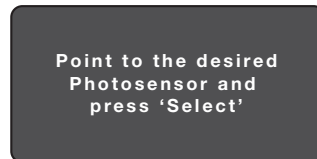

Point and Press Select

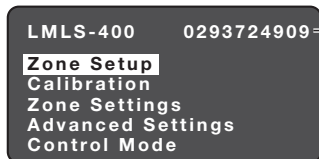

Serial number will be different for each LMLS-400

SEARCH PHOTOSENSOR

The Search Photosensor function allows you to identify which LMLS-400 will be commissioned. After enabling and pointing the LMCT-100 at any DLM device, a list of all LMLS-400s in the DLM Local Network appears on the screen. Each LMLS-400 has its own serial number.

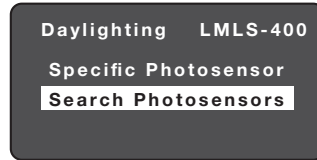

Choose Search Photosensors ▼ Press Select



Point and Press Select

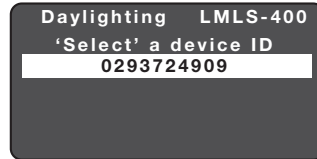

Choose Desired Photosensor ▼ Press Select



Point and Press Select

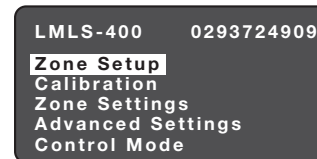

Serial number will be different for each LMLS-400

LMLS-400 Daylighting Menu

ZONE SETUP

Selecting the Operation Mode

Zone Setup allows you to select and change the Operation Mode of a zone, specify if a selected load is to be controlled by Daylighting and to bind loads to the LMLS-400.

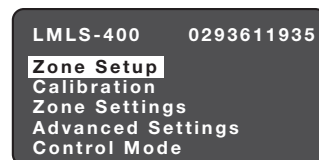

Press Select



Press Left/Right arrow to choose the desired operation mode:
<Switched>, <Bi-Level>, <Tri-Level> or <Dimmed>



Choose CONTINUE ▼ Press Select



Point and Press Select

After choosing Zone Setup and pressing Select, the current operation mode is displayed. This can be changed to Switched, Bi-Level, Tri-Level, or Dimmed.

Switched

Switched mode provides ON/OFF switching within the daylighting zone controlled by the photosensor.



Bi-Level

Bi-level mode provides three light levels within the daylighting zone controlled by the photosensor by using 2 load circuits.

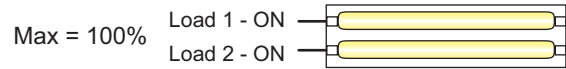
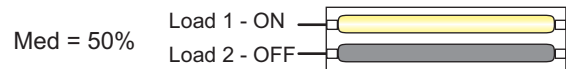
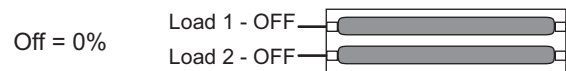

Tri-Level

Tri-level mode provides four light levels within the daylighting zone controlled by the photosensor by using 2 load circuits.

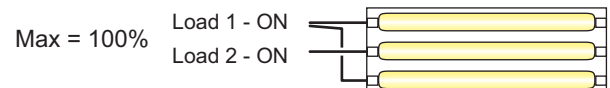
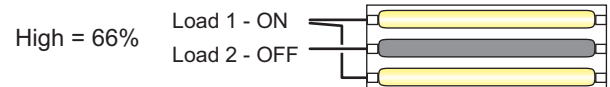
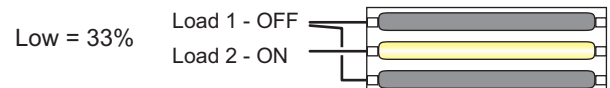
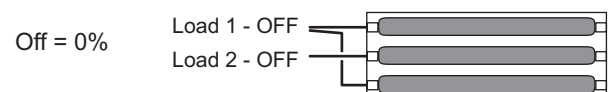

ZONE SETUP (CONTINUED)

Dimmed

Dimmed mode provides continuous dimming within the daylight zone controlled by the photosensor.

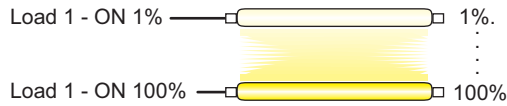

Switched and Dimmed Load Assignment

The load binding process for Switched loads and Dimmed loads is the same.

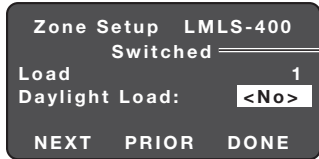

Depending on the Operation Mode, the screen display will be Switched or Dimmed

Load 1: Press Left/Right arrow to choose <Yes> or <No>

To do load binding the load needs to be assigned as a Daylight Load by selecting <Yes>.

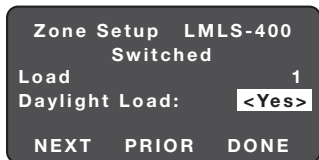

Next

To continue to assign Daylight Load binding to load 2, choose NEXT.

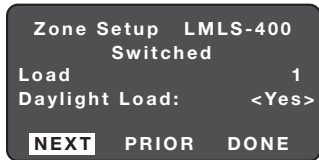

Choose NEXT

Press Select

Point and Press Select

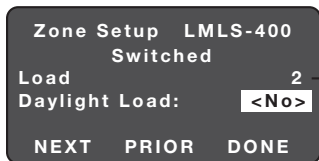

Zone settings for the next load are displayed.

Prior

To continue to assign Daylight Load binding to the previous load, choose PRIOR. This function behaves the same for all Operation Modes.

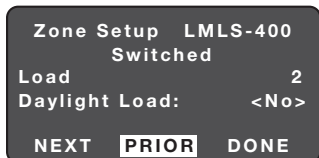

Choose PRIOR

Press Select

Point and Press Select

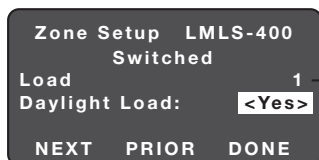

Zone settings for the prior load is now displayed.

Done

When you have completed all load bindings, choose DONE. This function behaves the same for all Operation Modes.

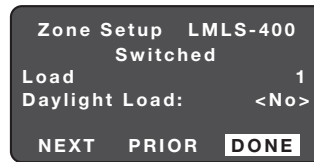

Choose DONE

Press Select

Point and Press Select

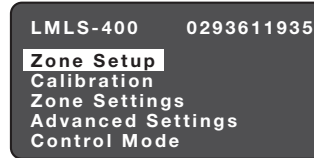

Zone Setup settings have been saved. The screen returns to the Daylighting Parameters menu.

Bi-Level Load Assignment

To do load binding the load needs to be assigned as a Daylight Load by selecting <Yes>.

Next, Prior and Done process is the same as Switched and Dimmed.

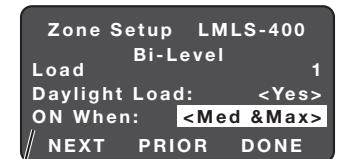
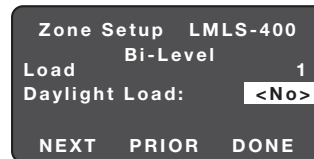

For Load 1: Press Left/Right arrow to choose <Yes> or <No>

Press Left/Right arrow to choose <Med & Max> or <Max>

If <Yes> is selected, ON When appears

Tri-Level Load Assignment

To do load binding the load needs to be assigned as a Daylight Load by selecting <Yes>.

Next, Prior and Done process is the same as Switched and Dimmed.

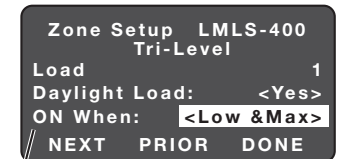
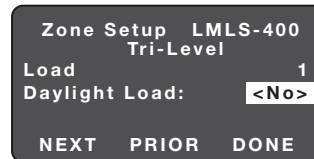

For Load 1: Press Left/Right arrow to choose <Yes> or <No>

Press Left/Right arrow to choose <Hi & Max> or <Low & Max>

If <Yes> is selected, ON When appears

Bi-Level Sequence of Operation*

When the ambient light level reaches the **OFF Setpoint** again, the **Med & Max** assigned load turns **OFF**.

When the ambient light level reaches the **OFF Setpoint**, the **Max** assigned load turns **OFF**.

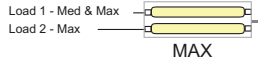
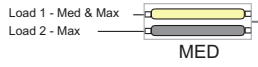
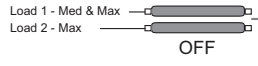

Off/Med/Max

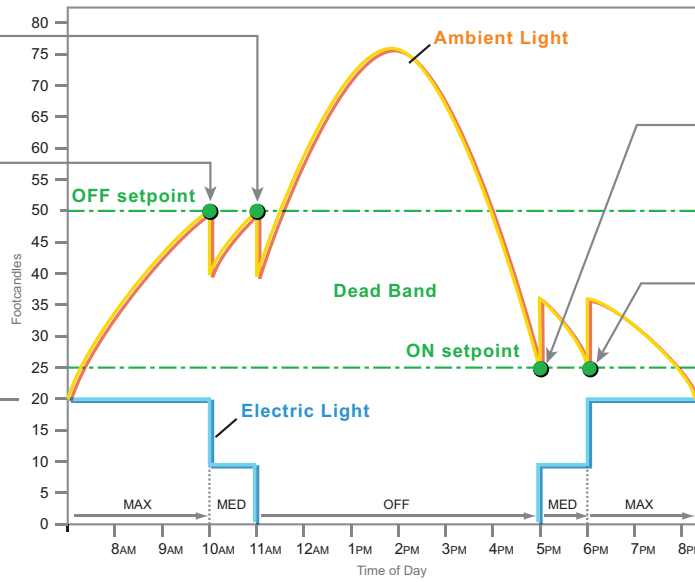

When the ambient light level reaches the **ON Setpoint**, the **Med & Max** assigned load will turn **ON**.

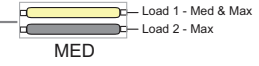

When the ambient light level reaches the **ON Setpoint** again, the **Max** assigned load turns **ON**.

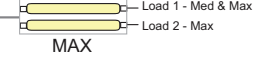

Tri-Level Sequence of Operation*

When the ambient light level reaches the **OFF Setpoint** three times, the **Low & Max** load turns **OFF**.

When the ambient light level reaches the **OFF Setpoint** twice, the **Low & Max** load turns **ON** and the **High & Max** load turns **OFF**.

When the ambient light level reaches the **OFF Setpoint**, the **High & Max** load turns **OFF**.

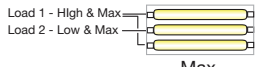
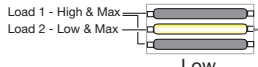
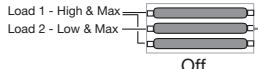

Off/Low/High/Max

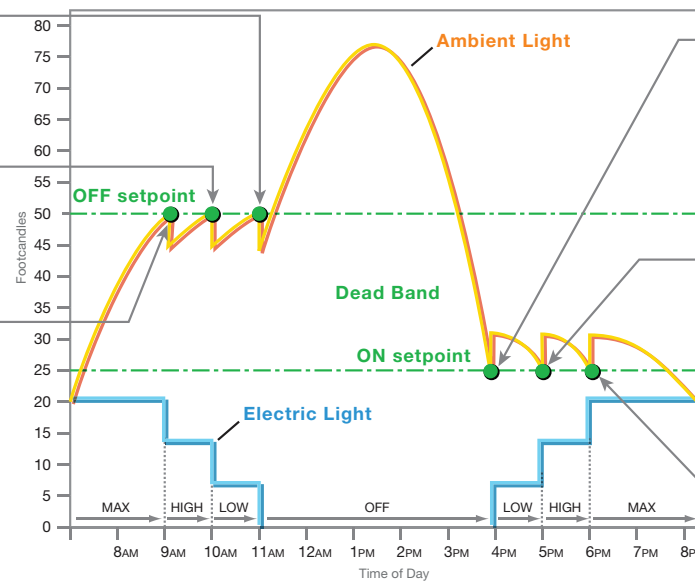

When the ambient light level reaches the **ON Setpoint**, the **Low & Max** load turns **ON**.

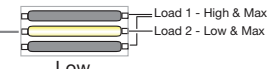

When the ambient light level reaches the **ON Setpoint** twice, the **Low & Max** load turns **OFF** and the **High & Max** load turns **ON**.

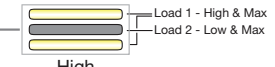

When the ambient light level reaches the **ON Setpoint** three times, the **Low & Max** assigned load turns **ON**.

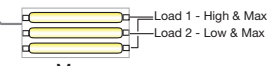

NOTE: This figure is intended to provide a visual interpretation of how the unit works. Actual ON/OFF setpoints will vary depending on light conditions.

CALIBRATION

Calibration establishes a relationship between the workplane illuminance and the light level measured by the sensor. This can be done Automatically or Manually.

Automatic Calibration

Automatic Calibration can be started by the LMCT-100, or by pressing and holding the user pushbutton located in the sensor head.

1. Complete all wiring and turn power on to the connected room controller.
2. Press and hold the user button for at least 2 seconds then release, or activate automatic calibration from the LMCT-100.
3. Blue LED will start flashing once every 4 sec.
4. Daylighting controlled loads will automatically turn ON for 2 minutes to allow controlled lamps to warm up and reach a stable full output.
5. Remove any objects that may affect the LMLS-400 light level reading (ladder or temporary objects).
6. Lights will cycle eight times for automatic setpoint selection.
7. The photosensor is in Test Mode when the blue LED starts flashing once per second. For the next 5 minutes the sensor will be in Test Mode.
8. Verify the setpoints automatically selected by the photo sensor with the LMCT-100. If the automatic selected setpoints are not acceptable, proceed to manual calibration.

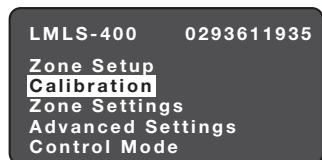

Choose Calibration Press Select

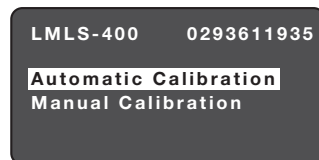

Press Select

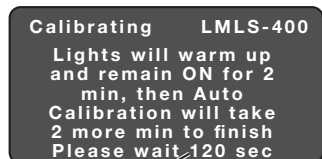

Counts down from 120 seconds then returns to the Main Menu; the Automatic Calibration process continues for 2 minutes, with the controlled loads switching ON and OFF, then the sensor enters Test Mode for 5 minutes.

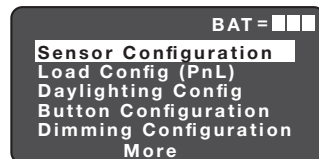

Main Menu

Manual Calibration

Depending on how the Operation Mode is configured under Zone Setup, one of the following screens is displayed (Switched, Bi-Level, Tri-Level, or Dimmed)

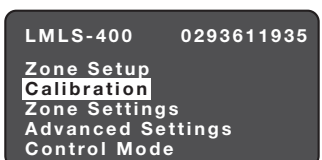

Choose Calibration Press Select

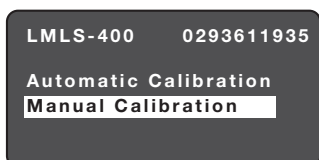

Choose Manual Calibration Press Select

Switched, Bi-Level and Tri-Level

Choose a reference location within the daylighting zone that is most likely to have the lowest light level when daylight and is located farthest from the window.

To set the On and Off Setpoints automatically to best match a designed light level for the workplane, enter the desired level, along with the present measured level (from a light meter), and then press SEND.

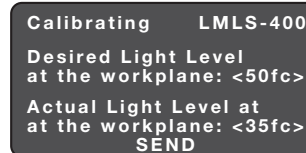

Press Select

Dimmed

Day Setup

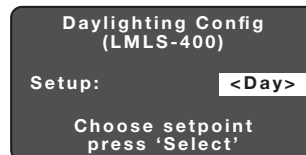

Press Left/Right arrow to choose <Day> or <Night> Press Select

Point and Press Select

Make this adjustment when there is enough daylight when there is enough daylight to provide 40% to 90% of the target light level. For example, if the target is 40 footcandles, make this adjustment when the daylight contribution is between 16 and 36 footcandles.

1. Press the Day button.
2. Using a light meter at the task surface, press the Up and Down LMCT-100 arrows to adjust light levels.
3. Once the target level has been reached, press the Select button to hold the value.
4. When Day and Night adjustments are complete, press HOME to terminate the calibration process and return to normal operation.

To set the desired light level, point to the LMLS-400 and continue pointing to it while pressing the ▲ / ▼ keys. The ▲ key increments and the ▼ key decrements the light level.

Night Setup

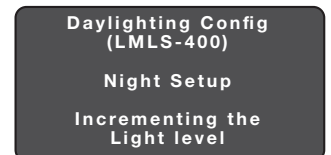
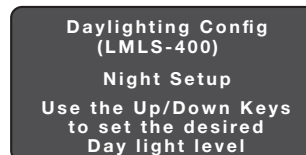

Press Up/Down arrow Increment (raise) Decrement (lower)

Continue adjusting pressing the Up or Down arrow until desired Light Level is achieved

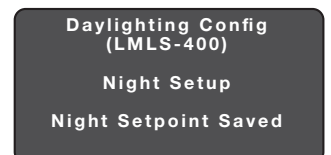
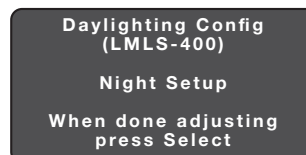

Press Select

To set the desired light level, point to the LMLS-400 and continue pointing to it while pressing the ▲ / ▼ keys. The ▲ key increments and the ▼ key decrements the light level.

When Day and Night adjustments are complete, press the HOME key to terminate Manual Calibration and return to normal operation.

ZONE SETTINGS

Zone Settings allows you to modify the photosensor Daylighting Setpoints, Time Delays and Ramp Rates.

When Zone Settings is selected, one of two screens is displayed depending on the Operation Mode of the device (Switched, Bi-Level, or Tri-Level) or (Dimmed)

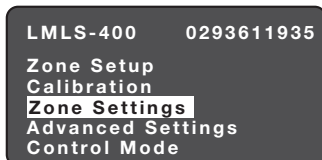

Send

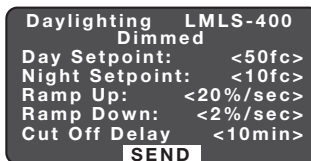

Press the Down Arrow to choose SEND



Point and Press Select

Switched, Bi-Level or Tri-Level

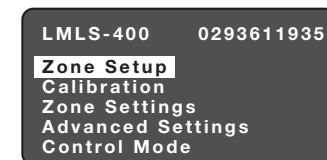
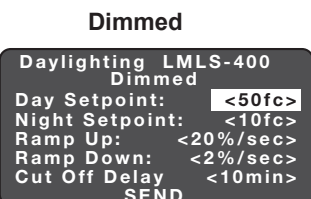
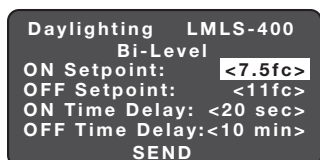

Zone Settings have been saved. The screen returns to the Daylighting Parameters menu.

Switched, Bi-Level, or Tri-Level

ON Setpoint

The target illuminance level at the sensor, below which the LMLS-400 turns the lights ON.

The ON Setpoint values available for manual adjustment are: 1.0, 1.2, 1.5, 1.8, 2.2, 2.7, 3.3, 4.0, 5.0, 6.0, 7.5, 9.0, 11, 13, 16, 20, 25, 30, 35, 45, 60, 90, 125, 180, 250, 325, 400, 475, 550, 625, 700, 775 and 850 footcandles; note that calibration can automatically select a value not in this list.

This heading differs depending on Operation Mode

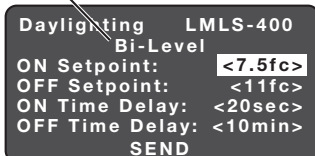

Press Left/Right arrow to raise or lower ON Setpoint footcandles

OFF Setpoint

The target illuminance level at the sensor, above which the LMLS-400 turns the lights OFF.

The OFF Setpoint corresponds to the ON Setpoint multiplied by 1.25, 1.50, 1.75 or 2.0. This ensures that the OFF Setpoint is always higher than the On Setpoint.



Press Left/Right arrow to raise or lower OFF Setpoint footcandles

ON Time Delay

The time interval that must elapse, with the measured level below the ON Setpoint, before the controlled lights turn on.

Range: 1 sec to 60 sec.

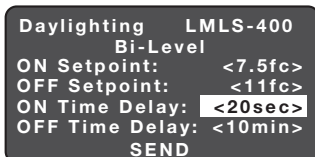

Press Left/Right arrow to raise or lower ON Time Delay <1sec - 60sec>

OFF Time Delay

The time interval that must elapse, with the measured level above the OFF Setpoint, before the controlled lights turn OFF.

Range: 3 min to 30 min.



Press Left/Right arrow to raise or lower OFF Time Delay <3min - 30min>

Dimmed

Day Setpoint

The desired light level at the sensor during daytime. To determine the correct dimming level for any given photocell reading, it calculates the level based on the slope between the day and the night setpoint.

Range: 1 fc to 255 fc.

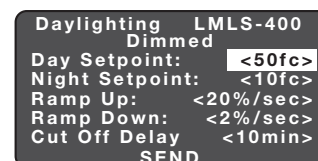

Press Left/Right arrows to increase or decrease footcandles

Night Setpoint

The desired light level at the sensor during nighttime. To determine the correct dimming level for any given photocell reading, it calculates the level based on the slope between the day and the night setpoint.

Range: 1 fc to 255 fc.



Press Left/Right arrows to increase or decrease footcandles

NOTE: The Day Setpoint must always be greater than the Night Setpoint.

Ramp Up

Determines the speed (or rate) at which the light level of bound loads increases. The default is 20% per second because the end user needs light quickly.

Range: 1% per second to 100% per second.

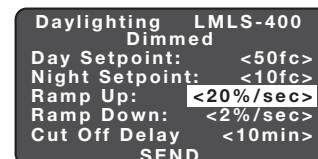

Press Left/Right arrows to increase or decrease Fade Up time (5sec - 60sec)

Ramp Down

Determines the speed (or rate) at which the light level of bound loads decreases. The default is 2% per second because a slow ramp down will help the eye adapt to the new light level.

Range: 1% per second to 100% per second.

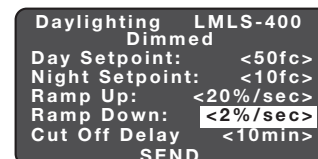

Press Left/Right arrows to increase or decrease

Cut Off Delay

The time that the controlled lighting will remain at a minimum dimmed level, even with high daylight contribution, before the lights will be switched OFF.

Range: Never to 30 min.

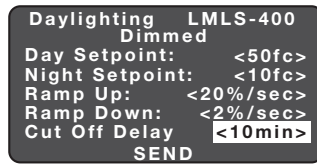

Press Left/Right arrows to increase or decrease Cut Off Delay (Never - 30 min)

Send

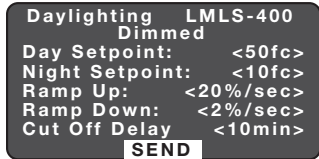

Press the Down Arrow to choose SEND

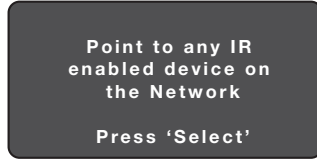

Point and Press Select

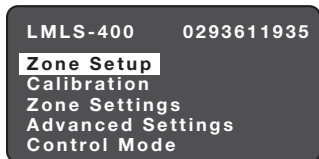

Zone Settings have been saved. The screen returns to the Daylighting Parameters menu.

ADVANCED SETTINGS

Advanced Settings allows you to see the light level at the photocell, adjust the override mode, the override time delay, hold off, scene switch and after hours interaction.

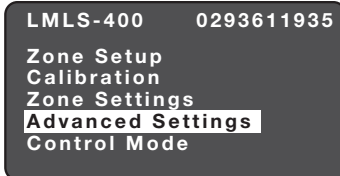

Light Level

Present light level measured at the LMLS-400.

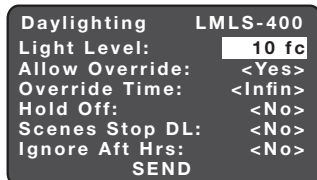

Allow Override

Determines if overriding the photosensor is permitted or not.

Available choices: Yes or No.

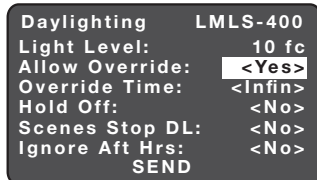

Override Time

Override Time selects the delay, after daylighting control has been disabled due to an observed external user or system action, before automatic control resumes.

Range: Infinity or 1 to 24 hours.

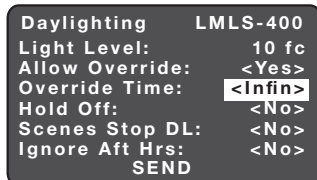

Hold Off

The Hold Off setting selects the behavior of daylighting loads when they are turned ON, by a switch or occupancy sensor.

If Hold Off = <No> (default), the loads can always be turned on to their previous level, and then will begin to adjust based upon daylight.

If Hold Off = <Yes>, the sensor will limit the loads to the level presently allowed by daylight contribution. This means that the loads may not initially turn ON (if the ambient light level is high - above the ON or Dimming Setpoint), but will become active for daylighting control, and will turn ON or dim up as daylight contribution drops."

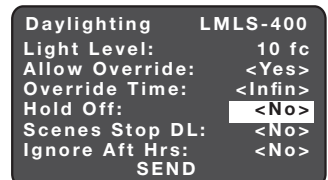

Scenes Stop DL

When set to No, the sensor allows daylighting to adjust light levels, up to the level recorded in the Scene, even though a scene is active. When set to Yes, daylighting control is disabled for any loads on which a scene is recalled until a change is manually made to the level of a load in the zone, or until the next cycle of occupancy.

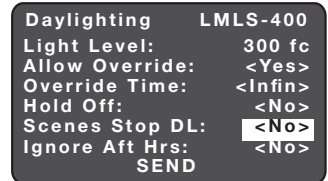

Ignore After Hours

When set to Yes, the photosensor will ignore After Hours and will continue to operate as normal.

When set to No, the daylighting controlled loads that are set to After Hours mode will be temporarily removed from daylighting control while in the After Hours state.

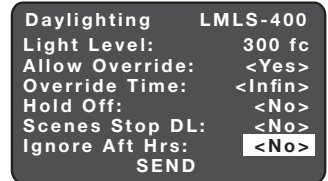

Send

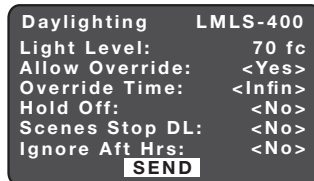

Choose SEND then Press 'Select'



Point and Press Select

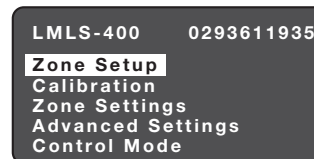

LMLS-400 Daylighting Menu

Ignore After Hours have been saved. The screen returns to the Daylighting Parameters menu.

CONTROL MODE

Control Mode allows you to select the control behavior of the photosensor. After choosing Control Mode and pressing Select, point to the LMLS-400 and press Select. The current control mode is displayed. This can be changed to Normal, Test, Demo, or Disable.

Press the left/right arrow to scroll through the options.

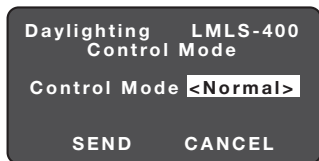
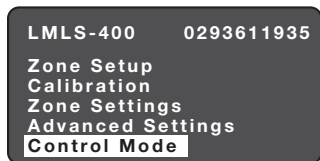

Demo:

Demo mode will allow the photosensor to select a set of preset parameters. This mode should only be selected when demonstrating the functionality of the unit is desired.

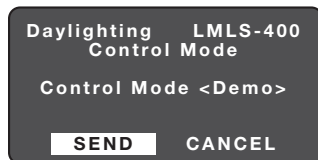

Press Left/Right arrow to choose <SEND> or <CANCEL>

Point and Press Select

Normal:

Normal mode allows the photosensor to take control of the daylighting loads.

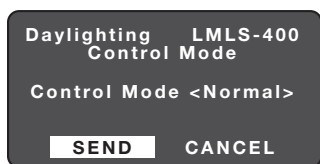

Press Left/Right arrow to choose <SEND> or <CANCEL>

Point and Press Select

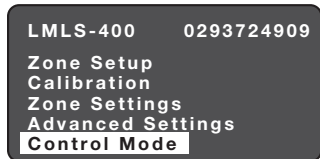

Control Mode has been saved. The screen returns to the Daylighting Parameters menu.

Disable:

Disable mode prevents the LMLS-400 from controlling any daylighting loads. This parameter is mostly used for troubleshooting purposes.

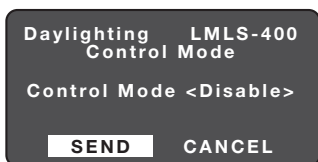

Press Left/Right arrow to choose <SEND> or <CANCEL>

Point and Press Select

Test:

Test Mode shortens timeouts for switching operation, and speeds ramp rates for dimming operation, to allow quick verification. Test Mode cancels automatically after 5 minutes.

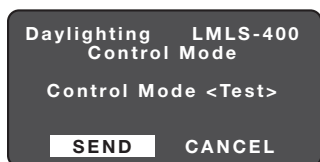

Press Left/Right arrow to choose <SEND> or <CANCEL>

Point and Press Select

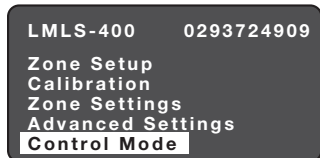

Control Mode has been saved. The screen returns to the Daylighting Parameters menu.

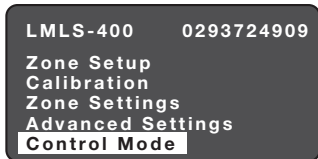

Control Mode has been saved. The screen returns to the Daylighting Parameters menu.

TROUBLESHOOTING

Lights do not switch or dim when desired, under daylight control

- Use the pushbutton on the photosensor face to manually test load control (see SENSOR PUSHBUTTONS on page 3). If the lights do not switch on and off, check Zone Setup to rebind the loads.
If the lights do switch on and off, use the Zone Settings screen to verify that the On and Off setpoints are correct (if Switched / Bi-Level / Tri-Level) or Day and Night setpoints are correct (if Dimmed). Place the photosensor in Test Mode to quickly verify daylighting operation; shine a flashlight into the sensor, or cover the sensor, to simulate major light level changes.

Red LED is ON, not flashing

- There is an internal failure in the LMLS-400 sensor. Try unplugging the sensor from the DLM network, then plug it back in and wait for ten seconds. If the red LED comes back on, and is not flashing, the sensor is defective and must be replaced.

Red LED is flashing ON for three seconds, OFF for one second (repeating)

- The LMLS sensor is in **Control Mode <Disable>**. Use the LMCT-100 to change the Control Mode parameter to <Normal> to resume daylighting operation.

Blue LED is flashing

- If the blink is slow (one flash every four seconds), the photosensor is in an override condition, either due to an override from a wall switch or due to an automatic or manual commissioning operation. If the latter, complete the commissioning operation first; otherwise, use a wall switch to turn off the controlled loads to terminate the override.
- If the blink is faster (one flash every second), the photosensor is in Test Mode or Demo Mode. Test Mode will cancel automatically after five minutes. Alternatively, it can be turned off by selecting the Control Mode menu from the LMLS-400 main screen in the LMCT-100.

Reset to Factory Defaults

- If the photosensor has been moved from a different location, or its internal parameters are unknown and an LMCT-100 is not immediately available, it can be reset to factory defaults by pressing and holding the CONFIG button for 20 seconds (see SENSOR PUSHBUTTONS on page 3).

WARRANTY INFORMATION

Wattstopper warrants its products to be free of defects in materials and workmanship for a period of five (5) years. There are no obligations or liabilities on the part of Wattstopper for consequential damages arising out of, or in connection with, the use or performance of this product or other indirect damages with respect to loss of property, revenue or profit, or cost of removal, installation or reinstallation.

INFORMATIONS RELATIVES À LA GARANTIE

Wattstopper garantit que ses produits sont exempts de défauts de matériaux et de fabrication pour une période de cinq (5) ans. Wattstopper ne peut être tenu responsable de tout dommage consécutif causé par ou lié à l'utilisation ou à la performance de ce produit ou tout autre dommage indirect lié à la perte de propriété, de revenus, ou de profits, ou aux coûts d'enlèvement, d'installation ou de réinstallation.

INFORMACIÓN DE LA GARANTÍA

Wattstopper garantiza que sus productos están libres de defectos en materiales y mano de obra por un período de cinco (5) años. No existen obligaciones ni responsabilidades por parte de Wattstopper por daños consecuentes que se deriven o estén relacionados con el uso o el rendimiento de este producto u otros daños indirectos con respecto a la pérdida de propiedad, renta o ganancias, o al costo de extracción, instalación o reinstalación.
