

# Rigmaster™ LED Series Luminaires

Standard or with Emergency Battery Backup

Hazardous Locations

NEC/CEC: Class I, Division 2, Groups A, B, C, D | Class II, Division 1, Groups E, F, G | Class II, Division 2, Groups F, G | Class III | Class I, Zone 2, Group IIC | Class II, Zone 20 and 21, Group IIIC | Type 3R, 4, 4X | IP66 | IK10 | Simultaneous Exposure | Suitable for Use in Wet Locations | Marine Outside Type (Salt Water) Ⓛ

Notable: American Bureau of Shipping (ABS) Certified | International Dark Sky (IDA) Approved | 10G Vibration

## Applications

- For use in locations where:
  - Flammable gases and dusts may be present
  - A high degree of corrosion resistance is required
  - Protection against dirt, water and moisture is necessary
- Typical industries include:
  - Drilling rigs
  - Oil refineries
  - Petrochemical facilities
  - Waste and sewer treatment
  - Underground tunnels
  - Analyzer houses
  - Cooling towers
  - Grain elevators
  - Coal and metal manufacturing
  - Flour and feed mills
  - Hydrogen and Biofuels plants
  - LNG (Liquid Natural Gas) plants



RM\*2 with Small Swivel Bracket



RM\*4 with Large Swivel Bracket

## Features

- All Models:
  - Lightweight design makes mounting and installation easy.
  - Low fixture profile allows installation in compact spaces.
  - Two sizes and output options deliver up to 7600 lumens.

Nominal Lumens Ⓛ	Fluorescent Equivalent	Replacement Lamp Type	Model
4300	2 x 32W	T8	RM*2
7600	3 x 32W	T8	RM*4

- Precision engineered clear polycarbonate lens offers wide light distribution for greater area coverage.
- Choice of color temperature (CCT): 5000K cool white, 4000K neutral white or 3000K warm white with minimum 80 CRI.
- Field replaceable lens and LED driver.
- Diverse mounting bracket options allow for mounting in any location and retrofitting third party fixtures.
- For ease of retrofitting, mounting brackets accommodate most bolt patterns for Crouse-Hinds™ ±, Dialight™\* and other manufacturers. See *Mounting Brackets*.
- Wirenuts and screw terminal block ③ option for added flexibility.
- Hinged wire compartment cover is secured with captive screws for safety and convenience.
- Loop in/out wiring capability for inter connecting fixtures
- Standard screw-type terminal block can accept UL/CSA 22-12 AWG wire.
- 5 casted points for secondary safety retention.
- Heavy duty, high temperature silicone gaskets.
- Standard 6 kV/3 kA surge protection.
- Fixture position locking mechanism provides ease and consistency of aiming.
- Rugged housing with superior thermal design translates to long luminaire life.

### — Reported L70:

+25 °C (+77 °F)	Reported	> 60000
	Calculated	> 200000
+65 °C (+149 °F)	Reported	> 60000
	Calculated	> 200000

— Photometric data and electronic drawings available upon request.

- Standard Model:
  - Ambient Temperature: -40 °C to +65 °C (-40 °F to +149 °F).
- Emergency Battery Backup Model:
  - Emergency version is suitable for heights up to 14 feet.
  - Ambient Temperature: -20 °C to +55 °C (-4 °F to +131 °F).
  - Suitable for heights up to 4.27 m (14 ft).
  - Field replaceable battery pack and battery management module (BMM)

## Warranty Ⓛ

- 10 year standard warranty.

## Options

- All Models:
  - Yoke brackets can be factory installed or purchased separately.
  - Pendant mount kits ④ can be purchased separately.
  - Safety cable can be purchased separately or configured as an add on option to be shipped with the LED fixture.
  - Available with 3/4" or 1/2" NPT threaded hubs.
  - Clear or diffused polycarbonate lens.
  - Wirenuts or screw terminal blocks ③ available.
  - For custom paint colors, contact your Appleton Sales Representative. Minimum quantity applies.
- Emergency Battery Backup Model:
  - 90 or 180 minutes of emergency battery back up available.

Ⓛ Marine Outside Type (Salt Water) is applicable to standard (non emergency) fixtures only.

Ⓛ Nominal lumen value for 5000K, clear Lens. Detailed lumen information is provided in the "Lumen Output (Efficacy)" tables.

③ Terminal block option available for BU voltage configuration only.

④ Pendant mount kit option is not available with Type 3R, 4, 4X, IP66, and Marine Outside Type (Salt Water) ratings.

± Crouse-Hinds is a registered trademark of Cooper Industries, Inc., a wholly owned subsidiary of the Eaton Corporation plc.

\* Dialight is a registered trademark of Dialight.

Ⓛ For warranty details go to [www.appleton.emerson.com](http://www.appleton.emerson.com).

# Rigmaster™ LED Series Luminaires

Standard or with Emergency Battery Backup

Hazardous Locations

NEC/CEC: Class I, Division 2, Groups A, B, C, D | Class II, Division 1, Groups E, F, G | Class II, Division 2, Groups F, G | Class III | Class I, Zone 2, Group IIC | Class II, Zone 20 and 21, Group IIIC | Type 3R, 4, 4X | IP66 | IK10 | Simultaneous Exposure | Suitable for Use in Wet Locations | Marine Outside Type (Salt Water) ①  
Notable: American Bureau of Shipping (ABS) Certified | International Dark Sky (IDA) Approved | 10G Vibration

## Standard Materials

- Housing: copperfree (4/10 of 1% max.) aluminum
- Lens: thermal shock- and impact-resistant polycarbonate lens
- Gasket: silicone rubber
- Bolts: stainless steel
- Close up plugs: (3) aluminum provided
- Mounting brackets: zinc plated steel

## Standard Finishes

- Housing: gray epoxy powder coat finish, electrostatically applied for complete uniform protection

## NEC/CEC Certifications and Compliances

- All Models:
  - UL Standard: UL 844; UL 1598; UL 50E; UL 8750
  - CSA Standard: C22.2 No. 0; C22.2 No. 94.2; C22.2 No. 137; C22.2 No. 250.0
  - NEMA/ANSI/IEC Standards: 60529
- Standard Model:
  - UL Standard: UL 1598A
  - cCSAus: 164460, Certificate Number: 70212106
  - Vibration Rating:
    - Small and large swivel brackets: 10G, 2 hours, 3 axis at first mode resonant frequency.
    - Low profile bracket : 5G, 2 hours, 3 axis at first mode resonant frequency.
- Emergency Battery Backup Model:
  - UL Standard: UL 924
  - CSA Standard: C22.2 No. 141
  - cCSAus: 164460, Certificate Number: 70218504
  - Vibration Rating: 5G, 2 hours, 3 axis at first mode resonant frequency

## ABS Certifications

- IRM/RM: 19-HS1867599-PDA

## International Dark-Sky Association

- IDA Dark Sky Approved when ordering RM[A/B/L/N][2/4][1/2]W[D/P]L [BU/BH][N/H/E]G[W/T][Blank/1/2] with [RMPENDKIT/RMHPENDKIT] (3000K CCT). ②

## DesignLights™ Consortium

- Check DLC QPL for current list of products.

## Related Products

- Industrial Rigmaster LED Series Luminaires
- Explosionproof Rigmaster LED Series Luminaires

① Marine Outside Type (Salt Water) is applicable to standard (non emergency) fixtures only.

② Pendant mount kit option is not available with Type 3R, 4, 4X, IP66, and Marine Outside Type (Salt Water) ratings.

# Rigmaster™ LED Series Luminaires

Standard or with Emergency Battery Backup

Hazardous Locations

NEC/CEC: Class I, Division 2, Groups A, B, C, D | Class II, Division 1, Groups E, F, G | Class II, Division 2, Groups F, G | Class III | Class I, Zone 2, Group IIC | Class II, Zone 20 and 21, Group IIIC | Type 3R, 4, 4X | IP66 | IK10 | Simultaneous Exposure | Suitable for Use in Wet Locations | Marine Outside Type (Salt Water) ①  
 Notable: American Bureau of Shipping (ABS) Certified | International Dark Sky (IDA) Approved | 10G Vibration

## Illustrated Features — All Models

### Flexibility and Modular Design



**Hinged wirebox cover with captive screws:** Allows hassle free installation in challenging conditions and prevents accidental disengagement to enhance workplace safety.



**Light where you need it:** Notched position locking mechanism enables fixture to be aimed consistently.

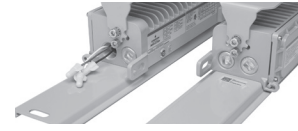

**Facilitates plug n play installation and decreases installation time:** Two NPT hubs on each end for through wiring. Leads are placed outside the wiring compartment allowing installer to bypass the screw cover.

Choose from **three color temperatures** (CCT): 3000K, 4000K, and 5000K.

**Standard linear light distribution pattern:** wide distribution maximizes spread and work plane brightness to optimize number of luminaires needed.

### Configurable Options



**Yoke Mounting Brackets ③④:** Ability to mount using one of three distinctly designed brackets to best suit your installation needs. All brackets can be factory installed to save time in the field or purchased separately.

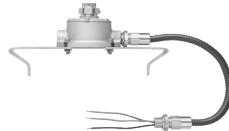

**Pendant Mounting Kits ④⑤:** The pendant mount kits consist of Appleton GRF Outlet Box with a built in union cover as well as the necessary mounting and wiring accessories. For ease of installation and added flexibility, it is field installable and purchased separately.



**Clear or Diffused Polycarbonate Lens:** Select a clear or diffused polycarbonate lens for the optimal level of work plane brightness and visual comfort. These lenses are field interchangeable for convenience and flexibility.

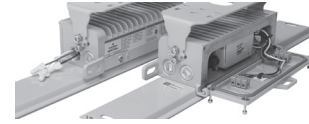

**Wirenuts or Screw Terminal Blocks ①②:** For ease of field installation, choose between wirenuts and screw terminal blocks ④ for 120-277 Vac configured models. Terminal blocks support UL/CSA 22 to 12 AWG wire.

### Safety Features

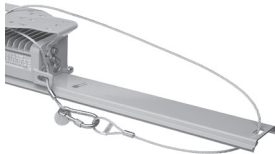

**Retention Points:** Five points for secondary retention provide protection against in-field vibration.



**Safety cables ③:** Can be purchased separately or included with fixture to reduce ordering and receiving complexity.

① Applicable to standard (non emergency) fixtures only.

② Terminal block option is available for standard unit, BU voltage configuration only.

③ Brackets and safety cables can be ordered separately or included with fixture. See Ordering Table for more information.

④ Mounting Brackets compatible with standard and emergency versions are not the same. Please refer to mounting bracket details for more information.

⑤ Pendant mount kit option is not available with Type 3R, 4, 4X, IP66, and Marine Outside Type (Salt Water) ratings.

# Rigmaster™ LED Series Luminaires

Standard or with Emergency Battery Backup

Hazardous Locations

NEC/CEC: Class I, Division 2, Groups A, B, C, D | Class II, Division 1, Groups E, F, G | Class II, Division 2, Groups F, G | Class III | Class I, Zone 2, Group IIC | Class II, Zone 20 and 21, Group IIIC |

Type 3R, 4, 4X | IP66 | IK10 | Simultaneous Exposure | Suitable for Use in Wet Locations | Marine Outside Type (Salt Water) ①

Notable: American Bureau of Shipping (ABS) Certified | International Dark Sky (IDA) Approved | 10G Vibration

## Order Using Catalog Numbering Guide — Rigmaster™ LED Series Luminaires

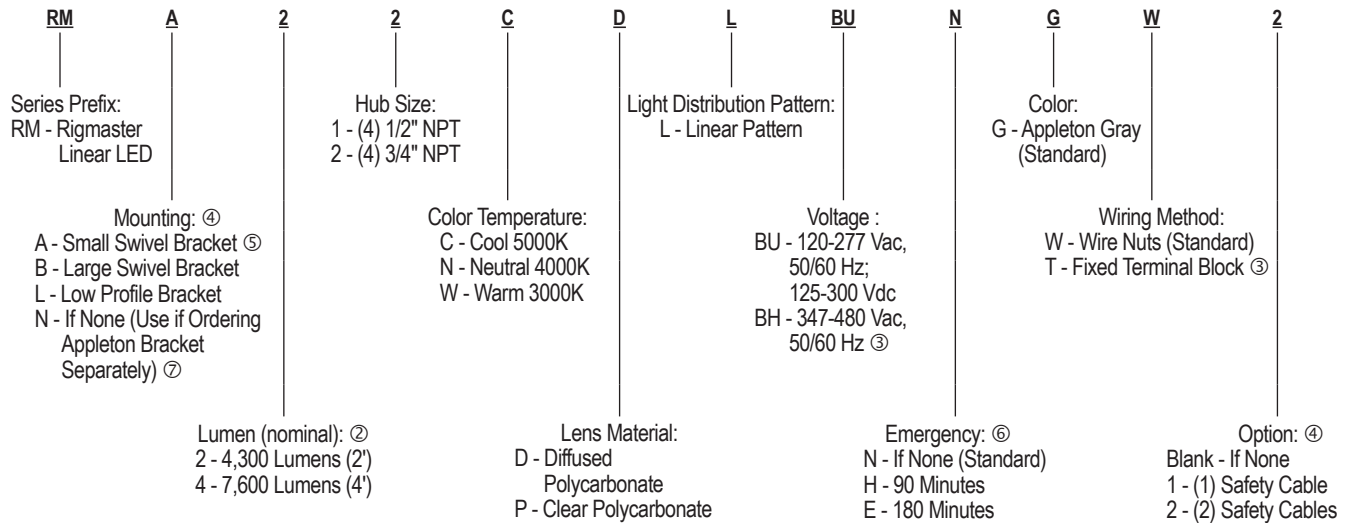

### Lumen Output (Efficacy) — Standard Model — Standard Mode ③

Model	Fluorescent Equivalency	Light Distribution Pattern	CCT (Correlated Color Temperature)	CRI (Color Rendering Index)	Lumen Output	Efficacy (lm/W)	CCT	CRI	Lumen Output	Efficacy (lm/W)	CCT	CRI	Lumen Output	Efficacy (lm/W)
<b>Clear Polycarbonate Lens</b>														
RM*2	2 x 32W	Linear	3000K	>80	4160	126	4000K	>80	4230	128	5000K	>80	4390	133
RM*4	3 x 32W	Linear	3000K	>80	7250	132	4000K	>80	7370	134	5000K	>80	7650	139
<b>Diffused Polycarbonate Lens</b>														
RM*2	2 x 32W	Linear	3000K	>80	3890	118	4000K	>80	3950	120	5000K	>80	4100	124
RM*4	3 x 32W	Linear	3000K	>80	6770	125	4000K	>80	6870	125	5000K	>80	7130	130

### Lumen Output (Efficacy) — Emergency Model — Emergency Mode ⑥⑧

Model	Emergency Duration in Minutes	Light Distribution Pattern	CCT (Correlated Color Temperature)	CRI (Color Rendering Index)	Lumen Output	Efficacy (lm/W)	CCT	CRI	Lumen Output	Efficacy (lm/W)	CCT	CRI	Lumen Output	Efficacy (lm/W)
<b>Clear Polycarbonate Lens</b>														
RM*2/RM*4	90	Linear	3000K	>80	1200	N/A	4000K	>80	1260	N/A	5000K	>80	1350	N/A
	180	Linear	3000K	>80	720	N/A	4000K	>80	760	N/A	5000K	>80	800	N/A
<b>Diffused Polycarbonate Lens</b>														
RM*2/RM*4	90	Linear	3000K	>80	1080	N/A	4000K	>80	1090	N/A	5000K	>80	1130	N/A
	180	Linear	3000K	>80	670	N/A	4000K	>80	680	N/A	5000K	>80	700	N/A

① Marine Outside Type (Salt Water) is applicable to standard (non emergency) fixtures only.

② For lumen output information, see Lumen Output (Efficacy) Table.

③ Terminal block option available for standard unit, BU voltage configuration only.

④ Brackets and safety cables can be ordered separately or included with fixture. See Mounting Brackets Table for more information.

⑤ Mounting option A is not available with emergency version.

⑥ Emergency battery back up version is only available with BU voltage configuration for 120-277 Vac operation.

⑦ See Mounting Brackets table for details.

⑧ All lumen values are typical (tolerance +/- 10%).

# Rigmaster™ LED Series Luminaires

Standard or with Emergency Battery Backup

Hazardous Locations

NEC/CEC: Class I, Division 2, Groups A, B, C, D | Class II, Division 1, Groups E, F, G | Class II, Division 2, Groups F, G | Class III | Class I, Zone 2, Group IIC | Class II, Zone 20 and 21, Group IIIC | Type 3R, 4, 4X | IP66 | IK10 | Simultaneous Exposure | Suitable for Use in Wet Locations | Marine Outside Type (Salt Water) ①

Notable: American Bureau of Shipping (ABS) Certified | International Dark Sky (IDA) Approved | 10G Vibration

## Electrical Specifications ②

Model	Voltage	Input Power (Watts)	Input Current (Amps)	Power Factor (PF)	Total Harmonic Distortion (THD)
<b>Standard Model</b>					
RM*2	120 Vac	33	0.28	>0.9	<20
	277 Vac	33	0.12	>0.9	<20
	125 Vdc	33	0.27	NA	NA
	300 Vdc	33	0.11	NA	NA
	347 Vac	36	0.11	>0.9	<20
	480 Vac	36	0.08	>0.9	<20
RM*4	120 Vac	55	0.47	>0.9	<20
	277 Vac	55	0.20	>0.9	<20
	125 Vdc	55	0.44	NA	NA
	300 Vdc	55	0.18	NA	NA
	347 Vac	56	0.16	>0.9	<20
	480 Vac	56	0.12	>0.9	<20
<b>Emergency Model</b>					
RM*2	120 Vac	39	0.35	>0.9	<20
	277 Vac	39	0.15	>0.9	<20
RM*4	120 Vac	60	0.57	>0.9	<20
	277 Vac	60	0.20	>0.9	<20

① Marine Outside Type (Salt Water) is applicable to standard (non emergency) fixtures only.

② All values are typical (tolerance +/-10%).

# Rigmaster™ LED Series Luminaires

Standard or with Emergency Battery Backup  
Hazardous Locations

NEC/CEC: Class I, Division 2, Groups A, B, C, D | Class II, Division 1, Groups E, F, G | Class II, Division 2, Groups F, G | Class III | Class I, Zone 2, Group IIC | Class II, Zone 20 and 21, Group IIIC | Type 3R, 4, 4X | IP66 | IK10 | Simultaneous Exposure | Suitable for Use in Wet Locations | Marine Outside Type (Salt Water) ①  
 Notable: American Bureau of Shipping (ABS) Certified | International Dark Sky (IDA) Approved | 10G Vibration

## NEC/CEC Temperature Codes

Model	Ambient Temperature °C (°F)	Supply wire Temperature °C (°F)	Class I, Division 2, Groups A, B, C, D	Class I, Zone 2, Group IIC	Class II, Division 1, Groups E, F, G	Zone 20, Group IIIC	Class I, Division 2 and Class II, Division 1
<b>Standard Model ②</b>							
RM*2	+40 (+104)		T6	T6	T6	T6	T5
	+55 (+131)	+90 (+194)	T5	T5	T5	T5	T4A
	+65 (+149)		T4A	T4	T4A	T4	T4A
RM*4	+40 (+104)		T5	T5	T6	T6	T5
	+55 (+131)	+90 (+194)	T4A	T4	T5	T5	T4A
	+65 (+149)		T4A	T4	T4A	T4	T4A
<b>Emergency Model ③</b>							
RM*2	+40 (+104)	+90 (+194)	T5	T5	T5	T5	T4A
	+55 (+131)		T5	T5	T4A	T4	T4A
RM*4	+40 (+104)	+90 (+194)	T5	T5	T5	T5	T4A
	+55 (+131)		T5	T5	T4A	T4	T4A

## NEC/CEC — “T” Numbers Represent the Maximum Internal Temperature or Maximum Surface Temperature ④⑤

“T” #	T1	350	325	T2	T2A	T2B	T2C	T2D	T3	T3A	T3B	T3C	T4	T4A	T5	T6
Temp. Range °C (°F)	+351 to +450 (+664 to +842)	+326 to +350 (+619 to +662)	+301 to +325 (+574 to +617)	+281 to +300 (+538 to +572)	+261 to +280 (+502 to +536)	+231 to +260 (+448 to +500)	+216 to +230 (+421 to +446)	+201 to +215 (+394 to +419)	+181 to +200 (+358 to +392)	+166 to +180 (+331 to +356)	+161 to +165 (+322 to +329)	+136 to +160 (+277 to +320)	+121 to +135 (+250 to +275)	+101 to +120 (+214 to +248)	+86 to +100 (+187 to +212)	+85 (+185)

① Marine Outside Type (Salt Water) is applicable to standard (non emergency) fixtures only.

② Standard Models Ambient Temperature Range: -40 °C to +65 °C (-40 °F to +149 °F).

③ Emergency Models Ambient Temperature Range: -20 °C to +55 °C (-4 °F to +131 °F).

④ T numbers represent the maximum internal temperature for Class I, Division 1 and Class II, Division 1 locations designated by the NEC.

⑤ T numbers represent the maximum surface temperature under a dust blanket for Class II, Division 2 as designated by the NEC.

# Rigmaster™ LED Series Luminaires

With Emergency Battery Backup  
Hazardous Locations

NEC/CEC: Class I, Division 2, Groups A, B, C, D | Class II, Division 1, Groups E, F, G | Class II, Division 2, Groups F, G | Class III | Class I, Zone 2, Group IIC | Class II, Zone 20 and 21, Group IIIC | Type 3R, 4, 4X | IP66 | IK10 | Simultaneous Exposure | Suitable for Use in Wet Locations | Marine Outside Type (Salt Water) ①  
Notable: American Bureau of Shipping (ABS) Certified | International Dark Sky (IDA) Approved | 10G Vibration

## Automatic Testing System (ATS) — Emergency Battery Backup Model — Functionality ②

Functional	Full Duration
Starts within 24 to 45 hours after the initial powerup of the module	Starts within 5 to 26 days after the initial power of the module
Occurs every 14 days after the initial aforementioned functional test	Occurs every 364 days after the initial aforementioned functional test
Lasts for 30 seconds	Lasts for the full duration of the rated emergency period

At the completion of functional and full duration tests, LED indicator will display the status of the emergency luminaire when AC is present

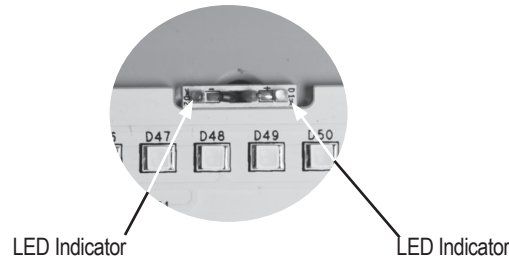

### LED Signals

Indicator Color	Timing	Description
Green	1 sec ON: 1 sec OFF	Normal charging ok, Battery not yet fully charged, No fault detected, Testing ok
Green	0.25 sec ON: 0.25 sec OFF	Functional / Duration Self-Test on-going
Green	Steady ON	Charging ok, Battery fully charged, No fault detected, Testing ok
Red	1 sec ON: 1 sec OFF	Fault condition. Installation issue. Battery is reverse, not connected or shorted. Functional test failure, full duration test failure
LED Indicators OFF, LED Array ON	LED Indicator Lights (Red and Green) OFF	No AC, Emergency mode ON

① Marine Outside Type (Salt Water) is applicable to standard (non emergency) fixtures only.



② Applicable only for Emergency model.

# Rigmaster™ LED Series Luminaires



Standard or with Emergency Battery Backup  
Hazardous Locations

NEC/CEC: Class I, Division 2, Groups A, B, C, D | Class II, Division 1, Groups E, F, G | Class II, Division 2, Groups F, G | Class III | Class I, Zone 2, Group IIC | Class II, Zone 20 and 21, Group IIIC | Type 3R, 4, 4X | IP66 | IK10 | Simultaneous Exposure | Suitable for Use in Wet Locations | Marine Outside Type (Salt Water) ①  
Notable: American Bureau of Shipping (ABS) Certified | International Dark Sky (IDA) Approved | 10G Vibration

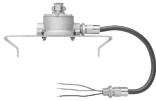
## Mounting Brackets

	Description	Weight in kg (lbs)	Catalog Number
<b>Standard Model</b>			
	Small Swivel Bracket	0.74 (1.7)	RMSSB
	Large Swivel Bracket	1.08 (2.4)	RMLSB
	Low Profile Bracket	0.80 (1.8)	RMLPB
	Pendant Mount and Top Wire Entry Kit	4.54 (10.0)	RMPENDKIT ②

## Emergency Model

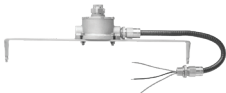
	Emergency Swivel Bracket	2.0 (4.4)	RMHLSB
	Emergency Low Profile Bracket	1.9 (4.1)	RMHLPB
	Pendant Mount and Top Wire Entry Kit	5.4 (12.0)	RMHPENDKIT ②

## Bracket Mounting Angles

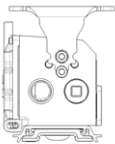
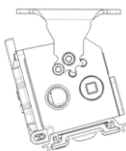
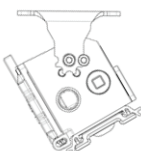
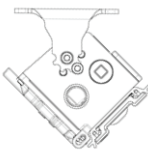
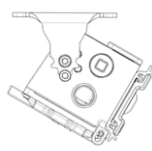
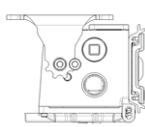
0°	15°	30°	45°	60°	90°
					

① Marine Outside Type (Salt Water) is applicable to standard (non emergency) fixtures only.

② Pendant mount kit option is not available with Type 3R, 4, 4X, IP66, and Marine Outside Type (Salt Water) ratings.

# Rigmaster™ LED Series Luminaires

Standard or with Emergency Battery Backup

Hazardous Locations

NEC/CEC: Class I, Division 2, Groups A, B, C, D | Class II, Division 1, Groups E, F, G | Class II, Division 2, Groups F, G | Class III | Class I, Zone 2, Group IIC | Class II, Zone 20 and 21, Group IIIC | Type 3R, 4, 4X | IP66 | IK10 | Simultaneous Exposure | Suitable for Use in Wet Locations | Marine Outside Type (Salt Water) ①

Notable: American Bureau of Shipping (ABS) Certified | International Dark Sky (IDA) Approved | 10G Vibration

## Mounting Bracket Selection Guide ②

For customers trying to retrofit an existing fixture and match bolt patterns, use the table below as a guide to select the best bracket to suit your needs

Other Manufacturer	Other Manufacturer Part Number	Description	Catalog Number	Description	Catalog Number	Description	Catalog Number
<b>Standard Model</b>							
Crouse Hinds™ <sup>+</sup>	DP1057MTK	—	—	Large Swivel Bracket	<b>RMLSB</b>	Low Profile Bracket	<b>RMLPB</b>
Dialight™ <sup>✦</sup>	LTXW4	Small Swivel Bracket	<b>RMSSB</b>	Large Swivel Bracket	<b>RMLSB</b>	—	—
	LTXW4LP	—	—	Large Swivel Bracket	<b>RMLSB</b>	Low Profile Bracket	<b>RMLPB</b>
AZZ™* Rig-A-Lite™*	53050	Small Swivel Bracket	<b>RMSSB</b>	Large Swivel Bracket	<b>RMLSB</b>	—	—
<b>Emergency Model</b>							
Crouse Hinds™ <sup>+</sup>	DP1057MTK	—	—	Emergency Swivel Bracket	<b>RMHLSB</b>	Emergency Low Profile Bracket	<b>RMHLPB</b>
	LTXW4	—	—	Emergency Swivel Bracket	<b>RMHLSB</b>	Emergency Low Profile Bracket	<b>RMHLPB</b>
Dialight™ <sup>✦</sup>	LSXW5	—	—	Emergency Swivel Bracket	<b>RMHLSB</b>	Emergency Low Profile Bracket	<b>RMHLPB</b>
	LSXW4	—	—	Emergency Swivel Bracket	<b>RMHLSB</b>	Emergency Low Profile Bracket	<b>RMHLPB</b>
AZZ™* Rig-A-Lite™*	53050	—	—	Emergency Swivel Bracket	<b>RMHLSB</b>	Emergency Low Profile Bracket	<b>RMHLPB</b>

① Marine Outside Type (Salt Water) is applicable to standard (non emergency) fixtures only.

② The above information is strictly for guidance purposes and does not guarantee compatibility and fit. Please carefully review bolt patterns on each bracket to ensure it meets your needs

<sup>+</sup> Crouse-Hinds is a registered trademark of Cooper Industries, Inc., a wholly owned subsidiary of the Eaton Corporation plc.

<sup>✦</sup> Dialight is a registered trademark of Dialight.



\* AZZ and Rig-A-Lite are registered trademarks of AZZ.

# Rigmaster™ LED Series Luminaires

Standard or with Emergency Battery Backup  
Hazardous Locations

NEC/CEC: Class I, Division 2, Groups A, B, C, D | Class II, Division 1, Groups E, F, G | Class II, Division 2, Groups F, G | Class III | Class I, Zone 2, Group IIC | Class II, Zone 20 and 21, Group IIIC | Type 3R, 4, 4X | IP66 | IK10 | Simultaneous Exposure | Suitable for Use in Wet Locations | Marine Outside Type (Salt Water) ①  
Notable: American Bureau of Shipping (ABS) Certified | International Dark Sky (IDA) Approved | 10G Vibration

## Replacement Lenses — All Models

	Description	Model	Quantity Per Luminaire	Weight in kg (lbs)	Catalog Number
	Clear Polycarbonate Lens	RM*2	1	1.0 (2.2)	RMCL
		RM*4	2		
	Diffused Polycarbonate Lens	RM*2	1	1.0 (2.2)	RMDL
		RM*4	2		





## Replacement Drivers — All Models

	Model	Voltage	Driver Wattage	Constant Current Settings	Catalog Number
	IRM*2	50W	BU	600mA	APM050C135UD060
	IRM*2	50W	BH	600mA	APM050C135HD060
	IRM*4	50W	BU	1040mA	APM050C135UD104
	IRM*4	50W	BH	1040mA	APM050C135HD104

## Accessories and Replacement Parts — Emergency Model

Description	Weight in kg (lbs)	Catalog Numbers
Replacement Battery — Management Module	1.0 (2.2)	BPMLLED
Replacement Battery Pack	0.7 (1.6)	BMMRM

## Mounting Accessories — All Models

Description	Weight in kg (lbs)	Catalog Numbers
 Wire Guard - 2 feet	0.4 (.88)	RMGUARD2
 Wire Guard - 4 feet	0.62 (1.36)	RMGUARD4
 Safety Cable — Stainless Steel	0.2 (0.4)	LEDSC
 Half clamp 316 stainless steel brackets for pole mounting (set of two) ②	• For 42 mm to 49 mm (1-1/4 to 1-1/2") pole	0.3 (0.7) FEHC49S ②
	• For 60 mm (2") pole	0.5 (1.2) FEHC60S ②
 Conduit clamp ③	• Zinc plated steel conduit hanger with swing bolts	0.03 (0.07) H75-SWB ③

## Alternate Beam Clamp Mounting Option — All Models

	Dimensions in Millimeters (Inches)					Max Load kg (lbs)	Weight per 100 kg (lbs)	Catalog Number
	A	B	C	D	E			
	52.3 (2.06)	50.8 (2.00)	35.1 (1.38)	25.4 (1.00)	3/8 - 16	340.00 (750.00)	37.65 (83.00)	RMBACKIT

① Marine Outside Type (Salt Water) is applicable to standard (non emergency) fixtures only.

② Additional hardware (not supplied) is required to use this accessory with the Rigmaster fixture and mounting bracket. Please use two M8 x 20 mm bolts, two M8 split lock washers and two M8 nuts. For additional details contact Appleton Technical Support.

③ For compatibility of other Appleton conduit clamps, contact Appleton Technical Support.

# Rigmaster™ LED Series Luminaires

## Standard

### Hazardous Locations

NEC/CEC: Class I, Division 2, Groups A, B, C, D | Class II, Division 1, Groups E, F, G | Class II, Division 2, Groups F, G | Class III | Class I, Zone 2, Group IIC | Class II, Zone 20 and 21, Group IIIC | Type 3R, 4, 4X | IP66 | IK10 | Simultaneous Exposure | Suitable for Use in Wet Locations | Marine Outside Type (Salt Water) ①  
 Notable: American Bureau of Shipping (ABS) Certified | International Dark Sky (IDA) Approved | 10G Vibration

## Fixture — Dimensions in Millimeters (Inches) — Standard Model

### RM\*2 - Standard

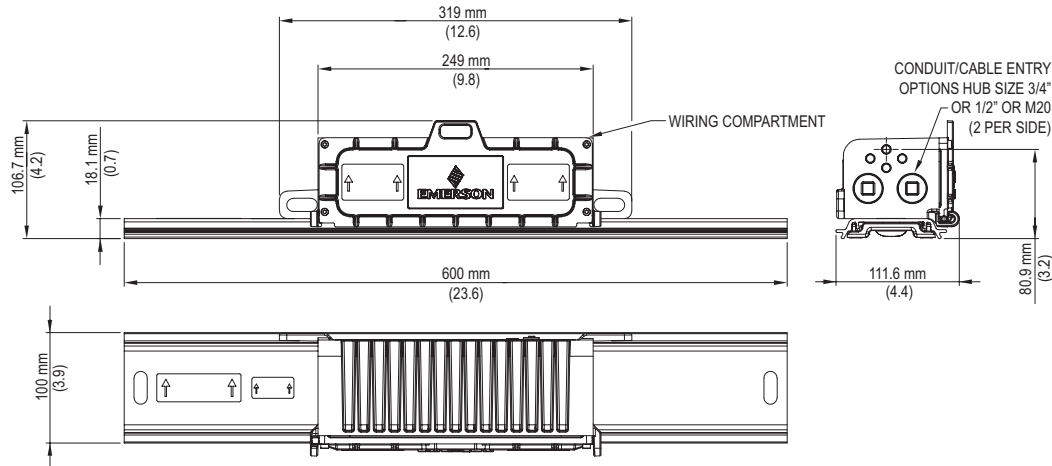

### RM\*4 - Standard

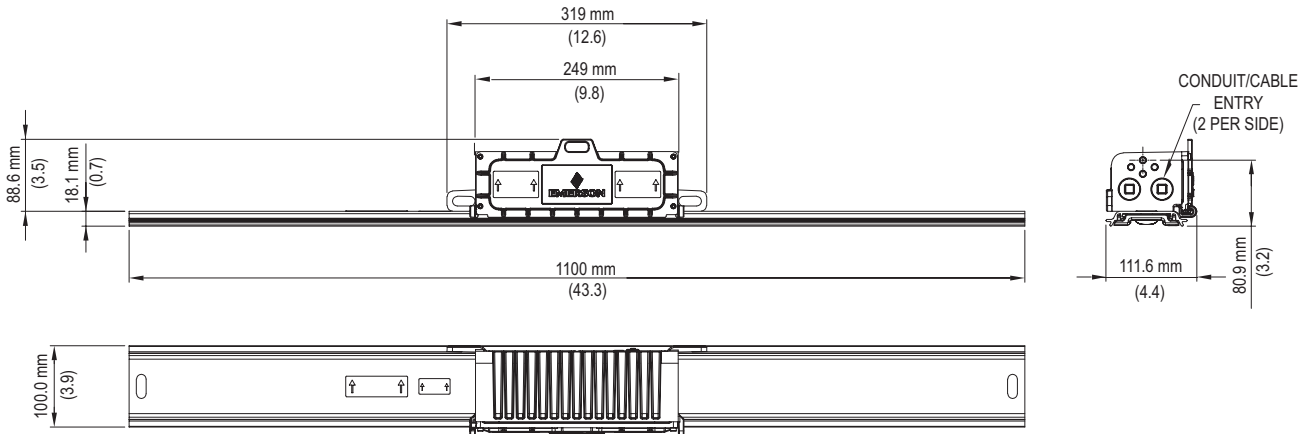

## Luminaire Specifications

Model	Weight in kg (lb) ②	Length in m (ft)
RM*2 — Standard	3.7 (8.2)	0.6 (2.0)
RM*4 — Standard	4.6 (10.1)	1.1 (3.6)

① Marine Outside Type (Salt Water) is applicable to standard (non emergency) fixtures only.

② Weight of brackets are not included. See Mounting Brackets Table for details.

# Rigmaster™ LED Series Luminaires

With Emergency Battery Backup  
Ordinary Locations

NEC/CEC: Class I, Division 2, Groups A, B, C, D | Class II, Division 1, Groups E, F, G | Class II, Division 2, Groups F, G | Class III | Class I, Zone 2, Group IIC | Class II, Zone 20 and 21, Group IIIC | Type 3R, 4, 4X | IP66 | IK10 | Simultaneous Exposure | Suitable for Use in Wet Locations | Marine Outside Type (Salt Water) ①  
Notable: American Bureau of Shipping (ABS) Certified | International Dark Sky (IDA) Approved | 10G Vibration

## Fixture — Dimensions in Millimeters (Inches) — Emergency Model

### RM\*2 - Emergency

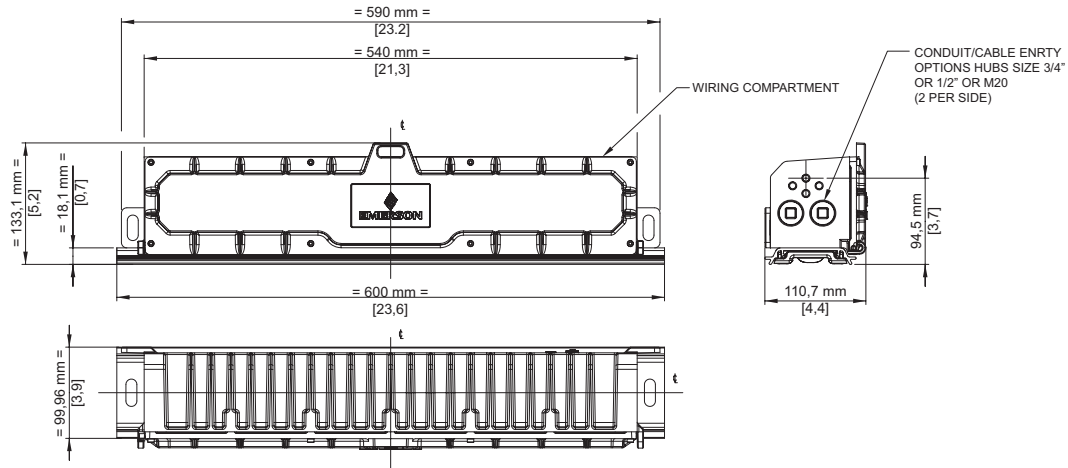

### RM\*4 - Emergency

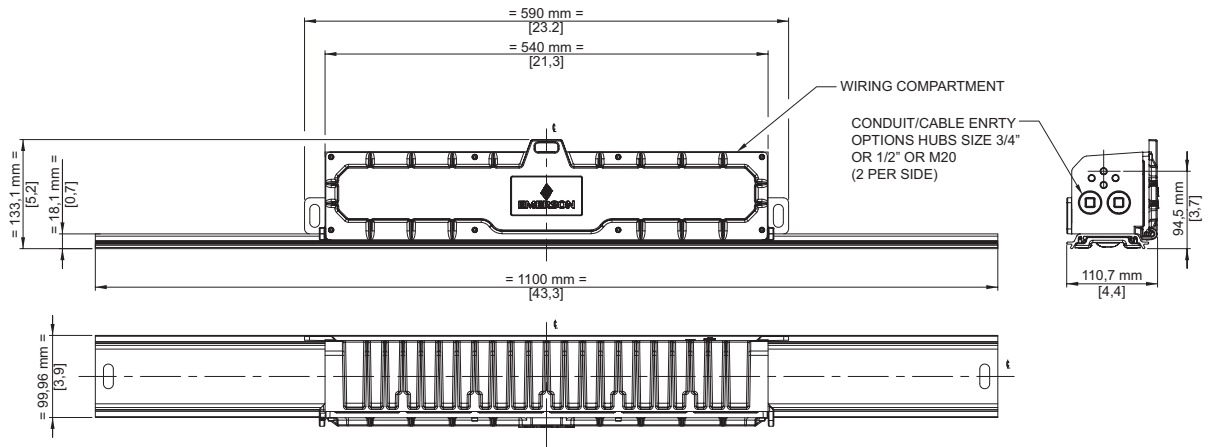

## Luminaire Specifications

Model	Weight in kg (lb) ②	Length in m (ft)
RM*2 — Emergency	7.6 (16.8)	0.6 (2.0)
RM*4 — Emergency	8.6 (19.0)	1.1 (3.6)

① Marine Outside Type (Salt Water) is applicable to standard (non emergency) fixtures only.

② Weight of brackets are not included. See Mounting Brackets Table for details.

# Rigmaster™ LED Series Luminaires

Standard or with Emergency Battery Backup  
Hazardous Locations

NEC/CEC: Class I, Division 2, Groups A, B, C, D | Class II, Division 1, Groups E, F, G | Class II, Division 2, Groups F, G | Class III | Class I, Zone 2, Group IIC | Class II, Zone 20 and 21, Group IIIC | Type 3R, 4, 4X | IP66 | IK10 | Simultaneous Exposure | Suitable for Use in Wet Locations | Marine Outside Type (Salt Water) ①  
Notable: American Bureau of Shipping (ABS) Certified | International Dark Sky (IDA) Approved | 10G Vibration

## Mounting Brackets — Dimensions in Millimeters (Inches) — Standard Model

### RMSSB - Small Swivel Bracket

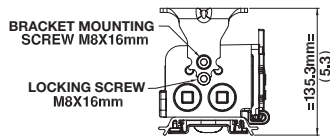
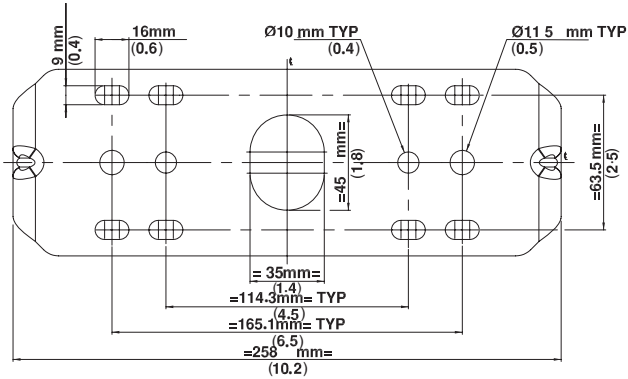

### RMLSB - Large Swivel Bracket

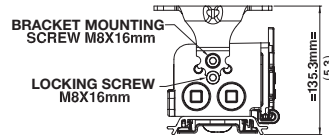
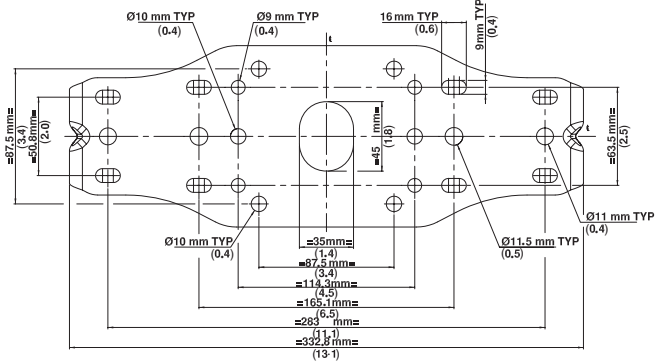

### RMLPB - Low Profile Bracket

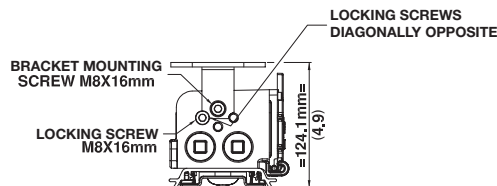
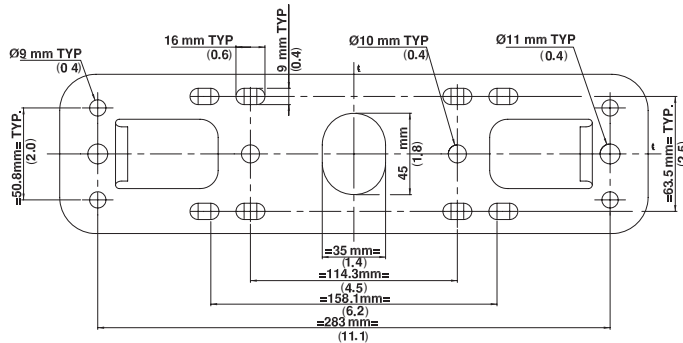

① Marine Outside Type (Salt Water) is applicable to standard (non emergency) fixtures only.

# Rigmaster™ LED Series Luminaires

Standard or with Emergency Battery Backup

Hazardous Locations

NEC/CEC: Class I, Division 2, Groups A, B, C, D | Class II, Division 1, Groups E, F, G | Class II, Division 2, Groups F, G | Class III | Class I, Zone 2, Group IIC | Class II, Zone 20 and 21, Group IIIC | Type 3R, 4, 4X | IP66 | IK10 | Simultaneous Exposure | Suitable for Use in Wet Locations | Marine Outside Type (Salt Water) ①  
Notable: American Bureau of Shipping (ABS) Certified | International Dark Sky (IDA) Approved | 10G Vibration

## Mounting Brackets — Dimensions in Millimeters (Inches) — Standard Model

### RMPENDKIT - Standard Pendant Mount Bracket

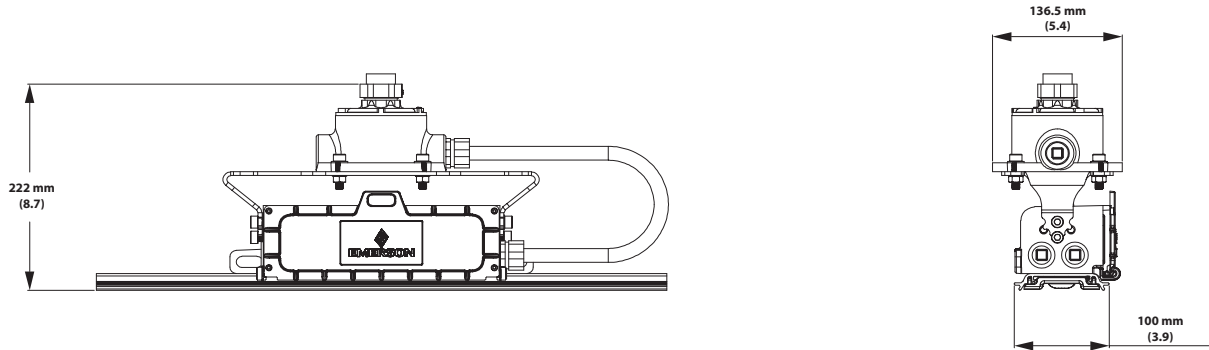

### RMHPENDKIT - Emergency Pendant Mount Bracket

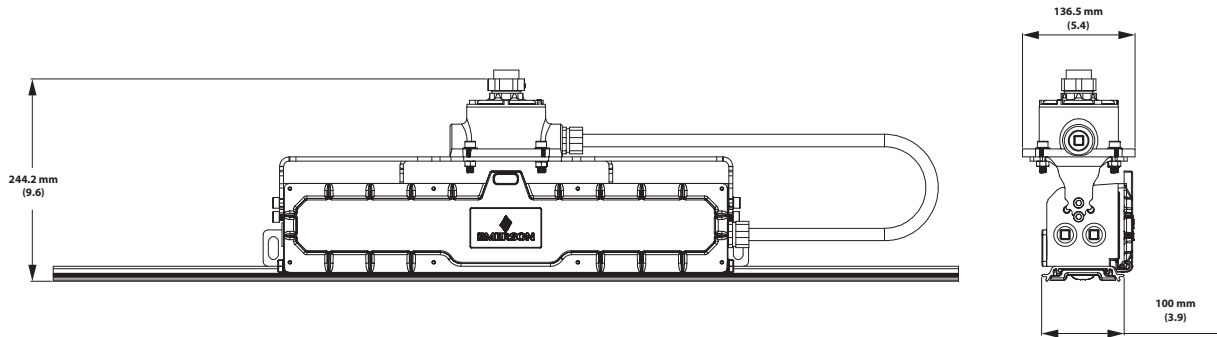

① Marine Outside Type (Salt Water) is applicable to standard (non emergency) fixtures only.

# Rigmaster™ LED Series Luminaires

Standard or with Emergency Battery Backup  
Hazardous Locations

NEC/CEC: Class I, Division 2, Groups A, B, C, D | Class II, Division 1, Groups E, F, G | Class II, Division 2, Groups F, G | Class III | Class I, Zone 2, Group IIC | Class II, Zone 20 and 21, Group IIIC | Type 3R, 4, 4X | IP66 | IK10 | Simultaneous Exposure | Suitable for Use in Wet Locations | Marine Outside Type (Salt Water) ①  
Notable: American Bureau of Shipping (ABS) Certified | International Dark Sky (IDA) Approved | 10G Vibration

## Mounting Brackets — Dimensions in Millimeters (Inches) — Emergency Model

### RMHLSB - Emergency Swivel Bracket

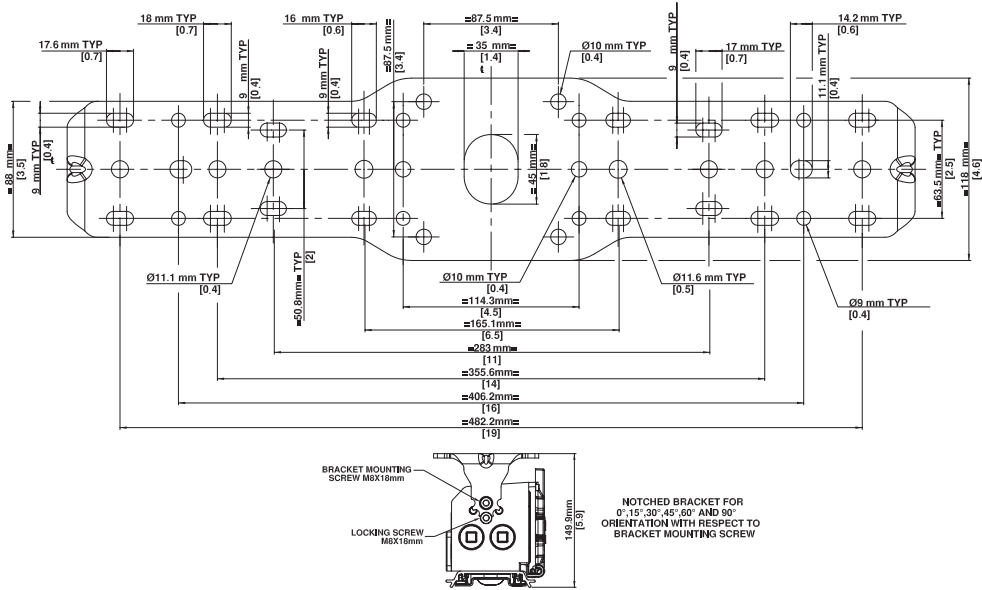

### RMHLPB - Emergency Low Profile Bracket

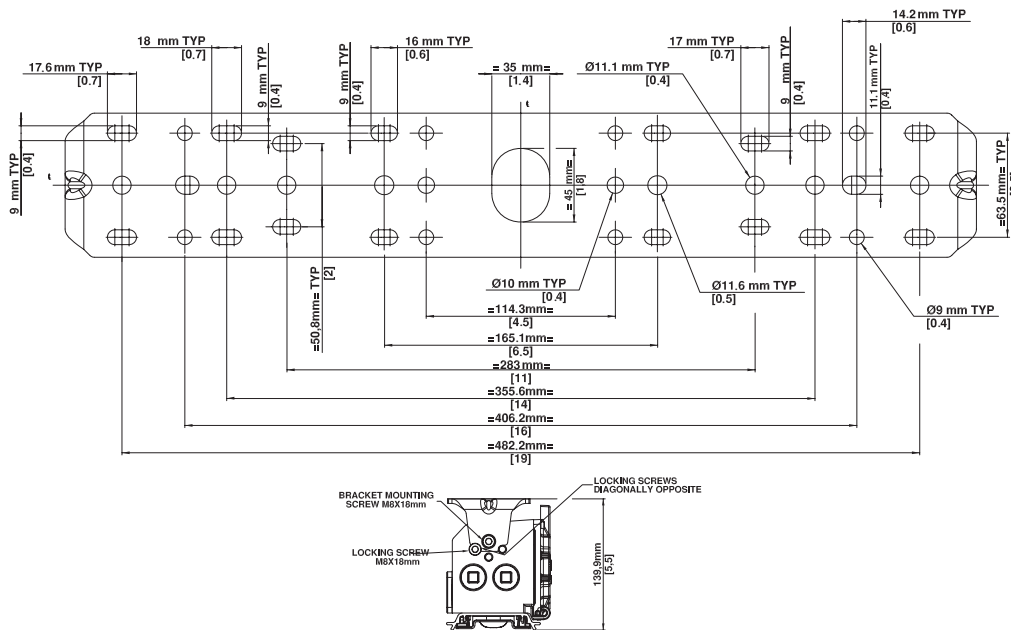

① Marine Outside Type (Salt Water) is applicable to standard (non emergency) fixtures only.

# Rigmaster™ LED Series Luminaires

Standard or with Emergency Battery Backup

Hazardous Locations

NEC/CEC: Class I, Division 2, Groups A, B, C, D | Class II, Division 1, Groups E, F, G | Class II, Division 2, Groups F, G | Class III | Class I, Zone 2, Group IIC | Class II, Zone 20 and 21, Group IIIC | Type 3R, 4, 4X | IP66 | IK10 | Simultaneous Exposure | Suitable for Use in Wet Locations | Marine Outside Type (Salt Water) Ⓢ  
 Notable: American Bureau of Shipping (ABS) Certified | International Dark Sky (IDA) Approved | 10G Vibration

## Photometric Data — DATA SHOWN IS ABSOLUTE

### 2ft, Clear Polycarbonate Lens, 5000K CCT

Luminaire Lumens 4,474.5

#### POLAR CANDELA DISTRIBUTION

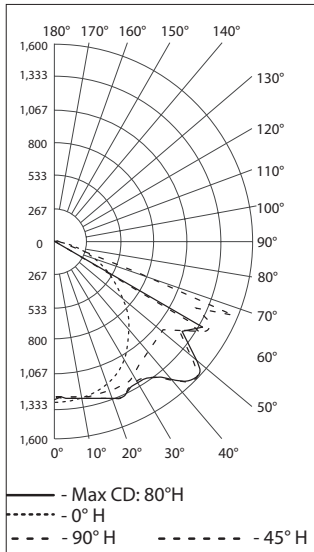

### 4ft, Clear Polycarbonate Lens, 5000K CCT

Luminaire Lumens 7,699.2

#### POLAR CANDELA DISTRIBUTION

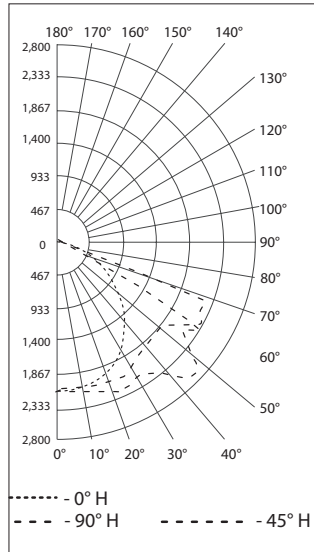

### 2ft, Diffused Polycarbonate Lens, 5000K CCT

Luminaire Lumens 4001.8

#### POLAR CANDELA DISTRIBUTION

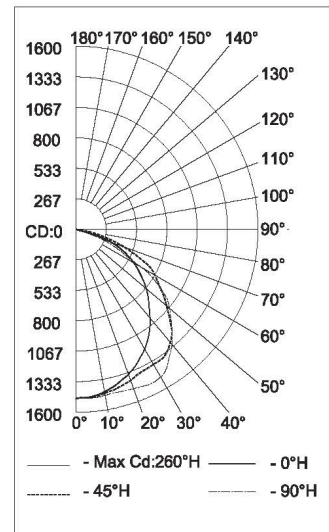

### 4ft, Diffused Polycarbonate Lens, 5000K CCT

Luminaire Lumens 6704.4

#### POLAR CANDELA DISTRIBUTION

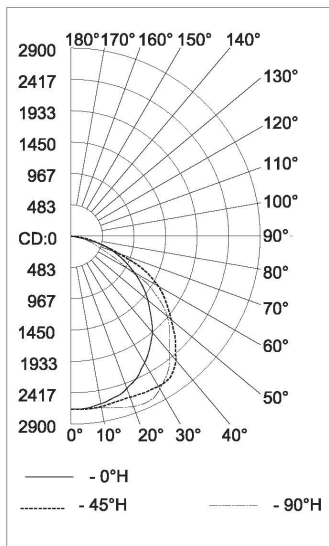

### 2ft Clear Polycarbonate Lens, 5000K CCT - Emergency Mode

Luminaire Lumens 1,364.9

#### POLAR CANDELA DISTRIBUTION

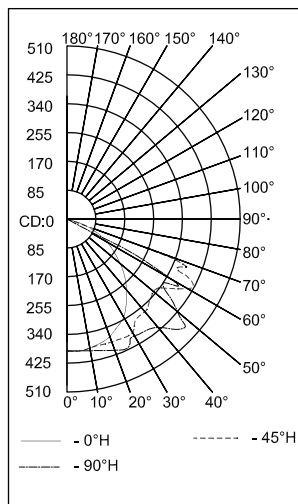

### 4ft Clear Polycarbonate Lens, 5000K CCT - Emergency Mode

Luminaire Lumens 1,360.2

#### POLAR CANDELA DISTRIBUTION

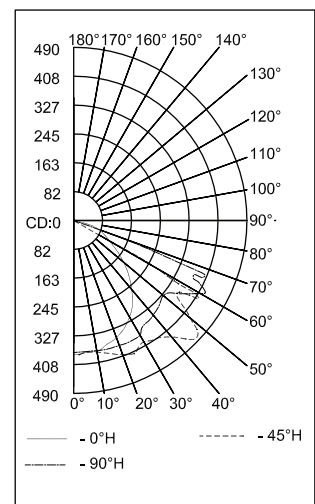

Ⓢ Marine Outside Type (Salt Water) is applicable to standard (non emergency) fixtures only.