



HGX LED 2RH ALO SWW2 120 PE DDB M2

HGX

A complete security floodlighting solution



HGX LED 2RH ALO SWW2 120 PIR DDB M2
*Wall mount only



HGX LED 3RH ALO SWW2 120 PE WH M2

Luminaire	Length (L)	Width (W)	Height (H)	Lamp head dia (A)	Back plate dia (B)	Back plate thickness (C)	Weight
HGX 2RH	4.41" (11.2cm)	7.56" (19.2cm)	4.25" (10.8cm)	2.4" (6.1cm)	4.25" (10.8cm)	1.38" (3.5cm)	1.15 lbs (0.52 kg)
HGX 3RH	5.12" (13cm)	7.72" (19.6cm)	4.53" (11.5cm)	2.4" (6.1cm)	4.53" (11.51cm)	2.13" (5.4cm)	1.77 lbs (0.8kg)
HGX 2SH	4.53" (11.5cm)	7.56" (19.2cm)	4.33" (11cm)	2.40" (6.1cm)	4.33" (11cm)	1.54" (3.9cm)	1.31 lbs (0.6kg)
HGX 2RH PIR	4.96" (12.6cm)	7.52" (19.1cm)	4.53" (11.5cm)	2.40" (6.1cm)	4.53" (11.5cm)	1.89" (4.8cm)	1.37lbs (0.62 kg)
HGX 2RH ALO	4.53" (11.51cm)	7.56" (19.2cm)	4.33" (11cm)	2.40" (6.1cm)	4.33" (11cm)	1.54" (3.9cm)	1.31lbs (0.6kg)

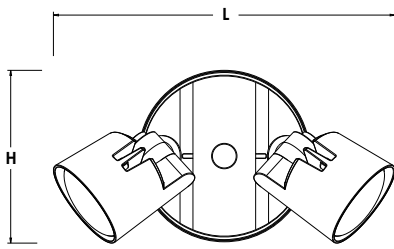

HGX 2RH & HGX 2RH ALO

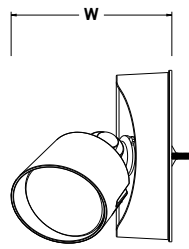

HGX 2SH

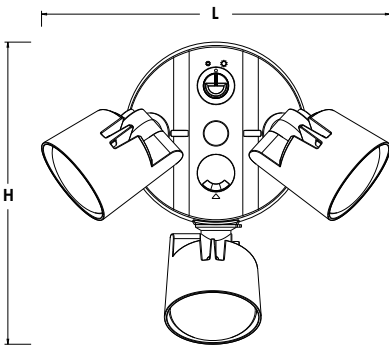
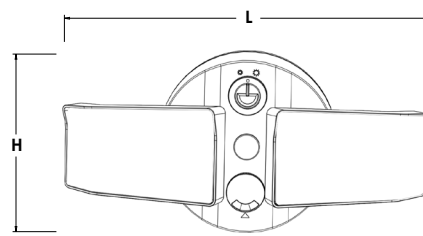

HGX 3RH

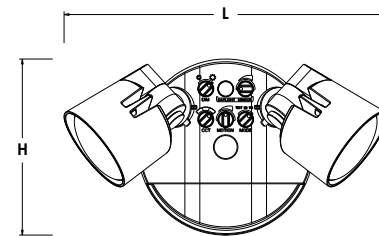
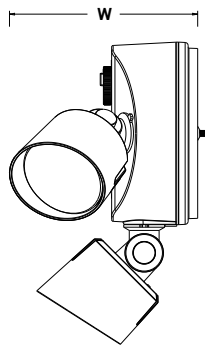

HGX 2RH PIR

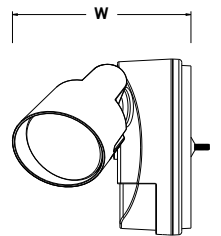

Catalog Number
Notes
Type

Hit the Tab key or mouse over the page to see all interactive elements.

Introduction















The HomeGuard LED family of security flood lights, built with rugged die cast aluminum construction, are long lasting, energy efficient solutions for replacing incandescent PAR lamp fixtures. Mounted under an eave or on a wall, these luminaires provide reliable security lighting in residential and commercial applications (PIR unit is wall mount only).

The HGX family has six configurations both in bronze and white. Featuring a low cost version for switched circuits and fully featured products that include the following options: an integral photocell for that automatic dusk-to-dawn operation, adjustable lumen output, color temperature switchability, and a PIR motion sensor in a wall sconce SKU. With tool-less easy-to-aim lamps, HGX installs quickly, and delivers a lumen range from 1700 to 4100. The HGX family provide great flexibility and versatility.



Ordering Information

EXAMPLE: HGX LED 3RH ALO SWW2 120 PE DDB

Homeguard ordering nomenclature and stocked configurations			
Nomenclature	UPC	CI Code	Features
HGX LED 2RH 40K 120 DDB	00194995254156	*271FE9	
HGX LED 2RH 40K 120 WH	00194995254170	*271FEE	
HGX LED 2RH ALO 40K 120 PE DDB	00194995254200	*271FEF	 
HGX LED 2RH ALO 40K 120 PE WH	00194995254194	*271FEH	
HGX LED 2RH ALO SWW2 120 PE DDB	00194995254255	*271FEP	  
HGX LED 2RH ALO SWW2 120 PE WH	00194995254316	*271FEV	
HGX LED 2SH ALO SWW2 120 PE DDB	00194995255214	*271FJ3	  
HGX LED 2SH ALO SWW2 120 PE WH	00194995255207	*271FJ4	
HGX LED 3RH ALO SWW2 120 PE DDB	00194995255160	*271FHW	  
HGX LED 3RH ALO SWW2 120 PE WH	00194995255139	*271FJO	
HGX LED 2RH ALO SWW2 120 PIR DDB*	00194995254330	*271FEX	   
HGX LED 2RH ALO SWW2 120 PIR WH*	00194995255092	*271FHR	

-  Adjustable Lumen Output ALO
-  Dusk-to-Down Operation PE
-  Switchable CCT SWW2 (3000K/4000K/5000K)
-  Motion Sensor Capable PIR







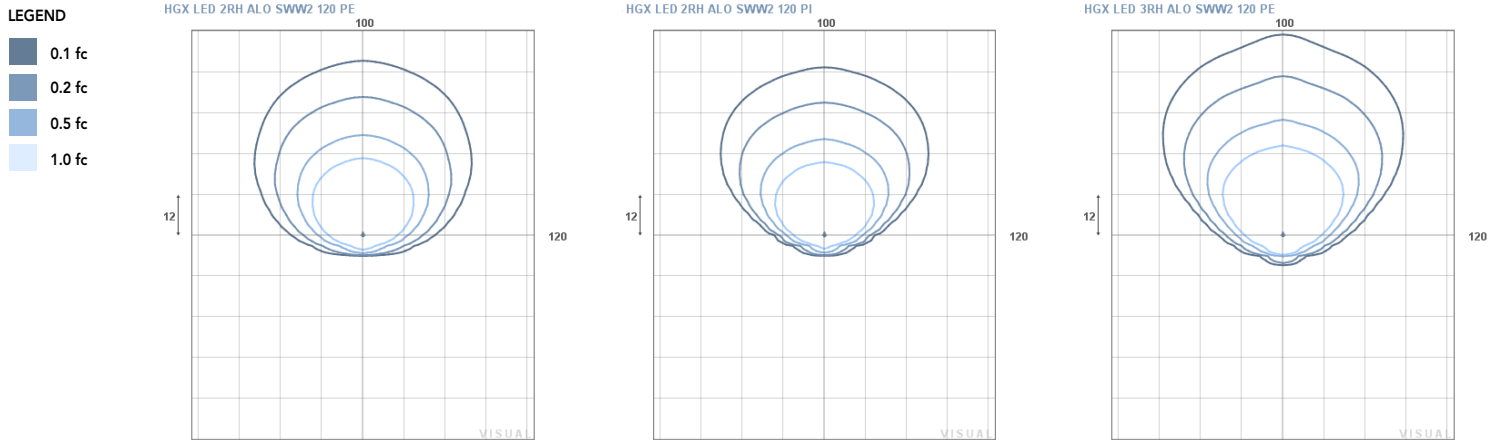







*PIR unit is wet location rated and is to be used for wall mount applications

Photometric Diagrams

Full photometric data report available within 2 weeks from request. Contact Acuity tech support.



HomeGuard LED Stocked Configurations

Nomenclature	Low			Medium			High			Options
	Lumens	Wattage	CRI	Lumens	Wattage	CRI	Lumens	Wattage	CRI	
HGX LED 2RH 40K 120 DDB	1750	15	80				2750	25	80	
HGX LED 2RH 40K 120 WH										
HGX LED 2RH ALO 40K 120 PE DDB	1750	15	80				2750	25	80	 
HGX LED 2RH ALO 40K 120 PE WH										
HGX LED 2RH ALO SWW2 120 PE DDB	1800	15	80				2750	25	80	  
HGX LED 2RH ALO SWW2 120 PE WH										
HGX LED 2SH ALO SWW2 120 PE DDB	1700	15	80				2700	25	80	  
HGX LED 2SH ALO SWW2 120 PE WH										
HGX LED 3RH ALO SWW2 120 PE DDB	1750	15	80	2750	25	80	4100	36	80	  
HGX LED 3RH ALO SWW2 120 PE WH										
HGX LED 2RH ALO SWW2 120 PIR DDB	2150	21	80				2600	26	80	   
HGX LED 2RH ALO SWW2 120 PIR WH										

-  Adjustable Lumen Output
-  Dusk-to-Dawn Operation
-  Switchable CCT
-  Motion Sensor Capable



Easy, tool-less aiming.



Integrated visors allow for visually pleasing illumination with minimal glare.



Modern design with user-friendly controls. Non-obtrusive motion sensor with elegant accent light.



Adjustable Light Output (ALO) and CCT color switching from warm, cool or daylight settings.

FEATURES & SPECIFICATIONS

INTENDED USE

HGX security floods are ideal for an energy efficient replacement for two lamp 200W incandescent security lights. The HGX LED provides over 50K hours of maintenance-free general illumination for outdoor applications. HGX with its 2RH/3RH/2SH head with PE options prevents daylight operation and saves on energy costs. Further with adjustable light output and color tuning technology built into HGX, it provides great flexibility for mounting and color selection. Ideal for entrances, walkways, corridors, yards, driveways and patios.

CONSTRUCTION

Cast-aluminum housing with dark bronze or white polyester powder paint for lasting durability. Photocell sensitivity is adjustable. LED lamp heads are thermally isolated from the driver that is located in the rear housing, promoting a long service life. Lenses are sealed to prolong service life. LEDs maintain 70% of light output at 50,000 hours of service life.

ELECTRICAL

HGX family comes in six configurations from low cost version which is on switched circuit to a fully featured product which has adjustable lumens, photocell, color and motion. The HGX is rated for outdoor installations. The 2 RH versions consume 25W and 3RH version consumes 36W power, 120V input 60 HZ driver. LED's with min. 80 CRI provide great quality of light and rendering. HGX with PIR option (motion sensor) has up to 180 degree motion detection angle, range of up to 40' at 18C/65 F and has three modes - test, 1 or five minutes on time after motion is detected. Motion sensitivity and daylight sensing is adjustable. Wall Sconce PIR unit is recommended for wall mount only.

ADJUSTABLE FEATURES

Adjustable light output - select HGX products include adjustable lumen output -2 settings on 2 head versions & 3 settings on 3 RH version. The lumens can be adjusted by rotation of dial. Use the same product to mount on various mounting heights by increasing or decreasing the light output. Color Tuning - Color temperature of the lamp heads can be switched with rotation of dial from warm to cool to daylight. Adjustable photocell - the sensitivity of the PE can be adjusted. The dial can be turned off to make the light turn on during day time, or have it only as dusk-to-dawn operation.

INSTALLATION

Mounts to a recessed junction box on wall or ceiling. Crossbar and hardware provided. Wet location listed for mounting 4 feet above ground. Tool-less adjustable heads allow for precise aiming.

LISTINGS

UL/cUL listed Listed to U.S. and Canadian safety standards for wet locations. Tested in accordance with IESNA LM-79 and LM-80 standards. All units are IP65 except HGX PIR which is wet location. HGX is rated for use in ambient conditions ranging from -40° C to 40° C.

WARRANTY

Five-year limited warranty. This is the only warranty provided and no other statements in this specification sheet create any warranty of any kind. All other express and implied warranties are disclaimed. Complete warranty terms located at:

www.acuitybrands.com/support/warranty/terms-and-conditions

Note: Actual performance may differ as a result of end-user environment and application. All values are design or typical values, measured under laboratory conditions at 25 °C. Specifications subject to change without notice.



COMMERCIAL OUTDOOR

One Lithonia Way • Conyers, Georgia 30012 • Phone: 1-800-705-SERV (7378) • www.lithonia.com
© 2024 Acuity Brands Lighting, Inc. All rights reserved.

HGX LED
Rev. 11/06/24