







Siemens  
EcoTech



LED module with integrated LED 6-24V AC/DC amber, Spring-loaded terminal, for front plate mounting



product brand name	SIRIUS ACT
product designation	LED module
product type designation	3SU1
<b>General technical data</b>	
product component	
• diode	Yes
• lamp transformer	No
• light source	Yes
• series resistor	No
insulation voltage rated value	320 V
degree of pollution	3
type of voltage of the operating voltage	AC/DC
• for actuation	AC/DC
surge voltage resistance rated value	4 kV
consumed current maximum	30 mA
protection class IP	
• of the enclosure	IP40
• of the terminal	IP20
shock resistance	
• according to IEC 60068-2-27	sinusoidal half-wave 15g / 11 ms
• for railway applications according to EN 61373	Category 1, Class B
vibration resistance	
• according to IEC 60068-2-6	10 ... 500 Hz: 5g
• for railway applications according to EN 61373	Category 1, Class B
operating period typical	100 000 h
reference code according to IEC 81346-2	P
Substance Prohibitance (Date)	10/01/2014
SVHC substance name	Lead monoxide (lead oxide) - 1317-36-8 2,2',6,6'-tetrabromo-4,4'-isopropylidenediphenol - 79-94-7
Weight	8 g
operating voltage	
• at AC	
— at 50 Hz rated value	6 ... 24 V
— at 60 Hz rated value	6 ... 24 V
• at DC rated value	6 ... 24 V
relative positive tolerance of the operating voltage	20 %
relative negative tolerance of the operating voltage	20 %

Control circuit/ Control		
<b>inrush current maximum</b>	2 A	
Connections/ Terminals		
<b>type of electrical connection</b>	spring-loaded terminals	
<b>type of connectable conductor cross-sections</b>		
<ul style="list-style-type: none"> <li>• solid without core end processing</li> <li>• finely stranded with core end processing</li> <li>• finely stranded without core end processing</li> <li>• for AWG cables</li> </ul>	2x (0.25 ... 1.5 mm <sup>2</sup> ) 2x (0.25 ... 0.75 mm <sup>2</sup> ) 2x (0.25 ... 1.5 mm <sup>2</sup> ) 2x (24 ... 16)	
connectable conductor cross-section finely stranded with core end processing	0.25 ... 0.75 mm <sup>2</sup>	
Lamp		
<b>type of light source</b>	LED	
<b>color of the light source</b>	amber	
<b>light intensity</b>	450 ... 1 120 mcd	
ATEX		
<b>certificate of suitability</b>		
<ul style="list-style-type: none"> <li>• ATEX</li> <li>• IECEx</li> </ul>	No No	
Ambient conditions		
<b>ambient temperature</b>		
<ul style="list-style-type: none"> <li>• during operation</li> <li>• during storage</li> </ul>	-25 ... +70 °C -40 ... +80 °C	
environmental category during operation according to IEC 60721	3M6, 3S2, 3B2, 3C3, 3K6 (with relative air humidity of 10 ... 95%, no condensation in operation permitted)	
Environmental footprint		
Environmental Product Declaration (EPD)	Yes	
global warming potential [CO2 eq] total	0.787 kg	
global warming potential [CO2 eq] during manufacturing	0.566 kg	
global warming potential [CO2 eq] during operation	0.235 kg	
global warming potential [CO2 eq] after end of life	-0.015 kg	
Siemens Eco Profile (SEP)	Siemens EcoTech	
Installation/ mounting/ dimensions		
<b>fastening method</b>		
<ul style="list-style-type: none"> <li>• of modules and accessories</li> </ul>	Front plate mounting	
<b>height</b>	36 mm	
<b>width</b>	9.8 mm	
<b>depth</b>	29.4 mm	
Approvals Certificates		
<b>General Product Approval</b>	<b>Test Certificates</b>	
 	 	
<a href="#">Confirmation</a>	<a href="#">Type Test Certificates/Test Report</a>	
<b>Test Certificates</b>	<b>other</b>	<b>Environment</b>
<a href="#">Special Test Certificate</a>	<a href="#">Confirmation</a>	 
		<a href="#">Environmental Confirmations</a>
Further information		
<b>Information on the packaging</b>		
<a href="https://support.industry.siemens.com/cs/ww/en/view/109813875">https://support.industry.siemens.com/cs/ww/en/view/109813875</a>		
<b>Information- and Downloadcenter (Catalogs, Brochures,...)</b>		
<a href="https://www.siemens.com/ic10">https://www.siemens.com/ic10</a>		
<b>Industry Mall (Online ordering system)</b>		
<a href="https://mall.industry.siemens.com/mall/en/en/Catalog/product?mlfb=3SU1401-1BG00-3AA0">https://mall.industry.siemens.com/mall/en/en/Catalog/product?mlfb=3SU1401-1BG00-3AA0</a>		
<b>Cax online generator</b>		
<a href="http://support.automation.siemens.com/WW/CAXorder/default.aspx?lang=en&amp;mlfb=3SU1401-1BG00-3AA0">http://support.automation.siemens.com/WW/CAXorder/default.aspx?lang=en&amp;mlfb=3SU1401-1BG00-3AA0</a>		

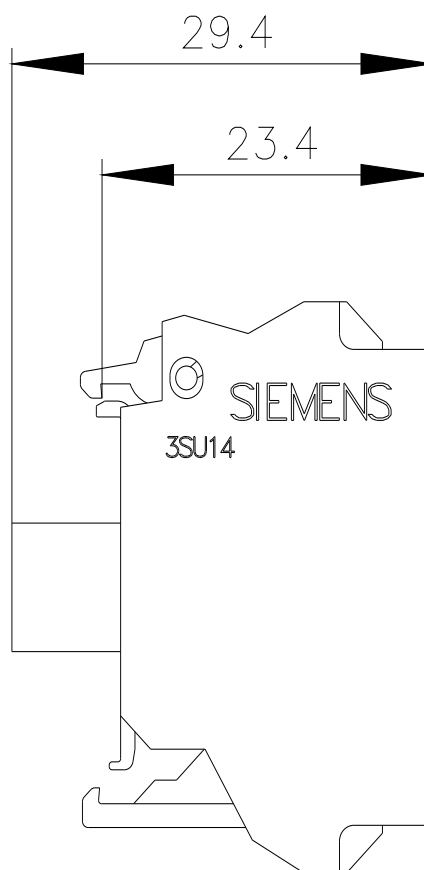
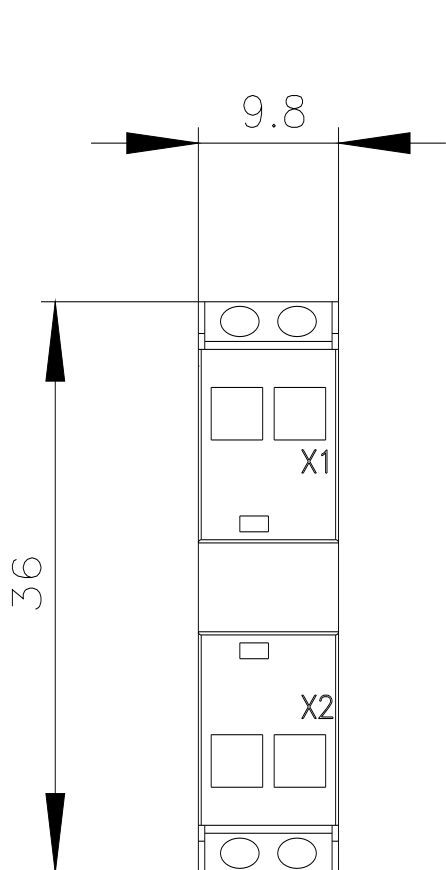

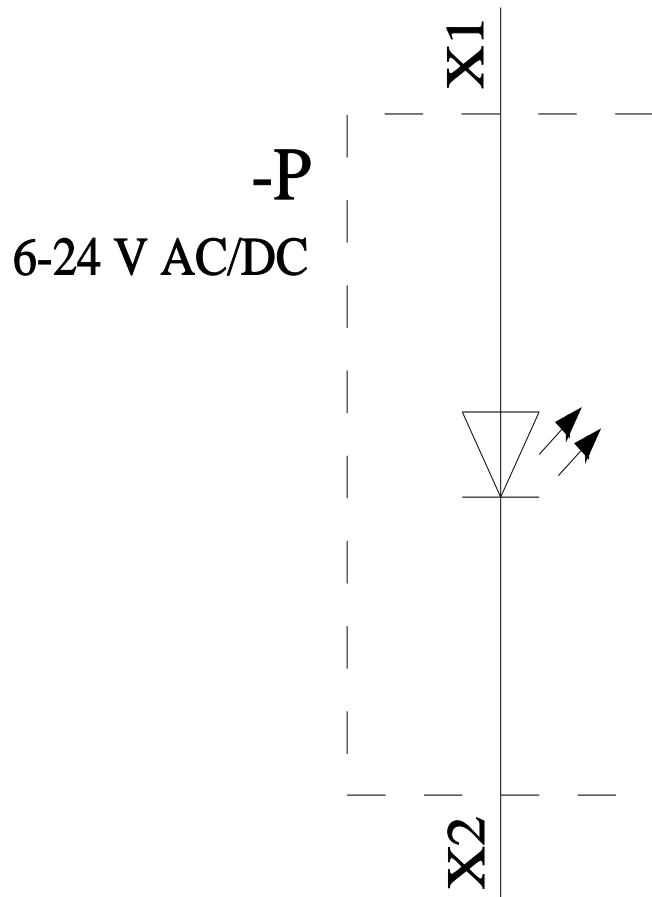

last modified:

3/11/2024 