







Siemens
EcoTech



LED module with integrated LED 6-24V AC/DC yellow, Spring-loaded terminal, for front plate mounting



product brand name	SIRIUS ACT
product designation	LED module
product type designation	3SU1
General technical data	
product component	
• diode	Yes
• lamp transformer	No
• light source	Yes
• series resistor	No
insulation voltage rated value	320 V
degree of pollution	3
type of voltage of the operating voltage	AC/DC
• for actuation	AC/DC
surge voltage resistance rated value	4 kV
consumed current maximum	30 mA
protection class IP	
• of the enclosure	IP40
• of the terminal	IP20
shock resistance	
• according to IEC 60068-2-27	sinusoidal half-wave 15g / 11 ms
• for railway applications according to EN 61373	Category 1, Class B
vibration resistance	
• according to IEC 60068-2-6	10 ... 500 Hz: 5g
• for railway applications according to EN 61373	Category 1, Class B
operating period typical	100 000 h
reference code according to IEC 81346-2	P
Substance Prohibitance (Date)	10/01/2014
SVHC substance name	Lead monoxide (lead oxide) - 1317-36-8 2,2',6,6'-tetrabromo-4,4'-isopropylidenediphenol - 79-94-7
Weight	8 g
operating voltage	
• at AC	
— at 50 Hz rated value	6 ... 24 V
— at 60 Hz rated value	6 ... 24 V
• at DC rated value	6 ... 24 V
relative positive tolerance of the operating voltage	20 %
relative negative tolerance of the operating voltage	20 %

Control circuit/ Control		
inrush current maximum	2 A	
Connections/ Terminals		
type of electrical connection	spring-loaded terminals	
type of connectable conductor cross-sections		
<ul style="list-style-type: none"> • solid without core end processing • finely stranded with core end processing • finely stranded without core end processing • for AWG cables 	2x (0.25 ... 1.5 mm ²) 2x (0.25 ... 0.75 mm ²) 2x (0.25 ... 1.5 mm ²) 2x (24 ... 16)	
connectable conductor cross-section finely stranded with core end processing	0.25 ... 0.75 mm ²	
Lamp		
type of light source	LED	
color of the light source	yellow	
light intensity	900 ... 1 400 mcd	
ATEX		
certificate of suitability		
<ul style="list-style-type: none"> • ATEX • IECEx 	No No	
Ambient conditions		
ambient temperature		
<ul style="list-style-type: none"> • during operation • during storage 	-25 ... +70 °C -40 ... +80 °C	
environmental category during operation according to IEC 60721	3M6, 3S2, 3B2, 3C3, 3K6 (with relative air humidity of 10 ... 95%, no condensation in operation permitted)	
Environmental footprint		
Environmental Product Declaration (EPD)	Yes	
global warming potential [CO2 eq] total	0.787 kg	
global warming potential [CO2 eq] during manufacturing	0.566 kg	
global warming potential [CO2 eq] during operation	0.235 kg	
global warming potential [CO2 eq] after end of life	-0.015 kg	
Siemens Eco Profile (SEP)	Siemens EcoTech	
Installation/ mounting/ dimensions		
fastening method		
<ul style="list-style-type: none"> • of modules and accessories 	Front plate mounting	
height	36 mm	
width	9.8 mm	
depth	29.4 mm	
Approvals Certificates		
General Product Approval	EMV	Test Certificates
    		Type Test Certificates/Test Report
Test Certificates	other	Environment
Special Test Certificate	Confirmation	  Environmental Confirmations
Further information		
Information on the packaging https://support.industry.siemens.com/cs/ww/en/view/109813875 Information- and Downloadcenter (Catalogs, Brochures,...) https://www.siemens.com/ic10 Industry Mall (Online ordering system) https://mall.industry.siemens.com/mall/en/en/Catalog/product?mlfb=3SU1401-1BG30-3AA0 Cax online generator http://support.automation.siemens.com/WW/CAXorder/default.aspx?lang=en&mlfb=3SU1401-1BG30-3AA0		

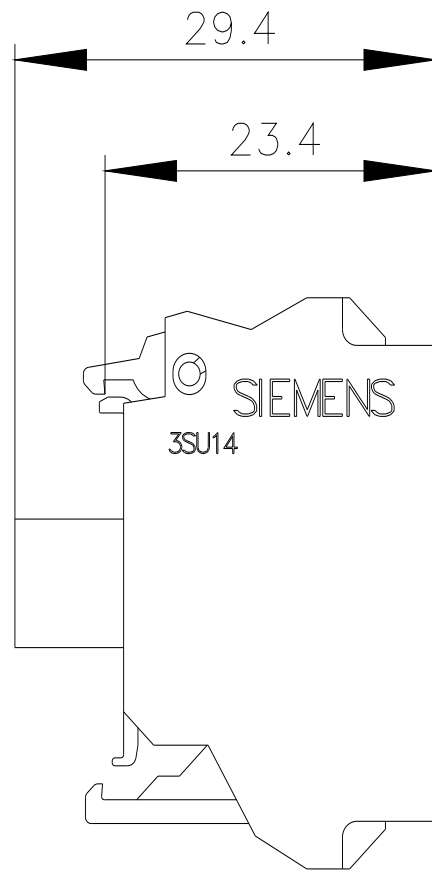
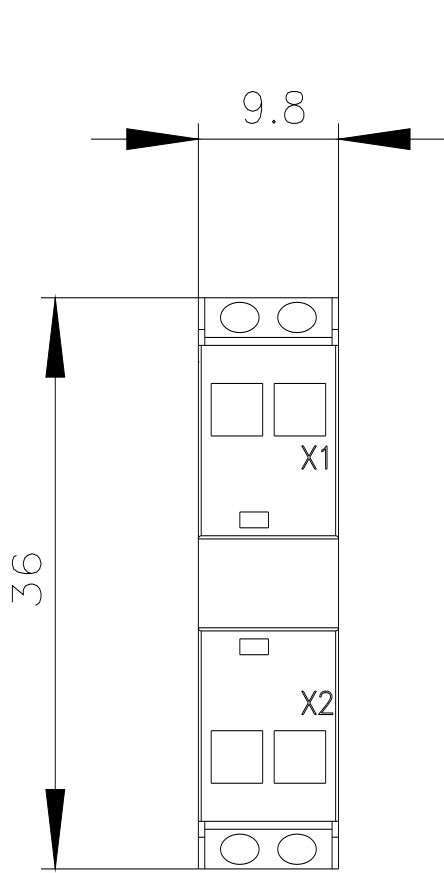

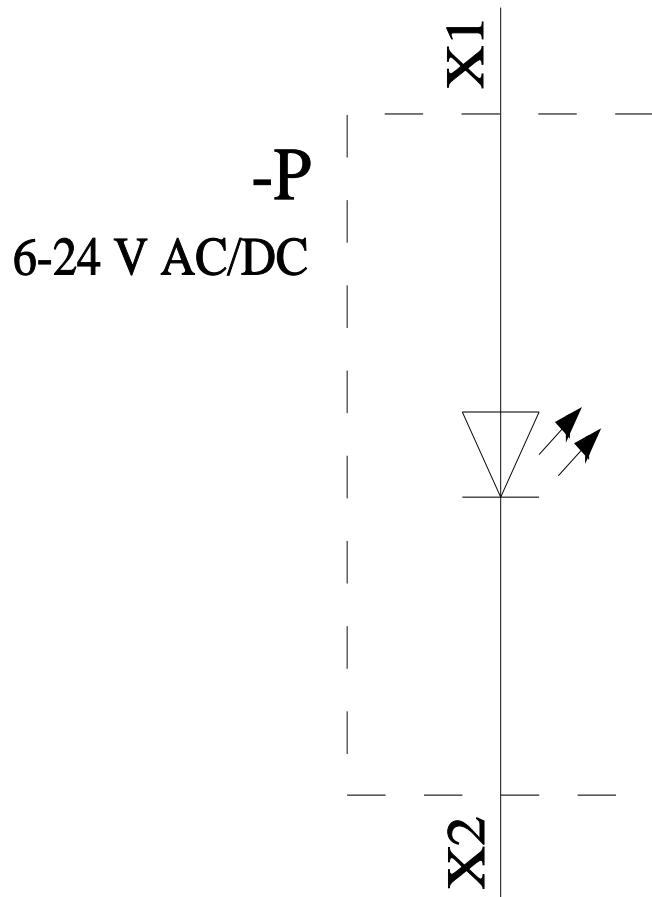

last modified:

4/2/2025 