

SFE/SFECM | THE FURNACE

MODULATING ELECTRIC FURNACES WITH ELECTRONIC CONTROLS



THE FURNACE



THE ALL-INCLUSIVE FURNACE

At last, °STELPRO has designed an electric furnace that meets all your expectations. THE FURNACE is the only one on the market that comes equipped with a built-in temperature sensor, making installation much easier. You can say goodbye to undesirable variances in temperature thanks to its state-of-the-art electronic controls! This compact, one-of-a-kind furnace has everything going for it, including easy installation and incomparable ease of use among many other outstanding features. See for yourself; °STELPRO's THE FURNACE has no equal!

ECM MOTOR

GUARANTEES SAVINGS, CONSTANT AIRFLOW AND GREATER EFFICIENCY (SFECM MODEL)

BUILT-IN TEMPERATURE SENSOR

REDUCED SIZE

PRE-DRILLED PANELS SIMPLIFIES INSTALLATION AND CONNECTION

UPDATED ELECTRONIC CONTROLS

ECO MODE FOR INCREASED SAVINGS

AVAILABLE WITH A 120 V MOTOR (up to 27 kW)

1 HP MOTOR ALSO AVAILABLE (starting from 20 kW)

COMPATIBLE WITH HEAT PUMP INSTALLATIONS

FINISH

- powdercoat (charcoal)

MANUFACTURING

- robust galvanized steel cabinet
- adjustable dampers providing better control over static pressure, airflow, ΔT and noise (SFE model)
- compartmentalized door providing easy access to all components
- disposable 20 in. x 20 in. air filter (included)
- one type of relay for all functions

ELEMENTS

- modulating elements for increased comfort and separately framed allowing for quick and easy replacement

MOTOR

- totally enclosed, permanently lubricated motor
- ECM – electronically commutated motor (SFECM model)

CONTROL

- easy-to-use modes
- Continuous ventilation button (low or high speed)
- Continuous heating button (min or max)
- simplified connection system
- mechanical relays allowing for easy and low-cost maintenance

INSTALLATION

- three possible installation positions: upflow, downflow or horizontal
- installation directly against a wall ("zero inch" clearance)
- possible installation with three conductors

WARRANTY

- five years

°STELPRO

°STELPRO reserves the right to modify descriptions, manufacturing specifications or prices without prior notice. No returns accepted on optional-colour products. For all the latest models and prices, please refer to our website at www.stelpro.com.



FC_SFE-SFECM_EN_311018

ELECTRONIC CONTROLS

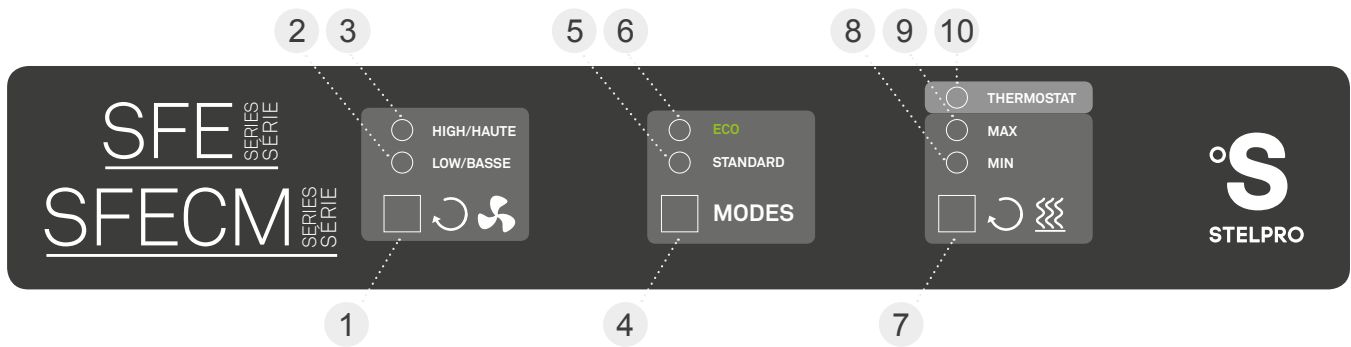

LEGEND

- 1 CONTINUOUS VENTILATION BUTTON**
Allows the selection of the high or low speed continuous ventilation mode.
- 2 LOW SPEED CONTINUOUS VENTILATION GREEN LED**
Indicates that the low speed continuous ventilation mode is activated.
- 3 HIGH SPEED CONTINUOUS VENTILATION GREEN LED**
Indicates that the high speed continuous ventilation mode is activated.
- 4 MODE BUTTON**
Allows the selection of the Standard or Eco mode.
- 5 STANDARD MODE GREEN LED**
Indicates Standard mode is activated.
- 6 ECO MODE GREEN LED**
Indicates that the Eco mode is activated.
- 7 CONTINUOUS HEATING BUTTON**
Allows the selection of the maximum or minimum continuous heating mode.
- 8 MIN CONTINUOUS HEATING GREEN LED**
Indicates that the minimum heating capacity is activated.
- 9 MAX CONTINUOUS HEATING GREEN LED**
Indicates that the maximum continuous heating mode is activated.
- 10 THERMOSTAT YELLOW LED**
Indicates that the furnace is receiving a heating request from the thermostat.



TECHNICAL SPECIFICATIONS





PRODUCT	POWER AND VOLTAGE		MOTOR		AMPERAGE	POWER	WEIGHT	
CODE	KILOWATTS	VOLTS	SPEED	VOLTS	AMPERES	HP	KG	LB
SFE SERIES – STANDARD MODELS								
SFE1021	10/7.5	240/208	4	240/208	44/38	1/3	45	100
SFE1521	15/11.2	240/208	4	240/208	65/56	1/3	45	100
SFE1821	17.5/13.2	240/208	4	240/208	75/66	1/3	45	100
SFE2021	20/15	240/208	4	240/208	85/74	1/3	45	100
SFE2321	22.5/16.9	240/208	4	240/208	96/84	1/3	45	100
SFE2721	27.5/20.7	240/208	3	240/208	119/104	1	48	105
SFE3021	30/22.5	240/208	3	240/208	130/113	1	48	105
SFE SERIES – OPTIONAL MODELS								
SFE1021120	10/7.5	240/208	4	120	46/40	1/3	45	100
SFE1521120	15/11.2	240/208	4	120	67/58	1/3	45	100
SFE1821120	17.5/13.2	240/208	4	120	77/68	1/3	45	100
SFE2021120	20/15	240/208	4	120	87/76	1/3	45	100
SFE20211HP	20/15	240/208	3	240/208	88/77	1	48	105
SFE20211HP120	20/15	240/208	3	120	95/84	1	48	105
SFE2321120	22.5/16.9	240/208	4	120	98/86	1/3	45	100
SFE23211HP	22.5/16.9	240/208	3	240/208	99/87	1	48	105
SFE23211HP120	22.5/16.9	240/208	3	120	106/94	1	48	105
SFE2721120	27.5/20.7	240/208	3	120	126/111	1	48	105
SFECEM SERIES – STANDARD MODELS								
SFECEM1021	10/7.5	240/208	MULTI	240/208	44/38	1/2	45	100
SFECEM1521	15/11.2	240/208	MULTI	240/208	65/56	1/2	45	100
SFECEM1821	17.5/13.2	240/208	MULTI	240/208	75/66	1/2	45	100
SFECEM2021	20/15	240/208	MULTI	240/208	85/74	1/2	45	100
SFECEM2321	22.5/16.9	240/208	MULTI	240/208	96/84	1/2	45	100
SFECEM2721	27.5/20.7	240/208	MULTI	240/208	119/104	1	48	105
SFECEM3021	30/22.5	240/208	MULTI	240/208	130/113	1	48	105
SFECEM SERIES – OPTIONAL MODELS								
SFECEM1021120	10/7.5	240/208	MULTI	120	46/40	1/2	45	100
SFECEM1521120	15/11.2	240/208	MULTI	120	67/58	1/2	45	100
SFECEM1821120	17.5/13.2	240/208	MULTI	120	77/68	1/2	45	100
SFECEM2021120	20/15	240/208	MULTI	120	87/76	1/2	45	100
SFECEM20211HP	20/15	240/208	MULTI	240/208	88/77	1	48	105
SFECEM20211HP120	20/15	240/208	MULTI	120	95/84	1	48	105
SFECEM2321120	22.5/16.9	240/208	MULTI	120	98/86	1/2	45	100
SFECEM23211HP	22.5/16.9	240/208	MULTI	240/208	99/87	1	48	105
SFECEM23211HP120	22.5/16.9	240/208	MULTI	120	106/94	1	48	105
SFECEM2721120	27.5/20.7	240/208	MULTI	120	126/111	1	48	105

ACCESSORIES

PRODUCT	DESCRIPTION
FSB2	SFE furnace downflow adaptor
SCOND	neutral terminal for third conductor

SFE SERIES

SPEEDS AND DAMPERS

UNIT	ESP	DAMPER 1	DAMPER 2	L		ML		MH		H			
KW	IWC	DEGREES	DEGREES	CFM	ΔT (°F)	CFM	ΔT (°F)	CFM	ΔT (°F)	CFM	ΔT (°F)	KW (MIN)	KW (MAX)
10 KW TO 22.5 KW – 1/3 HP MOTOR													
10	0.2	15	15	810	39	900*	35*	930	34	960	33	2.5	2.5
15	0.2	45	45	862	55	1000*	48*	1130	42	1200	39	2.5	5
17.5	0.2	45	45	862	64	1000*	55*	1130	48	1200	46	2.5	5
20	0.2	60	45	900	70	1030	61	1150*	55*	1240	51	2.5	5
22.5	0.2	60	45	900	78	1030	69	1150*	62*	1240	57	2.5	5
10	0.5	15	15	685	46	750*	42*	790	40	850	37	2.5	2.5
15	0.5	45	45	790	60	890*	53*	990	48	1030	46	2.5	5
17.5	0.5	45	45	790	70	890*	62*	990	56	1030	54	2.5	5
20	0.5	60	45	815	78	910	70	1000*	63*	1050	60	2.5	5
22.5	0.5	60	45	815	87	910	79	1000*	71*	1050	67	2.5	5
UNIT	ESP	DAMPER 1	DAMPER 2	L		M		H					
KW	IWC	DEGREES	DEGREES	CFM	ΔT (°F)	CFM	ΔT (°F)	CFM	ΔT (°F)	KW (MIN)	KW (MAX)		
20 KW TO 30 KW – 1 HP MOTOR													
20	0.2	60	45	1620	39	1820*	35*	2030	31	2.5	5		
22.5	0.2	60	45	1620	44	1820*	39*	2030	35	2.5	5		
27.5	0.2	60	45	1600	54	1790*	48*	2000	43	2.5	7.5		
30	0.2	60	45	1600	59	1790*	53*	2000	48	5	10		
20	0.5	60	45	1540	41	1700*	37*	1915	33	2.5	5		
22.5	0.5	60	45	1540	46	1700*	42*	1915	37	2.5	5		
27.5	0.5	60	45	1500	58	1660*	51*	1875	46	2.5	7.5		
30	0.5	60	45	1500	63	1660*	57*	1875	51	5	10		
20	0.75	60	45	1475	43	1625*	39*	1775	36	2.5	5		
22.5	0.75	60	45	1475	48	1625*	44*	1775	40	2.5	5		
27.5	0.75	60	45	1440	60	1600*	54*	1740	50	2.5	7.5		
30	0.75	60	45	1440	66	1600*	60*	1740	55	5	10		

L = low; ML = medium/low; M = medium; MH = medium/high; H = high
 Speeds and dampers are factory adjusted.
 * Recommended (factory pre-cabled)

  = CONTINUOUS HEATING



SFECM SERIES

AIRFLOW SETTINGS

The SFECM furnace is equipped with an efficient ECM motor that can maintain constant airflow regardless of the static pressure variation in the ducts. It also ensures an easy setting of the airflows related to each operation mode of the furnace blower. The blower has four adjustments. A potentiometer that makes airflow adjustment possible corresponds to each of these four modes. The potentiometers are located on the furnace control card. The adjustment scales vary from one model to the other according to the capacity of the unit.

The airflows can be adjusted while the furnace is running. To adjust airflows, you must set the potentiometers to the desired values.

AIRFLOW SETTINGS EXAMPLE – SFECM2021

SETTING	CONTINUOUS VENTILATION		W VENTILATION		Y VENTILATION
	LOW	HIGH	W1	W2	
1	300	700	450	1150	800
2	366	766	615	1315	908
3	433	833	785	1450	1016
4	500	900	950	1450	1125
5	566	966	1115	1450	1234
6	633	1033	1285	1450	1342
7	700	1100	1450	1450	1450

■ Recommended

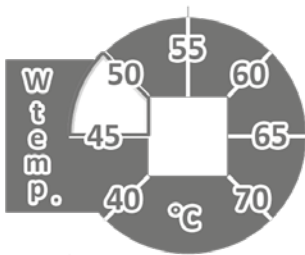

HEATING TEMPERATURE

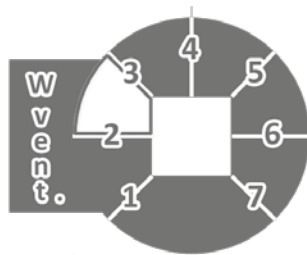

HEATING VENTILATION

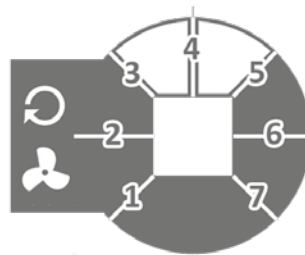

CONTINUOUS VENTILATION

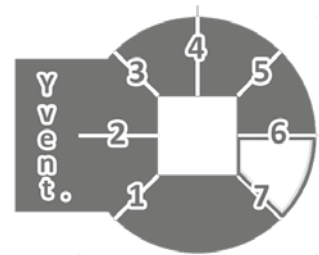

Y VENTILATION

ECM MOTOR – ELECTRONICALLY COMMUTATED MOTOR

COMFORT, EFFICIENCY, RELIABILITY AND SECURITY ARE AT THE HEART OF THE ECM

COMFORT

Comfort level can be increased if a variable speed motor is installed. This level cannot be reached with any other method. It also allows the user to select the low speed with the desired airflow in recirculation.

EFFICIENCY

Since it combines electronic circuits and a BLDC motor, it is the most efficient motor on the HVAC market. It can reach up to twice the capacity of a PSC motor.

RELIABILITY

All its electronic circuits are protected against condensation. Thanks to its design and materials, like silicone elastomer, it is one of the most reliable motors on the market.

SECURITY

Its electronic system is protected by MOVs (metal oxide varistors) against lightning overvoltages.

TECHNICAL DRAWINGS

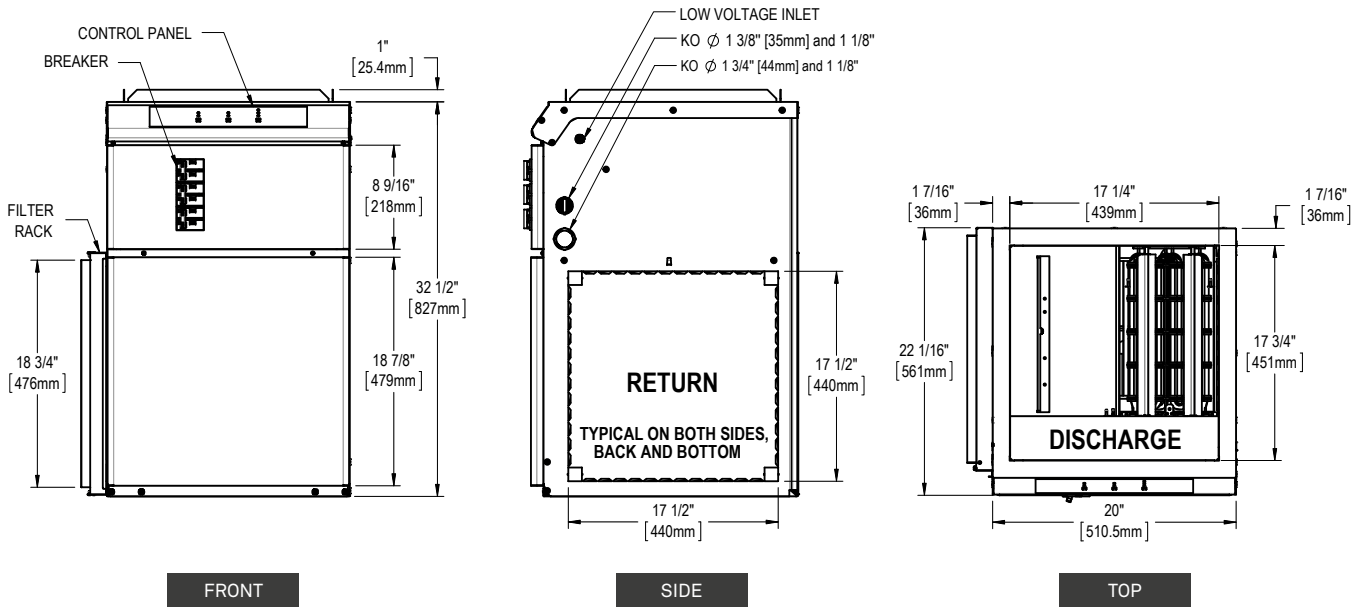

INSTALLATION

