

CEMA 1 LAY-IN WIREWAY

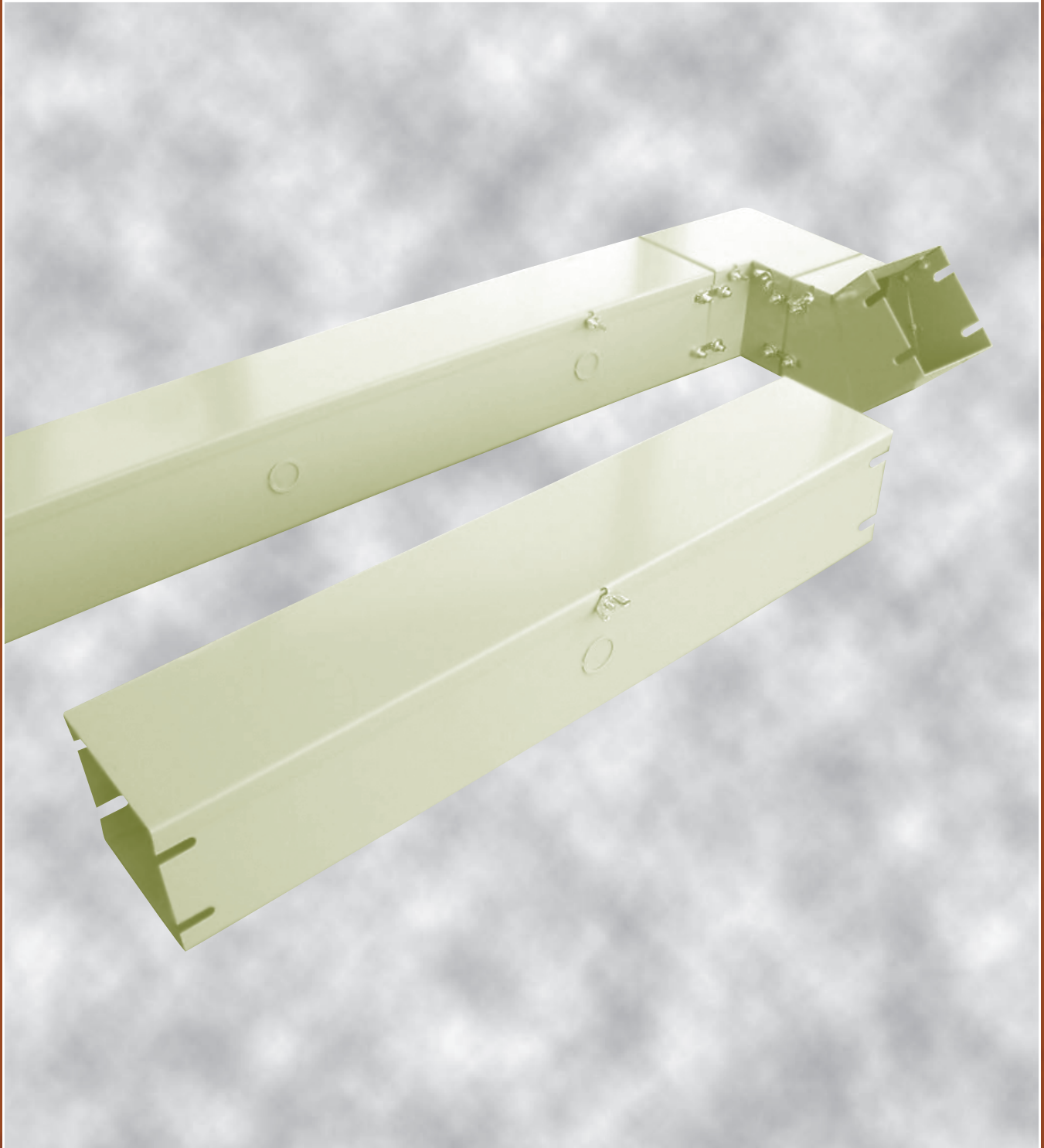

TYPICAL RACEWAY LENGTH

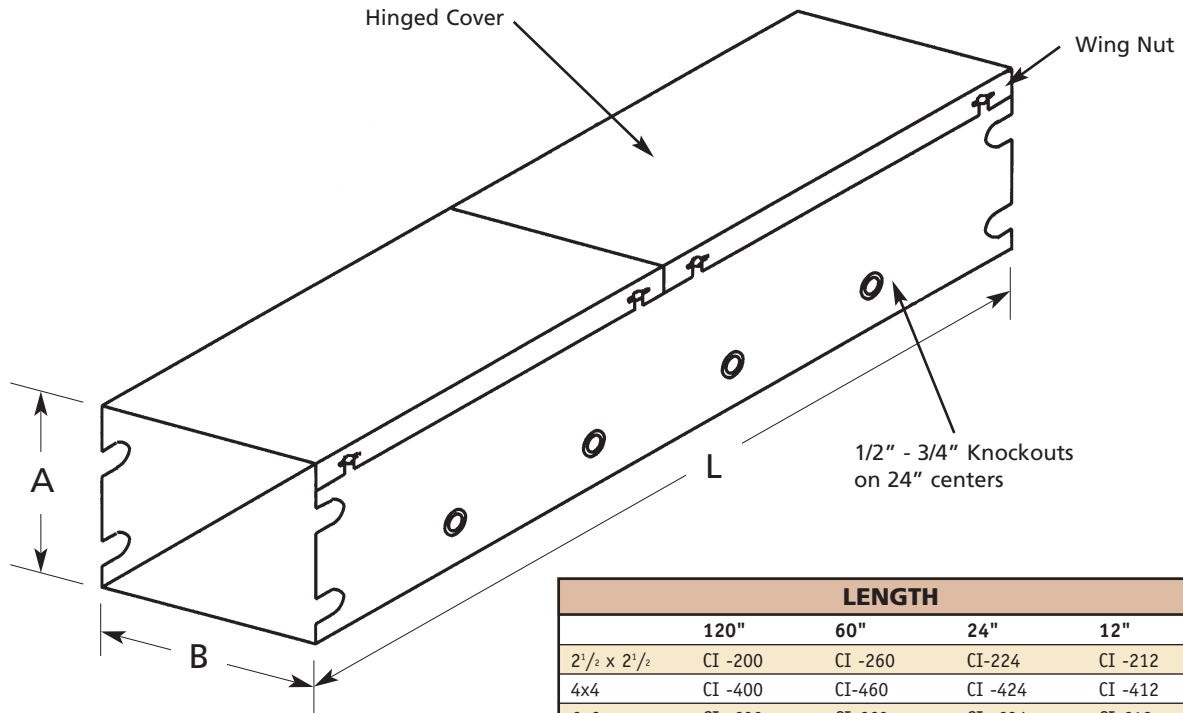

LENGTH				
	120"	60"	24"	12"
2 1/2 x 2 1/2	CI -200	CI -260	CI-224	CI -212
4x4	CI -400	CI-460	CI -424	CI -412
6x6	CI -600	CI-660	CI -624	CI-612
8x8	CI -800	CI-860	CI -824	CI-812
12x12	CI -1200	CI-1260	CI-1224	CI-1212

ELBOWS

90°

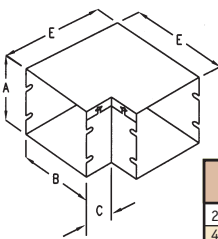

90° ELBOW TOP COVER	
2 1/2 x 2 1/2	CI-2E90
4 x 4	CI-4E90
6 x 6	CI-6E90
8 x 8	CI-8E90
12 x 12	CI-12E90

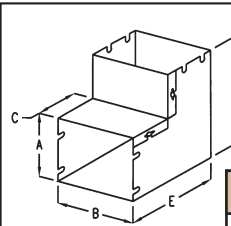

90° ELBOW INSIDE COVER	
2 1/2 x 2 1/2	CI-2I90
4 x 4	CI-4I90
6 x 6	CI-6I90
8 x 8	CI-8I90
12 x 12	CI-12I90

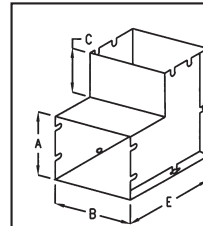

90° ELBOW OUTSIDE COVER	
2 1/2 x 2 1/2	CI-2O90
4 x 4	CI-4O90
6 x 6	CI-6O90
8 x 8	CI-8O90
12 x 12	CI-12O90

45°

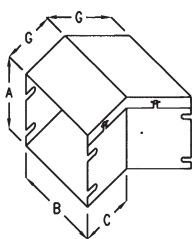

45° ELBOW TOP COVER	
2 1/2 x 2 1/2	CI-2E45
4 x 4	CI-4E45
6 x 6	CI-6E45
8 x 8	CI-8E45
12 x 12	CI-12E45

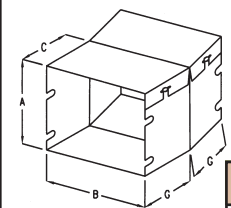

45° ELBOW INSIDE COVER	
2 1/2 x 2 1/2	CI-2I45
4 x 4	CI-4I45
6 x 6	CI-6I45
8 x 8	CI-8I45
12 x 12	CI-12I45

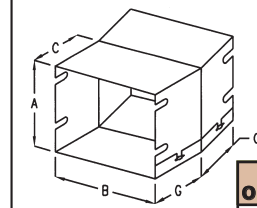

45° ELBOW OUTSIDE COVER	
2 1/2 x 2 1/2	CI-2O45
4 x 4	CI-4O45
6 x 6	CI-6O45
8 x 8	CI-8O45
12 x 12	CI-12O45

TEE FITTING

TEE FITTING		
2 1/2 x 2 1/2	C1-2T	
4 x 4	C1-4T	
6 x 6	C1-6T	
8 x 8	C1-8T	
12 x 12	C1-12T	

REDUCER

REDUCER		
4-2 1/2	C1-42R	
6-4	C1-64R	
8-6	C1-86R	
12-8	C1-128R	

CROSS FITTING

CROSS FITTING		
2 1/2 x 2 1/2	C1-2X	
4 x 4	C1-4X	
6 x 6	C1-6X	
8 x 8	C1-8X	
12 x 12	C1-12X	

END BLANK

END BLANK		
2 1/2 x 2 1/2	C1-2EB	
4 x 4	C1-4EB	
6 x 6	C1-6EB	
8 x 8	C1-8EB	
12 x 12	C1-12EB	

HANGER

HANGER		
2 1/2 x 2 1/2	C1-2H	
4 x 4	C1-4H	
6 x 6	C1-6H	
8 x 8	C1-8H	
12 x 12	C1-12H	

WALL BRACKET

WALL BRACKET		
2 1/2 x 2 1/2	C1-2WB	
4 x 4	C1-4WB	
6 x 6	C1-6WB	
8 x 8	C1-8WB	
12 x 12	C1-12WB	

PARTITION

PARTITION (Field Installed)		
2 1/2 x 2 1/2	C1-2P-L	
4 x 4	C1-4P-L	
6 x 6	C1-6P-L	
8 x 8	C1-8P-L	
12 x 12	C1-12P-L	

PANEL FLANGE

PANEL FLANGE		
2 1/2 x 2 1/2	C1-2F	
4 x 4	C1-4F	
6 x 6	C1-6F	
8 x 8	C1-8F	
12 x 12	C1-12F	

COUPLING

COUPLING		
2 1/2 x 2 1/2	C1-2C	
4 x 4	C1-4C	
6 x 6	C1-6C	
8 x 8	C1-8C	
12 x 12	C1-12C	

SIZE	A	B	C	D	E	F	G	H
2 1/2 x 2 1/2	2 1/2	2 1/2	2	6 5/8	4 5/8	4	3	6
4 x 4	4	4	2	8 1/8	6 1/8	6	3 5/8	9
6 x 6	6	6	2	10 1/8	8 1/8	8	4 1/2	13
8 x 8	8	8	2	12 1/8	10 1/8	10	5 3/8	17
12 x 12	12	12	2	16 1/8	14 1/8	12	7	25

TYPICAL SPECIFICATIONS

Designed to protect wiring in applications where dust, dirt, oil and water are not serious problems. All wireway sections and fittings are open on one side for lay in installation. No "pulling through" is necessary. A large selection of size ranges are available from 2.5" X 2.5" up to 12" X 12".

CONSTRUCTION

- CSA certified
- Code gauge cold rolled steel
- Phosphated then polyester powder coated - standard colour ASA61 Gray
- 1/2" - 3/4" combination Knockouts on 24" centers.
- Covers held closed with captured plated screws and easily installed wing nuts (supplied).
- Coupling supplied with each length of wireway

SPECIALS

- A wide range of colours available
- Available in galvanized steel use suffix "G"
- Other sizes in width and depth combinations up to 12" X 12" readily available
- Factory installed dividers available - may also be ordered separately for on site installation.