

Tray Covers

- Tray covers are available for all classes of tray. They should be installed where falling objects may damage cables or where vertical tray run is accessible by pedestrian or vehicular traffic.

Cover mounting hardware must be ordered separately.

Solid Covers

- These covers provide maximum mechanical protection for cables with limited heat build up. Solid covers are available with or without flange.

Flanged covers have 1/2" flange.

Cover mounting hardware must be ordered separately.

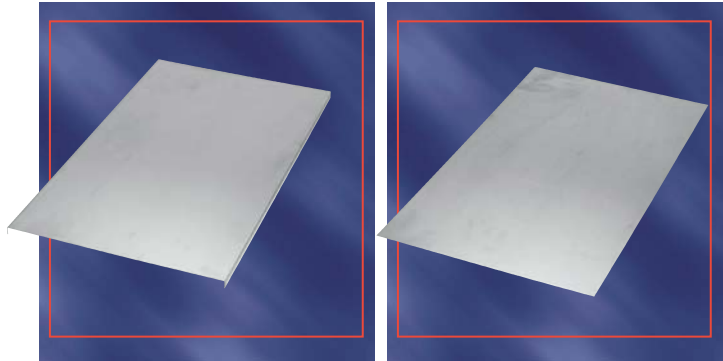

Ventilated Flanged Covers

- This design offers excellent mechanical protection while allowing heat produced by cables to dissipate.

Cover mounting hardware must be ordered separately.

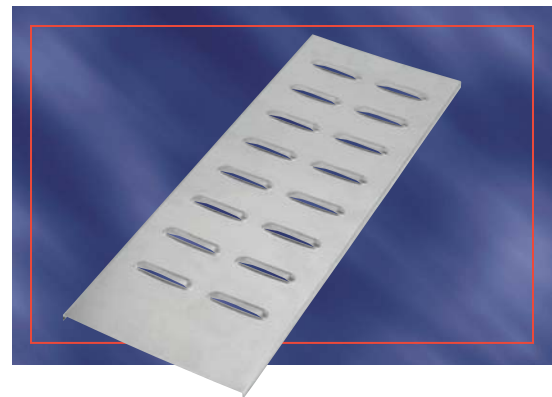

Peaked Flanged Covers

- Peaked covers offer mechanical protection reduce pooling of liquids on the cover and accumulation of snow or ice.

Peaked covers have 15° rise.

Covers greater than 12" wide available in 72" and 3m lengths only.

Cover mounting hardware must be ordered separately.

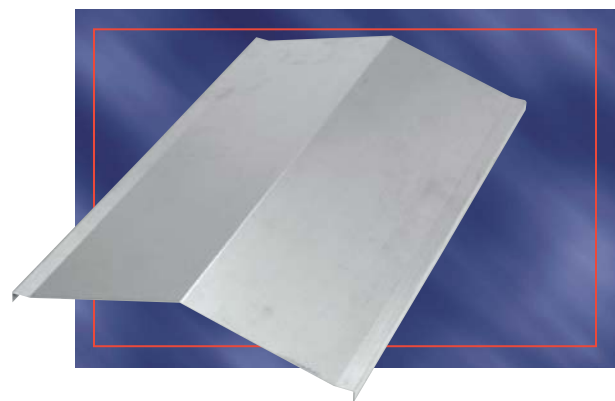

Covers Straight Cover Number Selection

Aluminum Cable Tray

Straight Cover Number Selection

(ABW - 1 - 12) - SNC - 72

Material	Cover Series	Width	Cover Type	Length
ABW • Aluminum Accessory	1 • For tray series: AH04, AH14 2 • For tray series: AH06, AH24, AH34, AH44, AH54, AH25, AH35, AH45, AH16, AH26 3 • For tray series: AH36, AH46, AH56, AH66, AH27, AH76, AH37	06 • (6") 09 • (9") 12 • (12") 18 • (18") 24 • (24") 30 • (30") 36 • (36")	SNC • Solid Non-Flanged Cover SFC • Solid Flanged Cover VFC • Ventilated Flanged Cover *PFC • Peaked Flanged Cover	72 • (72") 144 • (12ft) 3 • (3 m)

* Peaked covers greater than 12" wide available in 72" and 3m lengths only.

Fitting Cover Number Selection

A U W - 1 2 - S N C - H B 9 0 - 2 4

Material	Fitting Style	Width	Cover Type	Fitting Type	Degree	Radius
A • Aluminum	UW • U-Beam HW • H-Beam	06 • (6") 09 • (9") 12 • (12") 18 • (18") 24 • (24") 30 • (30") 36 • (36")	SNC • Solid Non-Flanged Cover SFC • Solid Flanged Cover VFC • Ventilated Flanged Cover	HB • Horizontal Bend VI • Vertical Inside Bend	30 • (30°) 45 • (45°) 60 • (60°) 90 • (90°)	12 • (12") 24 • (24") 36 • (36") 48 • (48")

Fitting Cover Number Selection

A U W - 1 8 - 1 2 - S N C - R T - 1 2

Material	Fitting Style	Width 1	Width 2	Cover Type	Fitting Type	Radius*
A • Aluminum	UW • U-Beam HW • H-Beam	06 • (6") 09 • (9") 12 • (12") 18 • (18") 24 • (24") 30 • (30") 36 • (36")	06 • (6") 09 • (9") 12 • (12") 18 • (18") 24 • (24") 30 • (30") 36 • (36")	SNC • Solid Non-Flanged Cover SFC • Solid Flanged Cover VFC • Ventilated Flanged Cover	RT • Horizontal Reduce Tee ET • Horizontal Expand Tee EX • Horizontal Expand Cross HSR • Horizontal Straight Reducer HLR • Horizontal Left Reducer HRR • Horizontal Right Reducer HT • Horizontal Tee HX • Horizontal Cross VTU • Vertical Tee Up HYR • Horizontal Wye Right HYL • Horizontal Wye Left	12 • (12") 24 • (24") 36 • (36") 48 • (48")

NOTE: For ET and EX, W2 > W1. For RT, HSR, HLR, HRR, W1 > W2.

* Radius not required for HSR, HLR, HRR, HYR, HYL

Note: For Peaked fitting covers refer to pages 248 to 250

Covers

Fitting Cover Number Selection

Aluminum Cable Tray

Fitting Cover Number Selection

A U W - 4 - 1 2 - S N C - V O 9 0 - 2 4

Material	Fitting Style	Siderail Height	Width	Cover Type	Fitting Type	*Degree	Radius
A • Aluminum	UW • U-Beam HW • H-Beam	4 • (4") 5 • (5") 6 • (6") 7 • (7")	06 • (6") 09 • (9") 12 • (12") 18 • (18") 24 • (24") 30 • (30") 36 • (36")	SNC • Solid Non-Flanged Cover SFC • Solid Flanged Cover VFC • Ventilated Flanged Cover	VO • Vertical Outside Bend VTD • Vertical Tee Down CS • Cable Support	30 • (30°) 45 • (45°) 60 • (60°) 90 • (90°)	12 • (12") 24 • (24") 36 • (36") 48 • (48")

* Not required for VTD nor for CS.

Note: For Peaked fitting covers refer to page 248 to 250

Aluminum Cable Tray

Accessories For Covers

Quantity of Standard Cover Clamps Required

Straight section (6 ft.)	4 pcs.	Tees	6 pcs.
Straight section (12 ft./ 3m)	6 pcs.	Crosses	8 pcs.
Horizontal and Vertical Bends	4 pcs.		

Note: When using the Heavy Duty Cover Clamp, only half the quantity of pieces are required.

IMPORTANT NOTE: "B" in catalogue number indicates this accessory can be used for both styles.

Economical Cover Clamp

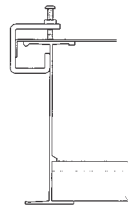

Rigid indoor cover clamp for flat and flanged covers.

Catalogue Number	Material	Siderail Height
ABW-SCC	Zinc Plated Steel	All Sizes

Cannot be used with U-Style fittings.
Can be used with straights and AH fittings only.

Universal Fitting Cover Clamp

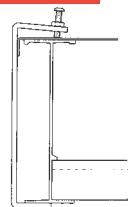
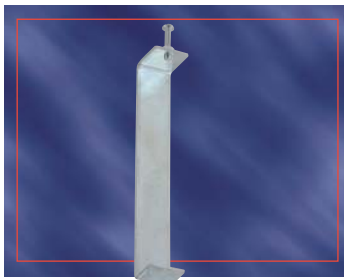

Rigid indoor cover clamp for flat and flanged covers.

Catalogue Number	Material	Siderail Height
ABW(*)FCC	Zinc Plated Steel	4" 5" 6" 7"

(*) Insert siderail height

Heavy Duty Cover Clamp



Wraparound design offers added protection for rugged applications and outdoor conditions.
Hardware included.

Catalogue Number	Material	Siderail Height	Width of Tray
ABW4(*)HCC	Aluminum	4"	06"
ABW5(*)HCC		5"	09"
ABW6(*)HCC		6"	12"
ABW7(*)HCC		7"	18" 24" 30" 36" 42"

(*) Insert width of tray

T&B aluminum cable tray is composed of two distinct systems H-Style and U-Style. These systems are interchangeable.

Accessories For Covers

Aluminum Cable Tray

Extreme Heavy Duty Cover Clamp



Wraparound design offers added protection for rugged applications and outdoor conditions. Hardware included.

Catalogue Number	Material	Siderail Height	Width of Tray
ABW4(*)ECC	Aluminum	4"	06"
ABW5(*)ECC		5"	09"
ABW6(*)ECC		6"	12"
ABW7(*)ECC		7"	18"
			24"
			30"
			36"

(*) Insert width of tray

Heavy Duty Peaked Cover Clamp

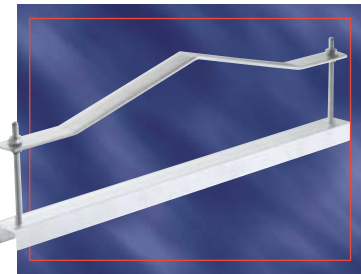

Wraparound design formed to fit peaked cover for outdoor applications. Hardware included.

Catalogue Number	Material	Siderail Height	Width of Tray
ABW4(*)HPC	Aluminum	4"	06"
ABW5(*)HPC		5"	09"
ABW6(*)HPC		6"	12"
ABW7(*)HPC		7"	18"
			24"
			30"
			36"

(*) Insert width of tray

Aluminum
Accessories

Combination Hold Down Cover Clamp

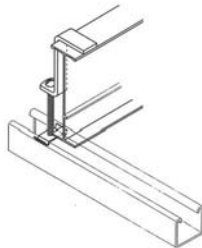

Designed to secure flat and flanged covers with hold down feature.

Catalogue Number	Material	Siderail Height
ABW-4-CCC	Aluminum	4"
ABW-5-CCC		5"
ABW-6-CCC		6"
ABW-7-CCC		7"

Aluminum Cable Tray

Accessories For Covers

Raised Cover Clamp

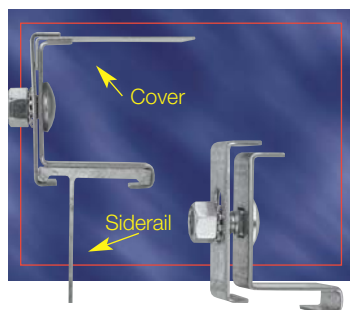

Designed to raise cover above tray for added ventilation.

Catalogue Number	Material	*Cover Series	+Cover Offset
ABW(*) (+) RCC	Zinc Plated Steel	1, 2, 3	1" 2" 3"

(*) Cover series
(+) Cover offset

Peaked End Cap



Used for transition between peaked covers to straight covers.

Catalogue Number	Material	Width of Tray
ABW(*) PEC	Aluminum	6" 9" 12" 18" 24" 30" 36"

(*) Insert Width of tray

Cover Joint Strip

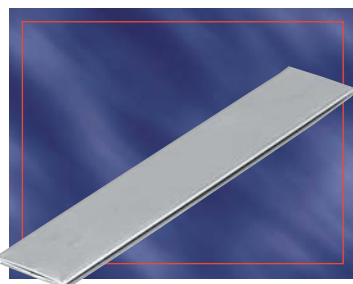

Strip used for joining covers end to end.

Catalogue Number	Material	Width of Tray
ABW(*) SCS	Plastic	6" 9" 12" 18" 24" 30" 36"

(*) Insert Width of Tray

T&B aluminum cable tray is composed of two distinct systems H-Style and U-Style. These systems are interchangeable.

Accessories Splice Plates

Aluminum Cable Tray

Snap-In Splice Plate

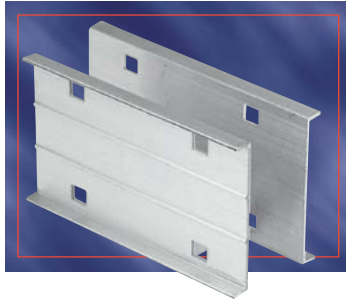

Designed to lock into place for easy alignment and installation.

Packaged in pairs with zinc plated hardware.

Provided as standard with each straight and/or fitting.

Catalogue Number	Material	Siderail Height
ABW-4-SSP	Aluminum	4"
ABW-5-SSP		5"
ABW-6-SSP		6"
ABW-7-SSP		7"

Snap-In Expansion Splice Plate

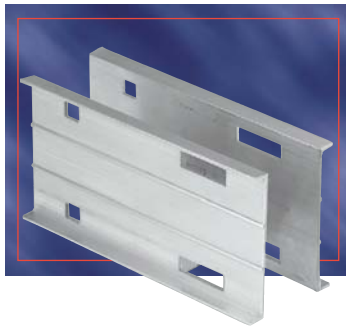

Allows for a 1" expansion or contraction of tray system.

Packaged in pairs with zinc plated hardware.

Catalogue Number	Material	Siderail Height
ABW-4-ESP	Aluminum	4"
ABW-5-ESP		5"
ABW-6-ESP		6"
ABW-7-ESP		7"

Horizontal Adjustable Plate

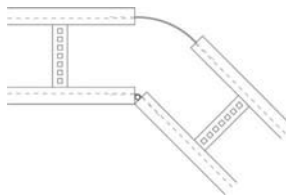
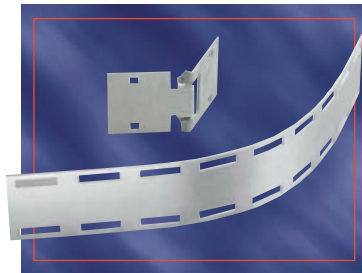

Adjustable hinge plates provide maximum horizontal installation flexibility.

Furnished in pairs with hardware.

Catalogue Number	Material	For Tray Widths
ABW(*)06HAP	Aluminum	6"
ABW(*)09HAP		9"
ABW(*)12HAP		12"
ABW(*)18HAP		18"
ABW(*)24HAP		24"
ABW(*)30HAP		30"
ABW(*)36HAP		36"
ABW(*)42HAP		42"

(*) Insert Siderail Height.

Vertical Adjustable Plate

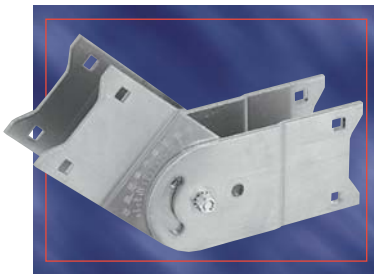

Hinged vertical plates provide maximum flexibility for changes in elevation.

Furnished in pairs with hardware.

Catalogue Number	Material	Siderail Height
ABW-4-VSP	Aluminum	4"
ABW-5-VSP		5"
ABW-6-VSP		6"
ABW-7-VSP		7"

Aluminum
Accessories

Aluminum Cable Tray

Accessories Splice Plates

Box to Tray Plates

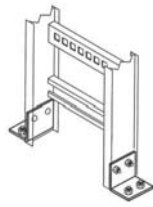
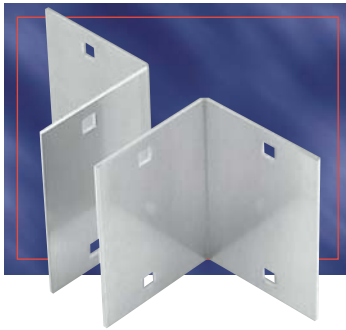

Designed to secure tray to electrical panels or boxes, walls or end supports.

Furnished in pairs with hardware.

Catalogue Number	Material	Siderail Height
ABW-4-BSP	Aluminum	4"
ABW-5-BSP		5"
ABW-6-BSP		6"
ABW-7-BSP		7"

Closure End Plate

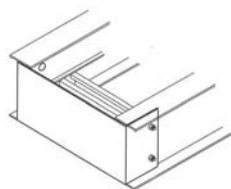
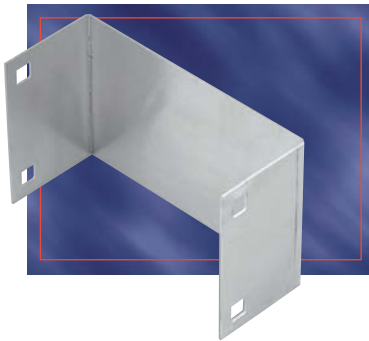

Provides closure for any tray end.

Packaged with hardware.

Catalogue Number	Material	Siderail Height	Widths of Tray
ABW-4(*)-CEP	Aluminum	4"	06"
ABW-5(*)-CEP		5"	09"
ABW-6(*)-CEP		6"	12"
ABW-7(*)-CEP		7"	18"
			24"
			30"
			36"

(*) Insert width of Tray.

Reducing Splice Plate

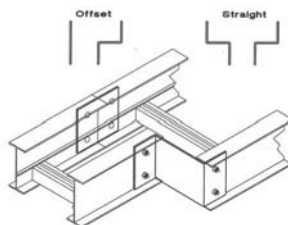

Used in pairs to provide a straight reduction or used with a standard splice plate for an offset reduction.

Packaged with hardware.

Catalogue Number	Material	Siderail Height
ABW-4(*)-RSP	Aluminum	4"
ABW-5(*)-RSP		5"
ABW-6(*)-RSP		6"
ABW-7(*)-RSP		7"

NOTE: (*) For offset reduction: insert width to be reduced
For straight reduction: insert 1/2 width to be reduced (2 required)

Example: ABW-403-RSP = 3" offset reducer.

Step Down Splice Plate

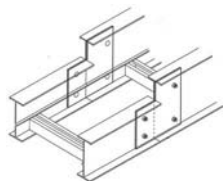
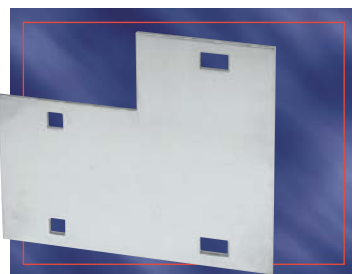

Connects siderails of different heights.

Hardware included.

Catalogue Number	Material	Siderail Height
ABW(*)(**)SDS	Aluminum	4"
		5"
		6"
		7"

(*) Siderail Height 1

(**) Siderail Height 2

NOTE: Siderail Height 1 is greater than Siderail Height 2.

T&B aluminum cable tray is composed of two distinct systems H-Style and U-Style. These systems are interchangeable.

Accessories

Aluminum Cable Tray

Standard Hold Down Clamp



Designed for most indoor installations.
Easy to use and install.
Order 3/8" hardware separately.

Catalogue Number	Material
------------------	----------

SPW-SHC	Zinc Plated Steel
SSW-SHC	316 Stainless

Combination Hold Down / Expansion Guide Clamp

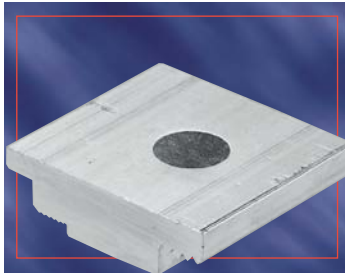

Order 3/8" hardware separately.

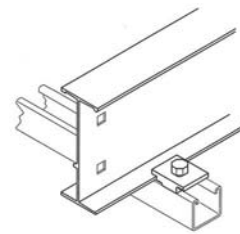
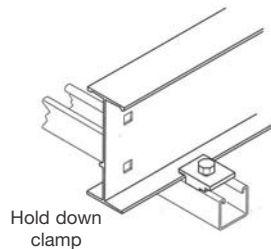

Catalogue Number	Material
------------------	----------

ABW-HEC	Aluminum
---------	----------

Aluminum Tray Hardware

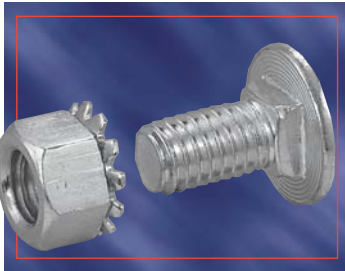

Square shoulder self-positioning carriage bolt.

Catalogue Number	Material	Description
------------------	----------	-------------

SPW-1/4-CB	Zinc Plated Steel	1/4" Carriage Bolt
SPW-3/8-CB	Zinc Plated Steel	3/8" Carriage Bolt
SPW-1/4-HN	Zinc Plated Steel	1/4" Hex. Nut
SPW-3/8-HN	Zinc Plated Steel	3/8" Hex. Nut
SSW-3/8-CB	316 Stainless	3/8" Carriage Bolt
SSW-3/8-HN	316 Stainless	3/8" Hex. Nut
SSW-3/8-HWK*	316 Stainless	316 Stainless Steel Hardware Kit

* Contains 8 bolts, 8 nuts and 8 lockwashers.

Self-Drilling – Tapping Screw



Catalogue Number	Material	Description
------------------	----------	-------------

SPW-10-SCR	Zinc Plated Steel	Self-Drilling – Tapping Screw
------------	-------------------	-------------------------------

Aluminum Cable Tray

Accessories Cable Protection

Drop-Out

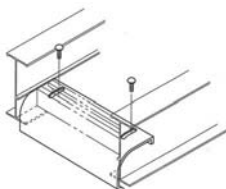

Designed to provide a smooth radiused surface at any position on the tray or trough bottom.

Drop-Outs are easily attached using hardware provided.

Standard radius 4".

Catalogue Number	Description / Material	Widths of Tray
ABW(*)DO	For ladder and ventilated tray / Aluminum	06"
		09"
		12"
		18"
ABW(*)DOS	For solid tray / Aluminum	24"
		30"
		36"

(*) Insert Width of Tray

Wall Penetration Sleeve



Designed to pass through walls and fire walls.

Hardware included.

IMPORTANT:
Not fire rated.
Fire stop not included.

Catalogue Number	Material	Siderail Height	Widths of Tray
ABW(*)(**)WPS	Aluminum	4"	06"
		5"	09"
		6"	12"
		7"	18"
			24"
			30"
	36"		

(*) Insert Siderail Height

(**) Insert Width of Tray

Frame Type Tray to Box Plate

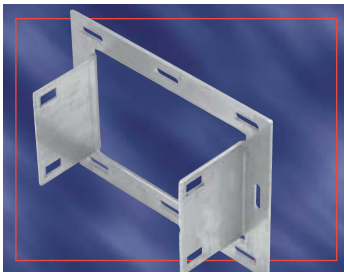

Designed to secure tray to electrical enclosures and panels.

Hardware included.

Catalogue Number	Material	Siderail Heights	Widths of Tray
ABW(*)(**)FBP	Aluminum	4"	06"
		5"	09"
		6"	12"
		7"	18"
			24"
			30"
	36"		

(*) Insert Siderail Height

(**) Insert Width of Tray

Nylon Expansion Pad

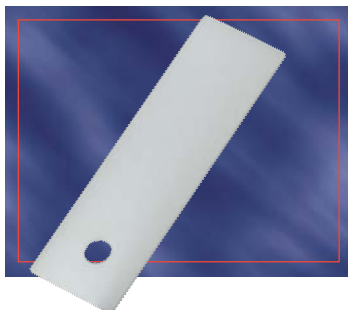

Allows for thermal expansion and contraction of cable trays over supports.

Catalogue Number	Material
ABW-NSP	Natural Nylon

T&B aluminum cable tray is composed of two distinct systems H-Style and U-Style. These systems are interchangeable.

Accessories Barrier Strips

Aluminum Cable Tray

Barrier Strips

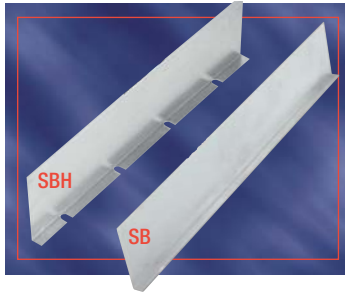

Aluminum barrier strips provide a method of separating cables in tray and trough systems. Easily installed using supplied hardware.

72" barriers are flexible for use with horizontal fittings.

Catalogue Number	Siderail Height	Length
ABW-4-SBH-72	4"	72"
ABW-5-SBH-72	5"	
ABW-6-SBH-72	6"	
ABW-7-SBH-72	7"	
ABW-4-SB-(*)	4"	144"
ABW-5-SB-(*)	5"	3m
ABW-6-SB-(*)	6"	
ABW-7-SB-(*)	7"	

NOTE: 72" barriers provided with 3 SPW10SCR
144", 3m barriers provided with 6 SPW10SCR
(*) Insert length

Inside / Outside Vertical Bend Barriers



Preformed to fit all standard aluminum vertical bends.

Provided with hardware.

Inside Bend Catalogue Number	Outside Bend Catalogue Number	Siderail Height
AUW(*)VIB-(**)-(+)	AUW(*)VOB-(**)-(+)	4"
AUW(*)VIB-(**)-(+)	AUW(*)VOB-(**)-(+)	5"
AUW(*)VIB-(**)-(+)	AUW(*)VOB-(**)-(+)	6"
AUW(*)VIB-(**)-(+)	AUW(*)VOB-(**)-(+)	7"
AHW(*)VIB-(**)-(+)	AHW(*)VOB-(**)-(+)	4"
AHW(*)VIB-(**)-(+)	AHW(*)VOB-(**)-(+)	5"
AHW(*)VIB-(**)-(+)	AHW(*)VOB-(**)-(+)	6"
AHW(*)VIB-(**)-(+)	AHW(*)VOB-(**)-(+)	7"

(**) Insert Bend Angle (+) Insert Bend Radius (*) Insert Siderail Height.

Barrier Strip Clamp

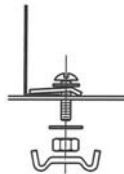
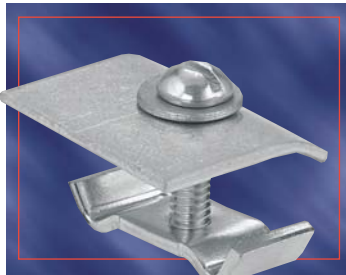

Alternate mounting method for barrier strip mounting.

Barrier strip clamps mount barrier strips to ladder rungs and ventilated bottoms.

Complete mounting hardware supplied.

Catalogue Number	Material
SPW-BSC	Zinc Plated Steel
SSW-BSC	Stainless Steel 316

Barrier Strip Splice

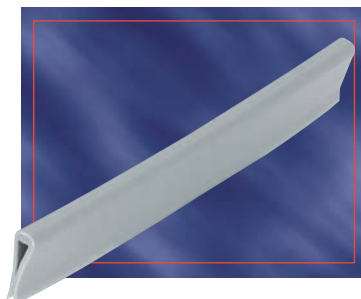

Alignment splice for joining connecting barrier strips.

Catalogue Number	Material
ABW-BSS	Plastic

Aluminum Cable Tray

Accessories

Cable Tray Guide



Expansion guide for single or double runs of cable tray.

No need to field drill of channel or I-beam.

Catalogue Number	Material
SPW-CTG	Zinc Plated Steel
SHW-CTG	Steel Hot Dip

Cable Tray Clamp

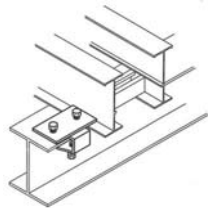
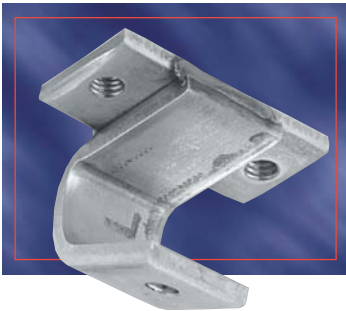

Clamps for single run of cable tray.

No need to field drill the channel or I-beam.

Catalogue Number	Material
SPW-CTC	Zinc Plated Steel
SHW-CTC	Steel Hot Dip

Vertical Tray Hanger

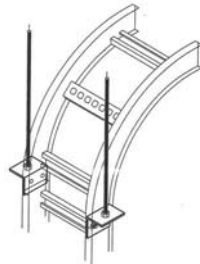

Catalogue Number	Material	Siderail Height
ABW(*)VTH	Aluminum	4"
		5"
		6"
		7"

* Insert siderail height

Hold Down Clamp

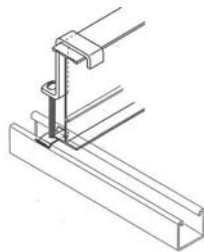

Designed to secure cable tray to support system.

Catalogue Number	Material	Siderail Height
ABW(*)HDC	Aluminum	4"
		5"
		6"
		7"

Note: Hardware included
(*) Insert siderail height.

T&B aluminum cable tray is composed of two distinct systems H-Style and U-Style. These systems are interchangeable.